

# New Era of Oil Well Drilling and Completions — Does It Require An Innovation In Rod Pumping?



## ABSTRACT

A new era of oil well drilling and completions is changing the face of rod pumping forever. Horizontal drilling with multistage hydraulic fracturing often results in very challenging production conditions. Pump placement below the kick-off (i.e., in non-vertical dogleg section), frequent gas slugs, large volumes of flow-back frac sand, significant fluctuations in fluid flow rates, and steep decline curves are examples of the common challenges affecting the production of horizontal wells. Even the most sophisticated conventional pumpjack with an AC motor and variable frequency drive/variable speed drive (VFD/VSD) does not have the precise rod string control required to help mitigate and resolve many of these complex rod pumping issues that are frequently associated with horizontal multistage, hydraulically fractured wells.

Linear pumping units, and more specifically linear hydraulic pumpjacks, have fundamental differences in geometry and control capabilities. Coupled with the fact that both natural gas and AC drive units support the same functionality, linear hydraulic pumpjacks provide the sophisticated rod string control required by today's demanding wells.

This paper will compare and contrast the different rod pumping methods and their abilities to address these production challenges. The paper will also discuss the additional benefits of combining the unique capabilities of a linear hydraulic pumpjack with sophisticated optimization control and remote access. The combination of these three key features provides an unprecedented solution that has the potential to become the next-generation rod pumping technology for cost effectively producing today's challenging wells.

## BACKGROUND

The primary objective of optimizing any artificial lift solution is minimizing the bottom hole pressure to maximize the well-bore inflow at the lowest possible operating cost. Depending on the formation, a newly drilled well could flow on its own for some period of time. Once this initial free-flow production tapers off, an artificial lift system is typically deployed. There are several artificial lift technologies with rod pumping, including gas lift, electrical submersible pumps (ESPs), jet pumps, plunger lift, and progressive cavity pumps<sup>1</sup>. Rod pumping is the most common artificial lift method in North America due to cost efficiency reasons<sup>2</sup>. Bottom hole rod pumps have few moving parts and this simplicity translates into reliability and longevity of equipment.

This paper assumes the reader is already familiar with the basic operation of rod pumping, where a rod string connects a surface lift system to a down-hole pump<sup>2</sup>.

The most common surface equipment used with rod pumping is a pumpjack. The pumpjack is equipped with a prime mover that is either an AC motor or internal combustion engine. In order to maximize production, a pumpjack's stroke speed and stroke length should be adjusted to pump the fluid in the casing down as far as possible while still maintaining a high pump fill. This ideal operating condition minimizes bottom hole pressure, promoting maximum well-bore inflow. However, if the pumping capacity exceeds the production rate of the formation, fluid pound can occur which is one of the most common causes of wear and damage in a rod pumping system. Due to the mechanical nature of stroke speed and stroke length adjustments on a pumpjack, finding and maintaining the ideal setting on each well over time can be an expensive proposition.

One pumpjack alternative is a hydraulically actuated cylinder which moves the rod string up and down in a similar manner<sup>3</sup>. The simplest version would raise the hydraulic piston until it hits the upper limit of the cylinder then gravity would return it to the lower limit where the cycle would repeat. Position sensors can be added so that the cylinder will turn around when it reaches a specific position along the stroke length. This prevents physical contact between the piston and the inside of the cylinder, extending equipment life. The position sensors can also be manually moved to increase or decrease the stroke length up to the length of the cylinder as well as to change the position offset of the stroke.

The linear hydraulic pumpjacks used are typically configured with an on/off style valve and solenoid combination where the cylinder is receiving maximum flow on the upstroke, pressure but no flow to hold a set position, then maximum flow purge on the down-stroke. The more advanced linear hydraulic pumpjacks use continuous position measurement and a variable output pump to precisely control the polished rod velocity and position.

## THE NEW ERA OF OIL WELLS

One might consider the definition of a new era oil well as either a shale well and/or a well that is horizontally drilled and completed<sup>4</sup>. With today's wells, producers are striving to get even more production from their reservoirs. Wells are being drilled horizontally and pumps landed anywhere from the vertical section, above the kick-off point, to severe angles well into the dogleg section but all are typically above the perforations. This can commonly result in excessive gas problems such as gas locking or gas interference, depending on where the pump intake is compared to the perforations. Fracking is being used extensively to promote higher well-bore inflow. This leads to an excess of frack sand and debris which will usually make its way through the down-hole pump during production flow-back or pumping.

Once in the pump, it may start clogging the traveling and standing valves or simply accumulate inside the pump, leading to a decline of pump efficiency and ultimately loss of production.

Regardless of how a well is completed, rod pumping equipment, like other artificial lift techniques, can encounter an array of issues over its lifetime. These issues range from hardware failures (e.g. surface equipment failures, parted rods, worn tubing, traveling and standing valve issues, etc.) to down-hole operational issues (e.g. wax build-up, gas interference, gas locking)<sup>5</sup>. Hardware failures can be partially mitigated with proper rod string design, diligent preventive maintenance, controlled pumping parameters, and regular monitoring but they can never be completely eliminated.

Many of the operational issues related to the well-bore are harder to avoid because they are unpredictable. Continuous monitoring and timely issue resolution are keys to minimizing the impact of these issues.

These rod pumping issues existed in vertically drilled wells. With the introduction of horizontal drilling and multistage fracking, the frequency and severity of rod pumping issues has increased significantly, especially in the transient phase of a well's life. To maintain optimum pumping conditions and minimize unplanned downtime (i.e., maximize return on investment), it is more critical than ever to have the ability to quickly identify issues as well as the capability to resolve them in a cost-effective and timely manner. The most common adjustments required to resolve issues are rod string velocity, rod string position and stroke length. This paper will focus on comparing the capabilities of pumpjacks and linear hydraulic pumpjacks to control/modify these parameters and how this can be used to address common issues.

***With the introduction of horizontal drilling and multistage fracking, the frequency and severity of rod pumping issues has increased significantly, especially in the transient phase of a well's life***

## COMPARISON OF PUMPJACKS AND LINEAR HYDRAULIC PUMPJACKS

### Pumpjacks

By their nature, pumpjacks move in a sinusoidal pattern with the polished rod constantly accelerating or decelerating throughout the stroke. Without installing additional control hardware, operational changes on a pumpjack require on-site mechanical adjustments. Small, short-term stroke speed adjustments, typically for testing purposes, are possible by changing engine RPM but generally stroke speed changes require a change to the gear reducer sheaves that connect the motor to the gearbox.

Stroke length changes on a pumpjack are also done via on-site mechanical changes. Stroke length is determined by the position of the Pitman Arm relative to the crank. To change stroke length, the pumpjack must be shut down and a small crane must be used to reposition the Pitman Arm on the crank. The combination of equipment costs, labor costs and production downtime can make these changes very expensive.

Rough calculations, taking into account expected production and average pump fill, can be done to help determine optimum stroke speed and stroke length to match surface production to the well-bore inflow. However, this is only an estimate and often there is trial and error required to determine the optimal gear ratio. In addition, well-bore dynamics could result in the need to make relatively frequent changes to maintain optimum production. There are also certain equipment limitations that might not allow for optimal stroke settings and other techniques have been developed over time. An example would be a simple on/off timer used to periodically shut a unit down to prevent poor pump-fill and possible damage to the rod string.<sup>2</sup> This technique also has implications since shutting in a well halts production which is not as efficient as constantly producing a well. There can also be issues with sand and debris settling into the pump, potentially causing it to seize after a period of downtime.

An alternative to a timer would be an AC motor with a VFD. This could eliminate the need for start/stop cycles (which is taxing on the equipment) as well as consume only the required power to keep the well stroking in an automated fashion with the help of a pump off controller (POC).<sup>6</sup> AC power availability is the biggest limitation to a VFD-based solution. There are a significant percentage of pumpjack installations that use an internal combustion engine with no equivalent functionality.

### Linear Hydraulic Pumpjacks

Operation of a linear hydraulic pumpjack is significantly different than a pumpjack. With a linear hydraulic pumpjack, the prime mover is mechanically decoupled from the mechanism that strokes the rod string. The prime mover is used

to pressure up hydraulic oil which can then be manipulated as necessary to control the movement of the hydraulic cylinder. With basic linear hydraulic pumpjacks, position sensors are used to define the stroke length. A change in stroke length requires an on-site repositioning of the sensors but does not require a crane or other heavy equipment as with a pumpjack. Depending on the hydraulic control valves used, the stroke speed may or may not be configurable. On systems that do not have proportional flow control, time between strokes can usually be adjusted as a crude way to change the average strokes per minute. One of the key benefits of linear hydraulic pumpjacks is both AC motor and internal combustion engine-driven systems have the same rod string control capabilities.

## **TECHNOLOGY ADVANCEMENTS**

### **Remote Visibility and Two-Way Control**

In recent years, it has become more common to outfit artificial lift systems with some type of controller that may include a radio system for connection to a remote host. The capabilities of these systems vary widely by technology and vendor and can range from view only to full two-way control. Although much of the value remains with the method of operation, remote surveillance/control does provide significant additional value and is very important for fully optimizing challenging wells.

Without remote surveillance/control technology, an oil field operator would typically have a daily route taking them to each well site sequentially to check the status. They would have no indication as to the health of that well until they arrived at the site. The introduction of a supervisory control and data acquisition (SCADA) system allows the operator to remotely monitor and potentially adjust pumping parameters without traveling to the site. The operator can also use the technology to help prioritize their daily tasks, allowing them to focus on the key issues<sup>7</sup>.

A SCADA system would also typically provide some type of alarming functionality, either real time with call-out capabilities or time delayed based on a set polling interval. This informs the operator that an error condition has occurred, allowing them to re-prioritize their activities as required. Without this, the operator would travel their set route, discovering the error condition only once they arrived on-site. This method of operation could result in undetected error conditions extending to several hours or even a full day.

The type and complexity of data collected and stored on a SCADA host can vary significantly by technology and vendor. It could be as simple as a run status or as complicated as dynamometer cards. Local controller data storage capabilities are often very limited. Adding a remote host introduces the ability for long-term data trending. These long-term trends are key to identifying changes in a well's behavior that could be an indication of a current or developing issue. This scenario makes long term data trending an important part of an effective alarm management strategy.

Remote surveillance/control capabilities become even more valuable for remote sites, sites without year-round access, or during times of inclement weather when driving is too dangerous or not possible. In addition to the well optimization benefits, remote access has a secondary benefit related to employee safety. Based on a study done in the US, motor vehicle accidents are the leading cause of work-related fatalities in the oil and gas extraction industry<sup>8</sup>. SCADA systems do not eliminate the need for travel but, if simple parameter changes or restarts of stalled engines can be done remotely, this remote capability can help reduce the number of trips required.

### **Conventional Pumpjacks**

For many years now, VFDs have been used on AC motor-driven pumpjacks. Basic VFDs control only the stroke speed, whereas the more advanced units can control the pumpjack's upstroke and down-stroke speeds independently. There are even more advanced models that can support configurable speeds throughout the entire upstroke or down-stroke. This allows for custom speed profiles to be developed<sup>9</sup>. With these systems, the surface stroke can be manipulated in such a way that the polished rod does not have to follow the normal sinusoidal velocity associated with the pumpjack geometry (Figure 1). This can be used to precisely tune each system to pump a well as necessary, whether to maximize stretch (as in a fiberglass rod string) or to minimize peak stress throughout the stroke.

The presence of a VFD substantially improves the capabilities to optimize the production from a pumpjack. However, because these benefits are only available on AC-driven units, fields with a mix of AC and internal combustion engines will not get the full benefit and will need different optimization strategies for different wells.

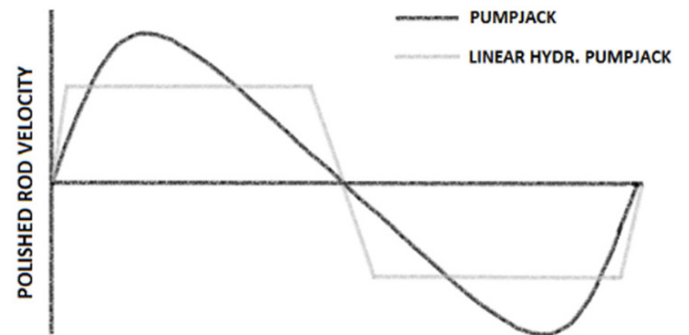

Figure 1. Polished rod velocity profiles of pumpjacks and linear hydraulic pumpjacks.

## Linear Hydraulic Pumpjacks

There have been several significant technology advancements with linear hydraulic pumpjacks over the past several years. One of the more significant advancements is the replacement of the position sensors with continuous position measuring systems such as a linear transducer. This enhancement allows the optimization controller to completely customize both the upstroke and the downstroke, resulting in very precise rod string control. Combine this with the transition to a proportional control valve (as opposed to an on/off solenoid-style valve) and the surface stroke becomes highly customizable and can be tailored to each well's requirements.

The combination of remote visibility, two-way control and adjustable stroking patterns (stroke speed and velocity profile) make the VFD-equipped pumpjack and linear hydraulic pumpjacks (with position measurement capabilities) the leading contenders for addressing the challenges of today's horizontally drilled, multi-stage fractured wells.

However, the limitations that even the most advanced conventional pumpjacks have related to position control means that linear hydraulic pumpjacks have the best overall feature set for addressing these challenging production scenarios.

## PRECISE ROD STRING CONTROL — A SIGNIFICANT ADVANTAGE

One of the key parameters in the optimization of an oil well is control and adjustment of rod string movement. As highlighted earlier, traditional pumpjacks are somewhat limited by their geometry because rotational velocity of the prime mover/gear box arrangement is converted to linear velocity of rod string via mechanical connections of the crank, pitman arm and walking beam. Any change to rod string velocity requires a change in the prime mover rotational velocity or a mechanical change of the pumpjack components. A variable frequency drive on an AC-driven pumpjack can provide some variation in prime mover RPM but the variability is still somewhat limited.

Linear rod pumps, such as hydraulic pumpjacks, do not have this geometric limitation. By using hydraulics rather than a mechanical connection between the prime mover and the linear movement of the rod string, precise rod string control can be achieved without any adjustment to the output of the prime mover. The hydraulic system can provide proportional control during any part of the pumping cycle.

There are several other benefits of eliminating the direct coupling of the prime mover output from the rod string motion. One example is the ability to stop the pumping cycle at any time, move to any position and hold that position without any mechanical intervention (i.e., manual braking or locking mechanisms). This enables automated traveling and standing valve tests (without any local intervention). This ability extends to easily changing the stroke length by changing the top and/or bottom position limits, often with just a setpoint change on the optimization controller. If a remote SCADA communication system is available, this change can be made remotely without the need for a site visit or any production downtime.

Halting the stroking action mid stroke and holding position is also useful for emergency shutdowns due to rod hang-ups where continued force on the rod string could cause damage to the rods, tubing, down-hole pump or surface equipment. Operation with a classic linear hydraulic pumpjack without a continuous position sensor would not see this benefit as the

system would rely on low and high pressures or proximity switches to change stroking direction. A standard pumpjack with a combustible engine would not be able to stop quickly due to the momentum of the counterweights. A VFD-assisted pumpjack can slow down very quickly but would be unable to automatically hold its position mid stroke due to either rod load or the counterbalance weights (depending on balancing) as there is no automatic brake.

Another example of the benefits of precise rod string control is temporary, short-term changes to the way a well pumps. Transient issues are often best addressed with temporary rod string changes. Whether setting a pump on tap to clear light debris or shortening stroke length to clear more significant debris is necessary, a linear hydraulic pumpjack is capable of quick changes to deal with dynamic well issues. Leaving a pump on tap or with an altered stroke length is not ideal after the condition has cleared which means the ability to remotely and easily change the pumping parameters can be a significant advantage.

In horizontal/shale wells, higher output of oil and water also brings higher quantities of gas. Despite lower fluid velocities around the well-bore, sand can also be a major issue as it makes its way into the pump (especially if the horizontal section has not been sufficiently packed with gravel). With all these potential pumping challenges, there is no one 'perfect setting.' Having the flexibility to make frequent and remote parameter changes can have a significant impact on a well's production. The following sections will analyze how each rod pumping solution addresses the more prevalent issues in horizontally drilled wells.

### **Example 1: Rod String Velocity Control - Leaking Valves, Light Sand and Debris**

Although gravity may help seat the traveling and standing valves in a vertical well, it is not required. Fluid flow and pressure differential should be sufficient to operate the valves. Landing pumps at a steep incline of 45 to 70+ degrees virtually eliminates any gravitational assistance there may have been with valve seating.<sup>10</sup> To improve valve seating, spring-loaded cages could be used in the down-hole pump but these additional parts add more complication because of the potential of getting fouled up with sand or other debris. To improve valve operation, more flow (i.e., higher pressure differential) is required and increasing the acceleration of the down-hole plunger can be very effective.

When the valves in the down-hole pump become fouled up with debris or other impediments, the fluid weight in the tubing does not effectively transfer between the standing and traveling valves. Depending on which valve is stuck open, the measured rod string weight may be too low (traveling valve not seating on upstroke) or too high (standing valve not sealing on downstroke). To clear a traveling or standing valve of debris, it has been found that increasing the upstroke plunger velocity or downstroke plunger velocity respectively can be very effective.

A possible explanation for this is the increased velocity of the fluid passing through the valve openings (traveling or standing) flushes out the debris which was interfering with the valve operation. Additionally, it is believed that gently tapping the pump can be helpful. This is likely due to the vibrations generated by the tap jarring the ball and potentially dislodging the debris.

Continuous stroking is recommended in wells that are known to produce sand and debris. This is because, when pumping is stopped, the sand in suspension in the column of fluid in the tubing settles to the bottom, plugging up the down-hole pump. When the well is restarted, the sand that has settled down between the plunger and the barrel can result in pump damage or a seized pump.

#### **A. Resolution Options with Pumpjack with VFD**

An AC-powered pumpjack equipped with a VFD could manipulate the upstroke plunger velocity to improve traveling valve seating while maintaining a set stroke per minute. If the well was spaced relatively close to tap, it is often possible to over speed the downstroke and overstretch the rods to reach tap similar to the linear hydraulic pumpjacks with advanced control. Otherwise, a manual adjustment to the rod clamp position is necessary to lower the rod string to enable a physical tap.

#### **B. Resolution Options with Pumpjack without VFD**

There is currently no way to manipulate just the acceleration of a polished rod on a pumpjack driven

by a combustible engine or an AC motor without a VFD. It is also not possible to control the upstroke and downstroke speeds independently. The gearing can be changed to increase overall stroke speed but that can create other problems, such as rod buckling and excessive wellbore fluid draw-down requiring frequent stops to prevent fluid pound. To put a well on tap, the polished rod spacing needs to be adjusted such that tap occurs during regular operation or when pumping speed is increased (as explained above). Otherwise, a manual adjustment to the rod clamp position is necessary to enable a physical tap (like the conventional pumpjack example above).

### C. Resolution Options with Basic Linear Hydraulic Pumpjack

Basic linear hydraulic pumpjacks operate with an on/off solenoid-style valve control and accelerate to peak polished rod velocity almost immediately on the upstroke. A crude adjustment is possible by setting the valve to open to a different position on the upstroke versus the downstroke, directly affecting upstroke speed versus downstroke speed. Provided the rod string is spaced properly, tapping can be induced by simply lowering the bottom position sensor. These position changes are manual and would require a site visit.

### D. Resolution Options with Advanced Linear Hydraulic Pumpjack

As explained earlier, the most significant difference between advanced and basic linear hydraulic pumpjacks is the continuous position monitoring as compared to just top/bottom proximity sensors. With continuous position monitoring, the acceleration/deceleration zones can be adjusted independently. The upstroke and downstroke plunger velocities can also be adjusted independently. As a result, it is very simple to make the required plunger velocity changes to address whatever issue is impacting valve seating (refer to appendix: cases 1A, 1B and 2). Setting a well on tap can also be done simply by lowering the bottom position set-point via the local HMI or remotely via a SCADA system (provided the rod string is spaced to tap at its lowest operating position during the initial installation).

## Example 2: Position Control — Potential Sand Management

From time to time, a larger than normal amount of sand/debris can be drawn into the down-hole pump and not immediately produced up the tubing, resulting in an accumulation inside the pump. This accumulation can have a very severe impact on pump operation and, if left unresolved, could restrict or completely block fluid flow into or out of the pump. Sand may accumulate in the bottom of the pump to the point that it interferes with the valves and/or plunger operation. Continued accumulation could result in the pump hitting the sand prior to reaching the bottom of the stroke, putting the rod string in compression. This condition appears on a pump card as a tap but is actually happening inside the pump rather than normal tap on top of the pump (Figure 2). The same situation can happen at the top of the pump if sand or debris accumulates above the plunger. This situation can also be seen on the pump card as an increase in rod load, above normal levels, near the top of the stroke. If left unresolved, the packing of sand or debris can be significant enough to restrict or completely block off fluid flow from the pump. Typically, a well work-over is required to deal with a sanded pump.

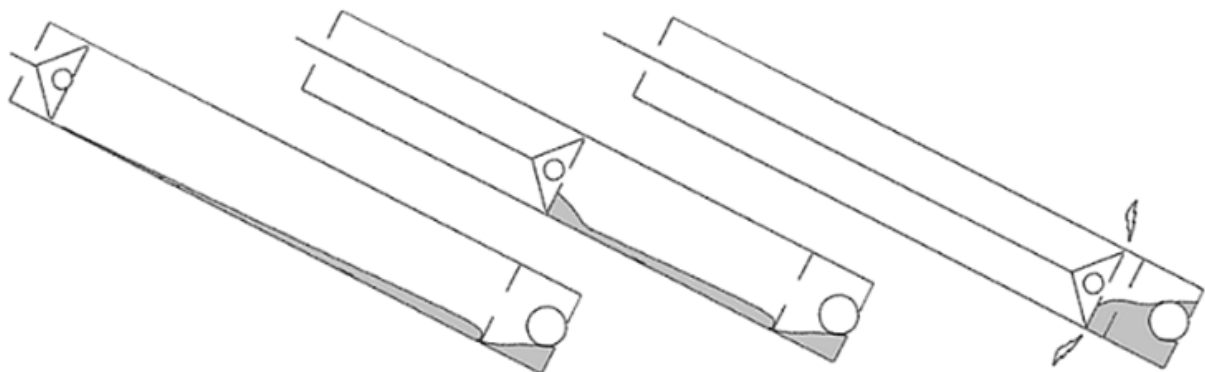

Figure 2. Sand/debris accumulations.

A shortened stroke length can be used to attempt to clean out a pump that has not yet sand locked (i.e., sand accumulation that blocks plunger movement or blocks the flow of fluid into or out of the pump). For accumulations at the bottom of the pump, the bottom stroke position should be raised, ensuring the plunger no longer contacts the sand/debris (refer to the pump card to determine this position). This prevents further sand compression and causes the sand to loosen and mix via agitation with the production fluid. By continuing this action, the pump can be cleaned out fairly quickly, depending on the quantity of sand in the pump. If the accumulation is at the top of the pump, the top stroke position should be lowered to the point of no contact. As with accumulations at the bottom, the agitation from continuing to pump (without further packing) can loosen the sand/debris, enabling it to mix with the production fluid and be washed out of the pump. If caught early enough, the probability of successfully cleaning out a sanded pump with this technique is much higher (increasing the odds of avoiding the work-over costs).

#### **A. Resolution Options with Pumpjack with VFD**

Changing the stroke length and position offset is possible on a pumpjack. However, it is a time and labor intensive procedure. With a VFD, it is possible to get some overstretch at the top and bottom of the stroke but, even with the overstretch feature, it is impossible to short-stroke a pumpjack without stopping and manually adjusting the pitman arm or polished rod.

#### **B. Resolution Options with Pumpjack without VFD**

On a combustible pumpjack unit, the same limitations apply as the VFD-equipped systems. Either the carrier bar clamp would need to be lowered on the polished rod (to raise the stroke region higher) or the full stroke length would need to be shortened.

It may not be possible to simply raise the stroking region, depending on the length of the downhole pump. If the surface stroke length exceeds the downhole pump length, changing the stroke top position could inadvertently unseat the pump. It is possible to install a clamp on the polished rod below the carrier bar to shorten the stroke. This essentially prevents the polished rod from descending once the clamp hits the top of the stuffing box. This technique is not recommended because it introduces a large shock to the wellhead and stuffing box and completely removes the weight of the rods from the pumpjack on the downstroke. This also leads to the possibility of stalling since there is a sudden lack of rod weight to bring the counter weights to the top position.

#### **C. Resolution Options with Basic Linear Hydraulic Pumpjack**

A linear hydraulic pumpjack with basic top/bottom position sensors can provide a shortened stroke. The position sensors can be moved manually to either raise the bottom position or lower the top position. If the system does not provide pump cards, a hydraulic pressure gauge can be used to determine where contact with the debris begins. The adjustments on this type of system are manual and require a trip to the site. There will also be some trial and error involved to find the correct sensor settings. Multiple site visits may be required to determine if the debris has cleared and to reset the position sensors back to their original locations.

#### **D. Resolution Options with Advanced Linear Hydraulic Pumpjack**

A linear hydraulic pumpjack with precise, continuous position sensing can have its top and bottom setpoints adjusted either locally with the HMI or remotely with a SCADA system. The pump cards can be used to determine the new setpoints to avoid contact with the sand/debris.

After a certain period of time, the stroke setpoints can be slowly returned toward the original settings and the pump card can be referenced for instant feedback on whether the sand has been cleaned out. All these adjustments can be made remotely if a SCADA system is installed (refer to appendix: cases 3 and 4)

### **Example 3: Speed Control — Gas Interference, Gas Locking and Rod Stress**

Today's oil wells seem to have more pronounced issues with gas interference, gas locking and rod stress. This section



compares the most common rod pumping solutions relative to their ability to effectively mitigate these issues. First, some general background on gas interference, gas locking and rod stress is required.

Produced gas can cause production issues in varying degrees depending on where and how the downhole pump is set in a horizontal well, whether it is vertical (or at an angle just before kick-off) or at an angle post kick-off (Figure 3).

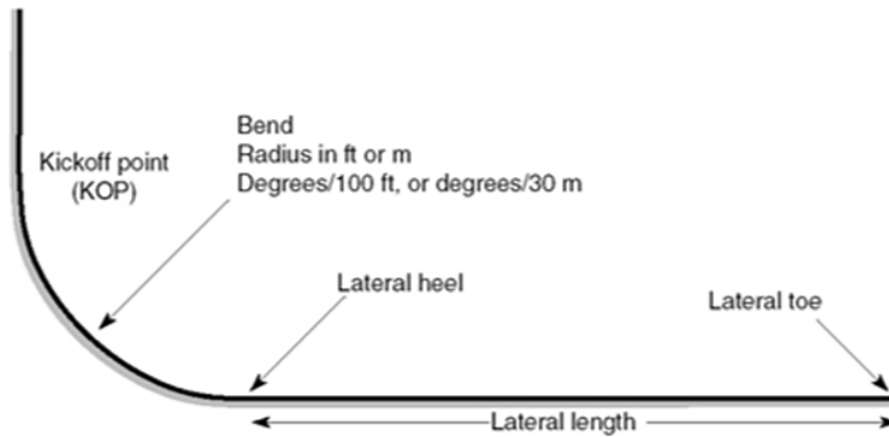

Figure 3. Kick-off point where deviation starts after vertical section.

If set vertically before the kick-off point, there is no natural sump to use to separate the gas from the fluid since the pump is well above the perforations. To help mitigate issues with excessive gas, a gas anchor or a packer can be installed<sup>11</sup>.

They perform in a similar manner as a surface gas separator, providing a space for the gas to leave the fluid before the fluid makes its way into the downhole pump. These gas separators have specific flow ratings where they operate most efficiently. If production exceeds the gas separator flow rating, gas starts entering the pump which typically causes pump efficiency to drop. To achieve higher pump efficiency during initial production, the surface equipment and downhole separator should be sized for similar production rates.

If the pump is landed after the kick-off, or in general at an angle, then a natural sump is formed. Gas and liquid will separate in non-vertical casing, with gas migrating to the top, above the liquid (Figure 4). The tubing will be resting on the bottom of the casing and the pump will ideally be fully submerged in liquid to maximize the benefit of the natural separation<sup>12</sup>. With this pump landing configuration, gas interference and gas locking issues are thought to be less severe because the pump intake is submerged with the separated gas flowing above it.

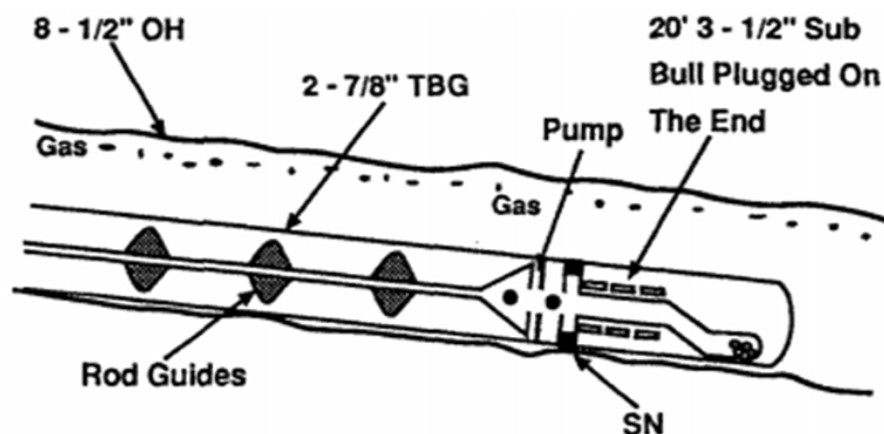

Figure 4. Typical setup for pumping a horizontal well in the deviated portion of the hole<sup>12</sup>.

A common procedure for addressing a gas-locked pump is to lower the polished rod to put the pump 'on tap' (physically contacting the top of the downhole pump). The potential theory is that this helps fix a gas locked pump by:

1. Creating enough shock or vibration to cause fluid leakage from the tubing, down past the plunger and into the pump, to displace some of the gas.
2. Shaking the traveling valve enough to briefly unseat it and allow some of the gas to escape up the tubing.

When a pump is on tap, it also guarantees the traveling valve is as close as possible to the standing valve which is the position that has the highest compression ratio<sup>13</sup>. Over time, there is also leakage between the barrel and the plunger. This results in additional fluid between the valves, leading to a higher compression ratio and an increased possibility of opening the traveling valve to allow gas to escape up the tubing.

If the above method is unsuccessful, another strategy is to physically stop the pumpjack at the topmost position and manually lock it in place. This gives the fluid a chance to leak between the barrel and plunger to displace some of the gas in the pump. Shutting in the well may also increase formation pressure to help overcome the gas pressure in the pump and open the standing valve to the point that normal pumping can resume. This process typically requires manual intervention to stop and lock the polished rod in the highest position and to restart again hours later.

Finally, another option is to employ a service rig to manually long-stroke the polished rod and, by extension, the downhole pump to maximize compression and break the gas lock.

In addition to gas interference, there are several other factors that need to be considered in the completion and operation of horizontal wells. Rod guides should be carefully selected to reduce rod wear from contact with the tubing. Rod buckling is also a much greater concern in horizontal wells. Sinker bars should be installed at the bottom of each vertical section to keep tension on the rods during a downstroke. A faster upstroke and slower downstroke also help prevent rod buckling as well as reduce slippage in the pump. However, a slower upstroke puts less tension on the rods which is useful for managing stress in medium to large wells with large plungers.

The flexibility to make these parameter changes to help address the challenges will be dependent on the type of artificial lift system deployed as summarized on the next page.

#### **A. Resolution Options with Pumpjack with VFD**

By using an AC motor with a VFD on a conventional pumpjack, one can finely tune the pumping speed to not exceed the production rate of the downhole separator. Certain VFDs are also capable of different upstroke versus downstroke speeds, meaning a slower downstroke can be implemented to help keep the rod string in tension while the faster upstroke keeps the overall average strokes per minute at the desired rate. This configuration helps mitigate rod buckling in wells with severe doglegs and pumps landed at steep inclines. VFD features can also be used to address gas interference. For example, increasing the downstroke speed or tapping the pump as mentioned in the speed control section (if spaced properly). The pumpjack can also be locked in the top position to attempt to use fluid leakage to break the gas lock (as explained above).

#### **B. Resolution Options with Pumpjack without VFD**

A combustible-driven (or AC-driven with no VFD) pumpjack can be set, ensuring production at the surface does not exceed the rating of the downhole separator by changing overall stroke speed. Buckling tendencies will need to be managed with sinker bars or slower overall stroke speed (via manual pumpjack adjustments). To break gas lock, the well must be spaced to tap or to leave in the top position

as with a VFD-equipped unit. This would require a site visit to make physical changes to the system setup.

### **C. Resolution Options with Basic Linear Hydraulic Pumpjack**

A basic linear hydraulic pumpjack can be set to not exceed the rating of the downhole separator. This can be done by varying the dwell time between strokes, even if the polished rod velocity is not configurable. Alternatively, the output flow rate of the hydraulic pump/valve combination can be reduced via a manual adjustment. The maximum downstroke speed can also be reduced with a manual valve adjustment to help mitigate buckling. To break gas lock, the bottom position sensor could be manually lowered to put the pump on tap (if spaced appropriately). The polished rod can also be raised to the top position, as on the pumpjack, with either a long, top dwell setting or manually. The pump can then be restarted either manually or automatically, once enough fluid has leaked into the pump to break the gas lock.

### **D. Resolution Options with Advanced Linear Hydraulic Pumpjack**

Advanced linear hydraulic pumpjacks with continuous position sensing can be set to not exceed the maximum production rating of the downhole separator. This is done with either dwell times or by directly controlling the polished rod velocity. The hydraulic flow characteristics can be configured to gently drop the polished rod at a prescribed velocity to mitigate buckling and manage rod stress. To break a gas lock, four methodologies have been tested on advanced linear hydraulic pumpjacks, including:

1. The most frequently used strategy is simply a temporary increase in downstroke speed. It is speculated this action results in a higher compression ratio to help pop open the traveling valve, allowing the gas to escape. There is also a possibility that the higher stroke rate causes more vibration in the rod string, resulting in more fluid leaking past the plunger and into the barrel. This would aid in compression on subsequent strokes, forcing the traveling valve open (refer to appendix: case 5).
2. The second strategy is to alternate between fast up for 'X' strokes followed by fast down for 'Y' strokes. The exact mechanism for breaking gas lock is not well understood but it has been shown to be successful in some situations.
3. The third strategy is to lower the bottom setpoint, enabling the pump to be set on tap (as described previously).
4. If the first three methods do not work, a fourth strategy is to enable a feature that sets and holds the polished rod at its highest position and automatically restarts pumping after a pre-set number of hours. This can be achieved without having to visit the site.

During the research conducted for this paper, the methodologies were only tested by Emerson's DeltaV™SaaS SCADA engineers on the advanced hydraulic pumpjack configuration and not on the pumpjack with VFD. However, it is perceived that the first three of these four methodologies, that might address gas locking, would also be applicable on a pumpjack with VFD. It should be noted that 'gas lock fixing' methodologies, one through four, do not always work and Emerson is continuing to experiment with precise rod string control capabilities to see if gas locking can be more systematically 'fixed' in more situations and cases.

## SUMMARY

The table below summarizes how the different rod pumping systems solve each issue.

	Pumpjack with VFD	Pumpjack without VFD	Basic Linear Hydraulic Pumpjack	Advanced Linear Hydraulic Pumpjack
<b>Non-Seating Valves Light Sand/Debris</b>	Quick upstroke and tapping; possible remotely	Increase stroke speed; manual local adjustment	Quick upstroke and tapping; manual local adjustment	Quick upstroke and tapping; possible remotely
<b>Excess Sand Management</b>	Shorten or raise the stroke region higher; manual local adjustment	Shorten or raise the stroke region higher; manual local adjustment	Shorten or raise the stroke region higher; manual local adjustment	Shorten or raise the stroke region higher; possible remotely
<b>Gas Interference Management</b>	Match production to the downhole gas separator; possible remotely	Match production to the downhole gas separator; manual local adjustment	Match production to the downhole gas separator; possible remotely	Match production to the downhole gas separator; possible remotely
<b>Gas Locking Resolution</b>	Quick downstroke and tapping, extended stop at top of stroke; tap possible remotely, manual tap local only	Increase the stroke length to tap, extended stop at top of stroke; manual local adjustment	Quick downstroke and tapping, extended stop at top of stroke; manual local adjustment	Quick downstroke and tapping, extended stop at top of stroke; possible remotely
<b>Rod Stress Management</b>	Slow the downstroke to prevent buckling; possible remotely	Decrease stroke speed; manual local adjustment	Slow the downstroke to prevent buckling; manual local adjustment	Slow the downstroke to prevent buckling; possible remotely

## DISCUSSION

A pumpjack equipped with an AC motor and VFD provides greater flexibility than one without a VFD to assist with effectively pumping today's shale or horizontal wells. The ability to adjust upstroke and downstroke characteristics independently is crucial for maximizing production potential. Going a step further and adding the ability to modify parameters throughout the upstroke and downstroke adds greater flexibility to control a rod string and, by extension, the downhole pump.

Linear hydraulic pumpjacks, by their nature, provide the same level of rod string control regardless of the powerpack type (i.e., AC or combustible). As a result, maximum optimization can be employed regardless of grid (AC) power availability and without the added cost of a generator. As for stroke length adjustments, the linear hydraulic pumpjack allows for instantaneous control over stroke length and position whereas a pumpjack (with or without a VFD) requires labor-intensive local intervention and downtime. Likewise, stopping and holding a stroke position (other than maximum top) is not possible on a pumpjack without a mechanical brake that must be engaged and disengaged locally. The ability of the linear hydraulic pumpjack to stop and hold any position is very useful when performing traveling and standing valve tests. The results of these tests will provide an indication as to the performance of the downhole valves. In turn, this provides information useful in determining if some cleanout action is required to restore pump efficiency. Consistently poor results in these tests could indicate that a pump change is required or that long-term operational changes must be implemented to improve pumping efficiency.

Precisely controlled linear hydraulic pumpjacks are more flexible than their standard two-sensor or no-sensor counterparts. The addition of a SCADA system with an advanced linear hydraulic pumpjack provides even more flexibility for identifying and resolving common rod pumping issues by taking full advantage of the system's capabilities for remote control.

## CONCLUSIONS

Pumpjacks equipped with AC motors/VFDs and linear hydraulic pumpjacks with continuous position sensing are similarly capable of remotely and precisely controlling polished rod velocity and are therefore useful at dealing with light debris and gas interference issues that commonly occur in horizontally drilled wells. Linear hydraulic pumpjacks with real-time position and speed control capabilities also have the benefit of precise position control, enabling features such as automated valve tests and the cleaning out of moderate amounts of sand from a downhole pump. As an added benefit, these features are not restricted to sites that have AC power. They can also be exploited on a linear hydraulic pumpjack with a combustible powerpack.

New sophisticated hydraulic solutions deliver unprecedented capability beyond the most sophisticated conventional pumpjacks. These features are critical for operating the new breed of horizontally drilled and hydraulically fractured oil wells. Their unique capabilities to deliver truly optimized operation make them the best-in-class solution and the best match to effectively optimize production of today's oil wells.

## REFERENCES

1. Brown, K. E. (1982, October 1). Overview of Artificial Lift Systems. *Journal of Petroleum Technology* 34 (10): 2,384 - 2,396.
2. Rowlan, O. L., Lea, J. F., & McCoy, J. N. (2007, January 1). Overview of Beam Pump Operations. Paper SPE-110234 presented at the Society of Petroleum Engineers' Annual Technical Conference and Exhibition, Anaheim, California, 11-14 November.
3. Mehegan, L., Hernandez, J., & Phillips, W. (2013, May 21). Improving the Reliability and Maintenance Costs of Hydraulically Actuated Sucker Rod Pumping Systems. Paper SPE-165022 presented at Society of Petroleum Engineers' Artificial Lift Conference-Americas, Cartagena, Colombia, 21-22 May.
4. Zaleski, T.E. (1991 May). Sand-Control Alternatives for Horizontal Wells. *Journal of Petroleum Technology*.
5. Uren, L.C. (1925, December 1). Problems of Pumping Deep Wells. *Transactions of the AIME* G-25 (1) 130 - 156.
6. Bommer, P.M., & Shrauner, D. (2006, October 1). Benefits of Slow-Speed Pumping. *Journal of Petroleum Technology* 58 (10) 76-79.
7. Dunham, C.L. (1987 March). Supervisory Control of Beam Pumping Wells. *Society of Petroleum Engineers*.
8. Retzer K.D., Hill R.D., & Pratt S.G., Motor Vehicle Fatalities Among Oil and Gas Extraction Workers, *Accident Analysis and Prevention* 2013 51: 168-74.
9. Palka, K., & Czyz, J. (2009, May 1). Optimizing Downhole Fluid Production of Sucker-Rod Pumps with Variable Motor Speed. *Society of Petroleum Engineers' Production & Operations* 24 (2): 346-352.
10. Hein, N., Long, S., Mahoney, M. & Stevens, R. (2007, September) Sucker Rod Pumping Horizontal & Highly Deviated Wells – A Review & RPs. Houston, Texas (workshop).
11. Campbell, J.H., & Brimhall, R.M. (1989, January 1). An Engineering Approach to Gas Anchor Design. SPE-18826 presented at SPE Production Operations Symposium, Oklahoma City, Oklahoma, 13-14 March.
12. Cortines, J.M., & Hollabaugh, G.S. (1992, January 1). Sucker-Rod Lift in Horizontal Wells in Pearsall Field, Texas. Paper SPE-24764 presented at the SPE Annual Technical Conference and Exhibition, Washington, D.C., 4-7 October.
13. Parker, R.M. (1992 June). How to Prevent Gas-Locked Sucker Rod Pumps. *World Oil* June 1992: 47-50.

## APPENDIX

### Case 1A: Stuck Open Standing Valve — Remote Intervention after 24 hours

This well is in northern Oklahoma in the US. The pump is landed at 4,780 ft (1,457m). The initial symptom was a sudden increase in min polish rod load followed by a steady decline in peak polish rod load.

This is a classic sign of a stuck open standing valve where the traveling valve is not opening and fluid is slowly lost due to slippage.

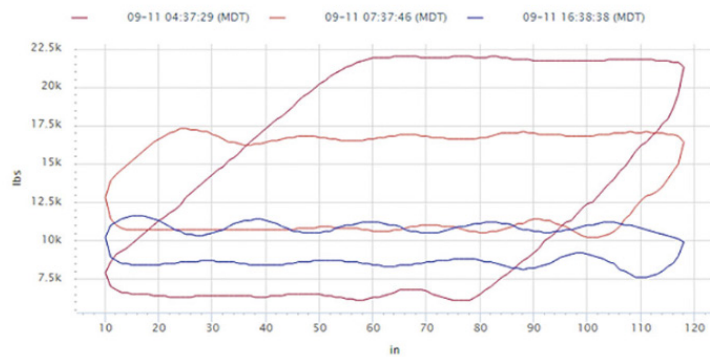
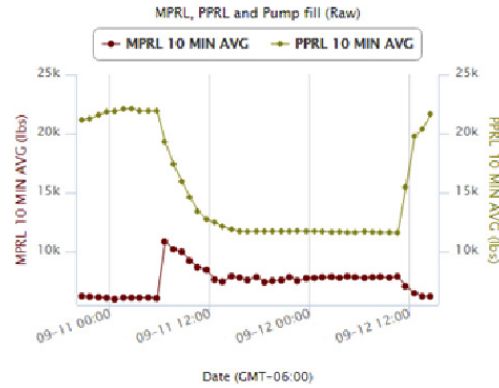

### Case 1B: Stuck Open Standing Valve – Remote Intervention after 2 hours

This well is in northern North Dakota in the US. The pump is landed at 3,150 ft (960m). Stuck open standing valve resulted in sudden increase in min polish rod load.

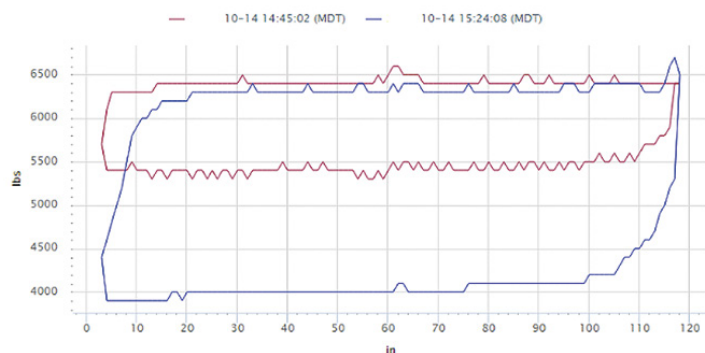
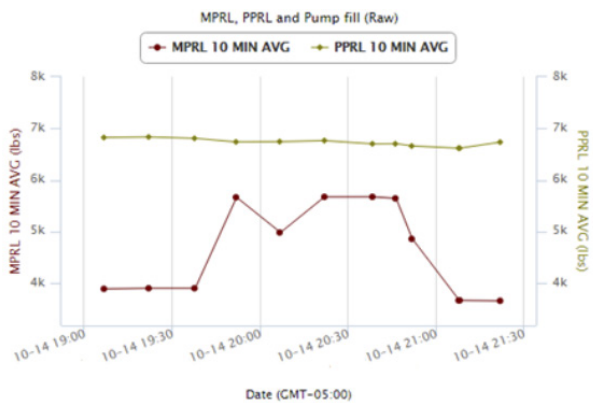

In both Cases 1A and 1B, resolution was a remote change in downstroke velocity (increased by about 1/3) for a period of about 30 minutes. Once cards returned to normal, the initial downstroke velocity was restored.

### Case 2: Stuck Open Travelling Valve — Remote Resolution

This well is in south eastern Alberta, Canada. The pump is landed at 2,560 ft (780m). The travelling valve was not seating on the upstroke at 3spm. The upstroke speed was increased and the valve had proper sealing again. Cards shown: regular operation, non-sealing valve, and back to regular operation.

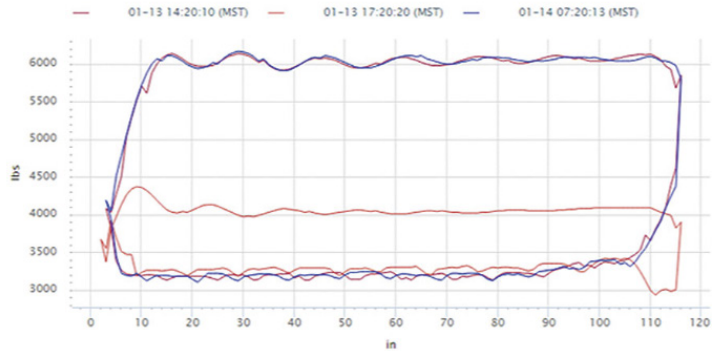

### Case 3: Sand Build-up in the Bottom of Pump – Remote Resolution

This well is in south eastern Alberta, Canada. The pump is landed at 2,723 ft (830m). Sand entered the pump and built up, the stroke was shortened and the pump speed increased. Then, stroke length and the rate restored. The standing valve and pump are now clear.

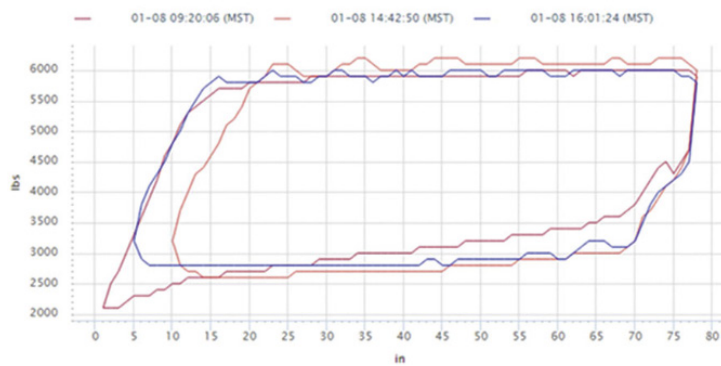

### Case 4: Sand Build Up at Top of Pump — Remote Resolution

This well is in south eastern Saskatchewan, Canada. The pump is landed at 4,026 ft (1,227m). Sand accumulated at the top of the pump and caused the plunger to have resistance at the top of the pump. The stroke length was lowered to stop compressing the sand. After a period of time, the sand produced up the tubing and the stroke length was restored.

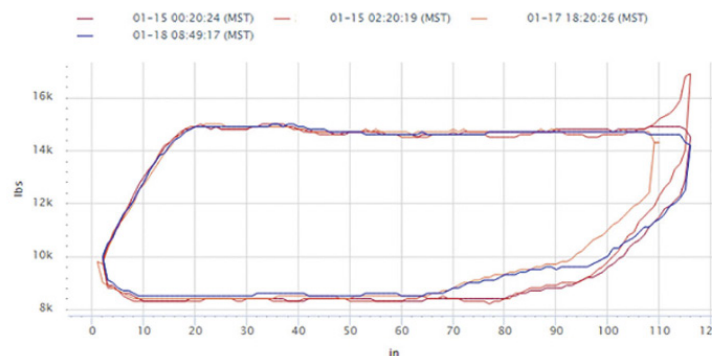
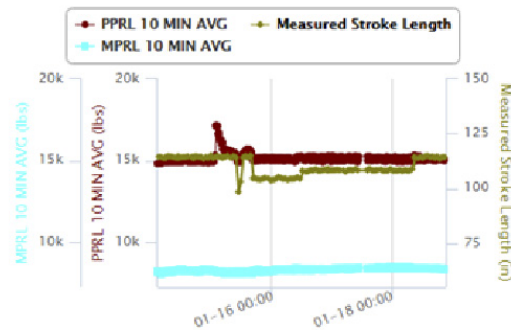



## Case 5: Gas Lock — Remote Resolution

This well is in southern Alberta, Canada. The pump is landed at ~3,740 ft (1,140m). In this example, gas lock was first observed around midnight (red line). After 15 hours of operation (orange line), the pump was still in a gas-locked state and field operations confirmed no production at the surface.

At that time, the downstroke velocity was increased by about one third. Within five minutes, regular downstroke rod weight resumed and, shortly after that, surface production was confirmed by field operations. This type of intervention on gas-locked wells is not always successful.

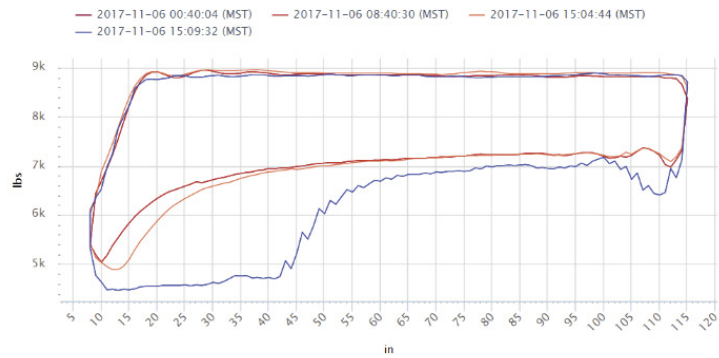

DeltaV™ SaaS SCADA is an IIoT cloud-native platform designed to enable asset-intensive industries to quickly and securely connect, acquire analytics and provide control of remotely located devices anywhere, anytime by anyone of your authorized users. We help our customers become more productive, profitable and sustainable to improve life around the globe.

SECURITY	SCALABILITY	SERVICE
<ul style="list-style-type: none"> <li>✓ Monthly automatic security updates</li> <li>✓ Secure web access anywhere, anytime</li> <li>✓ Two-factor authentication</li> <li>✓ Backups &amp; disaster recovery</li> <li>✓ ~3500 Microsoft™ security experts</li> </ul>	<ul style="list-style-type: none"> <li>✓ Mobile app anywhere, anytime access</li> <li>✓ Customer roadmap involvement</li> <li>✓ Customize your user groups</li> <li>✓ Budget friendly &amp; low CapEx</li> <li>✓ 26 effortless software updates in 2023</li> </ul>	<ul style="list-style-type: none"> <li>✓ Live 24/7/365 support included</li> <li>✓ eLearning courses &amp; workshops</li> <li>✓ Project Management available</li> <li>✓ Data Exchange service available</li> <li>✓ Alarm Management available</li> </ul>



### North America and Latin America Global Headquarters

Emerson Automation Solutions  
6005 Rogerdale Road  
Houston, TX, USA 77072  
T: +1 281 879 2699



### Europe

Emerson Automation Solutions  
Unit 1, Waterfront Business Park  
Dudley Road, Drierley Hill  
Dudley, UK DY5 1LX  
T: +44 1384 487200



### Middle East and Africa

Emerson Automation Solutions  
PO Box 17033  
Jebel Ali Free Zone - South 2  
Dubai, UAE  
T: +971 4 8118100



### Asia Pacific

Emerson Automation Solutions  
1 Panda Crescent  
Singapore 128461  
T: +65 6777 8211

© 2024 Emerson. All rights reserved.

The Emerson logo is a trademark and service mark of Emerson Electric Co. All other marks are the property of their respective owners. The contents of this publication are presented for information purposes only, and while every effort has been made to ensure their accuracy, they are not to be construed as warranties or guarantees, express or implied, regarding the products or services described herein or their use or applicability. All sales are governed by our terms and conditions, which are available on request. We reserve the right to modify or improve the design or specifications of our products at any time without notice. Responsibility for proper selection, use and maintenance of any product remains solely with the purchaser and end user.

### Find us in social media

Emerson | DeltaV Automation Platform

DeltaV SaaS SCADA