

Systembeschreibung | System description | Description du système
Descrizione del sistema | Descripción de sistema | Systembeskrivning

R412025062-BAL-001-AA
2023-06; Replaces: -
DE/EN/FR/IT/ES/SV

AVENTICS™ EtherCAT OMRON

Buskoppler AES/Ventiltreiber AV

Bus Coupler AES/Valve Driver AV

Coupleur de bus AES/Pilote de distributeurs AV

Accoppiatore bus AES/driver valvole AV

Acoplador de bus AES/controladores de válvula AV

Fältbusnod AES/Ventildrivenhet AV

EtherCAT 



EMERSON™

1 Zu dieser Dokumentation

1.1 Gültigkeit der Dokumentation

Diese Dokumentation gilt für die Buskoppler der Serie AES für EtherCAT, welche an eine OMRON-SPS angeschlossen werden. Diese Dokumentation richtet sich an Programmierer und Elektroplaner.

1.2 Erforderliche und ergänzende Dokumentation

Dokumentation	Dokumentart / Materialnummer	Bemerkung
Systembeschreibung des AES-Buskopplers für EtherCAT	Systembeschreibung / R412018142	PDF-Datei auf CD Online im Emerson Store

2 Netzwerk konfigurieren

1. AES-EtherCAT-Busmodul konfigurieren, welches an den OMRON-plc angeschlossen ist.
2. Folgende Konfigurationsdateien aus dem Verzeichnis "..\OMRON\Systemac Studio\IODeviceProfiles\EsiFiles\UserEsiFiles\" löschen, falls diese vorhanden sind: "AES_EcatKoppler.xml" und "AES_Slot.xml", „AES2_EcatKoppler.xml“ und “AES2_Slot.xml”.
3. Folgende neue Konfigurationsdateien im Verzeichnis speichern und Sysmac Studio starten:
 "AES_EcatKoppler_om.xml"
 "AES2_EcatKoppler_om.xml"
 "AES_Slot_om.xml"
 "AES2_Slot_om.xml"

2.1 Netzwerkkonfigurationen vergleichen und zusammenführen

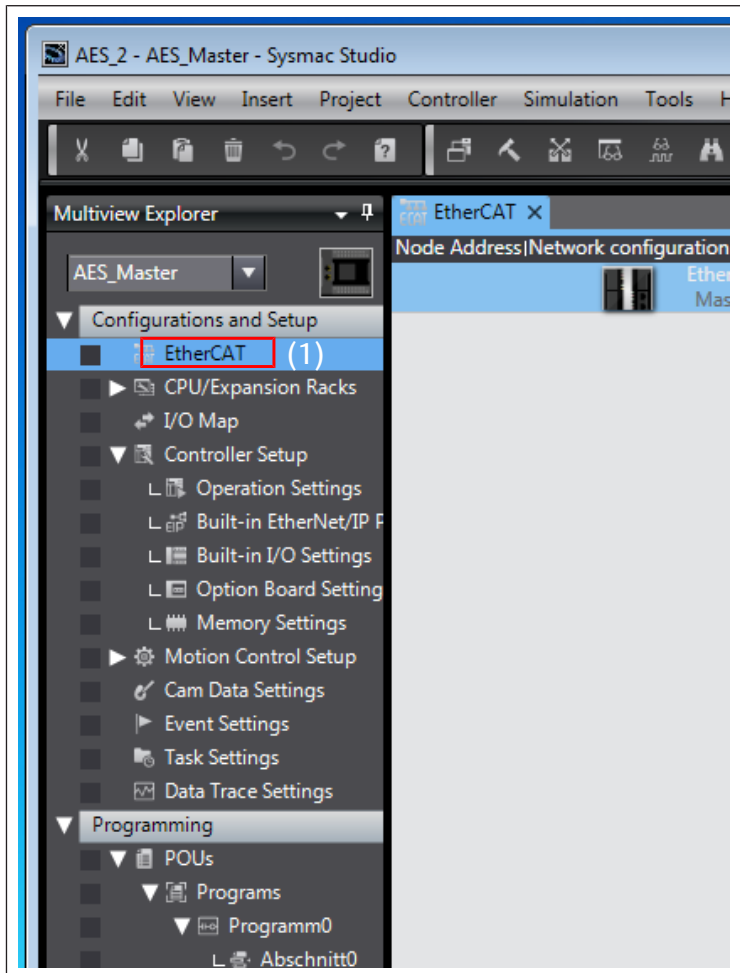

1. Doppelter Mausklick auf EtherCAT (1).
2. Verbindung zur SPS aufbauen (**Online** gehen).

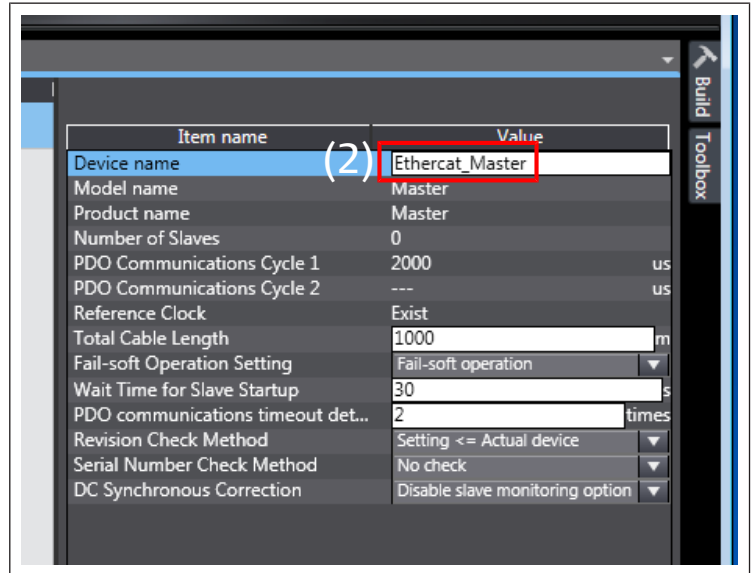

3. Rechter Mausklick auf *Ethercat_Master* (2) und im Auswahlnenü *Compare and Merge with Actual Network Configuration* wählen.

Knotenadresse ändern



Abb. 1: Fehler bei der Knotenadresse

Erscheint die Fehlermeldung *Failed to get Production information*, muss die Knotenadresse der angeschlossenen Geräte in den zulässigen Bereich (1 ... 192) geändert werden.

EtherCAT-Adresse vergeben

⚠ VORSICHT

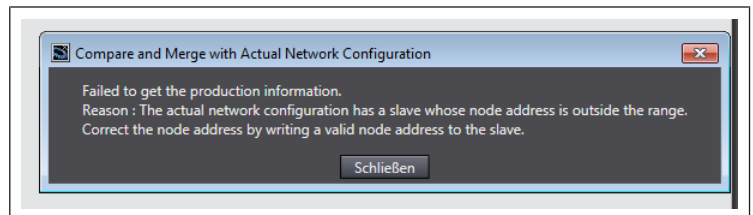
Verletzungsgefahr durch Änderungen der Einstellungen im laufenden Betrieb

Unkontrollierten Bewegungen der Aktoren sind möglich!

► Einstellungen niemals im laufenden Betrieb ändern.

Der Buskoppler benötigt im EtherCAT-Netzwerk eine eindeutige Adresse, um von der Steuerung erkannt zu werden.



Abb. 2: Adressschalter S1 und S2 am Buskoppler

Tab. 1: Adressierungsbeispiele

Schalterposition S1	Schalterposition S2	Stationsadresse
High-Nibble (hexadezimale Beschriftung)	Low-Nibble hexadezimale Beschriftung)	
0	1	1
0	2	2
...
0	F	15
1	0	16
1	1	17
...
9	F	159
A	0	160
...
C	0	192

3 Aktuelle Netzwerkkonfiguration übernehmen

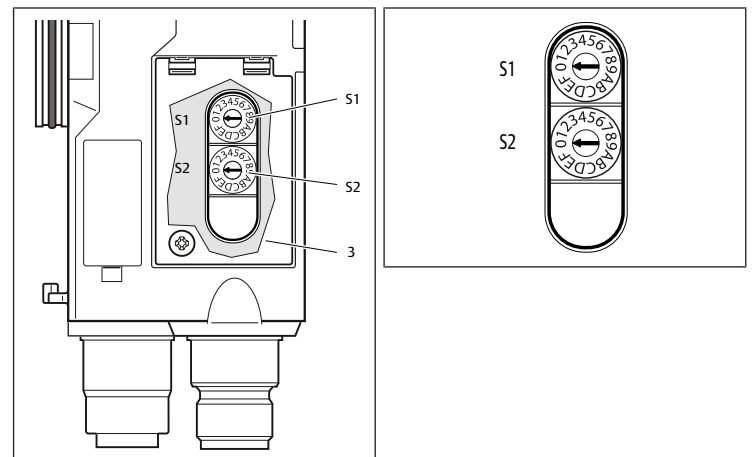
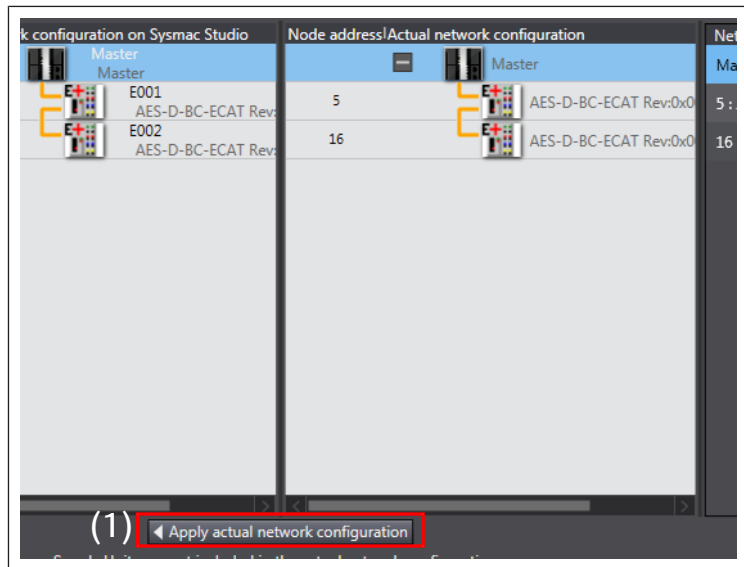

1. Klick auf **Apply actual network configuration** (1).
2. Klick auf **Apply** und danach auf **confirm**.



Abb. 3: Netzwerkkonfiguration

3. Überprüfen, ob in beiden Spalten **Comparison result** (2) und **Lower configuration** (3) die Bezeichnung **Matched** erscheint.

Aktuelle Netzwerkübernahme fehlgeschlagen

Fehler **Aquisition failed** wird angezeigt:

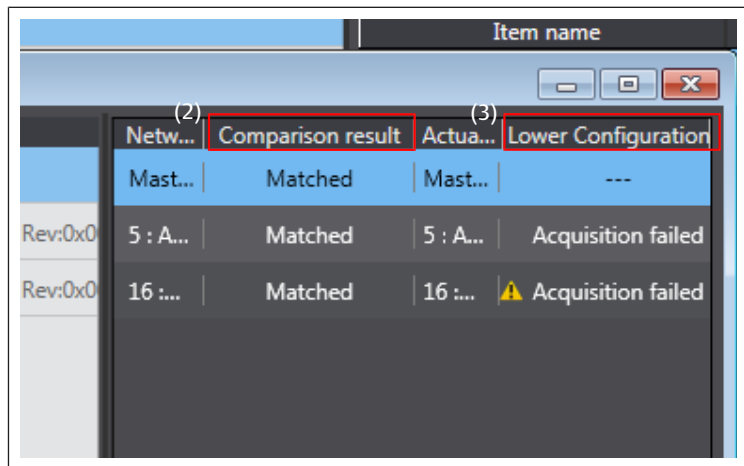
1. Löschen der Geräte in Sysmac Studio.
2. Klick auf **Apply actual network configuration** (1).

Aktuelle Netzwerkübernahme angepasst



Abb. 4: Konfiguration angepasst

Die Netzwerkübernahme war erfolgreich, wenn in beiden Spalten die Bezeichnung „Matched“ erscheint.

- Konfiguration an SPS senden.

4 Module konfigurieren

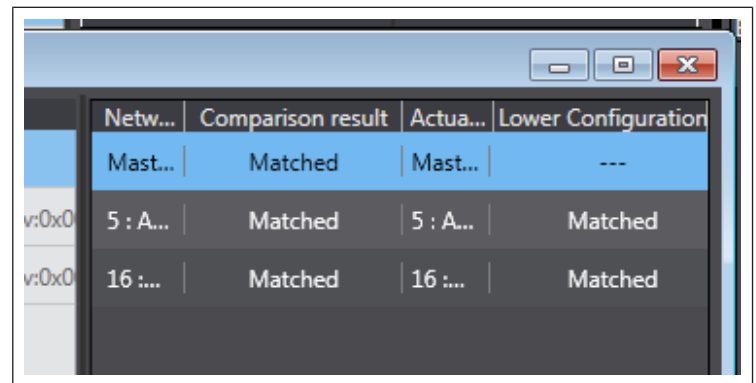
Ventile müssen manuell der Konfiguration hinzugefügt werden, bevor der Scan gestartet wird. Die restliche Konfiguration kann nun automatisch erkannt werden.



Abb. 5: Modulkonfiguration bearbeiten



Abb. 6: Modulkonfiguration übernehmen

1. Klick auf **Edit Module Configuration** für jedes AES-Modul.
2. Rechter Mausklick auf **0 Terminal**.
3. Im Auswahlménú **Compare and Merge with Actual Module Configuration** wählen und mit **confirm** bestätigen.
4. Verbindung zur SPS aufbauen (**Online** gehen).

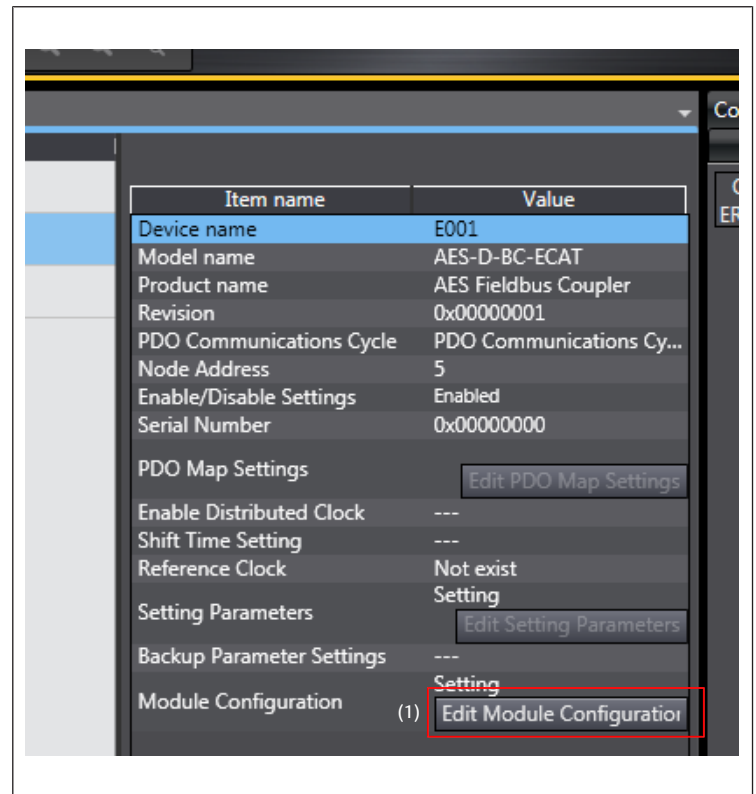
Modulsendemethode ändern

Standardmäßig ist „Do not send“ eingestellt.

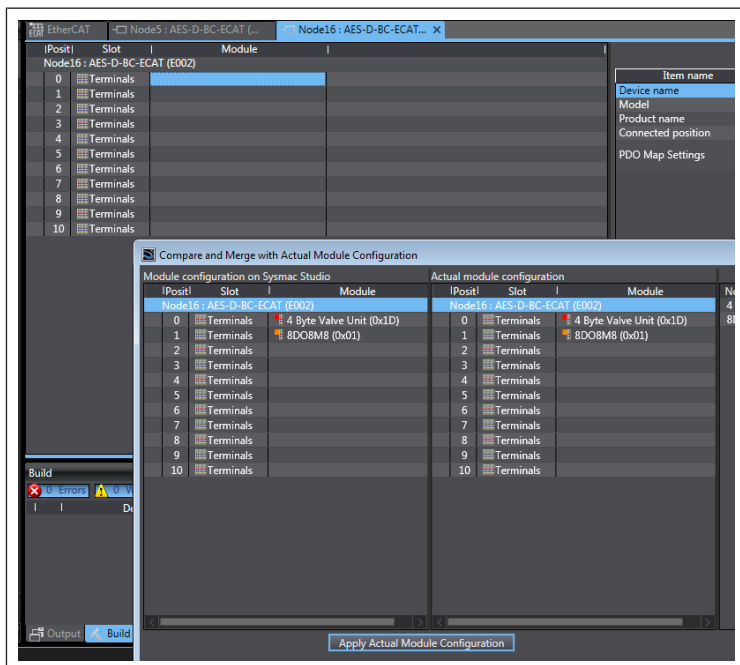

Abb. 7: Einstellung der Sendemethode

1. Klick auf **Edit Module Configuration** für jedes AES-Modul.
2. In Zeile **Module config send method** (1) **Send** auswählen.
3. Verbindung zur SPS aufbauen (**Online** gehen).
4. Konfiguration an SPS senden.

5 Parameter setzen

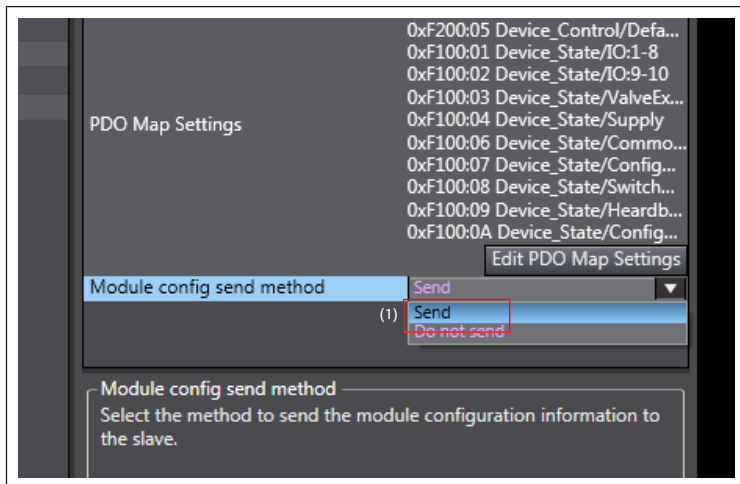
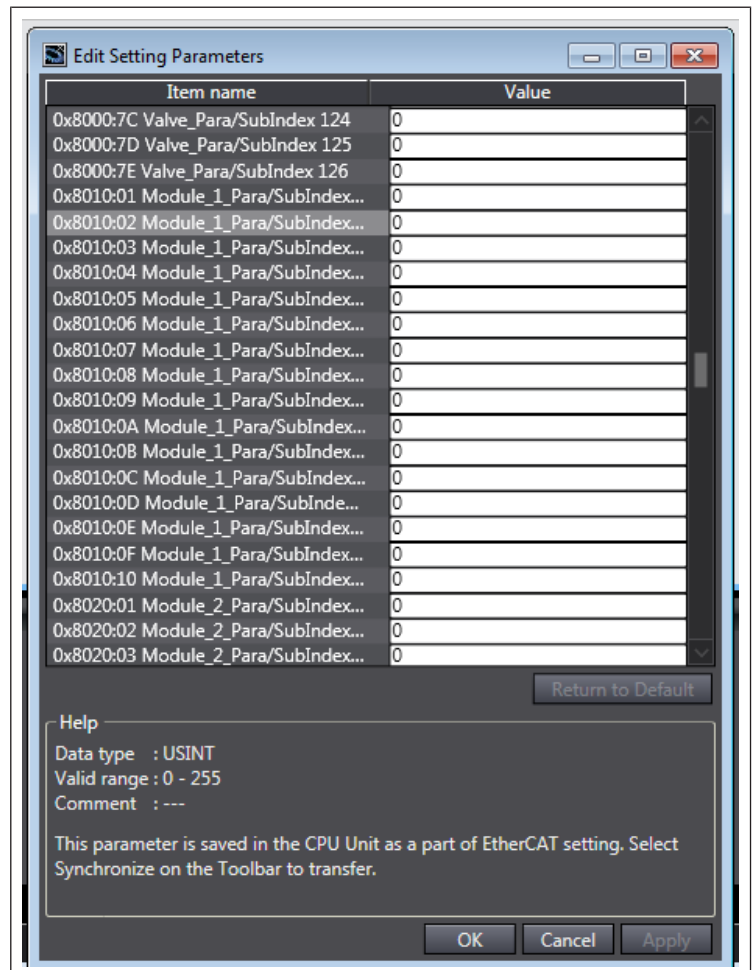
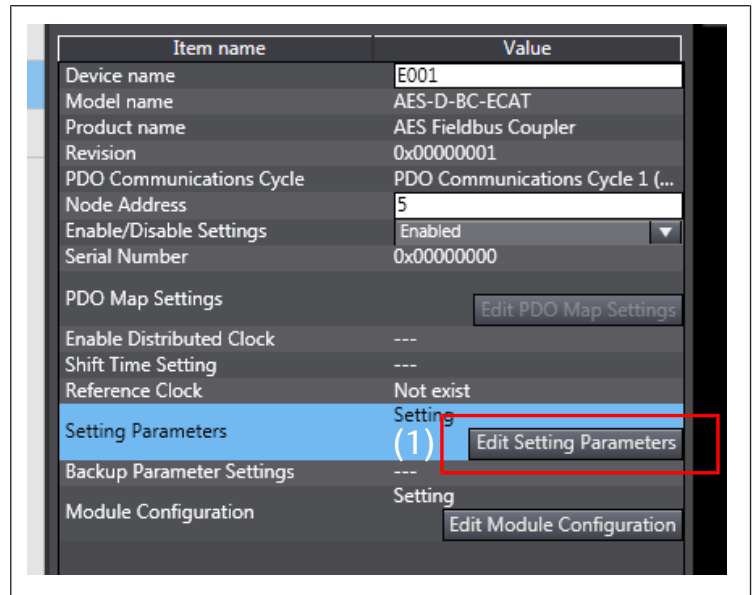

1. Verbindung zur SPS beenden (**Offline** gehen).
2. Klick auf **Edit Setting Parameters** (1) für jedes AES-Modul, um die Standardparameter zu ändern.

Die maximale Anzahl an Parametern wird angezeigt.
126 Bytes Ventilparameter und 10x16 IO-Modulparameter.

INFO: Es werden nur die Parameter übertragen, die von den AES-Modulen verwendet werden.

3. Verbindung zur SPS aufbauen (**Online** gehen).

1 About this documentation

1.1 Documentation validity

This documentation is valid for the AES series bus couplers for EtherCAT, which are connected to an OMRON PLC. This documentation is geared toward programmers and electrical engineers.

1.2 Required and supplementary documentation

Documentation	Document type / material number	Remark
System description of the AES bus coupler for EtherCAT	System description / R412018142	PDF file on CD Online in the Emerson store

2 Configuring the network

1. Configure the AES EtherCAT bus module connected to the OMRON PLC.
2. Delete the following configuration files from the directory “..\OMRON\Systemac Studio\IODeviceProfiles\EsiFiles\UserEsiFiles” if they exist: “AES_EcatKoppler.xml” and “AES_Slot.xml”, „AES2_EcatKoppler.xml” and “AES2_Slot.xml”.
3. Save the following new configuration files in the directory and start Sysmac Studio:
 “AES_EcatKoppler_om.xml”
 “AES2_EcatKoppler_om.xml”
 “AES_Slot_om.xml”
 “AES2_Slot_om.xml”

2.1 Comparing and merging network configurations

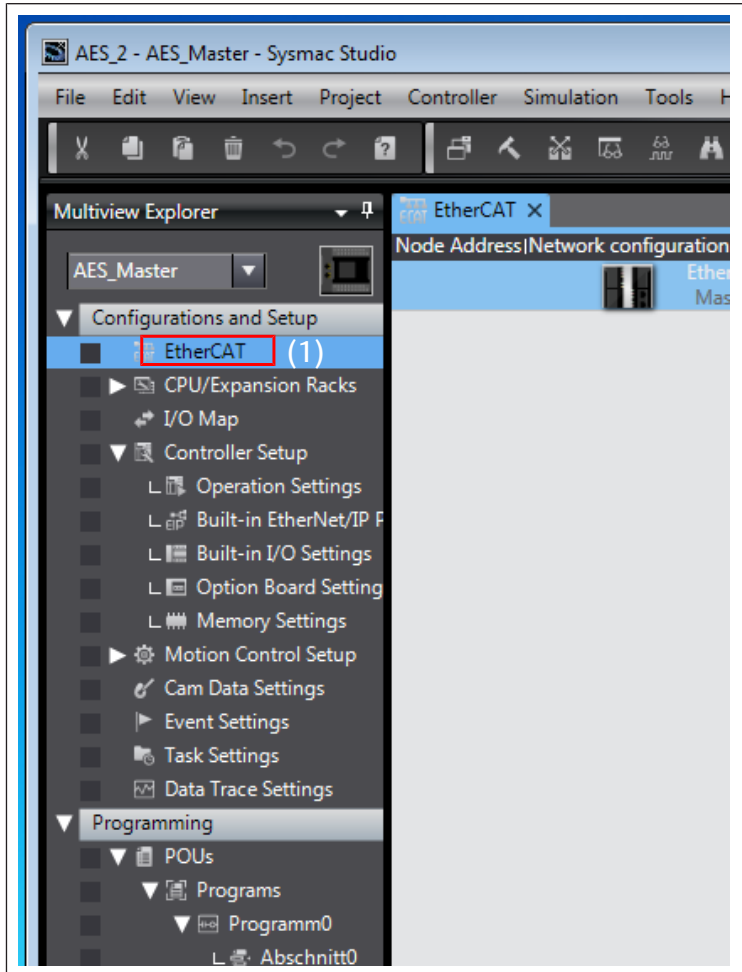

1. Double click on EtherCAT (1).
2. Establish a connection to the PLC (go *online*).

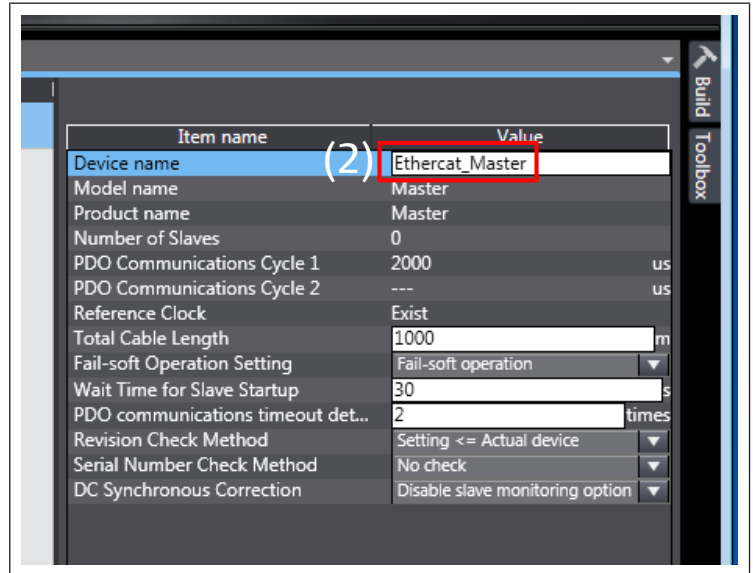

3. Right click on *Ethercat_Master* (2) and select *Compare and Merge with Actual Network Configuration* in the selection menu.

Changing the node address

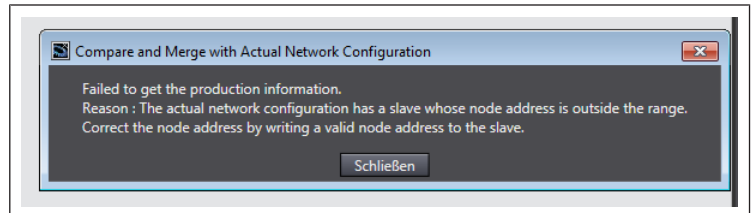

Fig. 1: Node address error

If the error message *Failed to get Production information* appears, the node address of the connected devices must be changed to the permissible range (1 ... 192).

Assigning an EtherCAT address

⚠ CAUTION

Danger of injury if changes are made to the settings during operation.
 Uncontrolled movement of the actuators is possible!

► Never change the settings during operation.

The bus coupler requires a unique address in the EtherCAT network in order to be detected by the controller.

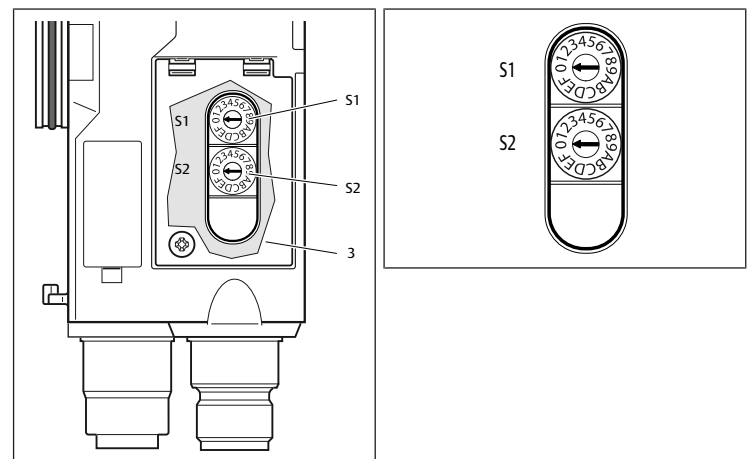

Fig. 2: Address switches S1 and S2 on the bus coupler

Table 1: Addressing examples

S1 switch position (hexadecimal label)	S2 switch position (hexadecimal label)	Station address
High nibble	Low nibble	
0	1	1
0	2	2

S1 switch position	S2 switch position	Station address
High nibble (hexadecimal label)	Low nibble (hexadecimal label)	
...
0	F	15
1	0	16
1	1	17
...
9	F	159
A	0	160
...
C	0	192

Current network acquisition adapted

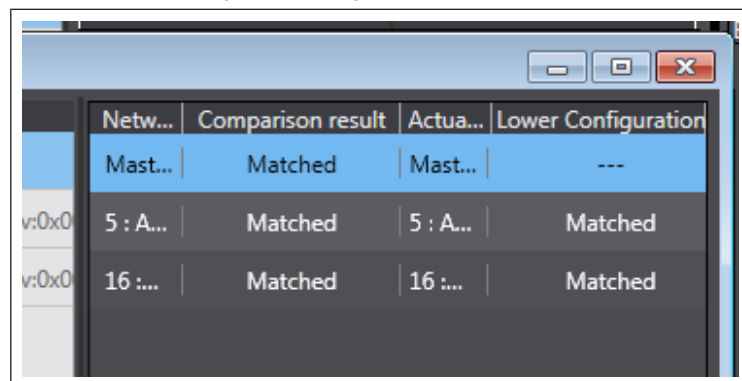
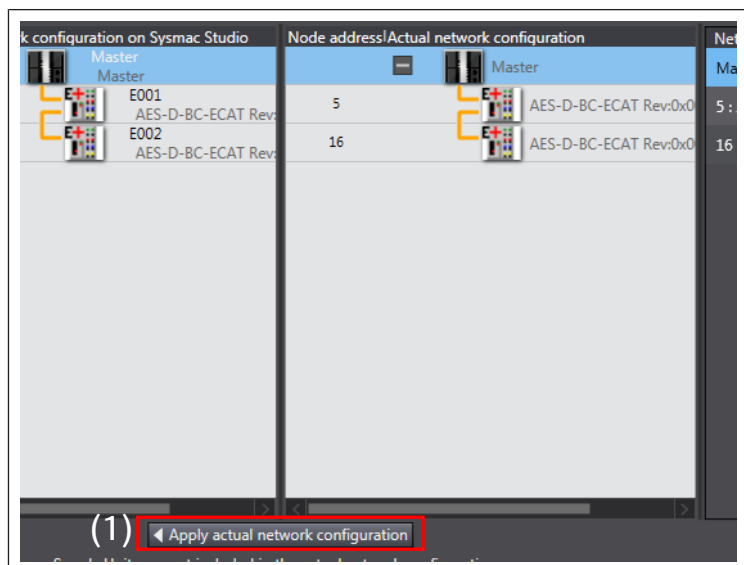

Fig. 4: Configuration adapted

The network acquisition was successful if the designation "Matched" appears in both columns.

- Send the configuration to the PLC.

3 Applying the current network configuration



1. Click on *Apply actual network configuration* (1).
2. Click on *Apply* and then on *confirm*.

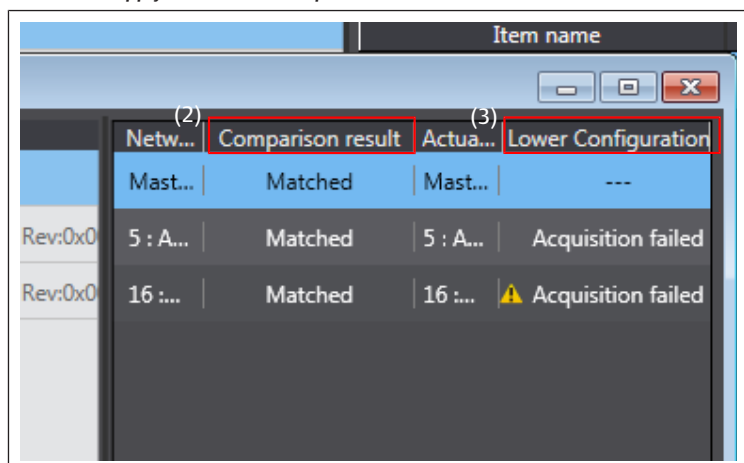

Fig. 3: Network configuration

3. Check whether the designation *Matched* appears in both columns *Comparison result* (2) and *Lower configuration* (3).

Current network acquisition failed

The error *Aquisition failed* is displayed:

1. Delete the devices in Sysmac Studio.
2. Click on *Apply actual network configuration* (1).

4 Configuring modules

Valves must be added manually to the configuration before the scan is started. The rest of the configuration can now be detected automatically.

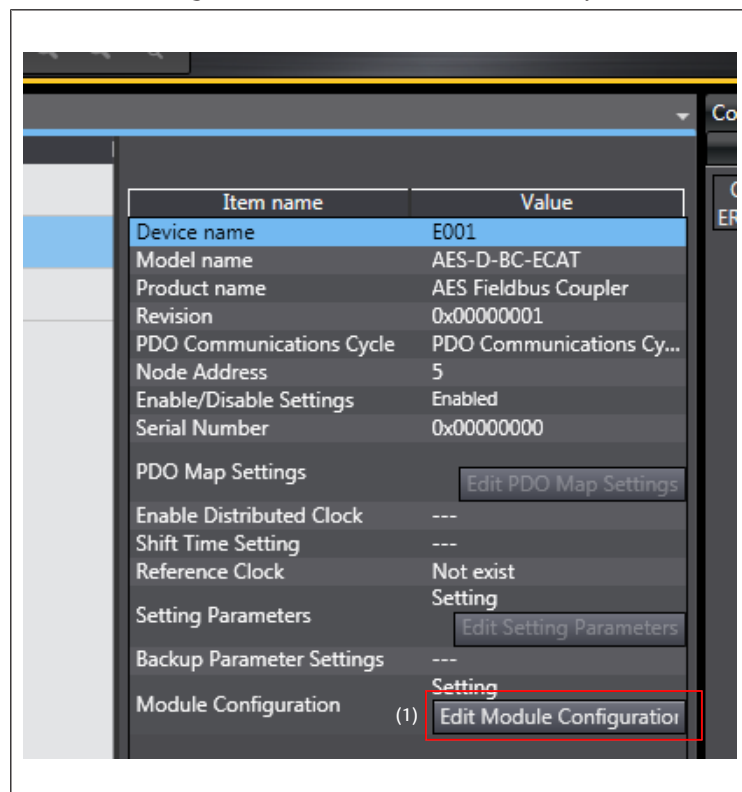

Fig. 5: Editing the module configuration

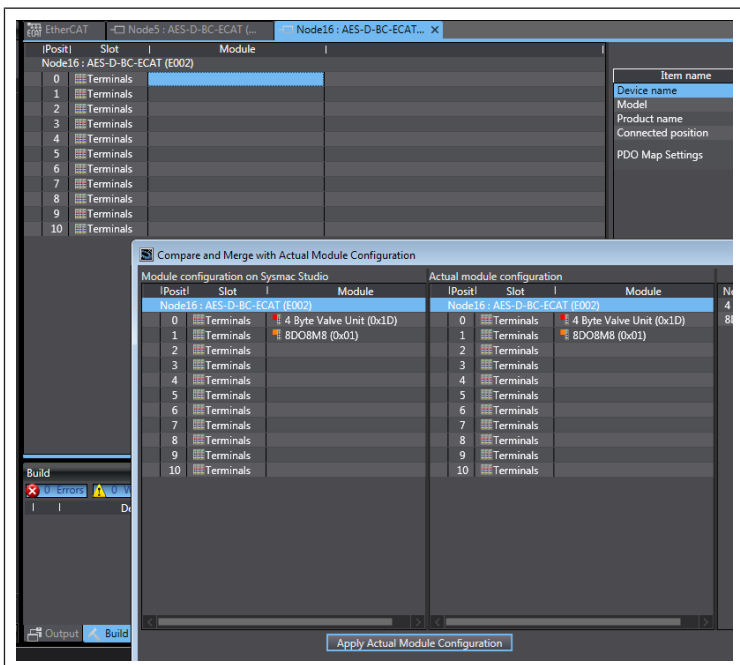

Fig. 6: Applying the module configuration

1. Click on **Edit Module Configuration** for each AES module.
2. Right click on **0 Terminal**.
3. In the selection menu select **Compare and Merge with Actual Module Configuration** and confirm with **confirm**.
4. Establish a connection to the PLC (go **online**).

Changing the module send method

By default, "Do not send" is set.

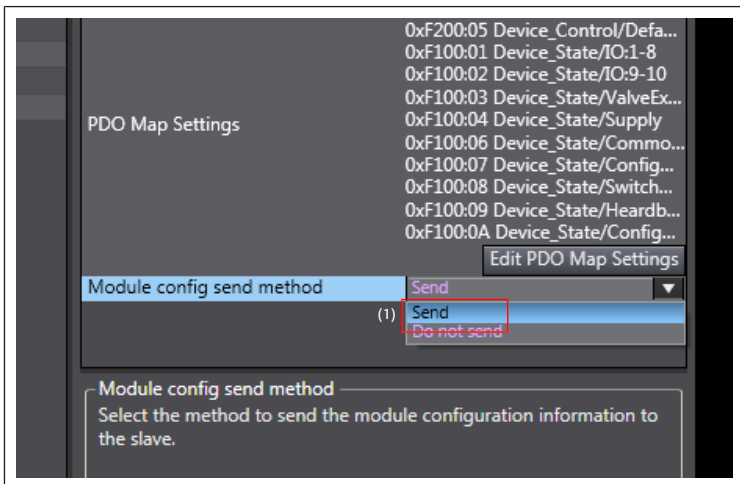
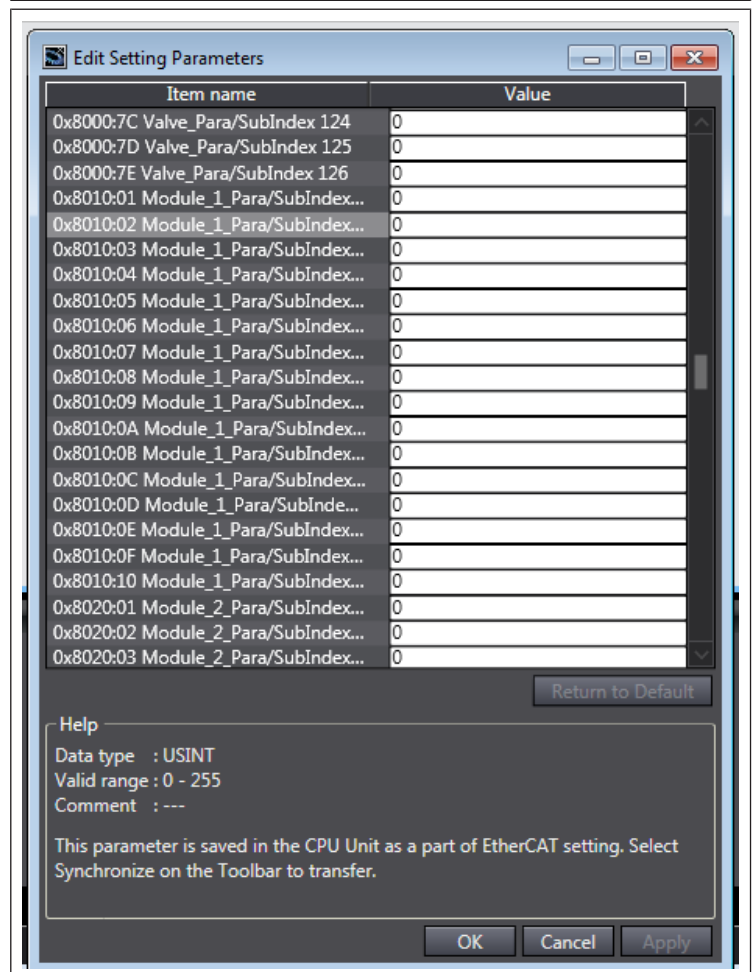
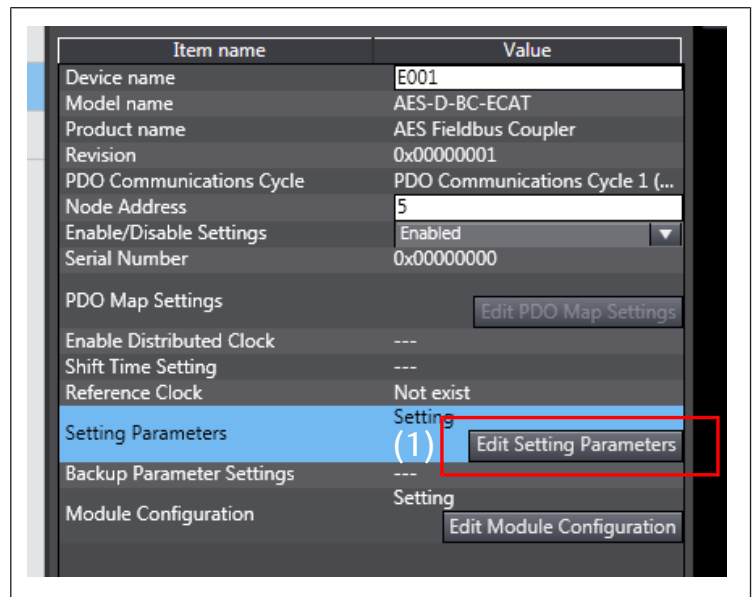

Fig. 7: Setting the send method

1. Click on **Edit Module Configuration** for each AES module.
2. In the line **Module config send method** (1) select **Send**.
3. Establish a connection to the PLC (go **online**).
4. Send the configuration to the PLC.

5 Setting parameters



1. Terminate the connection to the PLC (go **offline**).
2. Click on **Edit Setting Parameters** (1) for each AES module to change the default parameters.

The maximum number of parameters is displayed.
126 bytes valve parameters and 10x16 IO module parameters.

INFO: Only the parameters used by the AES modules are transmitted.

3. Establish a connection to the PLC (go **online**).

1 À propos de cette documentation

1.1 Validité de la documentation

Cette documentation s'applique au coupleur de bus de la série AES pour EtherCAT, qui est raccordé à une API OMRON. Cette documentation s'adresse aux programmeurs et aux planificateurs-électriciens.

1.2 Documentation nécessaire et complémentaire

Documentation	Type de document/Référence	Remarque
Description du système du coupleur de bus AES pour EtherCAT	Description du système/ R412018142	Fichier PDF sur CD En ligne dans l'Emerson Store

2 Configuration du réseau

1. Configurer le module bus AES EtherCAT qui est raccordé à l'API OMRON.
2. Le cas échéant, supprimer les fichiers de configuration suivants du répertoire « ..\OMRON\Systemac Studio\IODeviceProfiles\EsiFiles\UserEsiFiles » : « AES_EcatKoppler.xml » et « AES_Slot.xml », « AES2_EcatKoppler.xml » et « AES2_Slot.xml ».
3. Enregistrer les nouveaux fichiers de configuration suivants dans le répertoire et démarrer Sysmac Studio : « AES_EcatKoppler_om.xml » « AES2_EcatKoppler_om.xml » « AES_Slot_om.xml » « AES2_Slot_om.xml »

2.1 Comparaison et fusion des configurations réseau

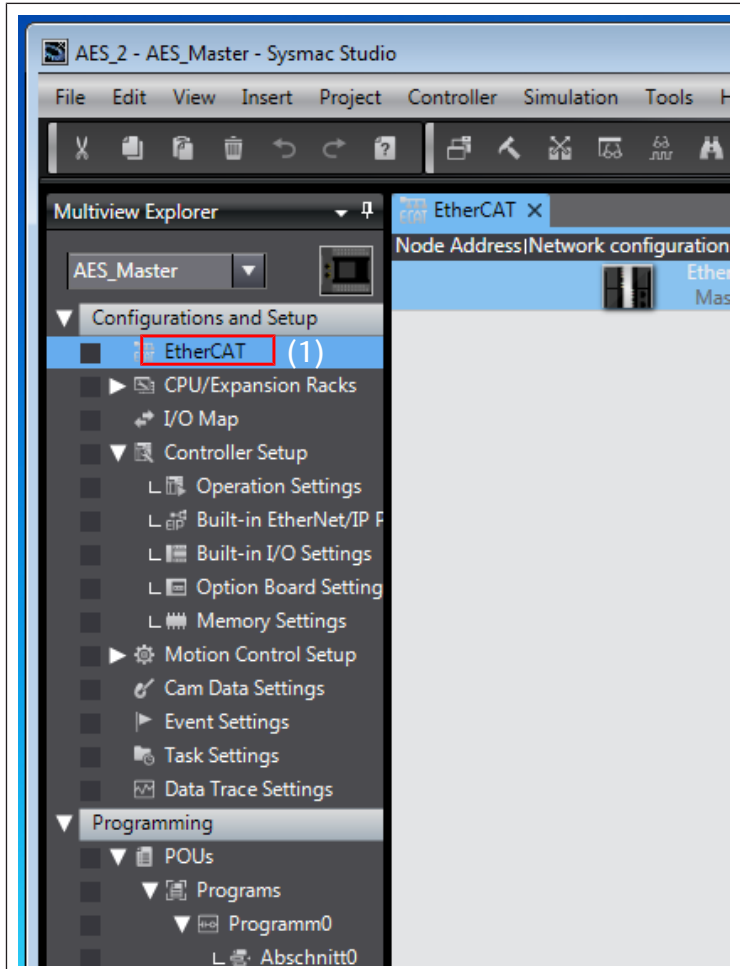

1. Double-cliquer sur EtherCAT (1).
2. Établir la connexion avec l'API (sélectionner *En ligne*).

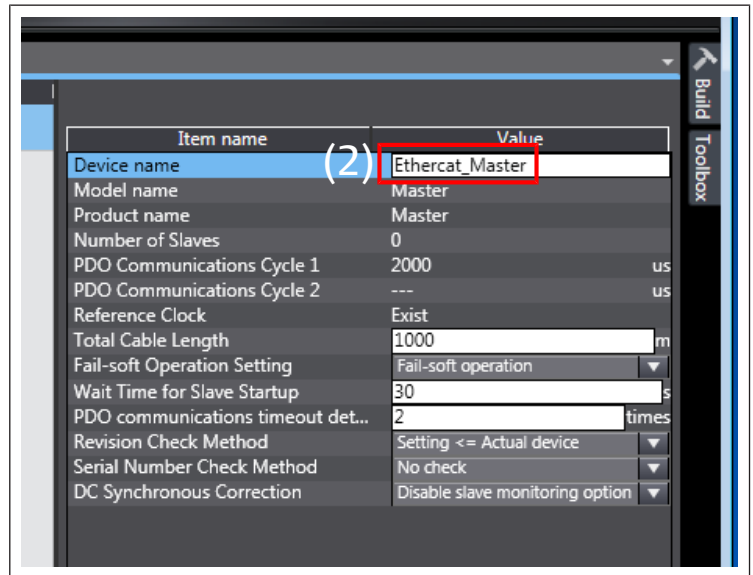

3. Faire un clic droit sur *Ethercat_Master* (2) et sélectionner *Compare and Merge with Actual Network Configuration* dans le menu de sélection.

Modification de l'adresse de nœud

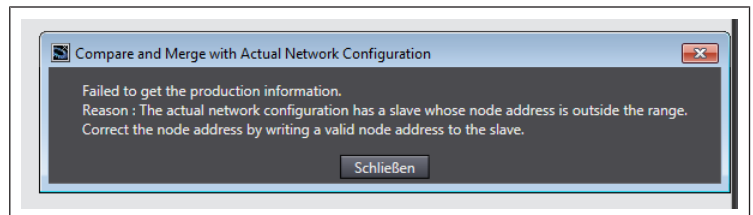

Fig. 1: Erreur relative à l'adresse de nœud

Si le message d'erreur *Failed to get Production information* apparaît, l'adresse de nœud des appareils raccordés doit être modifiée dans la plage autorisée (1 ... 192).

Attribution d'une adresse EtherCAT

⚠ ATTENTION

Risque de blessure dû à une modification des réglages en cours de fonctionnement

Des mouvements incontrôlés des actionneurs sont possibles !

► Ne jamais modifier les réglages en cours de fonctionnement.

Dans le réseau EtherCAT, le coupleur de bus nécessite une adresse univoque afin d'être détecté par la commande.

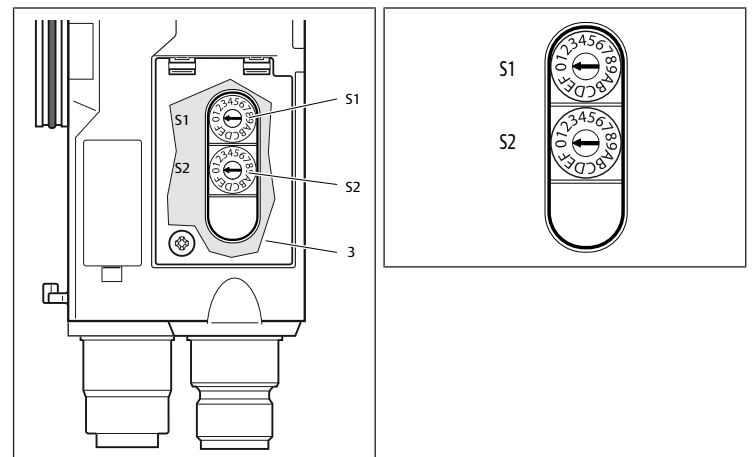
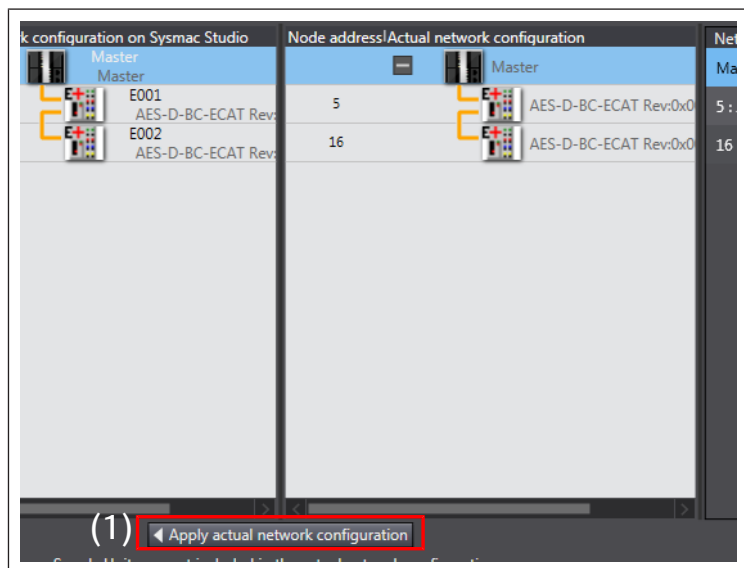

Fig. 2: Commutateurs d'adresse S1 et S2 du coupleur de bus

Tab. 1: Exemples d'adressage

Position du commutateur S1	Position du commutateur S2	Adresse de la station
Nibble supérieur	Nibble inférieur	
(numérotation hexadécimale)	(numérotation hexadécimale)	
0	1	1
0	2	2
...
0	F	15
1	0	16
1	1	17
...
9	F	159
A	0	160
...
C	0	192

3 Application de la configuration réseau actuelle



1. Cliquer sur *Apply actual network configuration* (1).
2. Cliquer sur *Apply* puis sur *confirm*.

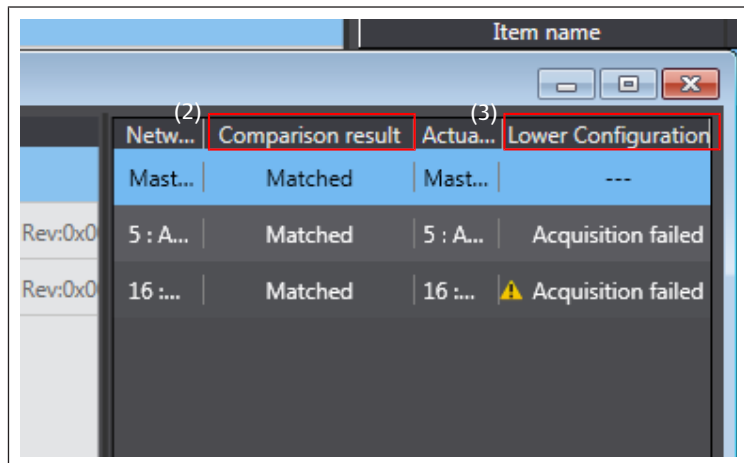

Fig. 3: Configuration réseau

3. Dans les deux colonnes *Comparison result* (2) et *Lower configuration* (3), vérifier que la désignation *Matched* apparaît.

Échec de l'application du réseau actuel

L'erreur *Aquisition failed* s'affiche :

1. Suppression des appareils dans Sysmac Studio.
2. Cliquer sur *Apply actual network configuration* (1).

Adaptation de l'application du réseau actuel

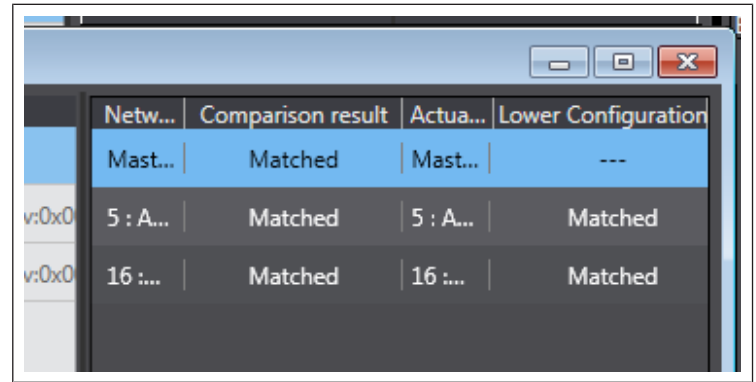

Fig. 4: Configuration adaptée

L'application du réseau est réussie si la désignation « Matched » apparaît dans les deux colonnes.

- Envoyer la configuration à l'API.

4 Configuration des modules

Les distributeurs doivent être ajoutés manuellement à la configuration avant de démarrer le scan. Le reste de la configuration peut alors être détecté automatiquement.

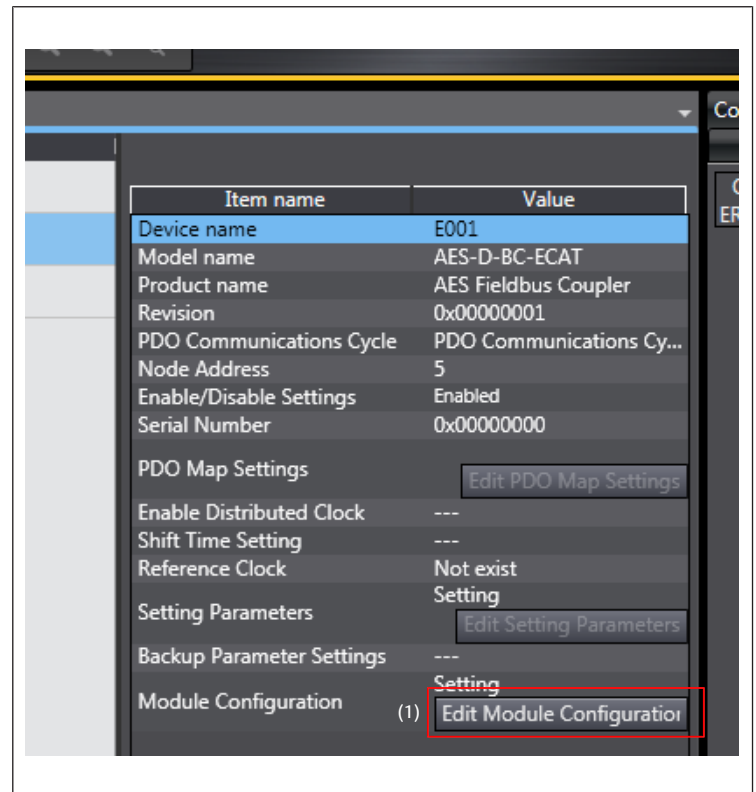

Fig. 5: Modification de la configuration des modules

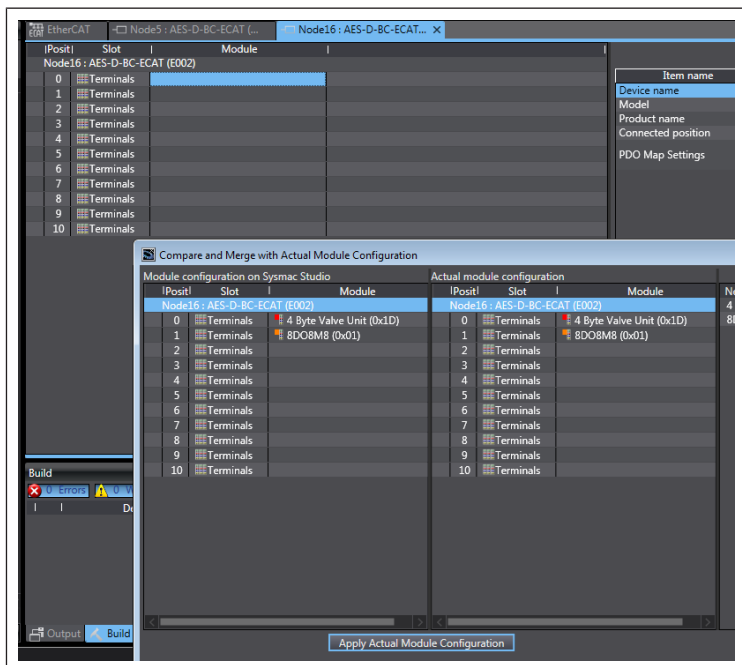

Fig. 6: Application de la configuration des modules

1. Cliquer sur **Edit Module Configuration** pour chaque module AES.
2. Faire un clic droit sur **0 Terminal**.
3. Dans le menu de sélection, sélectionner **Compare and Merge with Actual Module Configuration** et confirmer avec **confirm**.
4. Établir la connexion avec l'API (sélectionner **En ligne**).

Modification de la méthode d'envoi des modules

« Do not send » est le réglage par défaut.

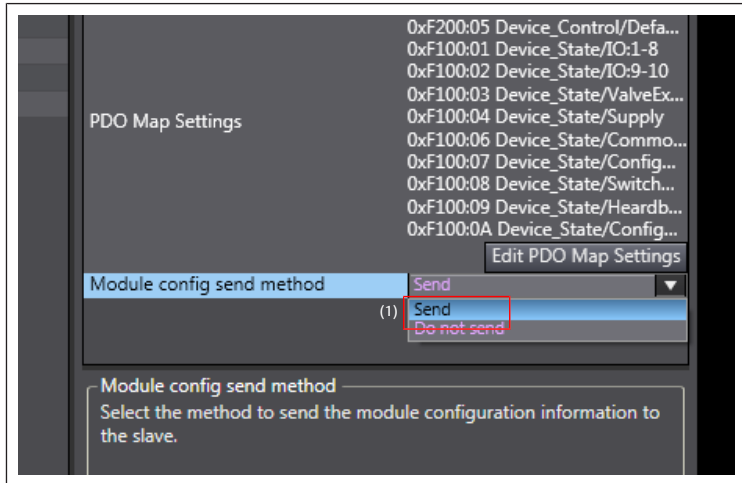
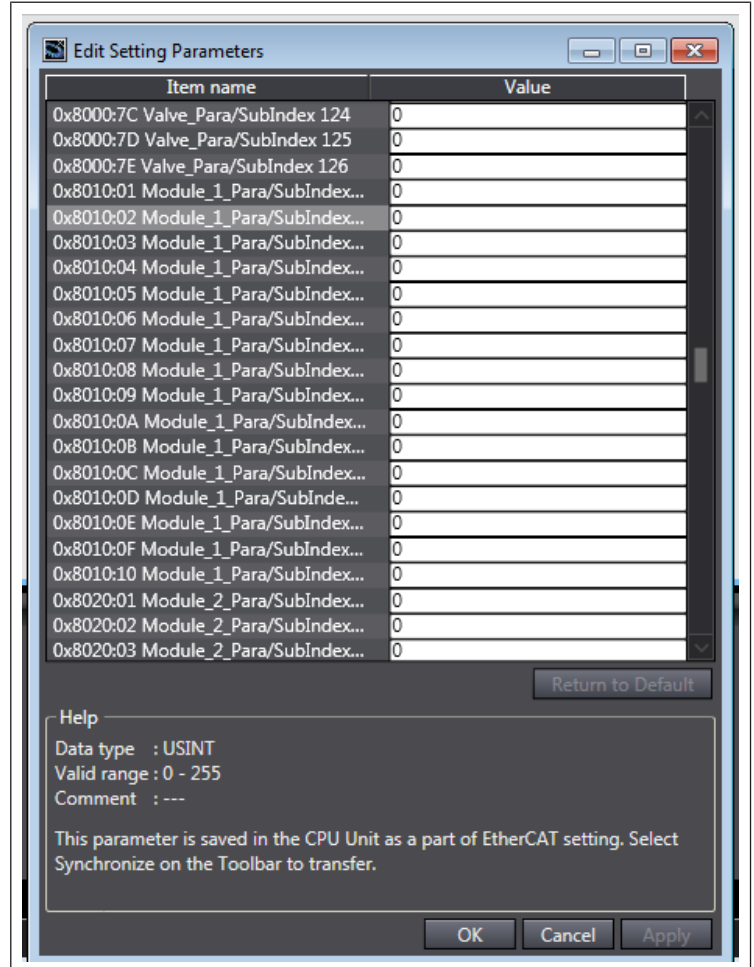
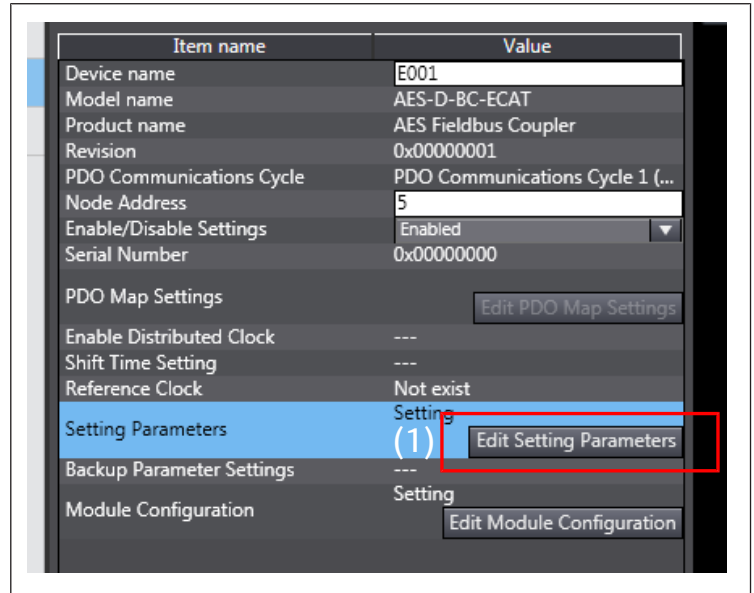

Fig. 7: Réglage de la méthode d'envoi

1. Cliquer sur **Edit Module Configuration** pour chaque module AES.
2. Dans la ligne **Module config send method** (1), sélectionner **Send**.
3. Établir la connexion avec l'API (sélectionner **En ligne**).
4. Envoyer la configuration à l'API.

5 Définition des paramètres



1. Terminer la connexion avec l'API (sélectionner **Hors ligne**).
2. Cliquer sur **Edit Setting Parameters** (1) pour chaque module AES pour modifier les paramètres standard.

Le nombre maximal de paramètres s'affiche.

126 octets de paramètres de distributeurs et 10x16 paramètres de modules E/S.

INFO: Seuls les paramètres utilisés par les modules AES sont transmis.

3. Établir la connexion avec l'API (sélectionner **En ligne**).

1 Sulla presente documentazione

1.1 Validità della documentazione

Questa documentazione è valida per l'accoppiatore bus della serie AES per EtherCAT collegato a un PLC OMRON. Questa documentazione è indirizzata a programmatori e a progettisti elettrotecnici.

1.2 Documentazione necessaria e complementare

Documentazione	Tipo di documento / codice	Osservazione
Descrizione dell'accoppiatore bus AES per EtherCAT	Descrizione del sistema / R412018142	File PDF su CD Online nell'Emerson Store

2 Configurare la rete

1. Configurare il modulo bus AES-EtherCAT collegato al PLC OMRON.
2. Cancellare i seguenti dati di configurazione dalla directory "..\OMRON\Systemac Studio\IODeviceProfiles\EsiFiles\UserEsiFiles", nel caso siano presenti: "AES_EcatKoppler.xml" e "AES_Slot.xml", "AES2_EcatKoppler.xml" e "AES2_Slot.xml".
3. Salvare i nuovi dati di configurazione seguenti nella directory e avviare Sysmac Studio:
 "AES_EcatKoppler_om.xml"
 "AES2_EcatKoppler_om.xml"
 "AES_Slot_om.xml"
 "AES2_Slot_om.xml"

2.1 Confrontare e unire le configurazioni di rete

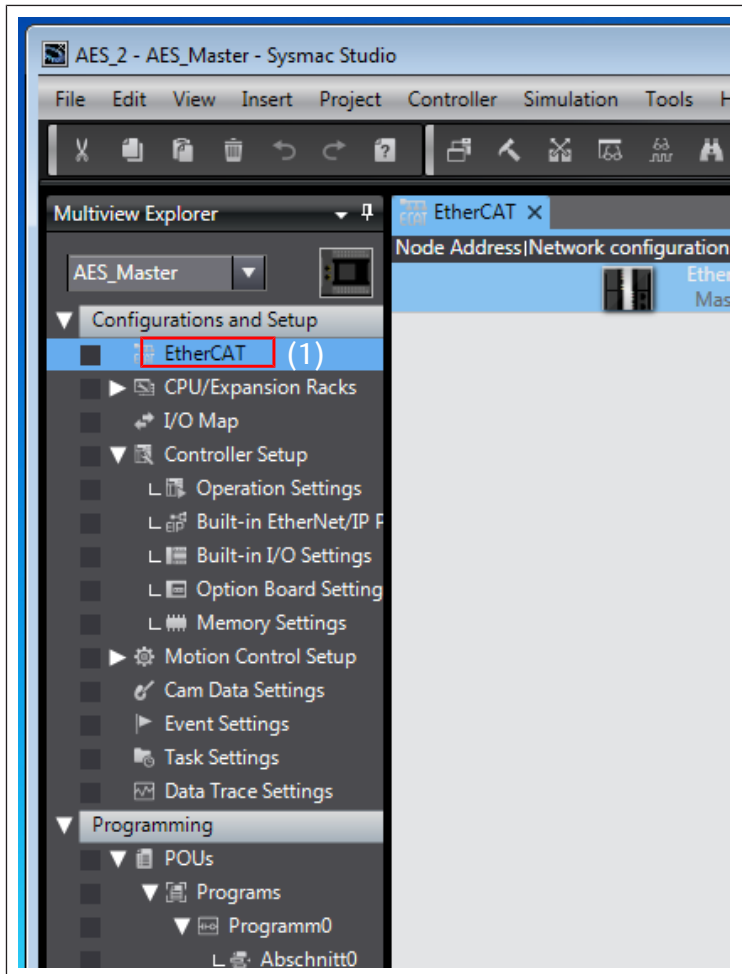

1. Doppio clic del mouse su EtherCAT (1).
2. Creare una connessione al PLC (andare **online**).

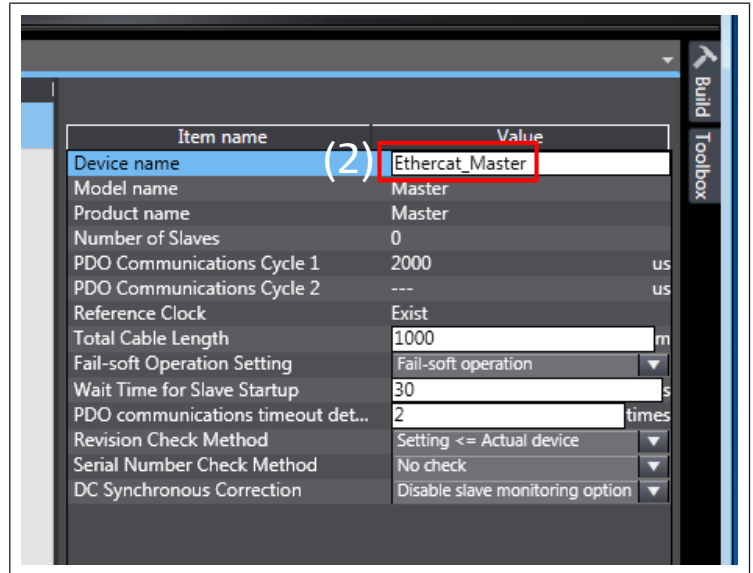

3. Cliccare con il tasto destro del mouse su *Ethercat_Master* (2) e selezionare nel menu a discesa *Compare and Merge with Actual Network Configuration*.

Modificare l'indirizzo di nodo

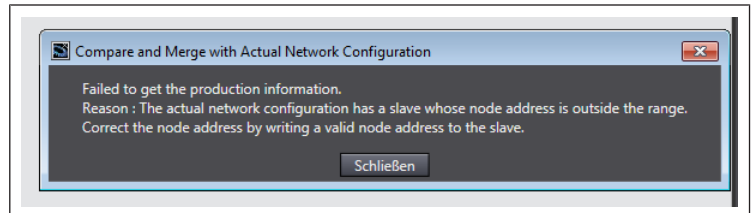

Fig. 1: Errore nell'indirizzo di nodo

Se viene visualizzato il messaggio di errore *Failed to get Production information*, è necessario modificare l'indirizzo di nodo degli apparecchi collegati nel campo consentito (1 ... 192).

Assegnare l'indirizzo EtherCAT

⚠ ATTENZIONE

Pericolo di lesioni a causa di modifiche delle impostazioni durante il funzionamento.

Sono possibili movimenti incontrollati degli attuatori!

► Non modificare mai le impostazioni in fase di funzionamento.

Per poter essere riconosciuto dal comando, l'accoppiatore bus deve avere un indirizzo univoco nella rete EtherCAT.

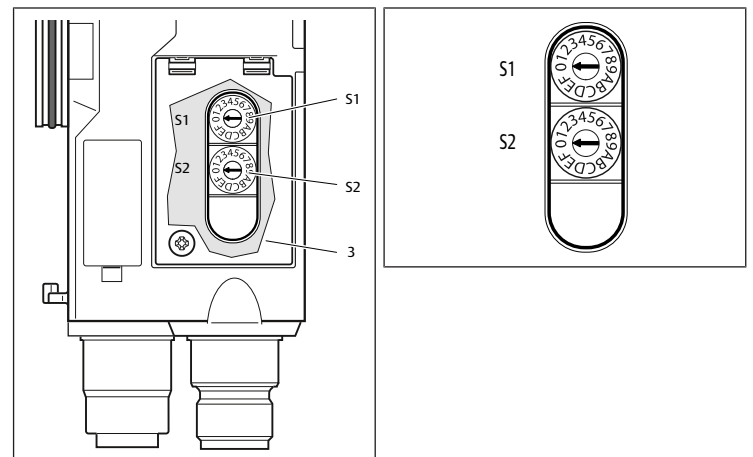

Fig. 2: Selettori indirizzo S1 e S2 sull'accoppiatore bus

Tab. 1: Esempi di indirizzamento

Posizione selettore S1	Posizione selettore S2	Indirizzo della stazione
High nibble	Low nibble	
(dicitura esadecimale)	(dicitura esadecimale)	
0	1	1

Posizione selettore S1	Posizione selettore S2	Indirizzo della stazione
High nibble	Low nibble	
(dicitura esadecimale)	(dicitura esadecimale)	
0	2	2
...
0	F	15
1	0	16
1	1	17
...
9	F	159
A	0	160
...
C	0	192

3 Applicare la configurazione di rete attuale

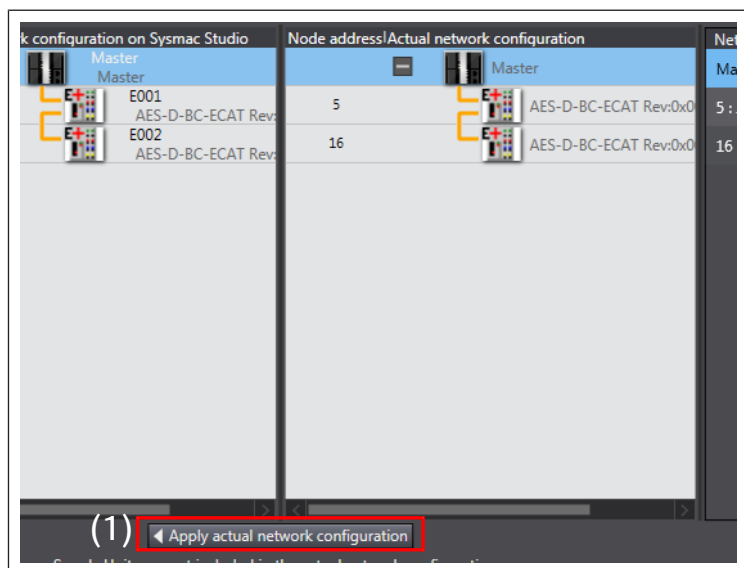

1. Cliccare su *Apply actual network configuration* (1).
2. Cliccare su *Apply* e poi su *confirm*.

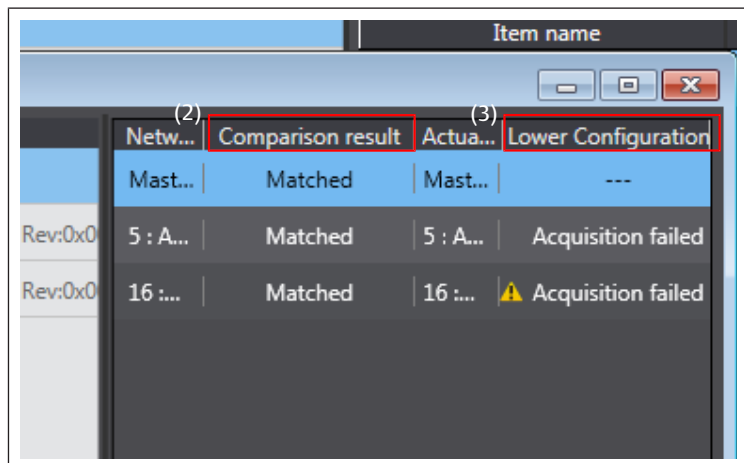

Fig. 3: Configurazione di rete

3. Controllare se in entrambe le colonne *Comparison result* (2) e *Lower configuration* (3) è presente la denominazione *Matched*.

Applicazione della rete attuale non riuscita

Viene visualizzato l'errore *Aquisition failed*:

1. Cancellazione degli apparecchi nel Sysmac Studio.
2. Cliccare su *Apply actual network configuration* (1).

Applicazione della rete attuale modificata

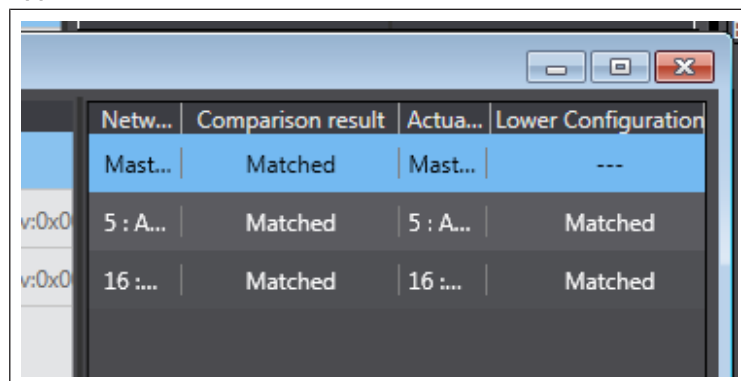

Fig. 4: Configurazione modificata

L'applicazione di rete è riuscita se in entrambe le colonne appare la denominazione "Matched".

- Inviare la configurazione al PLC.

4 Configurare i moduli

Le valvole devono essere aggiunte manualmente alla configurazione prima di avviare la scansione. La restante configurazione può essere ora riconosciuta automaticamente.

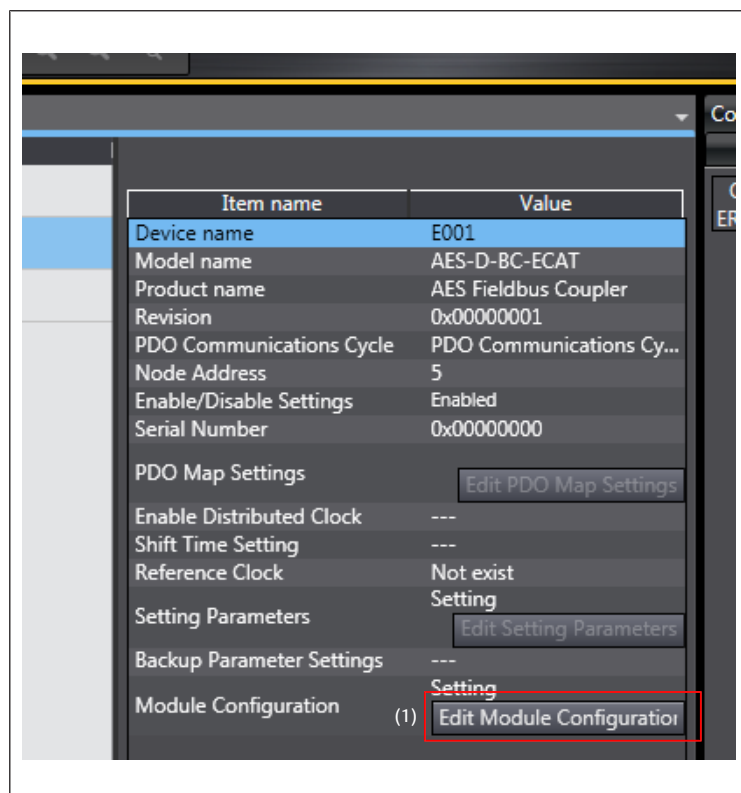

Fig. 5: Modificare la configurazione dei moduli

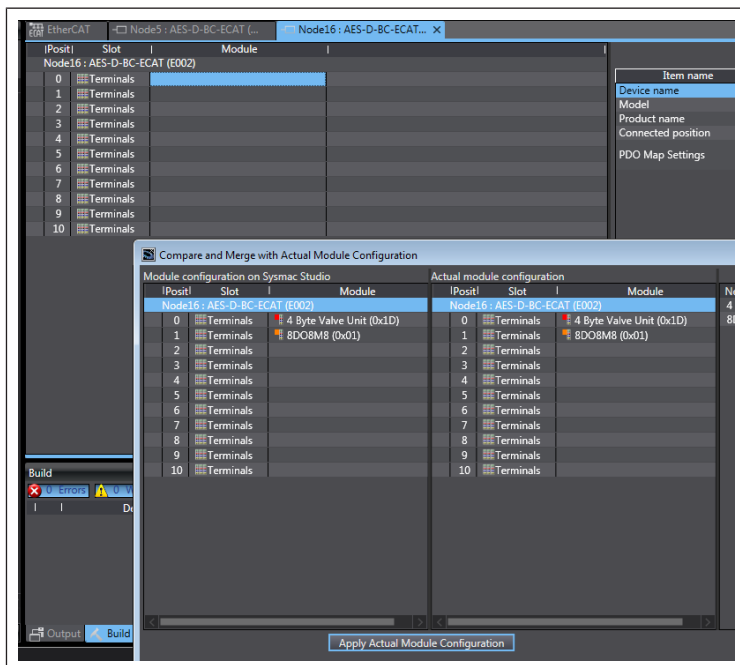

Fig. 6: Applicare la configurazione dei moduli

1. Cliccare su **Edit Module Configuration** per ogni modulo AES.
2. Cliccare con il tasto destro del mouse su **0 Terminal**.
3. Nel menu a discesa selezionare **Compare and Merge with Actual Module Configuration** e confermare con **confirm**.
4. Creare una connessione al PLC (andare **online**).

Modificare i metodi di invio dei moduli

Di default è impostata l'opzione "Do not send".

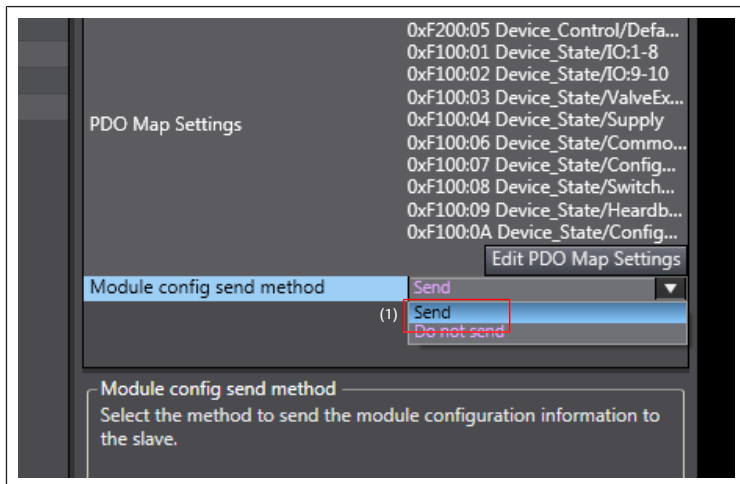
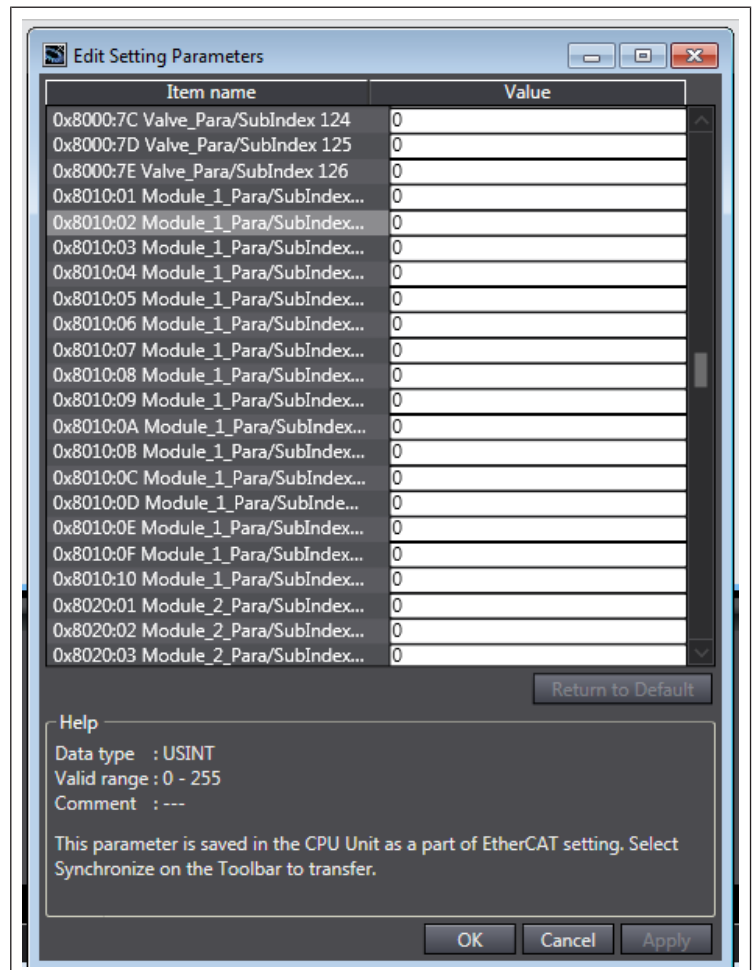
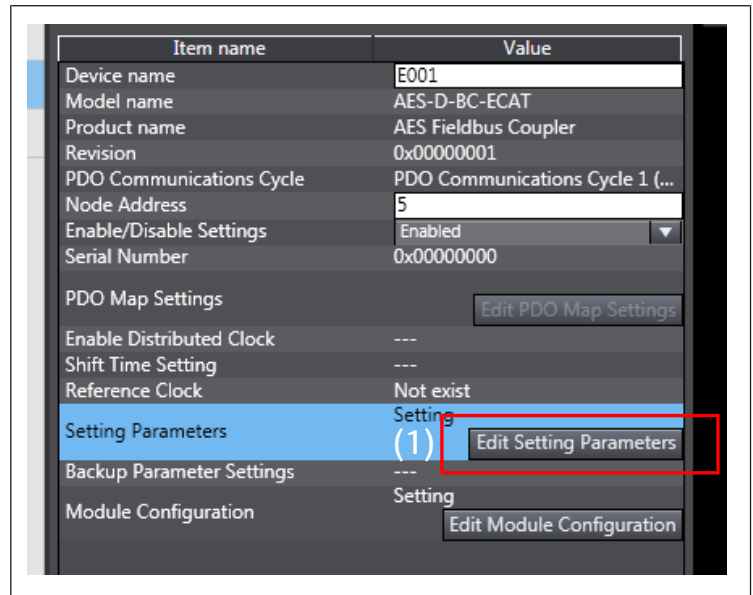

Fig. 7: Impostazione dei metodi di invio

1. Cliccare su **Edit Module Configuration** per ogni modulo AES.
2. Nella riga **Module config send method** (1) selezionare **Send**.
3. Creare una connessione al PLC (andare **online**).
4. Inviare la configurazione al PLC.

5 Impostare i parametri



1. Concludere il collegamento al PLC (andare **offline**).
2. Per modificare i parametri standard, cliccare su **Edit Setting Parameters** (1) per ogni modulo AES.

Viene visualizzato il numero massimo di parametri.

Parametri valvola da 126 byte e parametri dei moduli IO 10x16.

INFO: Vengono trasmessi solo i parametri utilizzati dai moduli AES.

3. Creare una connessione al PLC (andare **online**).

1 Acerca de esta documentación

1.1 Validez de la documentación

Esta documentación es válida para los acopladores de bus de la serie AES para EtherCAT, que se conectan a PLC de OMRON. Esta documentación va dirigida a planificadores de instalaciones eléctricas.

1.2 Documentación necesaria y complementaria

Documentación	Tipo de documento/N.º de material	Comentario
Descripción de sistema del acoplador de bus AES para EtherCAT	Descripción del sistema/R412018142	Archivo PDF en CD Online en Emerson Store

2 Configurar la red

1. Configure el módulo de bus AES EtherCAT, que se conecta al PLC de OMRON.
2. Elimine los siguientes archivos de documentación del directorio "..\OMRON\Systemac Studio\IODeviceProfiles\EsiFiles\UserEsiFiles" en caso de que existan: "AES_EcatKoppler.xml" y "AES_Slot.xml", „AES2_EcatKoppler.xml“ y "AES2_Slot.xml".
3. Guarde los siguientes archivos de configuración en el directorio e inicialice Sysmac Studio: "AES_EcatKoppler_om.xml" "AES2_EcatKoppler_om.xml" "AES_Slot_om.xml" "AES2_Slot_om.xml"

2.1 Comparar las configuraciones de redes y combinarlas

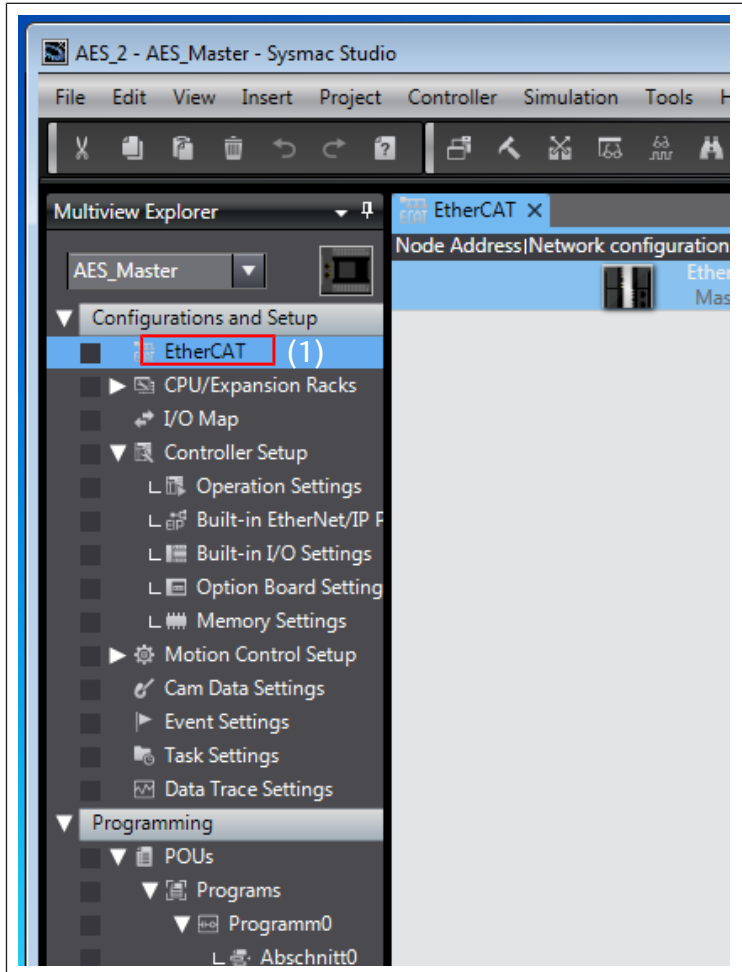

1. Haga doble clic en EtherCAT (1).
2. Cree una conexión a PLC (vaya a **Online**).

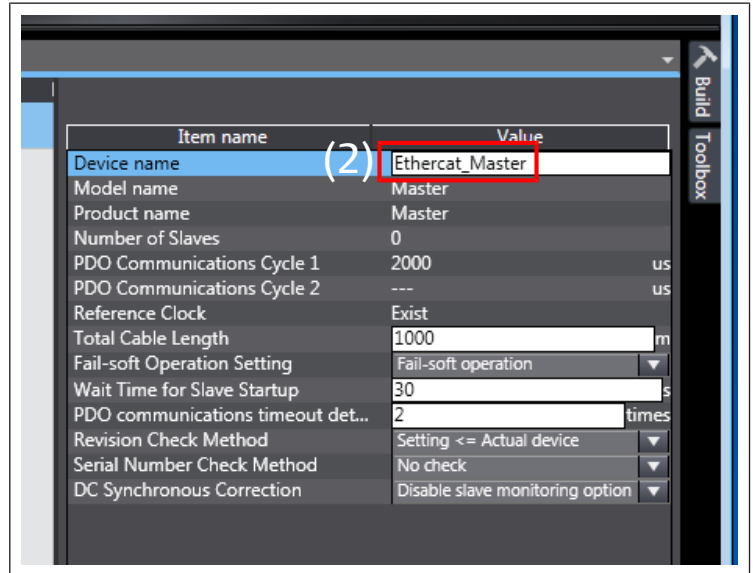

3. Haga clic con el botón derecho en *Ethercat_Master* (2) y, en el menú de opciones, haga clic en *Compare and Merge with Actual Network Configuration*.

Modificar la dirección de nodo

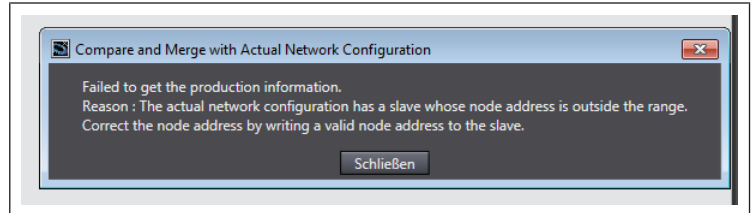

Fig. 1: Error en la dirección de nodo

Si aparece el mensaje de error *Failed to get Production information*, la dirección de nodo del aparato vinculado debe modificarse en el rango autorizado (1 ... 192).

Asignar dirección de EtherCAT

⚠ ATENCIÓN

Peligro de lesiones por modificación de los ajustes durante el funcionamiento

Los actuadores pueden moverse de forma descontrolada.

► Los ajustes nunca se deben modificar durante el funcionamiento en curso.

En la red EtherCAT, el acoplador de bus necesita una dirección única para poder ser reconocido por el control.

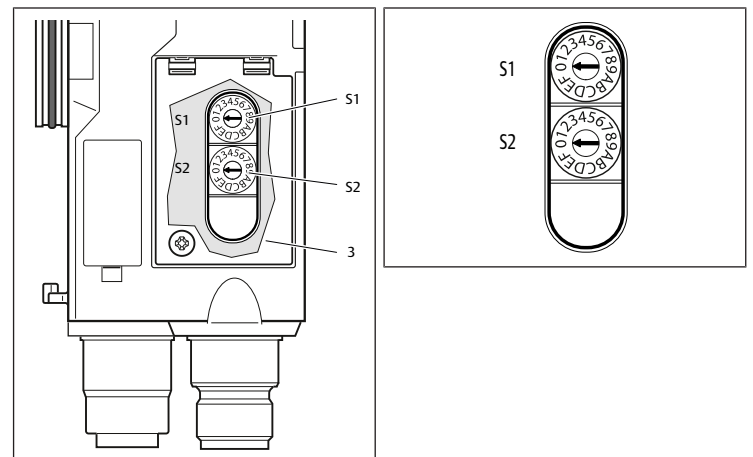

Fig. 2: Conmutadores de dirección S1 y S2 del acoplador de bus

Tab. 1: Ejemplos de asignación de dirección

Posición del conmutador S1	Posición del conmutador S2	Dirección de estación
Nibble High (rotulación hexadecimal)	Nibble Low (rotulación hexadecimal)	
0	1	1

Posición del conmutador S1	Posición del conmutador S2	Dirección de estación
Nibble High (rotulación hexadecimal)	Nibble Low (rotulación hexadecimal)	
0	2	2
...
0	F	15
1	0	16
1	1	17
...
9	F	159
A	0	160
...
C	0	192

3 Aceptar configuración de red actual

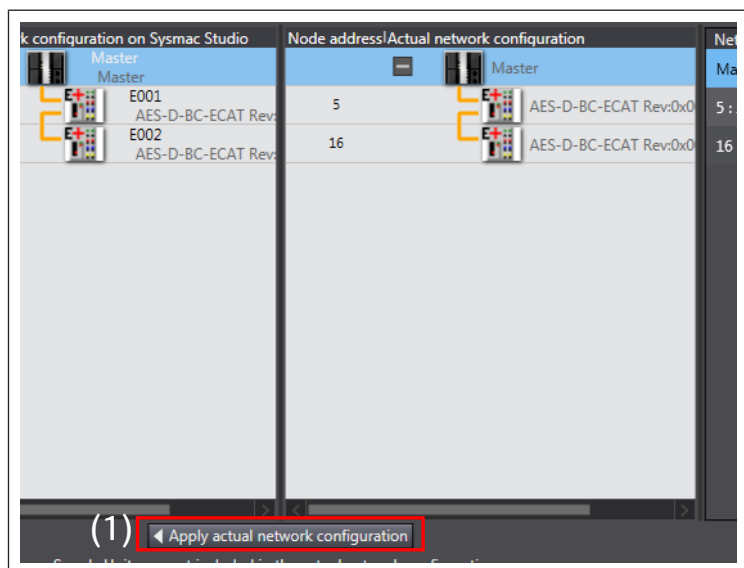

- Haga clic en *Apply actual network configuration* (1).
- Haga clic en *Apply* y, a continuación, en *confirm*.

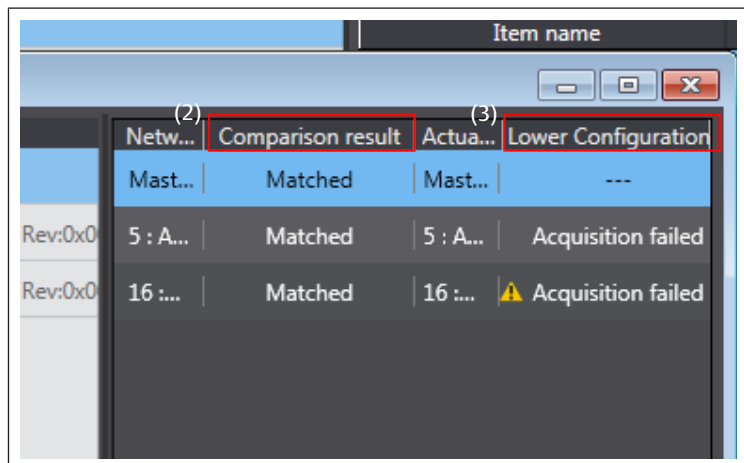

Fig. 3: Configuración de red

- Compruebe si la denominación *Matched* aparece tanto en la columna *Comparison result* (2) como en la columna *Lower configuration* (3).

Ha fallado la configuración de red actual

Si se muestra el error *Aquisition failed*:

- Elimine el aparato de Sysmac Studio.
- Haga clic en *Apply actual network configuration* (1).

Se ha adaptado la configuración de red actual

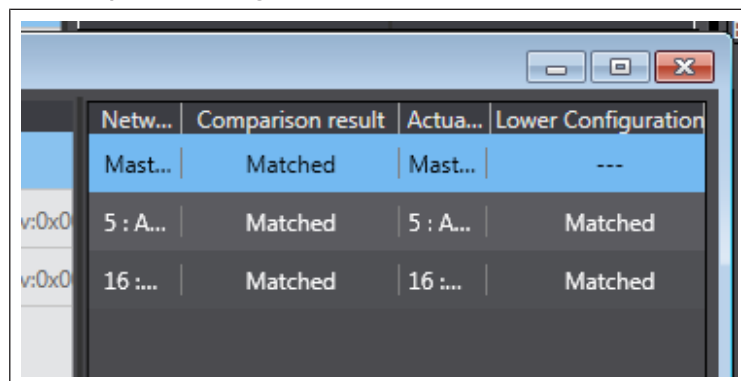

Fig. 4: Se ha adaptado la configuración

Se ha aceptado la red de forma correcta si en ambas columnas aparece la descripción "Matched".

- Enviar configuración a PLC.

4 Configurar módulos

Las válvulas deben añadirse a la configuración de forma manual antes de inicializar el escaneo. El resto de la configuración puede reconocerse ahora de forma automática.

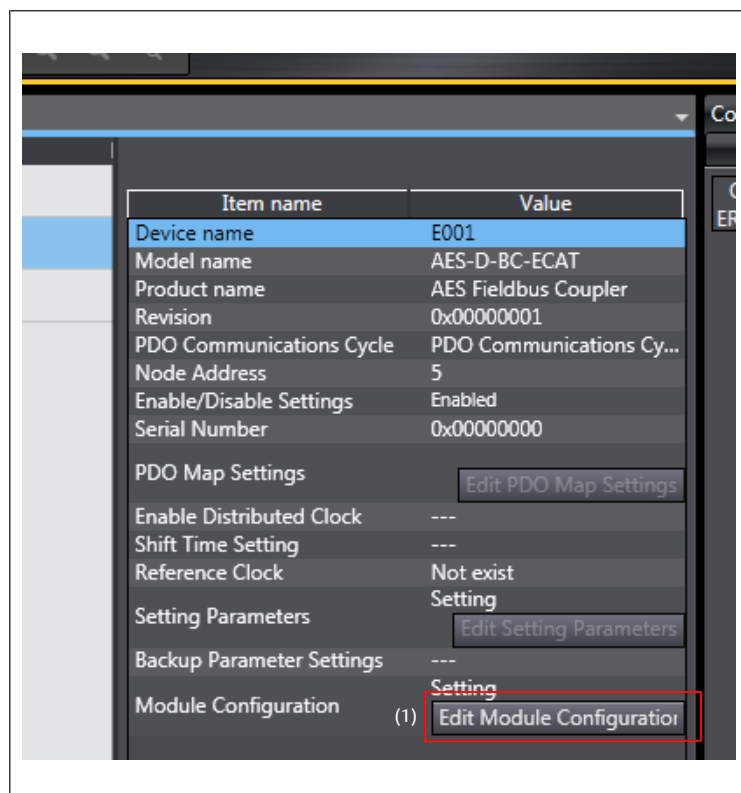

Fig. 5: Editar configuración de módulo

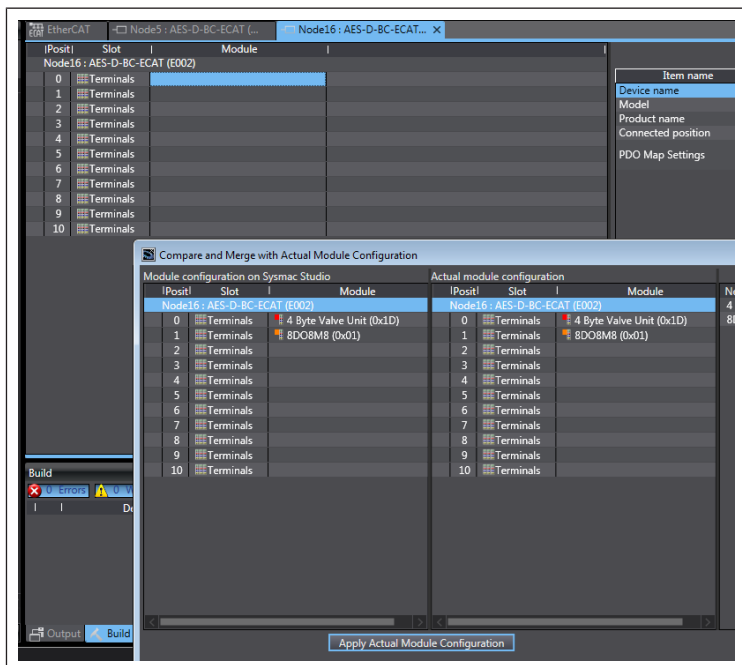

Fig. 6: Aceptar configuración del módulo

1. Haga clic en *Edit Module Configuration* para cada módulo AES.
2. Haga clic con el botón derecho en *0 Terminal*.
3. En el menú de opciones, seleccione *Compare and Merge with Actual Module Configuration* y confirme la selección haciendo clic en *confirm*.
4. Cree una conexión a PLC (vaya a *Online*).

Cambiar los métodos de envío del módulo

"Do not send" está ajustado por defecto.

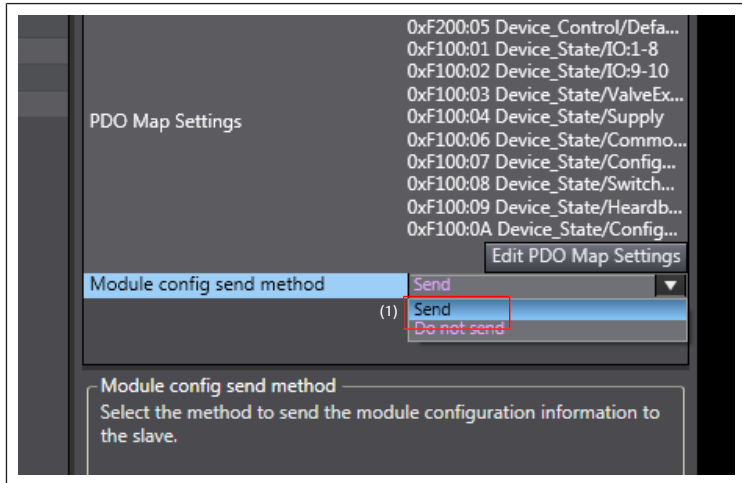
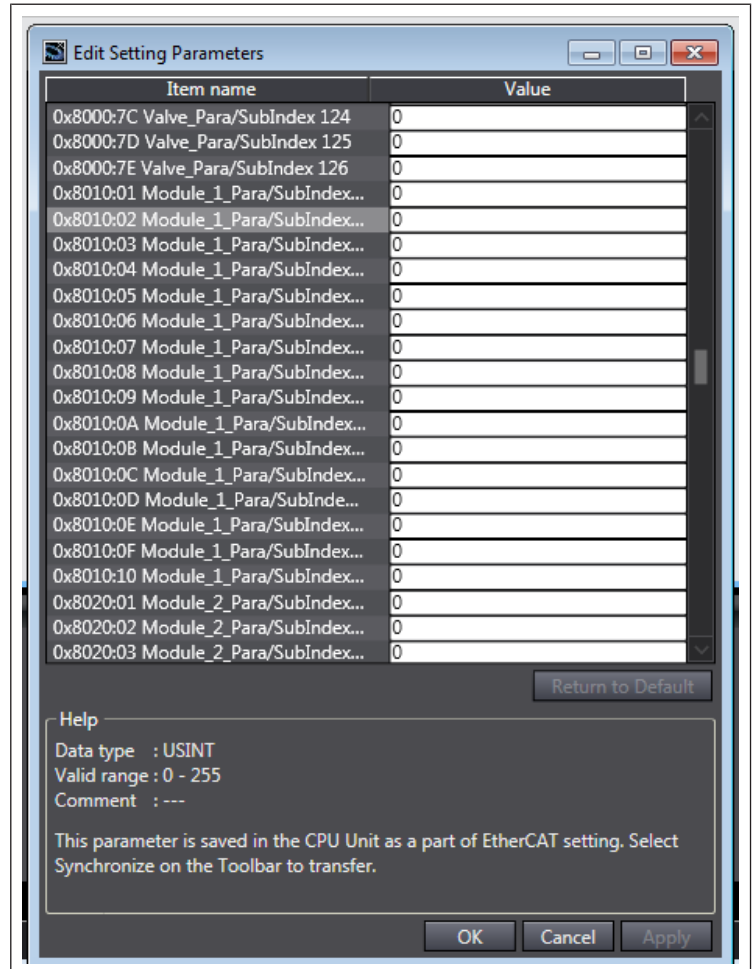
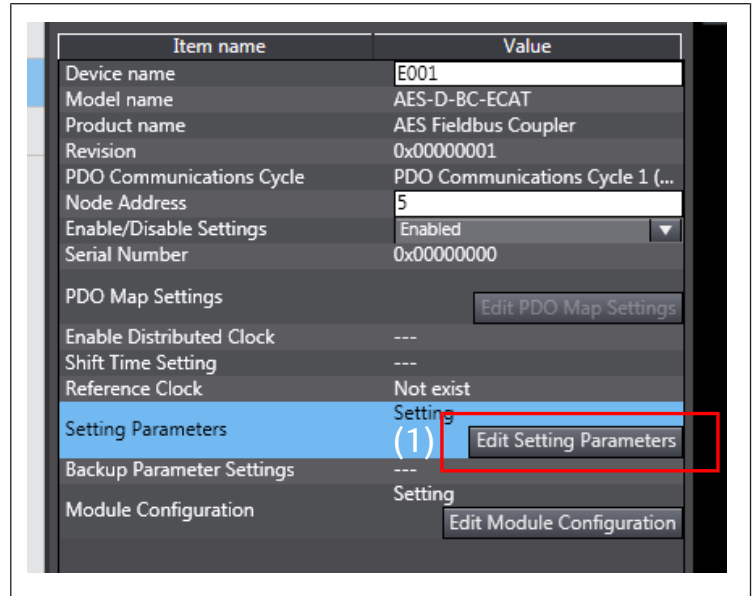

Fig. 7: Ajuste del método de envío

1. Haga clic en *Edit Module Configuration* para cada módulo AES.
2. En la fila *Module config send method* (1), seleccione *Send*.
3. Cree una conexión a PLC (vaya a *Online*).
4. Enviar configuración a PLC.

5 Establecer parámetros



1. Finalizar la conexión al PLC (vaya a *Offline*).
2. Haga clic en *Edit Setting Parameters* (1) para cada módulo AES a fin de modificar los parámetros estándar.

Se muestra el número máximo de parámetros. 126 bytes para el parámetro de válvula y 10x16 para los parámetros de módulo IO.

INFO: Solo se transmiten los parámetros que son modificados desde los módulos AES.

3. Cree una conexión a PLC (vaya a *Online*).

1 Om denna dokumentation

1.1 Dokumentationens giltighet

Denna dokumentation avser fältbussnoderna i serie AES för EtherCAT, som ansluts till en OMRON-PLC. Denna dokumentation riktar sig till programmare och elplanerare.

1.2 Nödvändig och kompletterande dokumentation

Dokumentation	Dokumenttyp/ materialnummer	Anmärkning
AES-fältbussnodens systembeskrivning för EtherCAT	Systembeskrivning/ R412018142	PDF-fil på CD Online i Emerson Store

2 Konfigurera nätverket

1. Konfigurera den AES-EtherCAT-bussmodul som är ansluten till OMRON-PLC.
2. Radera i förekommande fall följande konfigurationsfiler i mappen "..\OMRON\Systemac Studio\IODeviceProfiles\EsiFiles\UserEsiFiles":
"AES_EcatKoppler.xml" och "AES_Slot.xml",
"AES2_EcatKoppler.xml" och "AES2_Slot.xml".
3. Spara och starta följande nya konfigurationsfiler i mappen och Sysmac Studio:
"AES_EcatKoppler_om.xml"
"AES2_EcatKoppler_om.xml"
"AES_Slot_om.xml"
"AES2_Slot_om.xml"

2.1 Jämför och sammanför nätverkskonfigurationerna

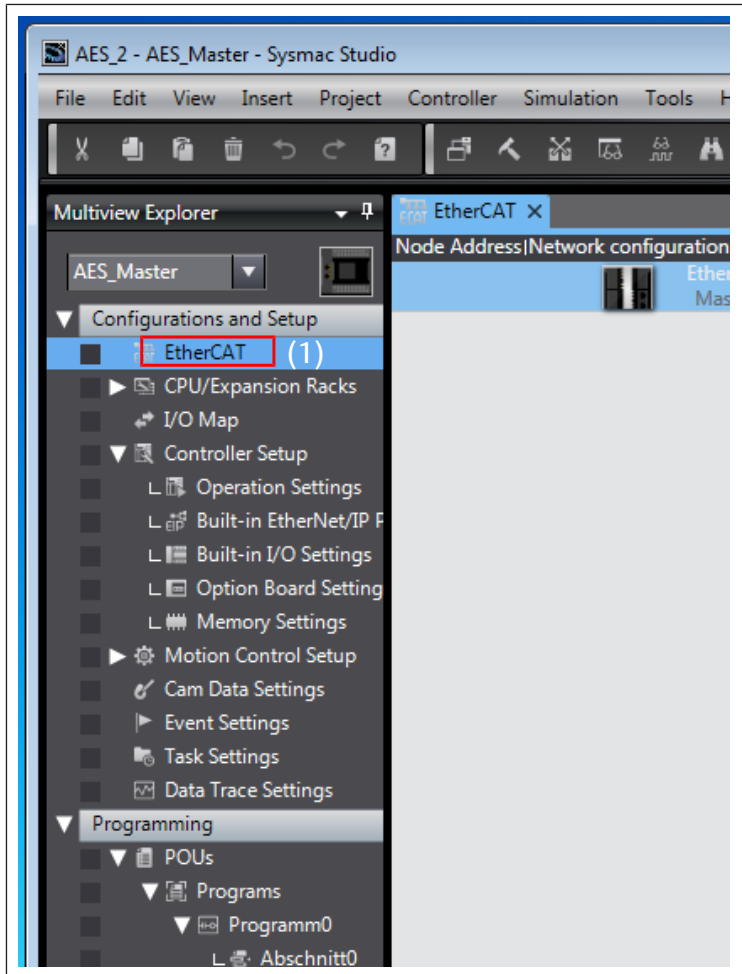

1. Dubbelklicka på EtherCAT (1).
2. Upprätta anslutning till PLC (gå *online*).

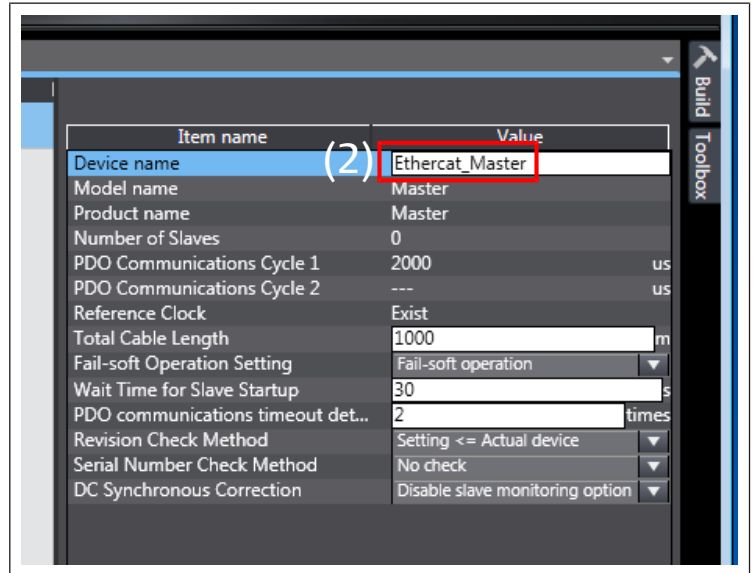

3. Högerklicka på *Ethercat_Master* (2) och välj i urvalsmenyn *Compare and Merge with Actual Network Configuration*.

Ändra nodadress



Bild 1: Fel på nodadressen

Om felmeddelandet *Failed to get Production information* visas, måste de anslutna apparaternas nodadress ändras till det tillåtna området (1 ... 192).

EtherCAT-adressen tilldelad

⚠ SE UPP

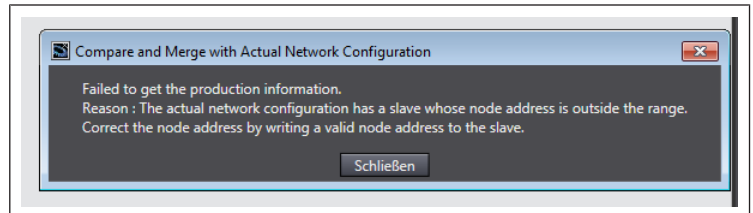
Risk för skador på grund av inställningsändringar under drift
Okontrollerade rörelser kan uppstå!

► Ändra aldrig inställningarna under pågående drift.

Fältbussnoden behöver en unik adress i EtherCAT-nätverket för att styrsystemet ska kunna identifiera den.



Bild 2: Adressomkopplare S1 och S2 på fältbussnoden

Tab. 1: Adresseringsexempel

Omkopplarläge S1	Omkopplarläge S2	Stationsadress
High-nibble	Low-nibble	
(hexadecimal märkning)	(hexadecimal märkning)	
0	1	1
0	2	2
...

Omkopplarläge S1	Omkopplarläge S2	Stationsadress
High-nibble	Low-nibble	
(hexadecimal märkning)	(hexadecimal märkning)	
0	F	15
1	0	16
1	1	17
...
9	F	159
A	0	160
...
C	0	192

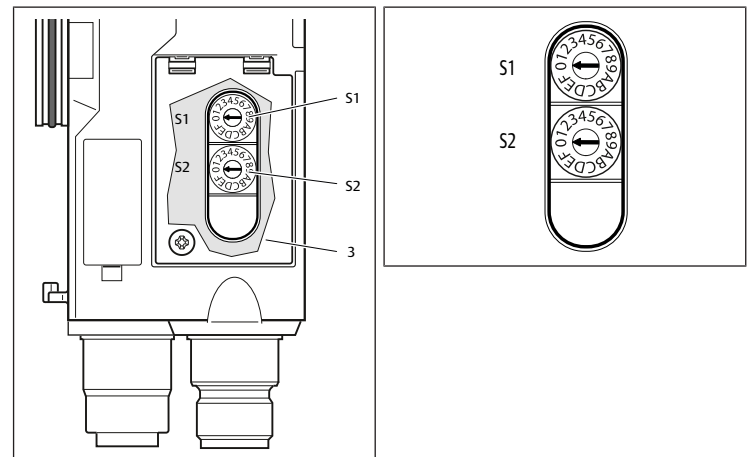
3 Godkänn aktuell nätverkskonfiguration

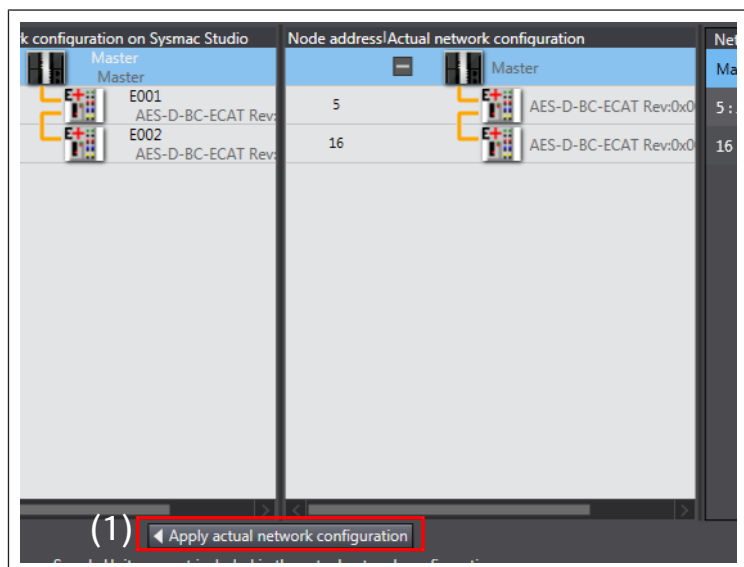

1. Klicka på *Apply actual network configuration* (1).
2. Klicka på *Apply* och sedan på *confirm*.



Bild 3: Nätverkskonfiguration

3. Kontrollera om beteckningen *Matched* visas i de båda kolumnerna *Comparison result* (2) och *Lower configuration* (3).

Godkännande av aktuellt nätverk misslyckades

Felet *Aquisition failed* visas:

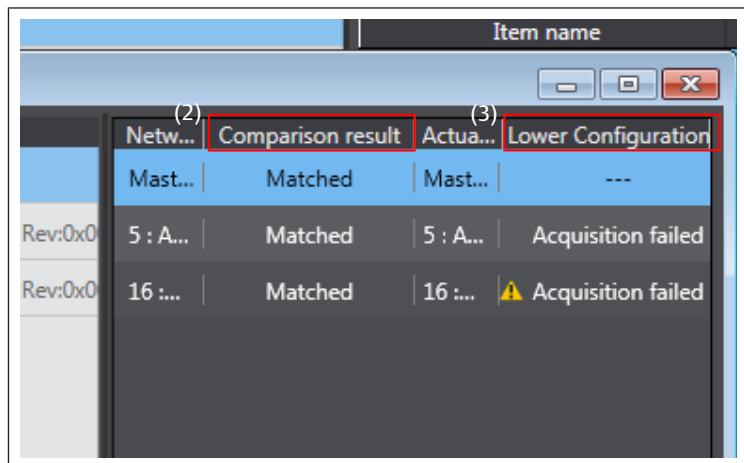
1. Radera apparaterna i Sysmac Studio.
2. Klicka på *Apply actual network configuration* (1).

Godkännande av aktuellt nätverk anpassat



Bild 4: Konfiguration anpassad

Godkännandet av nätverket har lyckats om beteckningen "Matched" visas i båda kolumnerna.

- Skicka konfigurationen till PLC.

4 Konfigurera moduler

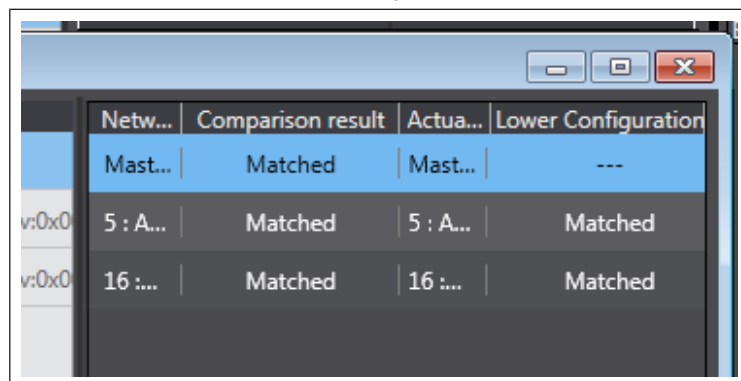
Ventilerna måste manuellt läggas till i konfigurationen innan skanningen startas. Den resterande konfigurationen kan identifieras automatiskt.



Bild 5: Redigera modulkonfigurationen



Bild 6: Godkänn modulkonfigurationen

1. Klicka på **Edit Module Configuration** för varje AES-modul.
2. Högerklicka på **0 Terminal**.
3. Välj i urvalsmenyn **Compare and Merge with Actual Module Configuration** och bekräfta med **confirm**.
4. Upprätta anslutning till PLC (gå **online**).

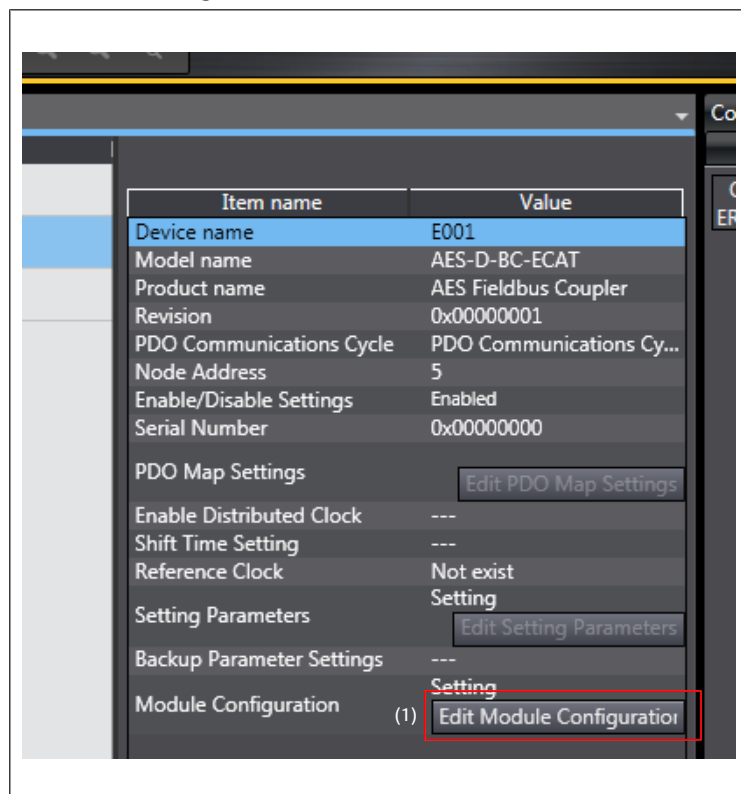
Ändra modulsändningsmetod

Som standard är "Do not send" inställd.

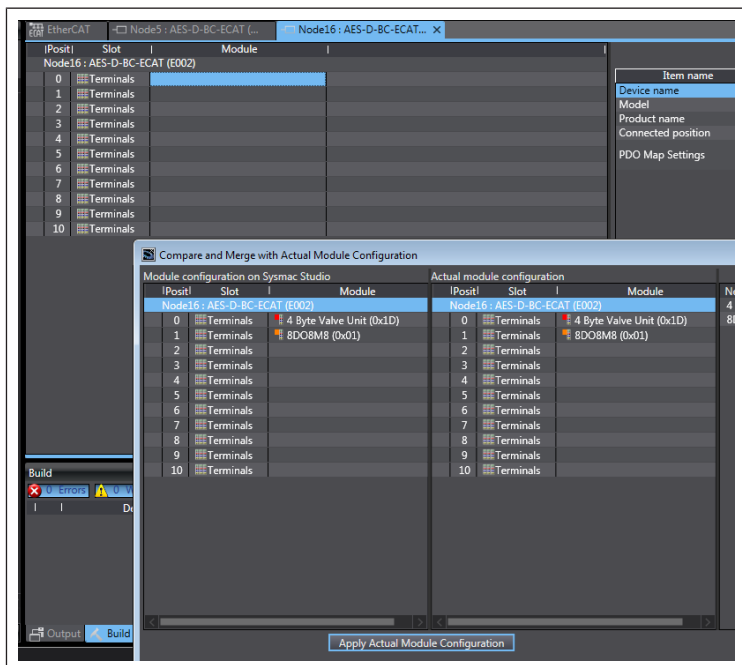

Bild 7: Inställning av sändningsmetoden

1. Klicka på **Edit Module Configuration** för varje AES-modul.
2. Välj i raden **Module config send method** (1) **Send**.
3. Upprätta anslutning till PLC (gå **online**).
4. Skicka konfigurationen till PLC.

5 Inställning av parametrar

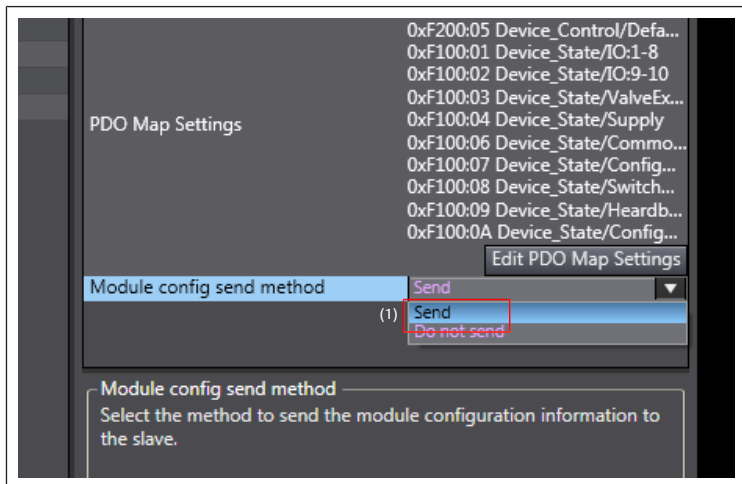
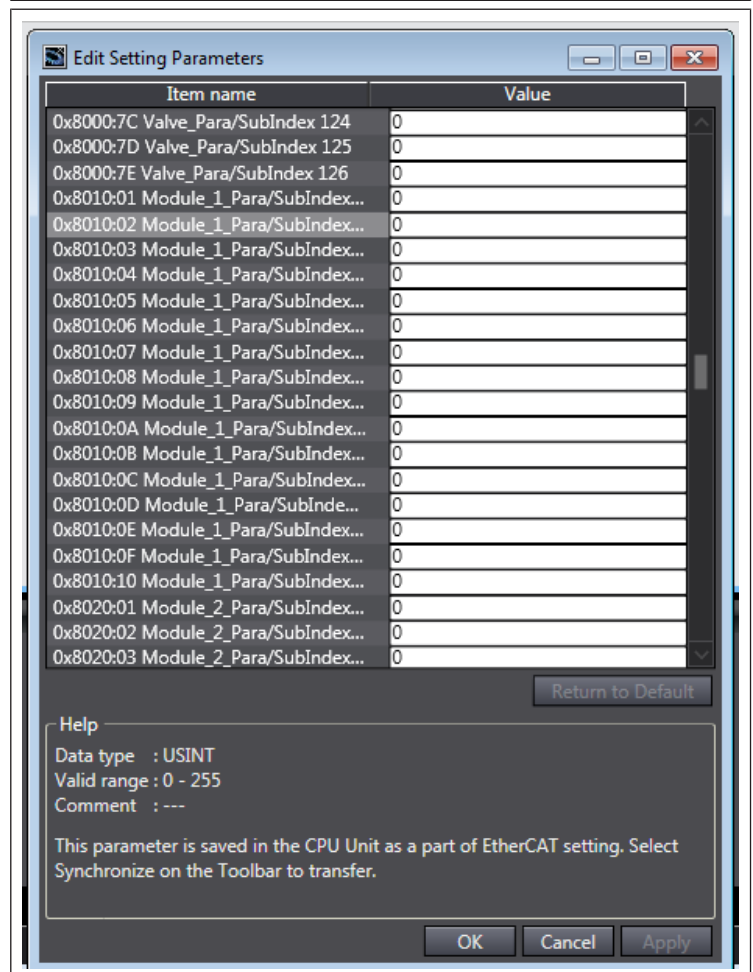
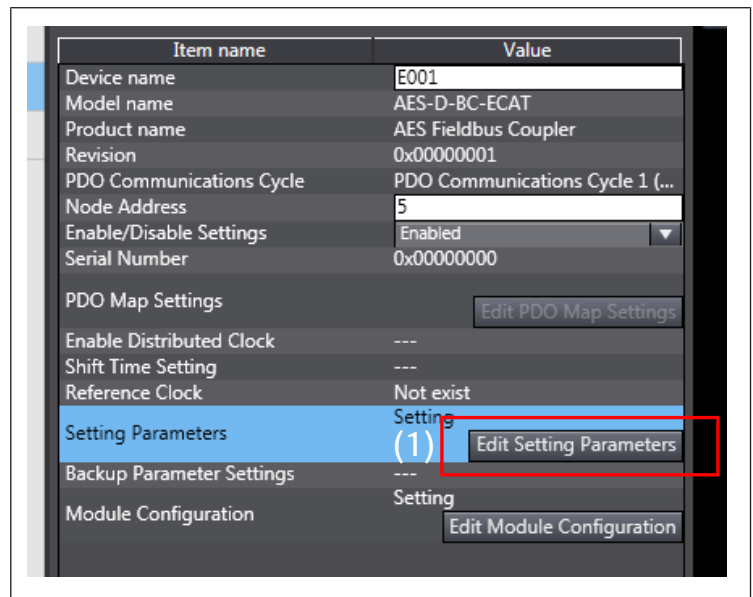

1. Avsluta anslutningen till PLC (gå **offline**).
2. Klicka på **Edit Setting Parameters** (1) för varje AES-modul för att ändra standardparametrarna.

Det maximala antalet parametrar visas.

126 bytes ventilparametrar och 10x16 IO-modulparametrar.

INFO: Endast de parametrar som används av AES-modulerna överförs.

3. Upprätta anslutning till PLC (gå **online**).

Emerson Automation Solutions

AVENTICS GmbH
Ulmer Straße 4
30880 Laatzen, GERMANY
phone +49 511 2136-0
fax +49 511 2136-269
www.emerson.com/aventics
aventics@emerson.com

Further addresses:
www.emerson.com/contactus

The data specified above only serve to describe the product. No statements concerning a certain condition or suitability for a certain application can be derived from our information. The given information does not release the user from the obligation of own judgement and verification. It must be remembered that our products are subject to a natural process of wear and aging.

An example configuration is depicted on the title page. The delivered product may thus vary from that in the illustration.

Translation of the original operating instructions. The original operating instructions were created in the German language.

Subject to modifications. © All rights reserved by AVENTICS GmbH, even and especially in cases of proprietary rights applications. This document may not be reproduced or given to third parties without our consent.

The Emerson logo is a trademark and service mark of Emerson Electric Co. AVENTICS is a mark of one of the Emerson Automation Solutions family of business units. All other marks are property of their respective owners.

