



AMS Accessories

REFERENCE GUIDE

AMS



AMS 2140 Machinery Health

AMS 2140 (all options)



Strobelight Cables

D25535 MODEL 555 STROBE INTERFACE CABLE - 2 connections to Strobelight



Extension Cables

MHM-65003-PBF 4-CH ADAPTER ACCEL INTERFACE CABLE 0.2M
MHM-65004-PBF ACCEL EXT CABLE. 5P M12 TO 5P M12 2M BLACK

Triaxial Cable

D25777 TRIAXIAL ACCEL CABLE, FW STRAIGHT 5P M12 TO 5P 1/2IN-20UNF

Channel A Cables

D25782 CH A ACCEL CABLE 5P M12 TO 2P MIL COILED 6FT BLACK - FIELD WIREABLE
D25480 CH A ACCEL CABLE 5P M12 TO 2P MIL STRAIGHT 5FT RED
D25483 CH A ACCEL CABLE 5P M12 TO BNC STRAIGHT 2M RED

Channel B Cables

D25481 CH B ACCEL CABLE 5P M12 TO 2P MIL STRAIGHT 5FT BLUE
D25484 CH B ACCEL CABLE 5P M12 TO BNC STRAIGHT 2M BLUE

Channel D Cables

D25525 CH D ACCEL CABLE, STRAIGHT BLACK 5PIN M12 TO BNC
D25526 H D ACCEL CABLE, STRAIGHT BLACK 5PIN M12 TO 2PIN MIL

Breakaway Cable

D25543 BREAKAWAY ACCEL CABLE ASM, 6FT. COILED, 5 PIN M12 CONN TO 2 PIN MIL CONN, CONSISTS OF TWO PARTS

Extension Cables

MHM-65006-PBF 4-CH VOLTS INTERFACE CABLE 8P M12 TO 8P M12 0.2M
MHM-65007-PBF TACH/VOLTS EXT CABLE 8P M12 TO 8P M12 2M BLACK

Volts Cables

D25479 CH A VOLTS CABLE 8P M12 TO BNC 4FT BLACK
D25506 2 WAY SPLITTER CABLE 8P M12 TO 2X BNC, VOLTS A, B
D25688 3 WAY SPLITTER CABLE 8P M12 TO 3X BNC 0.2M VOLTS A, B, TACH

SpeedVue Cables

D25473 SPEEDVUE CABLE 8P M12 TO 4P LEMO 24IN – used with SpeedVue
D25474 SPEEDVUE CABLE 8P M12 TO 4P LEMO 42IN BLACK – used with SpeedVue
D25475 SPEEDVUE CABLE 8P M12 TO 4P LEMO 6FT – used with SpeedVue

Phototach Cables

D25472 TACH CABLE 8P M12 TO BNC 4FT BLACK – used with Phototach
D25476 TACH CABLE 8P-M12 TO AMP CONNECTOR 2M BLACK – used with Phototach



D25494 CH A ACCEL CABLE 2P MIL TO 3P HALF BREAKAWAY COILED 6FT BLACK
D25495 CH A ACCEL CABLE 5P MIL TO 3P HALF BREAKAWAY 15IN BLACK

AMS 2140 – Multi-channel input (all options)



+

OR



Volt Side



Accel Side

D25504	Accel splitter cable A and B, M12 to 2X BNC
D25505	Accel splitter cable C and D, M12 to 2X BNC
D25506	Volts A and B M12 to BNC splitter cable
D25688	3 WAY SPLITTER CABLE 8P M12 TO BNC 0.2M VOLTS A, VOLTS B, TACH

(For Non-Hazardous Areas ONLY)

A40ADPTR	4CH INPUT ADAPTER PACKAGE - WRAPS AROUND THE BACK OF THE AMS 2140 AND IS REVERSIBLE FOR USING UP TO 4 SENSOR INPUTS PLUS A TACHOMETER INPUT. ACCEL INPUTS ON ONE SIDE AND VOLT INPUTS ON THE OTHER. NOTE: Not approved for use in hazardous rated areas. Can be used with the shoulder strap. This P/N ships with 2 connector cables: <ul style="list-style-type: none"> ■ MHM-65003-PBF (replaced D25501) ■ MHM-65006-PBF (replaced D25502)
B40ADPTR	4CH Input Adapter only (WITHOUT CABLES).

AMS 2140 – A40ADPTR Input Adapter: ACCEL

(Non-Hazardous Areas ONLY)

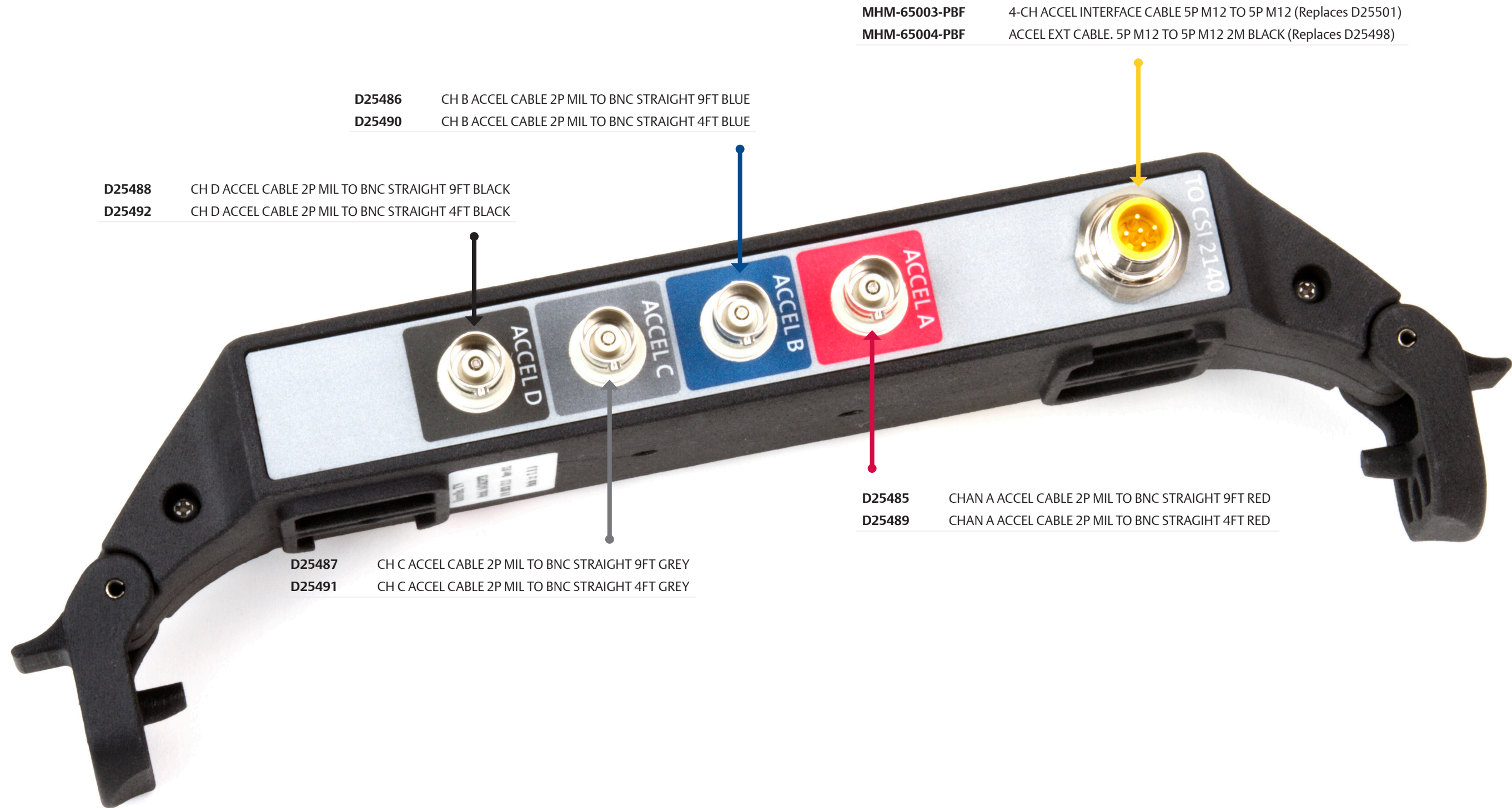

MHM-65003-PBF 4-CH ACCEL INTERFACE CABLE 5P M12 TO 5P M12 (Replaces D25501)
MHM-65004-PBF ACCEL EXT CABLE. 5P M12 TO 5P M12 2M BLACK (Replaces D25498)

D25486 CH B ACCEL CABLE 2P MIL TO BNC STRAIGHT 9FT BLUE
D25490 CH B ACCEL CABLE 2P MIL TO BNC STRAIGHT 4FT BLUE

D25488 CH D ACCEL CABLE 2P MIL TO BNC STRAIGHT 9FT BLACK
D25492 CH D ACCEL CABLE 2P MIL TO BNC STRAIGHT 4FT BLACK

D25487 CH C ACCEL CABLE 2P MIL TO BNC STRAIGHT 9FT GREY
D25491 CH C ACCEL CABLE 2P MIL TO BNC STRAIGHT 4FT GREY

D25485 CHAN A ACCEL CABLE 2P MIL TO BNC STRAIGHT 9FT RED
D25489 CHAN A ACCEL CABLE 2P MIL TO BNC STRAGIHT 4FT RED

AMS 2140 – A40ADPTR Input Adapter: VOLTS

(Non-Hazardous Areas ONLY)

For Use with SpeedVue (Provides Power)

- D25473 SPEEDVUE CABLE 8P M12 TO 4P LEMO 24IN
- D25474 SPEEDVUE CABLE 8P M12 TO 4P LEMO 42IN BLACK
- D25475 SPEEDVUE CABLE 8P M12 TO 4P LEMO 6FT

For Use with 404 Phototach (Provides Power)

- D25472 TACH CABLE 8P M12 TO BNC 4FT BLACK
- D25476 TACH CABLE 8P-M12 TO AMP CONNECTOR 2M BLACK

Extension Cables

- MHM-65006-PBF 4-CH VOLTS INTERFACE CABLE 8P M12 TO 8P M12 0.2M
- MHM-65007-PBF TACH/VOLTS EXT CABLE 8P M12 TO 8P M12 2M BLACK

NOTE: Input for Self-Powered Tach Signal

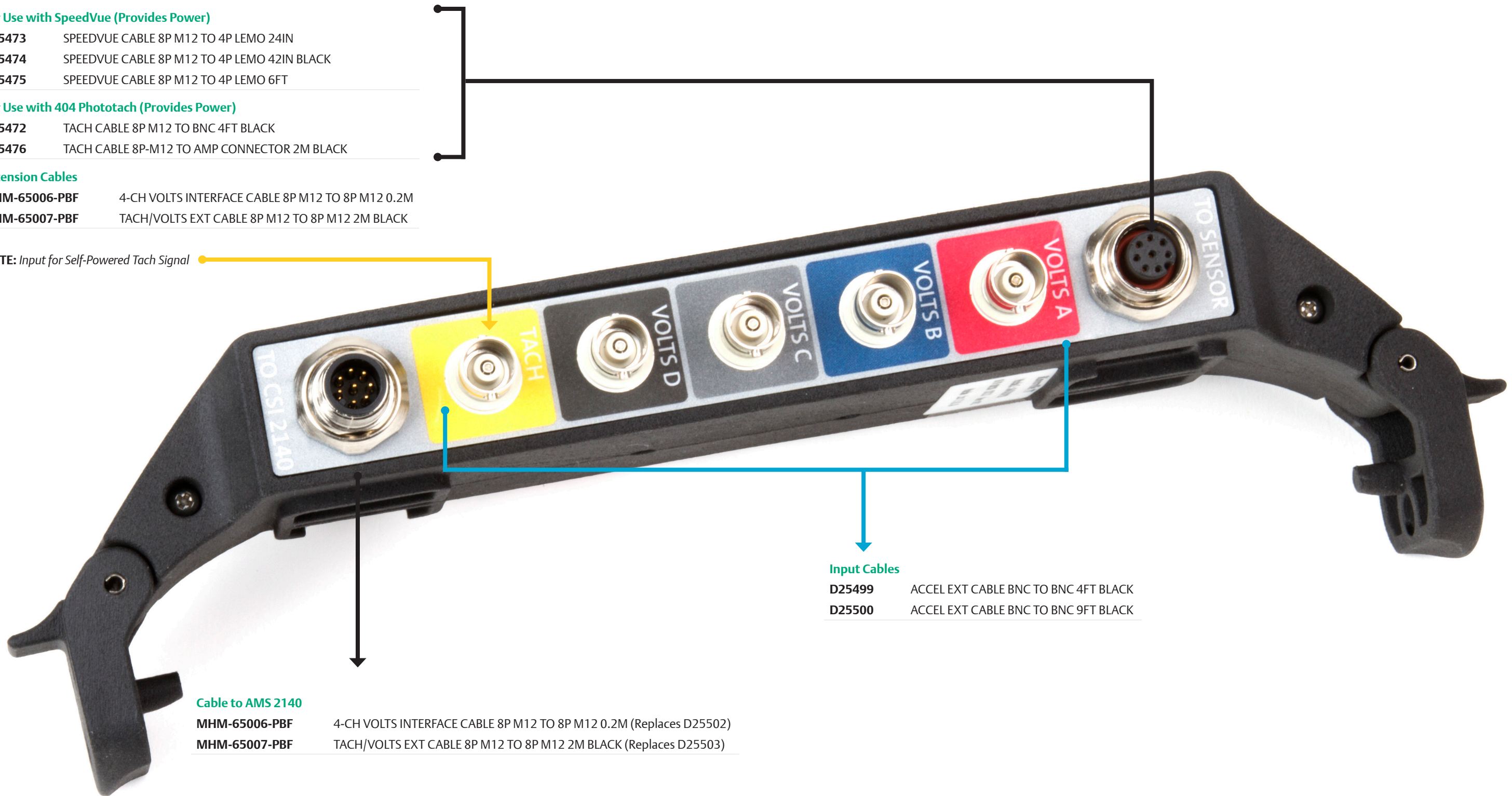

Cable to AMS 2140

- MHM-65006-PBF 4-CH VOLTS INTERFACE CABLE 8P M12 TO 8P M12 0.2M (Replaces D25502)
- MHM-65007-PBF TACH/VOLTS EXT CABLE 8P M12 TO 8P M12 2M BLACK (Replaces D25503)

Input Cables

- D25499 ACCEL EXT CABLE BNC TO BNC 4FT BLACK
- D25500 ACCEL EXT CABLE BNC TO BNC 9FT BLACK

AMS 2140

(Single Input in Hazardous Areas)*



Triaxial Cable

D25777 TRIAXIAL ACCEL CABLE, FW STRAIGHT 5P M12 TO 5P 1/2IN-20UNF

Channel A Cables

D25782 CH A ACCEL CABLE 5P M12 TO 2P MIL COILED 6FT BLACK - FIELD WIREABLE

D25480 CH A ACCEL CABLE 5P M12 TO 2P MIL STRAIGHT 5FT RED

D25483 CH A ACCEL CABLE 5P M12 TO BNC STRAIGHT 2M RED

Channel B Cables

D25481 CH B ACCEL CABLE 5P M12 TO 2P MIL STRAIGHT 5FT BLUE

D25484 CH B ACCEL CABLE 5P M12 TO BNC STRAIGHT 2M BLUE

Channel D Cables

D25525 CH D ACCEL CABLE, STRAIGHT BLACK 5PIN M12 TO BNC

D25526 CH D ACCEL CABLE, STRAIGHT BLACK 5PIN M12 TO 2PIN MIL

Breakaway Cable

D25543 BREAKAWAY ACCEL CABLE ASM, 6FT. COILED, 5 PIN M12 CONN TO 2 PIN MIL CONN, CONSISTS OF TWO PARTS

Volts Cable

D25506 2 WAY SPLITTER CABLE 8P M12 TO 2X BNC, VOLTS A, B

NOTE: Any connections to this port must adhere to the permissible entity parameters.*



A0643TX-EX



A0761GP-EX



A0761GP-EX



AMS 2140 (Multi-sensor input in Hazardous Areas)*

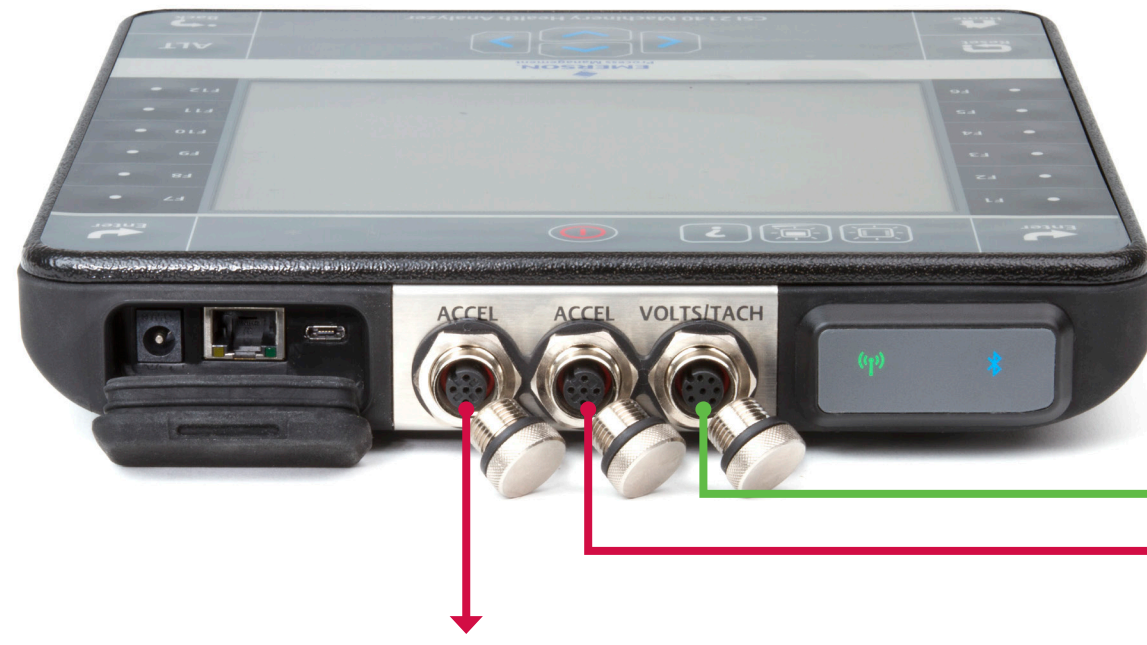

D25504 Accel splitter cable A and B, M12 to 2X BNC

- D25485** CH A ACCEL CABLE 2P MIL TO BNC STRAIGHT 9FT RED
- D25489** CH A ACCEL CABLE 2P MIL TO BNC STRAGIHT 4FT RED
- D25486** CH B ACCEL CABLE 2P MIL TO BNC STRAIGHT 9FT BLUE
- D25490** CH B ACCEL CABLE 2P MIL TO BNC STRAIGHT 4FT BLUE

D25505 Accel splitter cable C and D, M12 to 2X BNC

- D25487** CH C ACCEL CABLE 2P MIL TO BNC STRAIGHT 9FT GREY
- D25491** CH C ACCEL CABLE 2P MIL TO BNC STRAIGHT 4FT GREY
- D25488** CH D ACCEL CABLE 2P MIL TO BNC STRAIGHT 9FT BLACK
- D25492** CH D ACCEL CABLE 2P MIL TO BNC STRAIGHT 4FT BLACK

D25506 Volts A and B M12 to BNC splitter cable

NOTE: Any connections to this port must adhere to the permissible entity parameters.*



A0761GP-EX



Extension Cables

- D25499** ACCEL EXT CABLE BNC TO BNC 4FT BLACK
- D25500** ACCEL EXT CABLE BNC TO BNC 9FT BLACK

AMS 2140 Model String Options Power and Storage Solutions

External Charging Kit (Option “E”)



A40EXCHRG
EXTERNAL BATTERY CHARGER



B2140BATPACK
BATTERY PACK



MHM-93046-PBF
POWER SUPPLY, EXTERNAL, DESKTOP UNIV AC LINE-IN, 15VDC@4A OUT



Use the external battery charger to charge the spare battery pack. Swap the battery packs when you need extra run time.

Hard Shell Carry Case (Option “H”)



A2140CASE
HARDSHELL CASE - VERY DURABLE, IMPACT RESISTANT, WATERPROOF, PELICAN HARD SIDED CARRY CASE FOR THE AMS 2140

AMS 2140 Model String Options – Sensor Kits (Option “K”) 4 Sensor Kit with Accessories for Multi-Channel Analysis

A21404CHACC-ADV

Non-rated

Item	Description	Qty
B40ADPTR	4CH Input Adapter - Wraps around the back of AMS 2140	1
A0760GP	ACCEL, 100MV/G \pm 5%, 0.5HZ-10KHZ, IP68, CE	4
A090835	MAGNET 2 POLE, 1IN CURVED SURFACE	4
D25489	CH A ACCEL CABLE 2P MIL TO BNC 4FT RED	1
D25490	CH B ACCEL CABLE 2P MIL TO BNC 4FT BLUE	1
D25491	CH C ACCEL CABLE 2P MIL TO BNC 4FT GREY	1
D25492	CH D ACCEL CABLE 2P MIL TO BNC 4FT BLACK	1
D25499	ACCEL EXT CABLE BNC TO BNC 4FT BLACK	4
D25504	ACCEL SPLITTER CABLE - A & B 5P M12 TO 2XBNC	1
D25505	ACCEL SPLITTER CABLE - C & D 5P M12 TO 2XBNC	1
MHM-65006-PBF	VOLTS ADAPTER INTERFACE CABLE, 0.2M	1
MHM-65003-PBF	ACCEL ADAPTER INTERFACE CABLE, 0.2M	1

A2140Q4CHACC-ADV

Rated (For use with Option “KL” or “EX”)

Item	Description	Qty
A0761GP-EX	IS ACCEL, 100MV/G \pm 5%, 0.5HZ-10KHZ, IP68, CE	4
A090835	MAGNET 2 POLE, 1IN CURVED SURFACE	4
D25489	CH A ACCEL CABLE 2P MIL TO BNC 4FT RED	1
D25490	CH B ACCEL CABLE 2P MIL TO BNC 4FT BLUE	1
D25491	CH C ACCEL CABLE 2P MIL TO BNC 4FT GREY	1
D25492	CH D ACCEL CABLE 2P MIL TO BNC 4FT BLACK	1
D25499	ACCEL EXT CABLE BNC TO BNC 4FT BLACK	4
D25504	ACCEL SPLITTER CABLE - A & B 5P M12 TO 2XBNC	1
D25505	ACCEL SPLITTER CABLE - C & D 5P M12 TO 2XBNC	1
D25506	VOLT SPLITTER CABLE - A & B 8P M12 TO 2XBNC	1

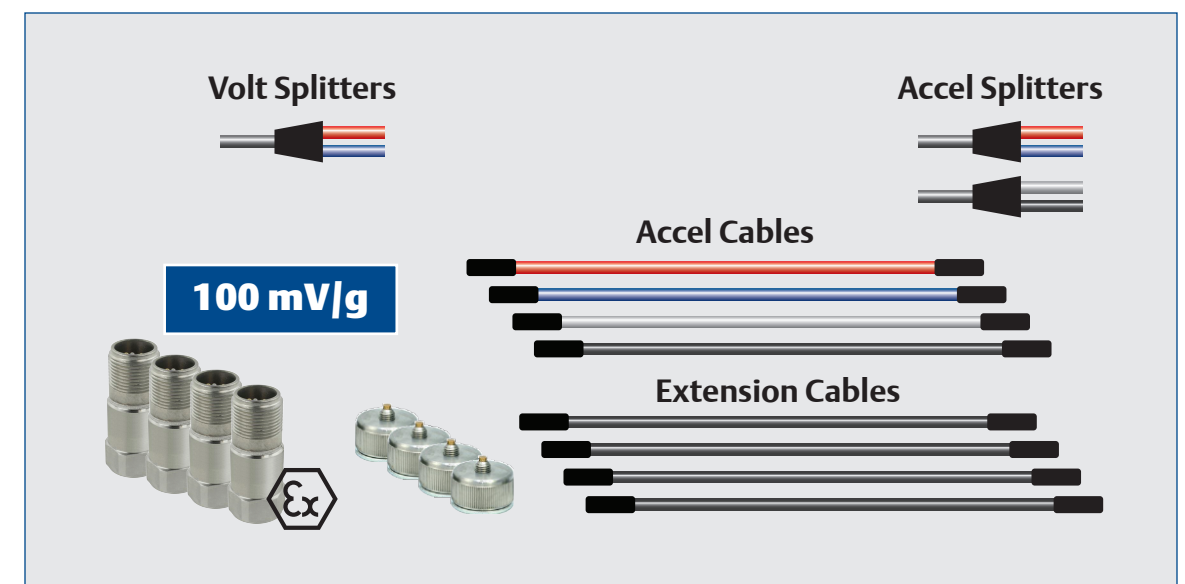
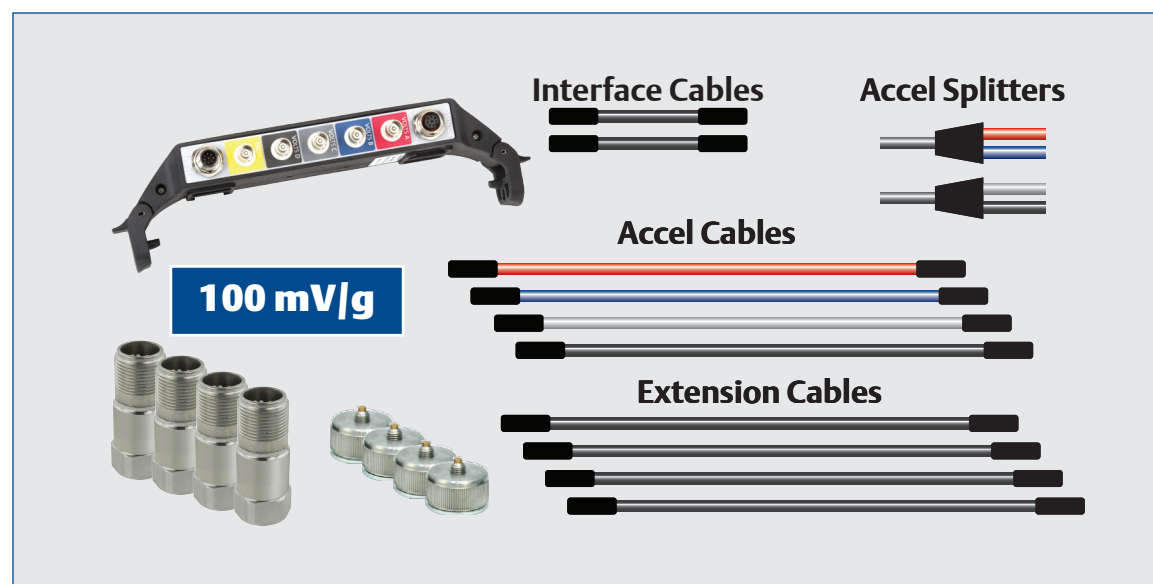

AMS 2140 Model String Options – Sensor Kits (Option “X”) Triax plus Standard Accel with Coiled Cable for Routine Data Collection

A21404CHACC-TU

Non-rated

Item	Description	Qty
A0643TX-EX	SAFETY RATED INTEGRAL MAGNET TRIAX ACCEL	1
D24826	MOUNTING PAD, TRIAX A0643TX	4
D25777	TRIAXIAL ACCEL CABLE, 5P M12 TO 5P 1/2IN-20UNF	1
A0760GP	ACCEL, 100MV/G \pm 5%, 0.5HZ-10KHZ, IP68, CE	1
A090835	MAGNET 2 POLE, 1IN CURVED SURFACE	1
D25782	CH A ACCEL COILED CABLE 5P M12 TO 2P MIL 6FT	1

A2140Q4CHACC-TU

Rated (For use with Option “KL” or “EX”)

Item	Description	Qty
A0643TX-EX	SAFETY RATED INTEGRAL MAGNET TRIAX ACCEL	1
D24826	MOUNTING PAD, TRIAX A0643TX	4
D25777	TRIAXIAL ACCEL CABLE, 5P M12 TO 5P 1/2IN-20UNF	1
A0760GP	ACCEL, 100MV/G \pm 5%, 0.5HZ-10KHZ, IP68, CE	1
A090835	MAGNET 2 POLE, 1IN CURVED SURFACE	1
D25782	CH A ACCEL COILED CABLE 5P M12 TO 2P MIL 6FT	1

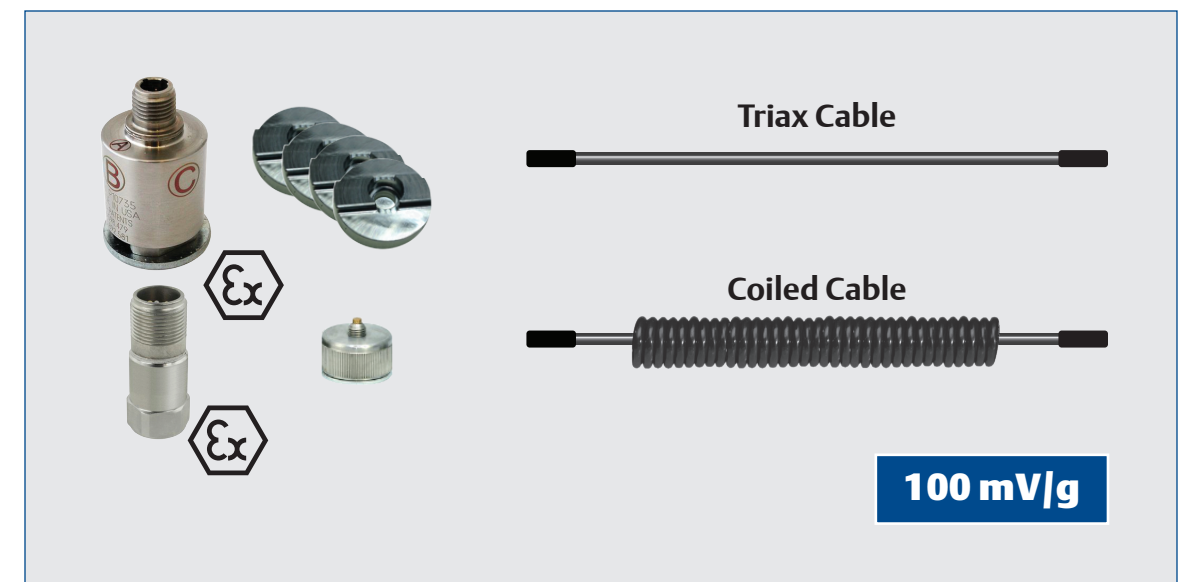
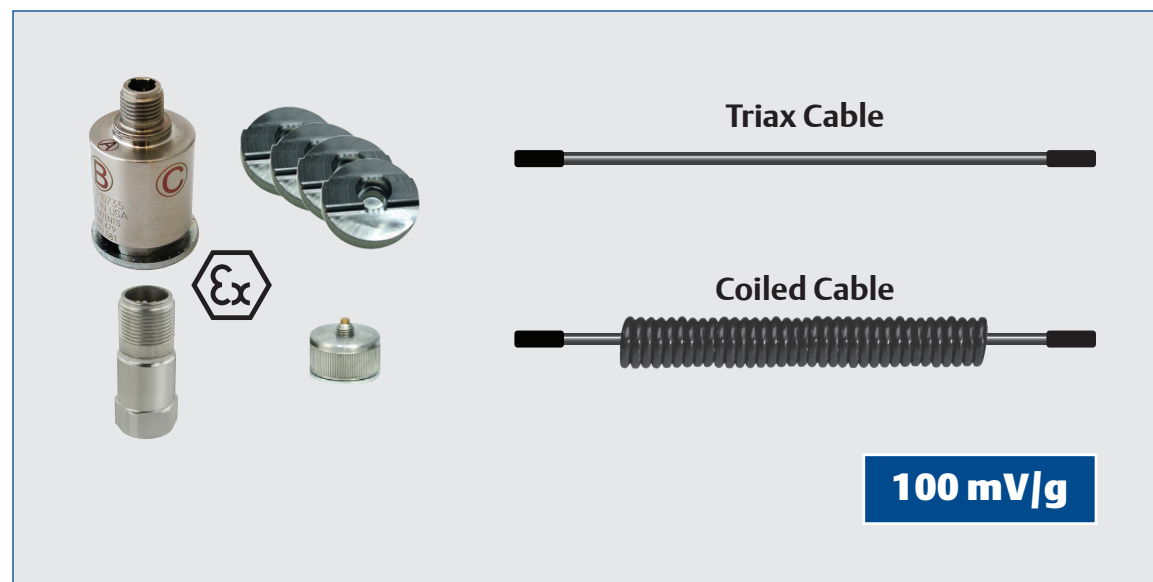

AMS 2140 Accessory Package – 2 Channel

A21402CHACC-TU

Non-rated

Item	Description	Qty
D25480	CH A ACCEL CABLE 5P M12 TO 2P MIL STRAIGHT 5FT RED	1
D25481	CH B ACCEL CABLE 5P M12 TO 2P MIL STRAIGHT 5FT BLUE	1
A0760GP	ACCEL, 100MV/G \pm 5%, 0.5HZ-10KHZ, IP68, CE	2
A090835	MAGNET 2 POLE, 1IN CURVED SURFACE	2
D25688	3 WAY SPLITTER CABLE 8P M12 TO BNC 0.2M RED, BLUE & TACH	1
D25782	CH A ACCEL COILED CABLE 5P M12 TO 2P MIL 6FT	1

A2140Q2CHACC-TU

Rated (For use with Option "KL" or "EX")

Item	Description	Qty
D25480	CH A ACCEL CABLE 5P M12 TO 2P MIL STRAIGHT 5FT RED	1
D25481	CH B ACCEL CABLE 5P M12 TO 2P MIL STRAIGHT 5FT BLUE	1
A0761GP-EX	IS ACCEL, 100MV/G \pm 5%, 0.5HZ-10KHZ, IP68, CE	2
A090835	MAGNET 2 POLE, 1IN CURVED SURFACE	2
D25782	CH A ACCEL COILED CABLE 5P M12 TO 2P MIL 6FT	1

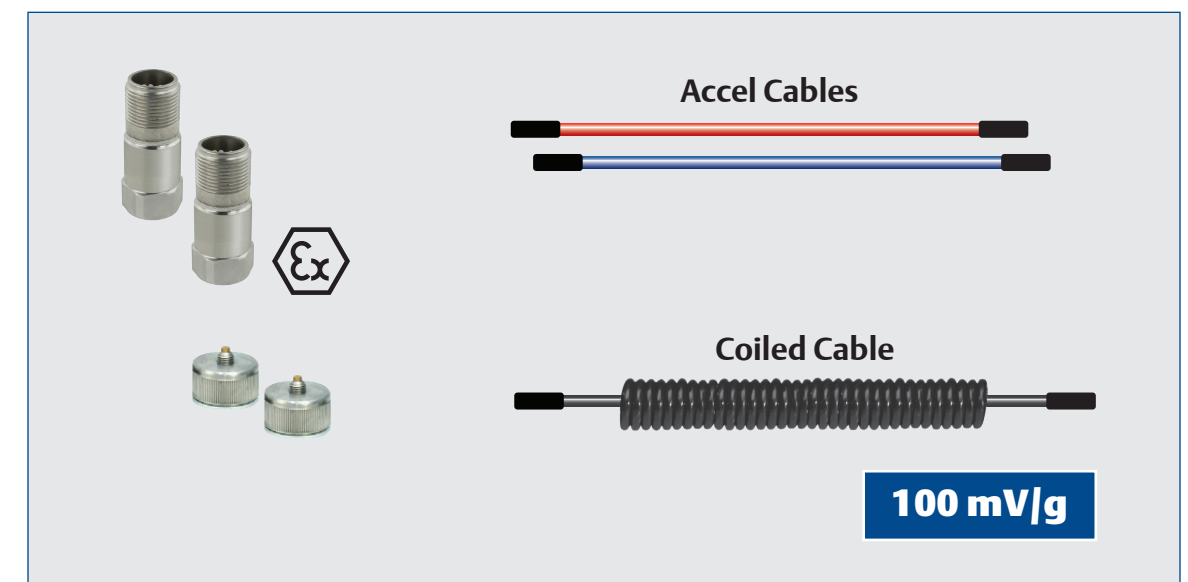
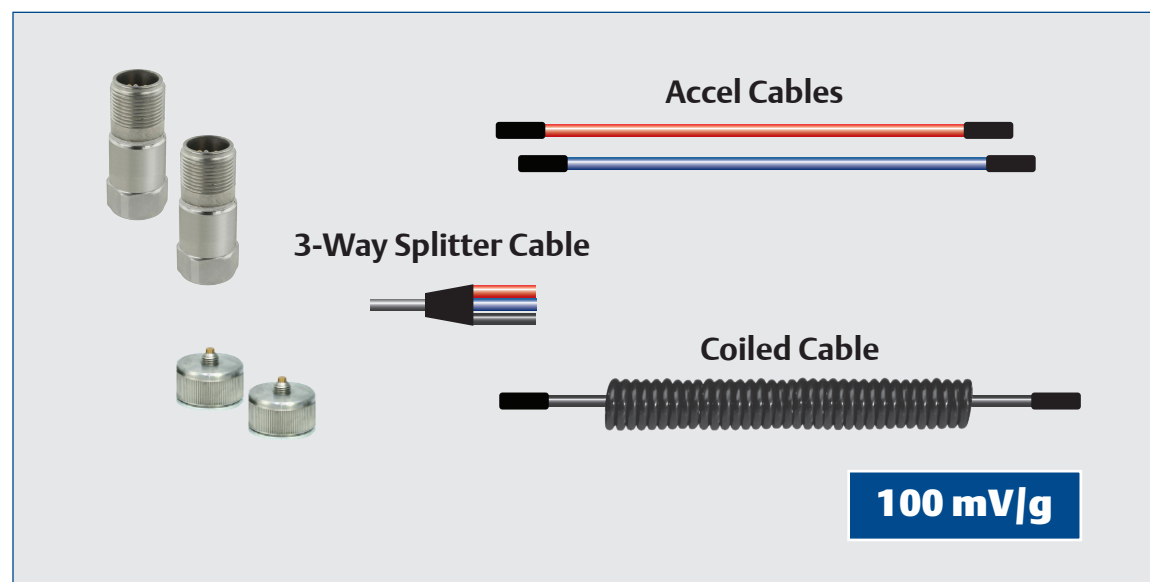

AMS 2140 Accessory Package – 1 Channel

A21401CHACC-TU

Non-rated

Item	Description	Qty
A0760GP	ACCEL, 100MV/G ±5%, 0.5HZ-10KHZ, IP68, CE	1
A090835	MAGNET 2 POLE, 1IN CURVED SURFACE	1
D25782	CH A ACCEL COILED CABLE 5P M12 TO 2P MIL 6FT	1

A2140Q1CHACC-TU

Rated (For use with Option "KL" or "EX")

Item	Description	Qty
A0761GP-EX	IS ACCEL, 100MV/G ±5%, 0.5HZ-10KHZ, IP68, CE	1
A090835	MAGNET 2 POLE, 1IN CURVED SURFACE	1
D25782	CH A ACCEL COILED CABLE 5P M12 TO 2P MIL 6FT	1

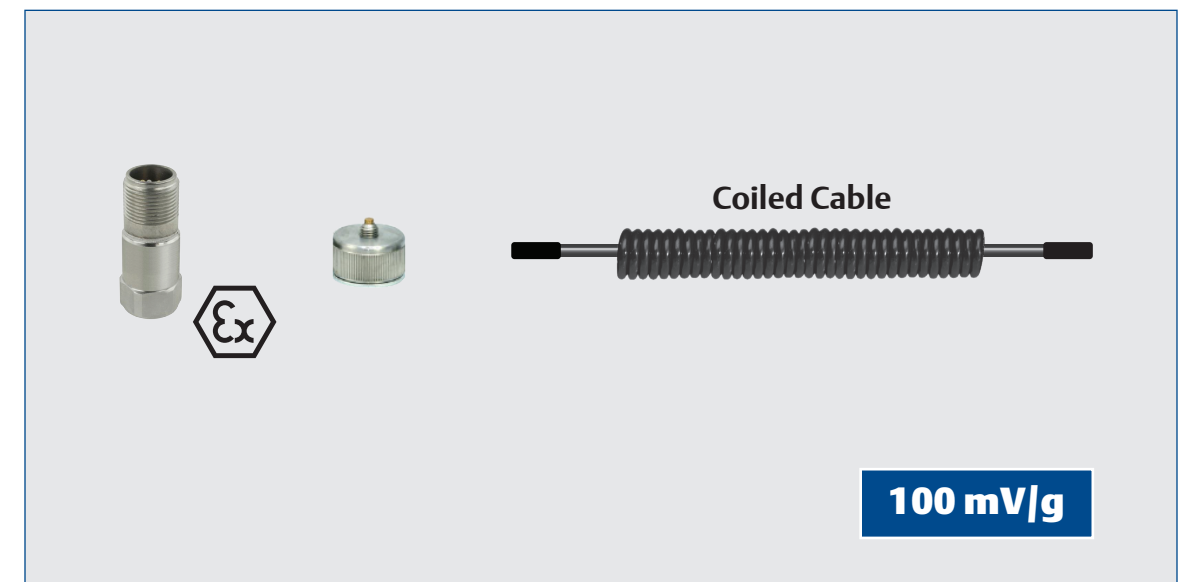
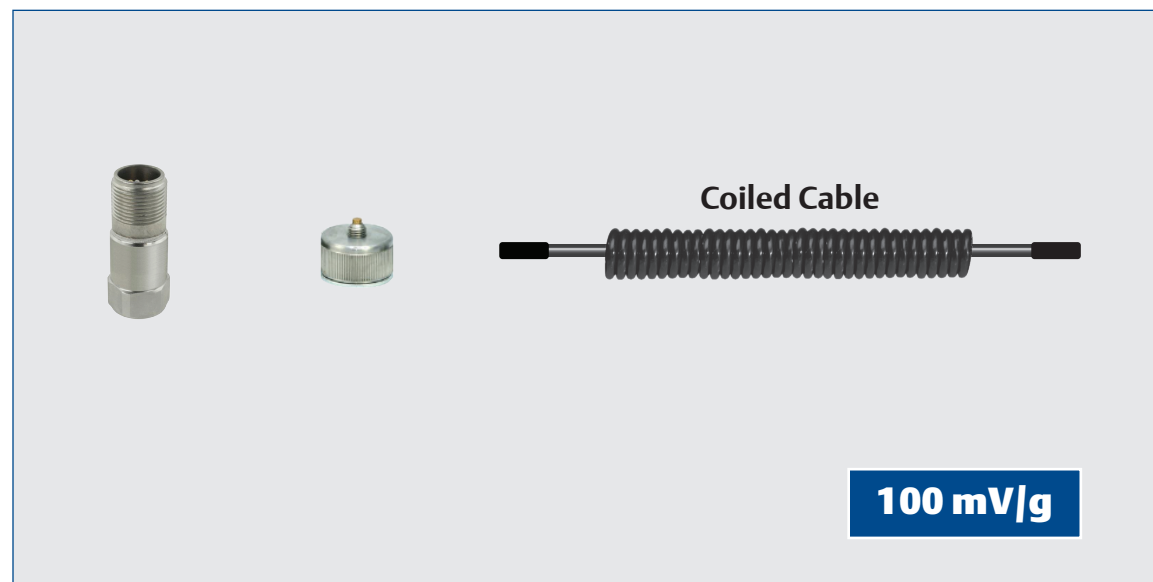

AMS 2140 Balancing Accessory Packages

B1740P1

AMS 2140 STANDARD BALANCING PACKAGE

Item	Description	Qty
A0760GP	ACCEL, 100MV/G \pm 5%, 0.5HZ-10KHZ, IP68, CE	2
D25485	CH A ACCEL CABLE 2P MIL TO BNC STRAIGHT 9FT RED	1
D25486	CH B ACCEL CABLE 2P MIL TO BNC STRAIGHT 9FT BLUE	1
A090835	MAGNET 2 POLE, 1IN CURVED SURFACE	2
B40405	404B PROBE	1
D25476	404 TACH CABLE 8P M12 TO AMP CONNECTOR 2M	1
B404-BASE	404 ADJUSTABLE MAGNETIC BASE	1
A403	403 TACHOMETER REFLECTIVE TAPE	1

B1740P2

AMS 2140 ADVANCED BALANCING PACKAGE

Item	Description	Qty
A0760GP	ACCEL, 100MV/G \pm 5%, 0.5HZ-10KHZ, IP68, CE	2
D25485	CH A ACCEL CABLE 2P MIL TO BNC STRAIGHT 9FT RED	1
D25486	CH B ACCEL CABLE 2P MIL TO BNC STRAIGHT 9FT BLUE	1
A090835	MAGNET 2 POLE, 1IN CURVED SURFACE	2
B40405	404B PROBE	1
D25472	TACH CABLE 8P M12 TO BNC 4FT BLACK	1
A040801	408 BATTERY PACK	1
B404-BASE	404 ADJUSTABLE MAGNETIC BASE	1
A403	403 TACHOMETER REFLECTIVE TAPE	2
A8BA1	BALANCING COMPASS	1
A650	ADAPTER, BNC BARREL, BNC (F) TO BNC (F)	1
D24786	1730 BALANCE KIT CASE	1
A40ADPTR	AMS 2140 4CH Input Adapter- 4-channel input adapter	1

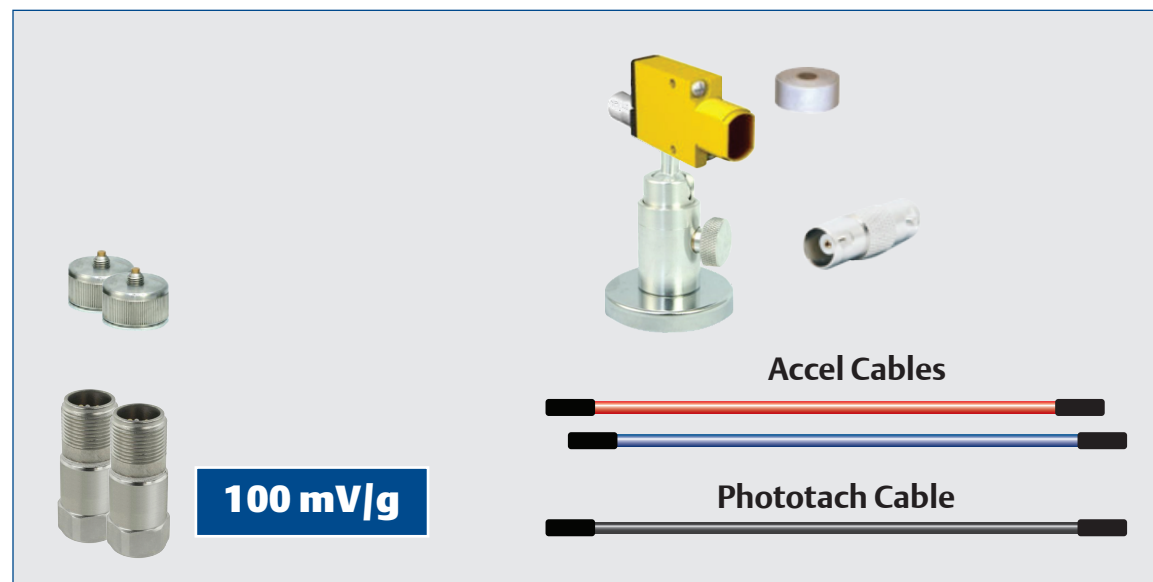

AMS 2140 Balancing Accessory Packages

A174001

2-4 SENSOR UPGRADE PACKAGE FOR AMS 2140 BALANCE PACKAGE

Item	Description	Qty
A0760GP	ACCEL, 100MV/G \pm 5%, 0.5HZ-10KHZ, IP68, CE	2
D25487	CH C ACCEL CABLE 2P MIL TO BNC STRAIGHT 9FT GREY	1
D25488	CH D ACCEL CABLE 2P MIL TO BNC STRAIGHT 9FT BLACK	1
MHM-65007-PBF	CABLE ASSEMBLY AMS 2140 VOLTS EXTENSION CABLE	1
A090835	MAGNET 2 POLE, 1IN CURVED SURFACE	2
A8BA25	BALANCE SCALES & TRIAL WGHT KIT	1
MHM-97546-PBF	Envelope Documentation 6in x 9in White Wove w/Graphics	1

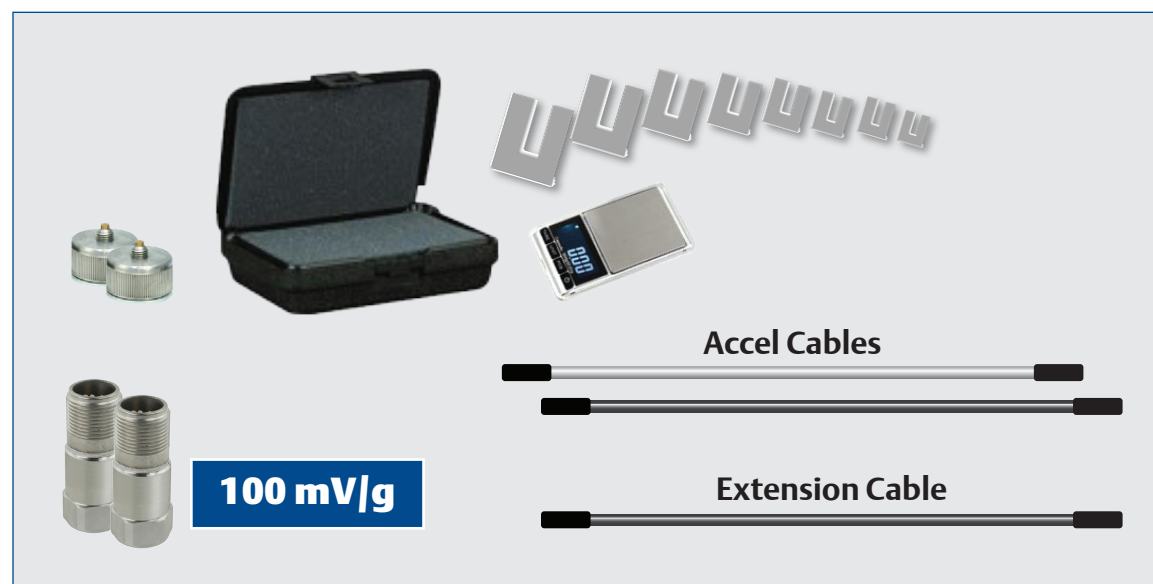
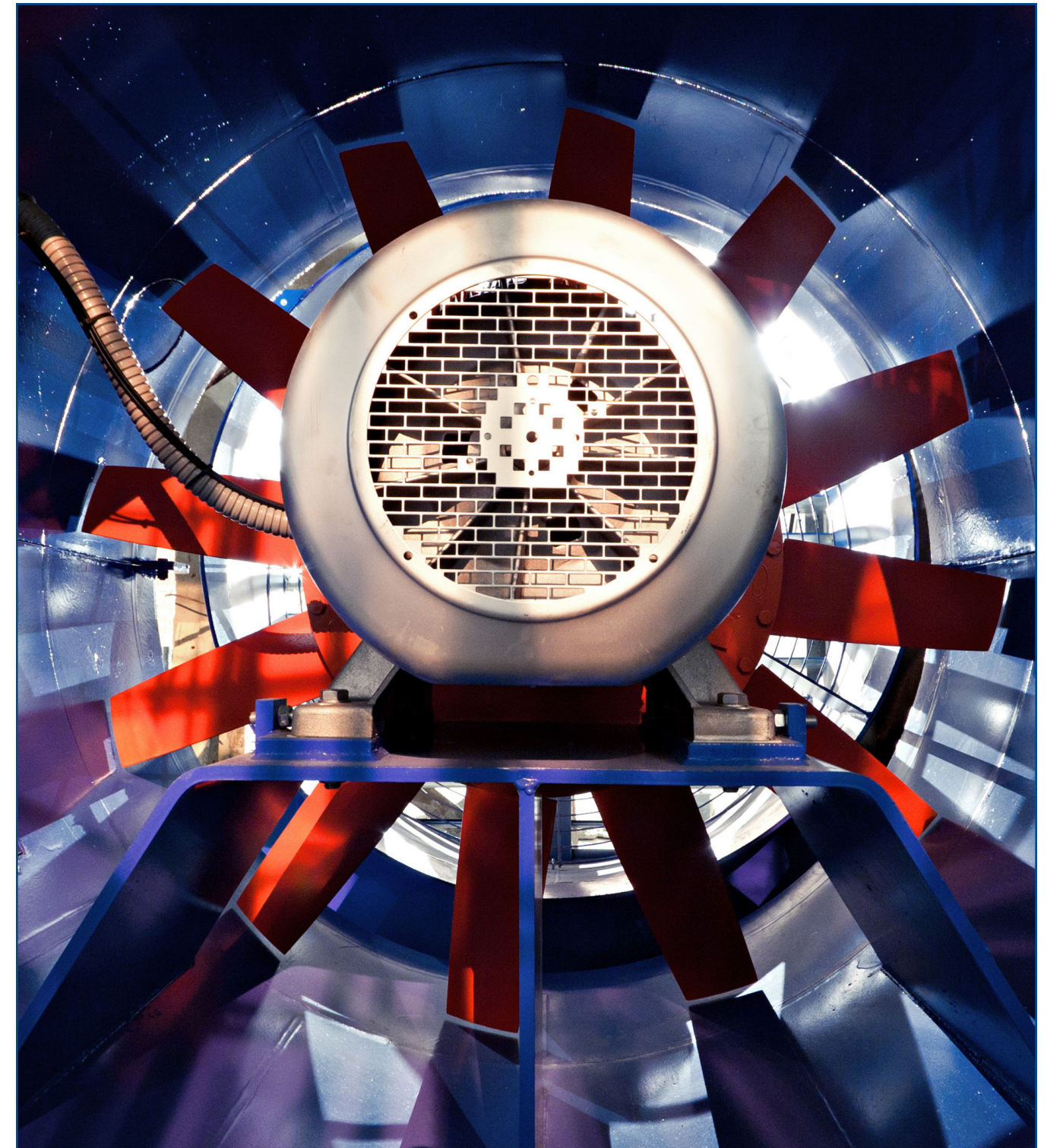



Power Source

MHM-93046-PBF
POWER SUPPLY, EXTERNAL,
DESKTOP UNIV AC LINE-IN,
15VDC@4A OUT, FERRITE CABLE

[NOTE: Add appropriate cord set
for end user location.]

Ethernet

USB 2.0

MHM-93368-PBF
USB 2.0 2 METERS USB STD-A
PLUG USB MICRO-B PLUG

**Wireless Ethernet to
AMS Machinery Manager**

Wireless-Ethernet

**Bluetooth to
Accessories**

A2140RF2
WIRELESS MODULE ENABLES
BLUETOOTH AND WIRELESS ETHERNET



A8240
LASER ALIGNMENT KIT
FOR AMS 2140



A647BT
BLUETOOTH HEADPHONES
FOR AMS 2140



377BT
BLUETOOTH TEMPERATURE GUN
(Order directly from Manufacturer
www.testproductsintl.com)

AMS 2140 – Small Accessory Items



A914 – ADAPTER 914 MOUNT STUD 10-32 TO 1/4-28
For use with magnets or sensors with removable mounting studs for converting to 10-32 threading



A915 – ADAPTER 915 MOUNT STUD 10-32 TO 10-32



A916 – ADAPTER. 916 MOUNT STUD 1/4-28 TO 1/4-28

MHM-62390-PBF – MOUNTING STUD, 1/2-20 UNF TO M8X1.0 THREAD

MHM-62392-PBF – MOUNTING STUD, 1/2-20 UNF TO M8X1.25 THREAD MOUNTING STUD, 1/2-20 UNF TO M8X1.25 THREAD FOR USE WITH THE A0394 SERIES OF SENSORS

MHM-62394-PBF – MOUNTING STUD, 1/2-20 UNF TO M6X1.0 THREAD

MHM-85493 – Mounting base, 1/2-20 UNF OD thds, integral 1/4-28 stud, tapped 1/8in hex hole (for A0394 and A0322 Series accels)

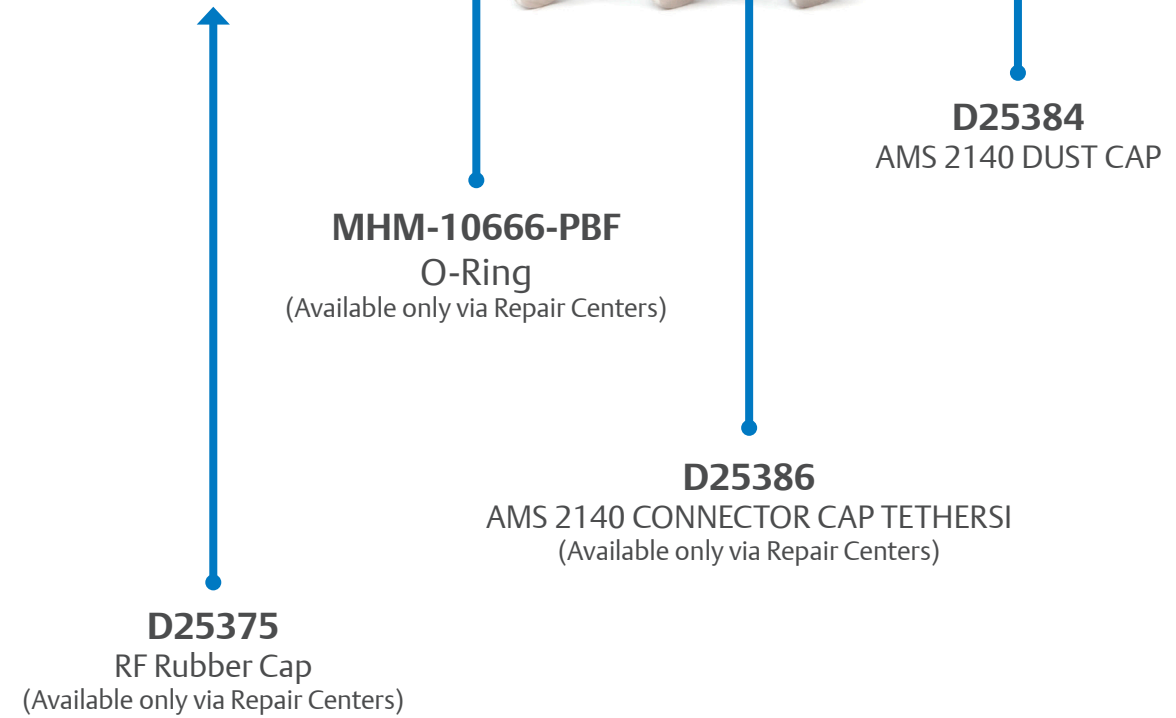

AMS 2140 Accessories – Sensors – Top Exit

Non-Safety Rated

A0760GP HIGH LINEAR FREQUENCY; ACCEL, 100MV/G ±5%, TOP C5015 CONN, 0.5HZ-10KHZ, IP68, CE



100 mV/g

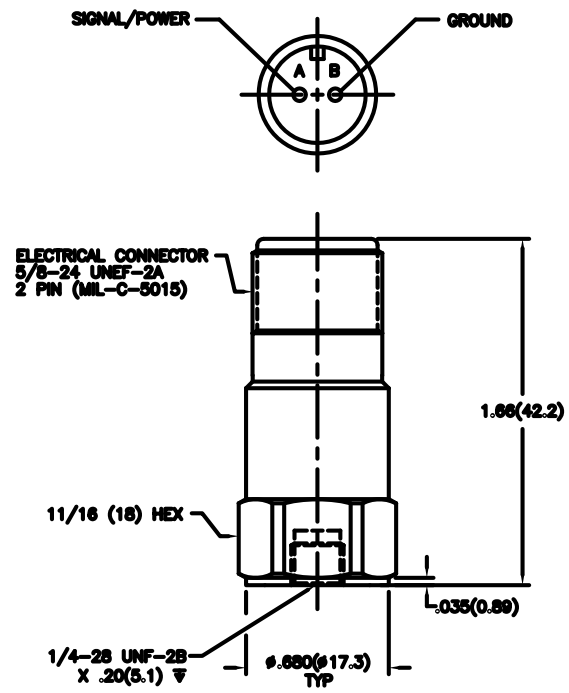

Safety Rated

A0761GP-EX MULTIPLE AGENCY APPROVALS; ACCEL, 100MV/G ±5%, TOP C5015 CONN, 0.5HZ-10KHZ, IP68, CE, CSA, ATEX



100 mV/g

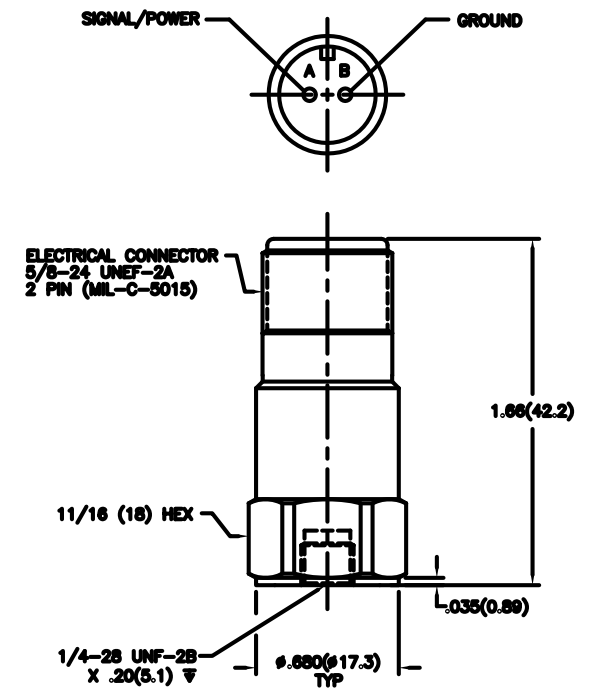

AMS 2140 Accessories – Sensors – Side Exit

Non-Safety Rated

A0710GP GENERAL PURPOSE; ACCEL, 100MV/G ±5%, SIDE C5015 CONN, 0.2HZ-10.5KHZ, IP68, CE

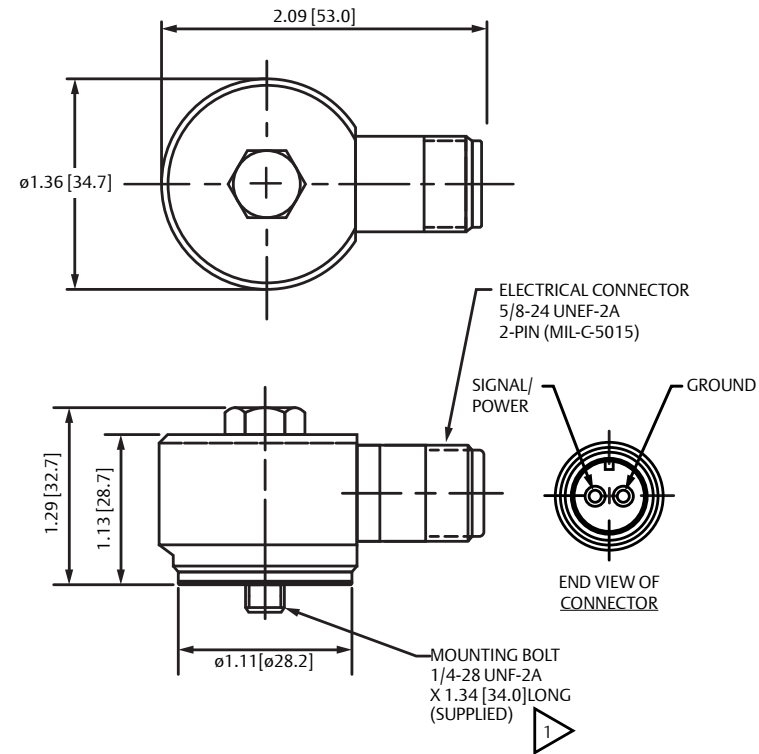

100 mV/g



Non-Safety Rated

A0322RM HIGH LINEAR FREQUENCY; ACCEL, 100MV/G ±5%, TOP C5015 CONN, 0.5HZ-10KHZ, IP68, CE

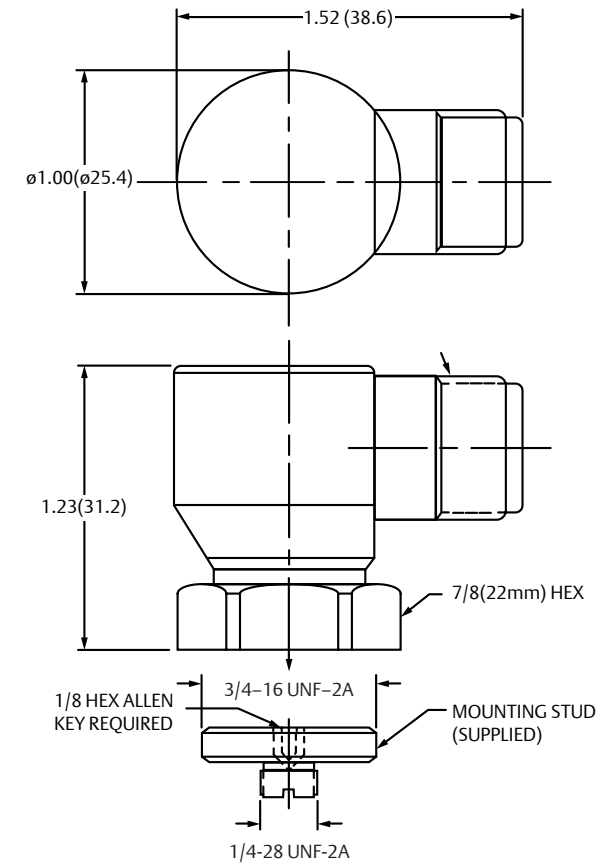

100 mV/g



A0322LC-NT QUICK RELEASE NUT & BASE, STAINLESS STEEL, 1/4-28

TOP EXIT – TRIAXIAL

A0643TX-EX SAFETY RATED INTEGRAL MAGNET TRIAXIAL ACCELEROMETER

This small, hazardous area rated for Class 1 Division 2 and ATEX/IECEx Zone 2 unique triaxial accelerometer attaches to the Model 2130 or AMS 2140 Machinery Health Analyzer by a single cable without the need for bulky adapters. It provides excellent measurements in all three axes using the integral magnet and the companion mounting pad (part#**D24826** – Details on next slide). Collected data provides information about traditional machine health parameters such as imbalance, misalignment, and bearing condition, but also helps detect insufficient lubrication. For standard applications, this sensor can also be used as a quality, single axis accelerometer without the need for a mounting pad



100 mV/g

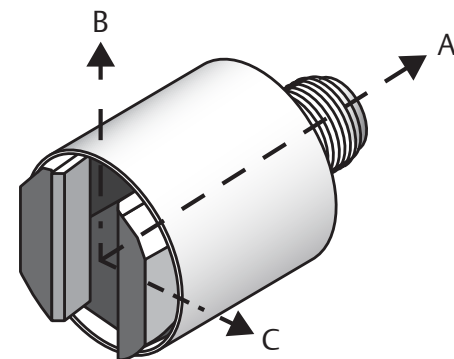

Directions in which each AMS 2140 channel collects data on the sensor.

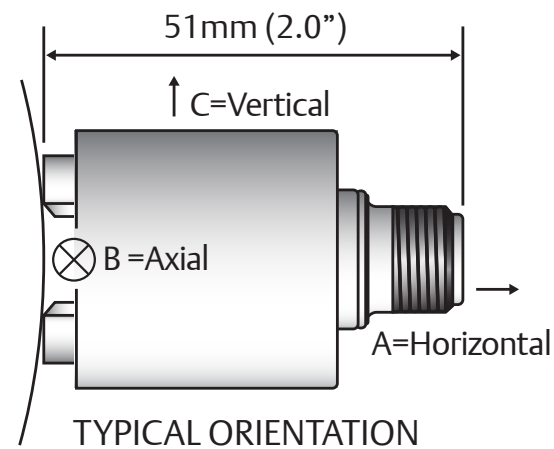

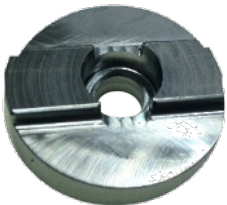
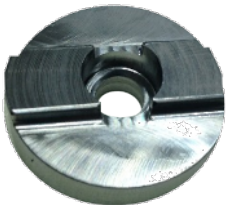

TRIAx

FEATURED ACCESSORY	PART #	DESCRIPTION
	D25777	TRIAxIAL ACCEL CABLE, FW STRAIGHT 5P M12 TO 5P 1/2IN-20UNF
	D24826	MOUNTING PAD, TRIAX A0643TX This mounting pad is keyed to ensure that the A0643TX sensor is oriented in the proper direction while providing superior measurement results. It can either be glued onto the machine or it can be installed via an allen screw after drilling and tapping the measurement point location
	A0643TX-200	KIT WITH 200 MOUNTING PADS FOR TRIAX A0643TX

AMS 2140 Accessories

FEATURED ACCESSORY	PART #	DESCRIPTION
	D25438	NECK STRAP ASSEMBLY
	A40SENHOLDR	STRAP MOUNTED DUAL ACCELEROMETER HOLDER FOR THE AMS 2140
	MHM-93046-PBF	POWER SUPPLY, EXTERNAL, DESKTOP UNIV AC LINE-IN, 15VDC@4A OUT, FERRITE CABLE
	A650100	US/CANADA AC POWER CABLE 3 COND. W/PLUG & RECT 125V
	B2140CORD-AU	AUSTRALIA AC POWER CORD 3 COND. W/PLUG & RECT 230V
	B2140CORD-EU	EU AC POWER CORD 3 COND. W/PLUG & RECT 230V
	B2140CORD-UK	UK AC POWER CORD 3 COND. W/PLUG & RECT 230V
	MHM-65142-C	ARGENTINA AC POWER CORD W/PLUG & RECT 230V
	MHM-65139-PBF	AUTOMOBILE 6' PWR CBL, PLUGS INTO CAR 12V ADAPTER The AMS 2140 car charger plugs into your car's 12 Volt DC adapter and allows you to charge the AMS 2140 battery safely while traveling from site to site.

FEATURED ACCESSORY	PART #	DESCRIPTION
	MHM-93368-PBF	USB 2.0 2 METERS USB STD-A PLUG USB MICRO-B PLUG
	D25384	REPLACEMENT DUST CAP
	A8BA1	ANGLE METER

AMS 2140 Accessories - Magnets

	A090515	MAGNET BASE 0.75IN 1/4-28 15LB PULL
	A090535	MAGNET BASE 1.00IN 1/4-28 35LB PULL
	A090550	MAGNET BASE 1.50IN 1/4-28 50LB PULL
	A090835	MAGNET BASE 1.00IN 1/4-28 35LB PULL, TWO POLE FOR USE ON CURVED SURFACES
	A904	MAGNET BASE 1.00IN 1/4-28 , FLAT RARE EARTH
	A918	MAGNETIC CABLE HOLDER

AMS 2140 Accessories – SpeedVue Laser Sensor

	A0430L4	Model 430 Laser Speed Sensor with AMS 2140 compatible M12-to-Lemo cable (D25473) in hard-shell carrying case.
	D25473 D25474 D25475	SPEEDVUE CABLE 8P M12 TO 4P LEMO 24IN SPEEDVUE CABLE 8P M12 TO 4P LEMO 42IN SPEEDVUE CABLE 8P M12 TO 4P LEMO 6FT
	A40SVMNT	MODEL 430 MOUNT FOR THE AMS 2140 MACHINERY HEALTH ANALYZER
	D24817	430LS PROTECTIVE LENS
	D24816	430LS BEAM ATTENUATOR (SpeedVue Cover)
	A0430MB	430LS MAGNETIC BASE
	A0430TR	430LS TRIPOD
	D24937	HAND STRAP PAD FOR SpeedVue

AMS 2140 Accessories – Phototach

A0404B40 - 404B TACHOMETER WITH CABLE (M12 CABLE TO AMPHENOL) FOR DIRECT CONNECTION TO AMS 2140. [NOTE: PHOTOTACH IS POWERED BY THE AMS 2140.]



THE 404B INFRARED PHOTOTACH IS A SELF-CONTAINED, REFLECTIVE SENSOR. IT PROVIDES DIRECT READINGS UP TO 20,000 RPM AT DISTANCES UP TO 3 FEET. DISTANCE MAY VARY WITH RPM

A0404B40

A0404P40 - 404B PHOTOTACH KIT WITH EXTERNAL POWER SUPPLY AND CABLE (M12 TO BNC) FOR CONNECTING TO AMS 2140



A0404P40

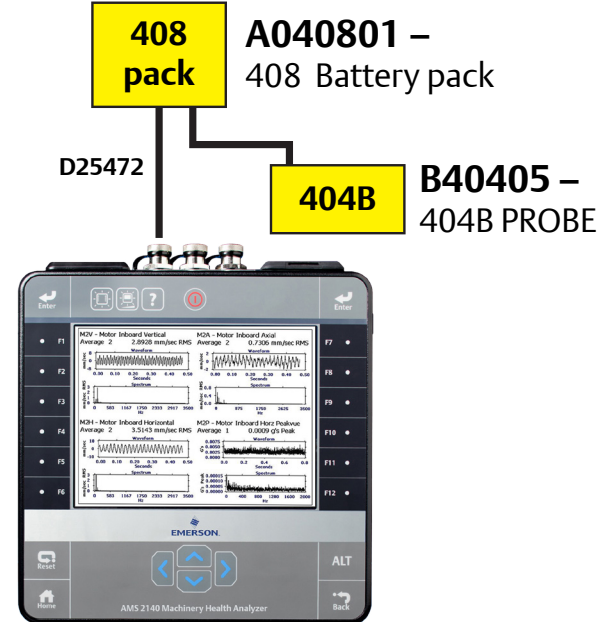

	B40405	404B PROBE
	A840	SUITCASE FOR PHOTOTACH (ALL MODELS)
	B404-BASE	404 ADJUSTABLE MAGNETIC BASE
	D10420	404 SENSOR HOLDER, ALUMINUM W/BRACKET, 2IN X 1IN
	D25476	404 TACH CABLE 8P-M12 TO AMP CONNECTOR 2M BLACK
	A403	403 TACHOMETER REFLECTIVE TAPE
	A040801	408 BATTERY PACK
	A0404P1	CABLE 404B POWER TACHOMETER W/TURCK & BNC
	D25472	TACH CABLE 8P M12 TO BNC 4FT BLACK

AMS 2140 Accessories – Strobelight



A0555-40

AMS VIBRATION STROBE LIGHT 115/230VAC WITH AMS 2140 CABLE

D25535

MODEL 555 STROBE TO AMS 2140 INTERFACE CABLE



B0555-BAT

555 STROBE REPLACEMENT BATTERY PACK NI-MH



AMS 9420 Wireless Vibration Transmitter

AMS 9420



BASE UNITS



B9420WA1J - Aluminum
AMS 9420 W/O LCD, 2.4 GHZ WIRELESSHART (CL I, DIV I/CL I, DIV II / ZONE 0 / ZONE 2)



B9420WA1LJ - Aluminum
AMS 9420 W/LCD, 2.4 GHZ WIRELESSHART (CL I, DIV I/CL I, DIV II / ZONE 0 / ZONE 2)



B9420WA1SSJ - Stainless Steel
AMS 9420 W/O LCD, 2.4 GHZ WIRELESSHART (CL I, DIV I/CL I, DIV II / ZONE 0 / ZONE 2)



B9420WA1LSSJ - Stainless Steel
AMS 9420 W/LCD, 2.4 GHZ WIRELESSHART (CL I, DIV I/CL I, DIV II / ZONE 0 / ZONE 2)



AMS 9420 – Power Options and Accessories

POWER OPTIONS



A0701PBU – EXTENDED LIFE SMART POWER MODULE

Specially designed for use with the AMS 9420, but may also be applicable for other Emerson transmitters. Refer to specific device information for details.

Intrinsically Safe for use with the AMS 9420 – may be changed out in the hazardous area.



A9000PA – POWER ADAPTER

Power adapter for *Wireless*HART transmitters enables device to be powered by 10-28V external DC line power. The adapter plugs into the same receptacle in place of the power module.



A9000PS-A – POWER/SIGNAL ADAPTER

Power and Signal adapter with 2 Accel inputs for the AMS 9420. Allows the device to be powered by 10-28V external DC power and accepts input signals from up to 2 standard 100 mV/g ICP accelerometers.



For use with 100 mV/g

ACCESSORIES

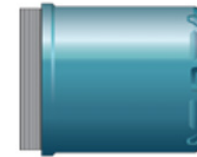

B9000AL – EXT ALUM END CAP FOR EXT LIFE POWER MODULE



B9000SS – EXT SS END CAP FOR EXT LIFE POWER MODULE



MHM-62398-PBF – CABLE GLAND, 1/2IN NPT (3.3-8.64 MM) SAFETY RATED



A9420WFM – AMS 9420 BRACKET FOR FIELD MOUNTING



MHM-99515 – AMS 9420 POWER INPUT SAFETY BARRIER FOR DIV 1/ZONE 0 APPLICATIONS



AMS 9420 – Low Power Sensors with Integral Cable (25 mV/g)

A0394RI	– SPECIAL ORDER ACCEL, LOW PWR, RT ANG GREEN JKT, 10FT CBL, DIV 1/ZONE 0
A0394RI-1	– ACCEL, LOW PWR, RT ANG GREEN JKT, 30FT CBL, DIV 1/ZONE 0
A0394RI-4	– SPECIAL ORDER ACCEL, LOW PWR, RT ANG GREEN JKT, 95FT CBL, DIV 1/ZONE 0
2A0394RA	– SPECIAL ORDER ACCEL, LOW PWR, RT ANG GREEN JKT, 10FT ARM CBL, DIV 1/ZONE 0
A0394RA-1	– ACCEL, LOW PWR, RT ANG GREEN JKT, 30FT ARM CBL, DIV 1/ZONE 0
A0394RA-4	– SPECIAL ORDER ACCEL, LOW PWR, RT ANG GREEN JKT, 95FT CBL W/75FT ARM, DIV 1/ZONE 0
A0394RAC	– SPECIAL ORDER ACCEL, LOW PWR, RT ANG GREEN JKT, 10FT ARM CBL W/PTFE, DIV 1/ZONE 0
A0394RAC-1	– ACCEL, LOW PWR, RT ANG GREEN JKT, 30FT ARM CBL W/PTFE, DIV 1/ZONE 0
A0394RAC-4	– ACCEL, LOW PWR, RT ANG GREEN JKT, 30FT ARM CBL W/PTFE, DIV 1/ZONE 0
A0394DI	– SPECIAL ORDER ACCEL W/TEMP, LOW PWR, RT ANG BLUE JKT, 10FT CBL, DIV 1/ZONE 0
A0394DI-1	– ACCEL W/TEMP, LOW PWR, RT ANG BLUE JKT, 30FT CBL, DIV 1/ZONE 0
A0394DI-4	– SPECIAL ORDER ACCEL W/TEMP, LOW PWR, RT ANG BLUE JKT, 95FT CBL, DIV 1/ZONE 0
A0394DA	– SPECIAL ORDER ACCEL W/TEMP, LOW PWR, RT ANG, 10FT ARM CBL, DIV 1/ZONE 0
A0394DA-1	– ACCEL W/TEMP, LOW PWR, RT ANG, 30FT ARM CBL, DIV 1/ZONE 0
A0394DA-4	– SPECIAL ORDER ACCEL W/TEMP, LOW PWR, RT ANG, 95FT CBL W/75FT ARM, DIV 1/ZONE 0
A0394DAC	– AL ORDER ACCEL W/TEMP, LOW PWR, RT ANG, 10FT ARM CBL W/PTFE, DIV 1/ZONE 0
A0394DAC-1	– ACCEL W/TEMP, LOW PWR, RT ANG, 30FT ARM CBL W/PTFE, DIV 1/ZONE 0
A0394DAC-4	– SPECIAL ORDER ACCEL W/TEMP, LOW PWR, RT ANG, 95FT CBL W/PTFE AND 75FT ARM, DIV 1/ZONE 0
A0394LC	– LOW COST ACCEL, LOW PWR, TOP EXIT GREEN JKT, 10FT CBL, DIV 1/ZONE 0

**** MHM-85493 **** – Mounting Base 1/2-20 UNF OD thds, integral 1/4-28 stud, tapped 1/8in hex hole (for A0394 and A0322 Series accels)



25 mV/g

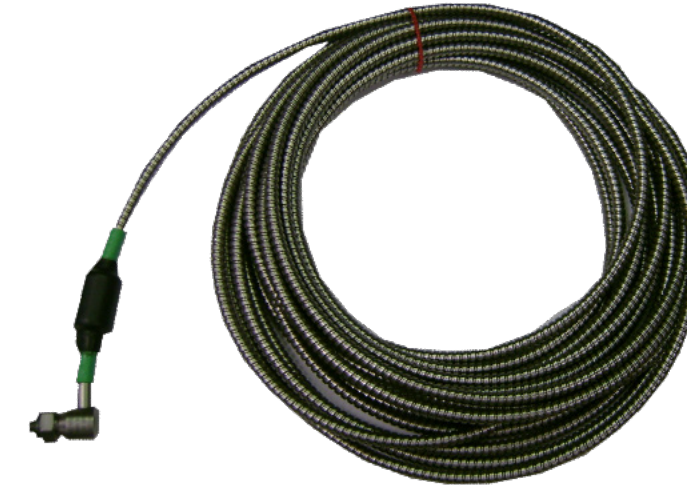

A0394RA-1
ACCEL, LOW PWR, RIGHT ANGLE GREEN JACKET,
30FT ARMORED CABLE, DIV 1/ZONE 0

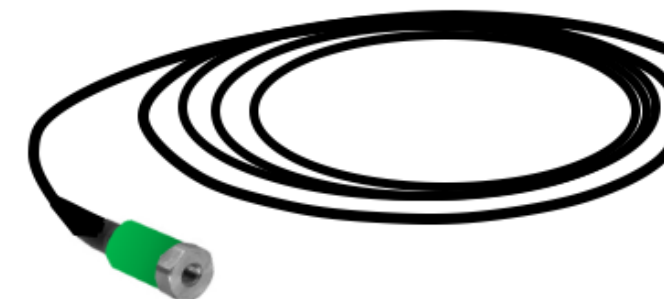

A0394LC
LOW COST ACCEL, LOW PWR, TOP EXIT GREEN JKT,
10FT CABLE, DIV 1/ZONE 0

AMS 6500 ATG Protection System

AMS 6500 ATG Form Factors



Standard Rack A6500-SR

- 3U height (one rack) / 6U (two racks)
- 19 inch wide (84 HP)
- 240mm depth (+100mm installation space)
- Rear termination
- Each rack chassis (3U) for:
 - Up to two communication cards (A6500-CC)
 - One single relay card (A6500-RC)
 - Up to 11 UM or TP cards (A6500-UM and/or A6500-TP)

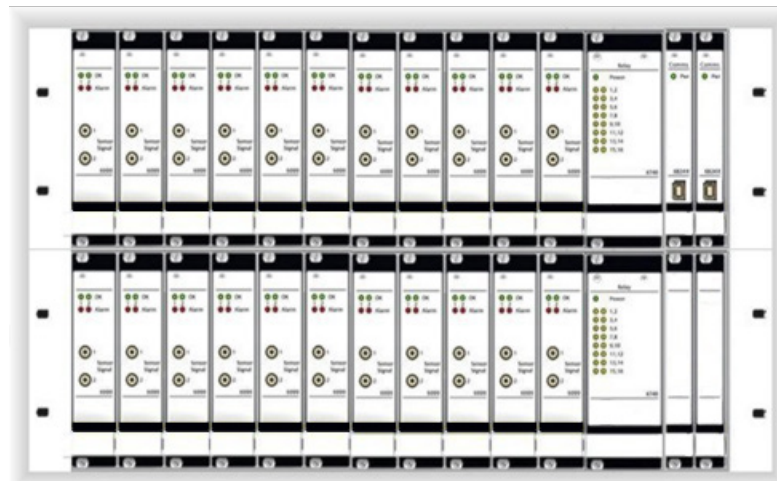

Redundant Relay Rack A6500-RR

- 3U height (one rack) / 6U (two racks)
- 19 inch wide (84 HP)
- 240mm depth (+100mm installation space)
- Rear termination
- Each rack chassis (3U) for:
 - Up to two communication cards (A6500-CC)
 - Up to two relay cards (A6500-RC)
 - Up to 9 UM or TP cards (A6500-UM and/or A6500-TP)





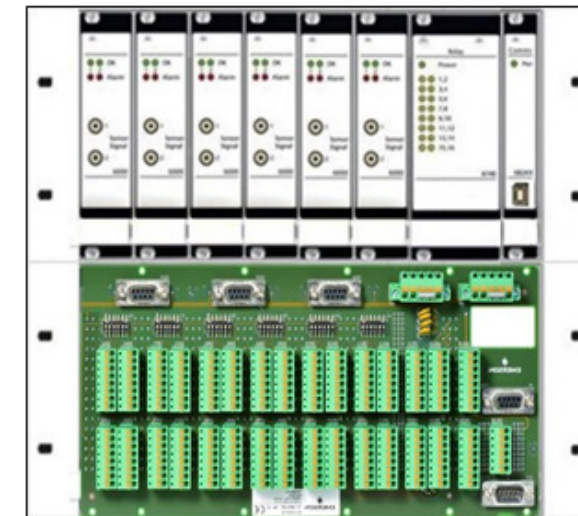

Front Termination Rack A6500-FR

- 6U height
- 12.25 inch wide (50HP)
- 240mm depth
- Front termination
- Compact rack chassis for:
 - One communication card (A6500-CC)
 - One single relay card (A6500-RC)
 - Up to 6 UM or TP cards (A6500-UM and/or A6500-TP)



A6910 Configuration Kit

Bill of Material

Quantity	Model Number	Product Description	
1	MHM-6XXX-CONFIGCABLE	AMS 6500 & AMS 6300 SIS V1 CONFIGURATION CABLE <i>Approx. 2m cable length, Sub-D 9 pole (female) connection (PC) and PS2 connection (Card)</i>	
1	MHM-6XXX-USB-CABLE	AMS 6500 ATG & AMS 6300 SIS V2 CONFIGURATION CABLE <i>Approx. 1m cable length, USB-A connection (PC) and USB-B connection (Card)</i>	
1	MHM-6XXX-USB-ADTR	RS232 TO USB-A ADAPTER (USB 2.0), INCL. 0.7M CABLE <i>Spectra 112315 USB to RS-232 converter, Length of included USB connection cable approx. 0.7m, Sub-D 9 pole (male) and USB 2.0 (compatible to USB 1.1) connection, up to 115.2kbps baud rate, driver for Windows XP & Windows 7 (32- & 64Bit)</i>	
2	MHM-6XXX-SMBCABLE	SMB SIGNAL OUTPUT CABLE <i>Approx. 3m cable length, Subcllc SMB connection (both sides)</i>	
2	MHM-6XXX-SMBADTR	SMB TO BNC ADAPTER <i>Approx. 30mm length, Subcllc SMB connection (Input) and BNC connection (Output)</i>	
1	Documentation CD	Product Manuals	

AMS 6500 Machinery Health Monitor Prediction System

AMS 6500



RACK VERSIONS

ALL RACKS INCLUDE PEAKVUE AND MODBUS



- A6500MS-12** MONITOR
12 ANALOG, 2 TACHOMETER & 2 RELAY CHANNELS
- A6500MS-24** MONITOR
24 ANALOG, 4 TACHOMETER & 4 RELAY CHANNELS
- A6500TS-12** TRANSIENT
12 ANALOG, 2 TACHOMETER & 2 RELAY CHANNELS
- A6500TS-24** TRANSIENT
24 ANALOG, 4 TACHOMETER & 4 RELAY CHANNELS



WALL MOUNT CABINETS

RACKS ASSEMBLED WITH CABINET IF PURCHASED AT THE SAME TIME



- A6500MS-24-ENCL-IC** WALL MOUNT CABINET
12 or 24 CHANNEL RACK
24" TALL x 16" WIDE x 12" DEEP

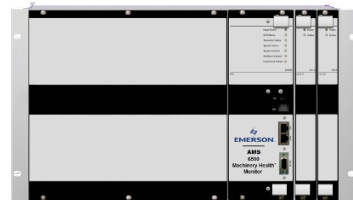

- A6500MR-12** MONITOR
12 ANALOG, 2 TACHOMETER & 2 RELAY CHANNELS
- A6500MR-24** MONITOR
24 ANALOG, 4 TACHOMETER & 4 RELAY CHANNELS
- A6500TR-12** TRANSIENT
12 ANALOG, 2 TACHOMETER & 2 RELAY CHANNELS
- A6500TR-24** TRANSIENT
24 ANALOG, 4 TACHOMETER & 4 RELAY CHANNELS



- A6500PRE-SS-WM-24-IC** WALL MOUNT CABINET
12 or 24 CHANNEL RACK
36" TALL x 24" WIDE x 12" DEEP

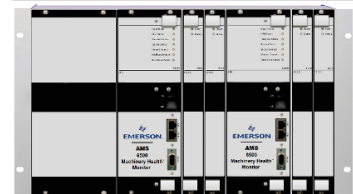

- A6500MR-36** MONITOR
36 ANALOG, 6 TACHOMETER & 6 RELAY CHANNELS
- A6500MR-48** MONITOR
48 ANALOG, 8 TACHOMETER & 8 RELAY CHANNELS
- A6500TR-36** TRANSIENT
36 ANALOG, 6 TACHOMETER & 6 RELAY CHANNELS
- A6500TR-48** TRANSIENT
48 ANALOG, 8 TACHOMETER & 8 RELAY CHANNELS



- A6500PRE-SS-WM-48-IC** WALL MOUNT CABINET
36 or 48 CHANNEL RACK
36" TALL x 24" WIDE x 12" DEEP

AMS 2600 – portable AMS 6500

VERSIONS

ALL AMS 2600 SYSTEMS INCLUDE PEAKVUE AND MODBUS

A2600M7 MONITOR

12 ANALOG, 2 TACHOMETER & 2 RELAY CHANNELS

A2600M8 MONITOR

24 ANALOG, 4 TACHOMETER & 4 RELAY CHANNELS

A2600T7 TRANSIENT

12 ANALOG, 2 TACHOMETER & 2 RELAY CHANNELS

A2600T8 TRANSIENT

24 ANALOG, 4 TACHOMETER & 4 RELAY CHANNELS



AMS 2600 PORTABLE

12 or 24 CHANNEL RACK

20.25" TALL x 8.25" WIDE x 16" DEEP

30 lb

A0322 – Accelerometers with Integral Cable

STANDARD, TOP EXIT (2 WIRE)

A0322LC	ACCEL 100MV/G ±10% TOP EXIT 10' CABLE 0.5HZ-10KHZ IP68
A0322LC-1	ACCEL 100MV/G ±10% TOP EXIT 30' CABLE 0.5HZ-10KHZ IP68
A0322LC-2	ACCEL 100MV/G ±10% TOP EXIT 50' CABLE 0.5HZ-10KHZ IP68

AGENCY RATED, TOP EXIT (2 WIRE)

A0322LC-EX	ACCEL 100MV/G ±10% TOP EXIT 10' CABLE 0.5HZ-10KHZ IP68 ATEX
A0322LC-1-EX	ACCEL 100MV/G ±10% TOP EXIT 30' CABLE 0.5HZ-10KHZ IP68 ATEX

WITH TEMPERATURE OUTPUT (3 WIRE)

A0322DS	ACCEL/TEMP 100MV/G ±10% TOP EXIT 10' CABLE 0.5HZ-10KHZ IP68 CE
A0322DS-1	ACCEL/TEMP 100MV/G ±10% TOP EXIT 30' CABLE 0.5HZ-10KHZ IP68 CE

STANDARD, SWIVELER, SIDE EXIT (2 WIRE)

A0322RI	ACCEL 100MV/G ±10% SIDE EXIT SWIVEL 10' CABLE 0.43HZ-10KHZ IP68 CE
A0322RI-1	ACCEL 100MV/G ±10% SIDE EXIT SWIVEL 30' CABLE 0.43HZ-10KHZ IP68 CE
A0394RI-2	ACCEL 100MV/G ±10% SIDE EXIT SWIVEL 50' CABLE 0.43HZ-10KHZ IP68 CE

ARMORED CABLE, SWIVELER, SIDE EXIT (2 WIRE)

A0322RA	ACCEL 100MV/G ±10% SIDE EXIT SWIVEL 10' ARMOR CBL 0.43-10KHZ IP68 CE
A0322RA-1	ACCEL 100MV/G ±10% SIDE EXIT SWIVEL 30' ARMOR CBL 0.43-10KHZ IP68 CE
A0322RA-2	ACCEL 100MV/G ±10% SIDE EXIT SWIVEL 50' ARMOR CBL 0.43-10KHZ IP68 CE

AGENCY RATED, ARMORED, SWIVELER, SIDE EXIT (2 WIRE)

A0322RA-EX	ACCEL 100MV/G ±10% SIDE EX SWIVEL 10' ARMOR CBL .43-10K IP68 CE ATEX
A0322RA-1-EX	ACCEL 100MV/G ±10% SIDE EX SWIVEL 30' ARMOR CBL 0.43-10K IP68 CE ATEX

WITH TEMPERATURE OUTPUT, SWIVELER, SIDE EXIT (3 WIRE)

A0322DR	ACCEL/TEMP 100MV/G ±10% SIDE EXIT SWIVEL 10' CABLE 0.5HZ-10K IP68 CE
A0322DR-1	ACCEL/TEMP 100MV/G ±10% SIDE EXIT SWIVEL 30' CABLE 0.5HZ-10K IP68 CE



EMERSON ACCELEROMETER ADVANTAGES

1. PEAKVUE TUNED; BEST PEAKVUE READINGS
2. CALIBRATION WITH EACH SENSOR
3. 10% SENSITIVITY UNCERTAINTY
4. ONE SOURCE RESPONSIBILITY FOR EVERYTHING

A0322 – Accelerometers with Connectors

STANDARD, TOP EXIT (2 PIN)

A0322L5 ACCEL 100MV/G ±10% TOP EXIT C5015 CONNECTOR 0.5HZ-10KHZ IP68 CE

AGENCY RATED, TOP EXIT (2 PIN)

A0322L5-EX ACCEL 100MV/G ±10% TOP EXIT C5015 CONN 0.5HZ-10KHZ IP68 CE CSA ATEX



EMERSON ACCELEROMETER ADVANTAGES

1. PEAKVUE TUNED; BEST PEAKVUE READINGS
2. CALIBRATION WITH EACH SENSOR
3. 10% SENSITIVITY UNCERTAINTY
4. ONE SOURCE RESPONSIBILITY FOR EVERYTHING

STANDARD, SIDE EXIT (2 PIN)

A0322R5 ACCEL 100MV/G ±10% SIDE EXIT SWIVEL 10' CABLE 0.43HZ-10KHZ IP68 CE

HIGH TEMPERATURE, SIDE EXIT (2 PIN)

A0322R5-HT ACCEL 100MV/G ±10% SIDE EXIT SWIVEL 10' CABLE 0.43HZ-10KHZ IP68 CE



THERMO SHOCK COMPETENT, SIDE EXIT (2 PIN) (NOTE: NOT PEAKVUE TUNED)

A0322RTS ACCEL 100MV/G ±10% SIDE EXIT SWIVEL 10' CABLE 0.43HZ-10KHZ IP68 CE

STANDARD, SWIVELER, SIDE EXIT (2 WIRE)

A0322RM ACCEL 100MV/G ±10% SIDE EXIT SWIVEL 10' ARMOR CBL 0.43-10KHZ IP68 CE

NO PICTURE

THIS SENSOR CAN WITHSTAND COLD WATER WASHUPS WITHOUT CRACKING



Other Sensors and Cables for Sensors with Connectors

DYNAMIC PRESSURE SENSOR, TOP EXIT (2 PIN)

A0730DP DYNAMIC PRESS 100MV/PSI ±15% TOP C5015 CONN 0.5HZ-60KHZ IP68



TACHOMETER, PASSIVE MAGNETIC (2 PIN)

V425 PASSIVE MAGNETIC WITH BRACKET & 2 PIN C5015 CONNECTOR



STANDARD CABLE WITH C5015 BOOT CONNECTOR, (2 PIN)

- A612-NA-09-0** SENSOR CABLE, C5015 2Pin PUSH ON BOOT, NO ARMOR, 9M/30' LONG, BLUNT CUT
- A612-NA-18-0** SENSOR CABLE, C5015 2Pin PUSH ON BOOT, NO ARMOR, 18M/60' LONG, BLUNT CUT
- A612-NA-30-0** SENSOR CABLE, C5015 2Pin PUSH ON BOOT, NO ARMOR, 30M/100' LONG, BLUNT CUT



BNC CONNECTOR, STANDARD CABLE WITH C5015 BOOT CONNECTOR, (2 PIN)

- A612-NA-09-B** SENSOR CABLE, C5015 2Pin PUSH ON BOOT, NO ARMOR, 9M/30' LONG, MALE BNC
- A612-NA-18-B** SENSOR CABLE, C5015 2Pin PUSH ON BOOT, NO ARMOR, 18M/60' LONG, MALE BNC
- A612-NA-30-B** SENSOR CABLE, C5015 2Pin PUSH ON BOOT, 9M/30' ARMOR, 30M/100' LONG, BLUNT CUT

NO PICTURE
THESE CABLES WILL CONNECT DIRECTLY TO AN AMS 2600

ARMORED CABLE WITH C5015 BOOT CONNECTOR, (2 PIN)

- A612-AR-09-0** SENSOR CABLE, C5015 2Pin PUSH ON BOOT, ARMOR 9M/30' LONG, BLUNT CUT
- A612-AR-18-0** SOR CABLE, C5015 2Pin PUSH ON BOOT, 9M/30' ARMOR, 18M/60' LONG, BLUNT CUT
- A612-AR-30-0** SENSOR CABLE, C5015 2Pin PUSH ON BOOT, NO ARMOR, 30M/100' LONG, BLUNT CUT

NO PICTURE
THESE CABLES HAVE A MAXIMUM OF 30' OF ARMOR

AMS Trex Device Communicator

AMS Trex Power Accessories



Rechargeable Li-Ion Power Module

- TREN-0002-1211
- TREN-0002-3611 (with 3 years premium coverage)



DC Adapter (12v vehicle accessory outlet)

- TREN-0003-0022



AC Adapter (includes US, EU, UK, AU outlet plugs)

- TREN-0003-0012



AC Outlet Plugs (replacement set includes US, EU, UK, AU)

- TREN-0003-0004



AMS Trex Communication Module

Device Communicator Communication Module

- TREX-PMDC-1211
- All spare parts with 3 years of premium support (Communication Modules and Power Supply) are no longer available for purchase. Customers are encouraged to purchase AMS Trex Premium Support for the entire unit to receive one FREE repair per calendar year if needed.



Device Communicator Plus Communication Module

- TREX-PMDP-1211
- All spare parts with 3 years of premium support (Communication Modules and Power Supply) are no longer available for purchase. Customers are encouraged to purchase AMS Trex Premium Support for the entire unit to receive one FREE repair per calendar year if needed.

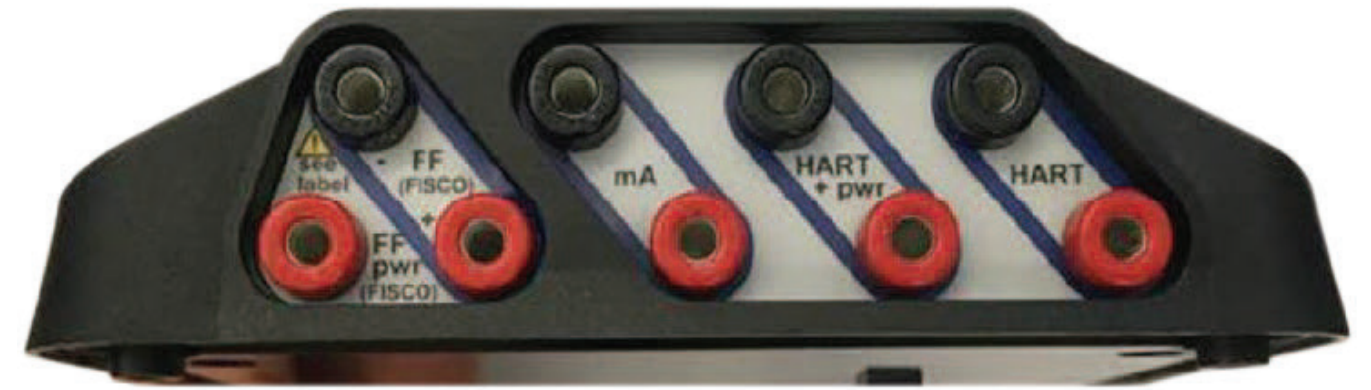

FOUNDATION Fieldbus Power Plus

■ TRENK-FFPA-0001



Lead Set with connectors

■ TRENK-0004-0001



Hand Strap (replacement set of 2)

■ TRENK-0005-0002



Carrying Case (includes hand & shoulder straps)

■ TRENK-0005-0011



Shoulder Strap (replacement for use with carrying case)

■ TREX-0005-0009



Magnetic Hanger

■ TREX-0005-0004



USB cable (USB to micro USB)

■ TREX-0004-0002



Stand (replacement integral to communication module)

■ TREX-0012-0011



AMS

Contact Us

 www.emerson.com/contactus

© 2025, Emerson. All rights reserved.

The Emerson logo is a trademark and service mark of Emerson Electric Co. The AMS logo is a mark of one of the Emerson family of companies. All other marks are the property of their respective owners.

The contents of this publication are presented for information purposes only, and while diligent efforts were made to ensure their accuracy, they are not to be construed as warranties or guarantees, express or implied, regarding the products or services described herein or their use or applicability. All sales are governed by our terms and conditions, which are available on request. We reserve the right to modify or improve the designs or specifications of our products at any time without notice.

