

# Rosemount™ 3408 Level Transmitter

## LCD Display Kit



# 1 About this guide

This guide provides instructions for retrofitting and replacing the LCD display on the Rosemount 3408 Level Transmitter. Refer to the Rosemount 3408 [Reference Manual](#) for instructions on how to set up the LCD display.

## 1.1 Safety messages

### **⚠ WARNING**

**Failure to follow safe installation and servicing guidelines could result in death or serious injury.**

Ensure the transmitter is installed by qualified personnel and in accordance with applicable code of practice.

For installations in hazardous locations, the transmitter must be installed according to the Rosemount 3408 [Product Certifications](#) document and System Control Drawing.

### **⚠ WARNING**

**Explosions could result in death or serious injury.**

Before connecting a handheld communicator in an explosive atmosphere, ensure that the instruments are installed in accordance with intrinsically safe or non-incendive field wiring practices.

In Explosion-proof/Flameproof and Non-Incendive/Type Ex ec installations, do not remove the transmitter cover when power is applied to the unit.

The transmitter cover must be fully engaged to meet Explosion-proof/Flameproof requirements.

### **⚠ WARNING**

**Electrical shock could cause death or serious injury.**

Ensure the mains power to the transmitter is off and the lines to any other external power source are disconnected or not powered while wiring the transmitter.

**⚠ WARNING****Process leaks could result in death or serious injury.**

Ensure that the transmitter is handled carefully. If the process seal is damaged, gas might escape from the tank.

---

**⚠ WARNING****Physical access**

Unauthorized personnel may potentially cause significant damage to and/or misconfiguration of end users' equipment. This could be intentional or unintentional and needs to be protected against.

Physical security is an important part of any security program and fundamental in protecting your system. Restrict physical access by unauthorized personnel to protect end users' assets. This is true for all systems used within the facility.

---

**⚠ CAUTION****Hot surfaces**

The flange and process seal may be hot at high process temperatures. Allow to cool before servicing.



## 1.2 Product recycling/disposal

Recycling of equipment and packaging should be taken into consideration and disposed of in accordance with local and national legislation or regulations.

### 1.3 Spare part numbers

**Figure 1-1: LCD Display**

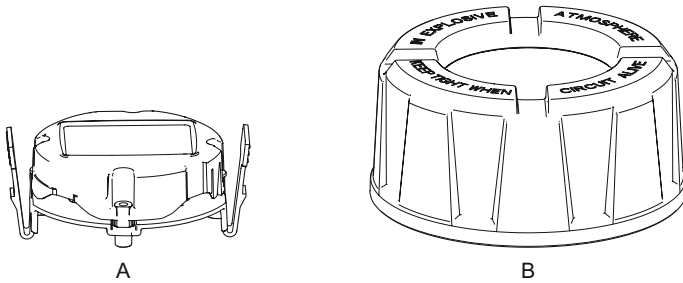

- A. Graphical LCD display
- B. Display cover

**Table 1-1: Spare Parts Kits**

Part number	Description
03408-5000-0001	Graphical LCD (without cover)
03408-5000-0002	Graphical LCD with Bluetooth® connectivity (without cover)
03408-5000-0003	Graphical LCD upgrade kit (with display cover)
03408-5000-0004	Graphical LCD with Bluetooth connectivity (with display cover)

### 1.4 Bluetooth® UID and key

You can find the UID and key on the display unit and on the attached paper tag.

**Figure 1-2: Bluetooth Security Information**

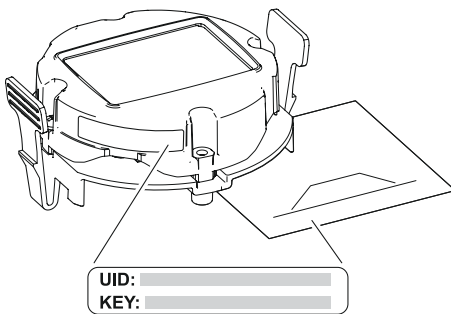

## 2 Install the new LCD display

### Prerequisites

Make sure that the device is not exposed to moisture or dust.

### Procedure

1. ⚠️ Disconnect the power supply.
2. Turn the jam screw clockwise until it is completely threaded into the housing.

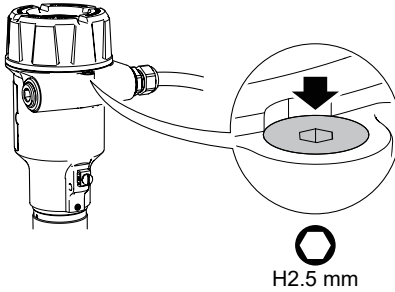

3. Remove the cover.

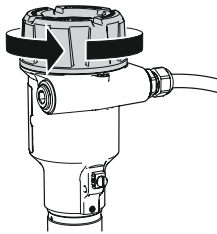

4. Remove the old LCD display (if fitted).

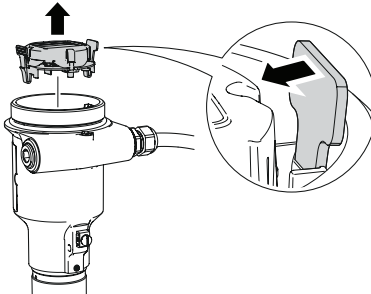

5. Snap the LCD display into place.

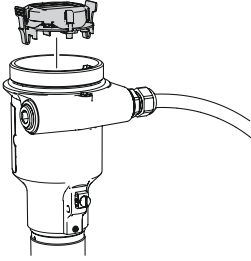

6. Attach and tighten the cover.

a) Verify the cover jam screw is completely threaded into the housing.

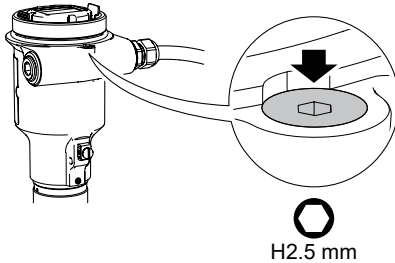

b) Attach and tighten the cover.

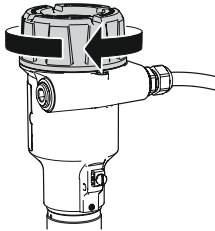

---

**Note**

Make sure the cover is fully engaged. There should be no gap between the cover and the housing.

---

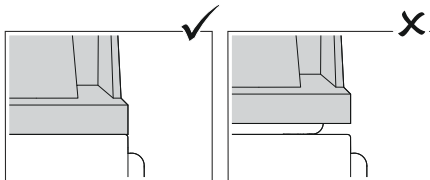

- c) Turn the jam screw counterclockwise until it contacts the cover.

---

**Note**

Required for explosion-proof/flameproof installations only.

---

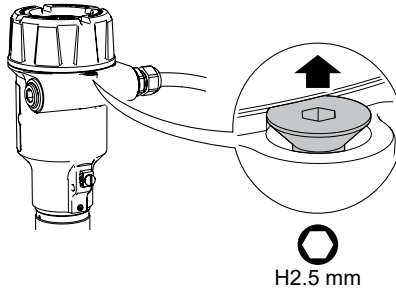

- d) Turn the jam screw an additional  $\frac{1}{2}$  turn counterclockwise to secure the cover.

7. Connect the power supply.

### 3 Affix the radio certification sticker

#### Prerequisites

This only applies when upgrading to an LCD display with Bluetooth® connectivity.

#### Procedure

1. Check the FCC ID and IC numbers on the main label.
2. Pick the sticker with the same FCC ID and IC numbers, but with an additional "B" at the end.
3. Affix the sticker on the main label over the original FCC ID, IC, and HVIN numbers.

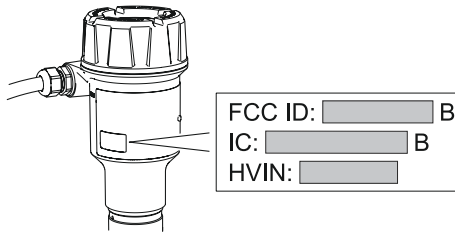











**Quick Start Guide**  
**00825-0300-4418, Rev. AB**  
**May 2023**

For more information: [Emerson.com](https://www.emerson.com)

©2023 Emerson. All rights reserved.

Emerson Terms and Conditions of Sale are available upon request. The Emerson logo is a trademark and service mark of Emerson Electric Co. Rosemount is a mark of one of the Emerson family of companies. All other marks are the property of their respective owners.

The "Bluetooth" word mark and logos are registered trademarks owned by Bluetooth, SIG, Inc. and any use of such marks by Emerson is under license.

**ROSEMOUNT™**

