

Rosemount™ 3051S Transmitter

with FOUNDATION™ Fieldbus protocol



Safety messages

This document provides basic guidelines for Rosemount™ 3051S Series Pressure Transmitters. It also provides the basic electronic guidelines for the:

- Rosemount 3051SFA
- Rosemount 3051SFC
- Rosemount 3051SFP

It does not provide instructions for diagnostics, maintenance, service, or troubleshooting. Refer to the Reference Manual for more instruction. This document is also available electronically on Emerson.com.

⚠ WARNING

Explosion

Explosions could result in death or serious injury.

Do not remove the transmitter cover in explosive atmospheres when the circuit is live.

Both transmitter covers must be fully engaged to meet explosion-proof requirements.

Ensure device is installed in accordance with intrinsically safe or non-incendive field practices.

⚠ WARNING

Process leak

Process leaks could result in death or serious injury.

To avoid process leaks, only use the O-ring designed to seal with the corresponding flange adapter.

⚠ WARNING

Electric shock

Electrical shock could cause death or serious injury.

Avoid contact with the leads and terminals. High voltage that may be present on leads can cause electrical shock.

⚠ WARNING

Refer to the *Product certifications* section of this Quick Start Guide documentation when using the RFID tag (option code Y3) for required installation conditions.

Contents

Mounting the transmitter..... 5

Tagging..... 14

Rotate housing..... 15

Connect wiring and power up..... 16

Verify configuration..... 21

Trim the transmitter..... 23

Rosemount 3051S/3051SFx/3051S-ERS..... 24

Declaration of Conformity..... 46

China RoHS..... 50

1 Mounting the transmitter

1.1 Liquid flow applications

Procedure

1. Place taps to the side of the line.
2. Mount beside or below the taps.
3. When mounting the transmitter, orientate the drain/vent valves upward.

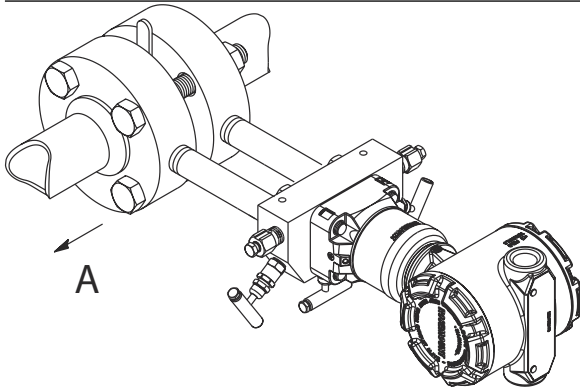

A. Direction of flow

1.2 Gas flow applications

Procedure

1. Place taps in the top or side of the line.

2. Mount beside or above the taps.
-

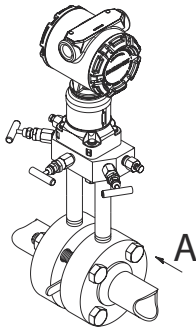

A. Direction of flow

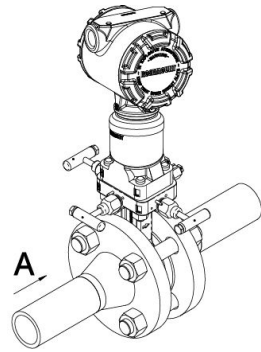

1.3 Steam flow applications

Procedure

1. Place taps to the side of the line.
2. Mount beside or below the taps.

3. Fill impulse lines with water.

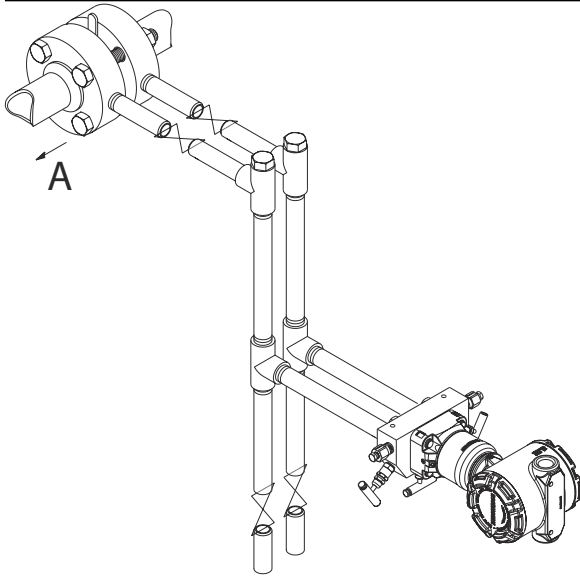

A. Direction of flow

1.4 Using a mounting bracket

If the transmitter requires a mounting bracket, use the following images for instructions on how to properly mount the transmitter using the Emerson provided mounting brackets.

NOTICE

Use only bolts provided with the transmitter or sold as Emerson spare parts.

1.4.1 Mounting brackets

Figure 1-1: Mounting bracket - Coplanar™ flange

Panel mount

Pipe mount

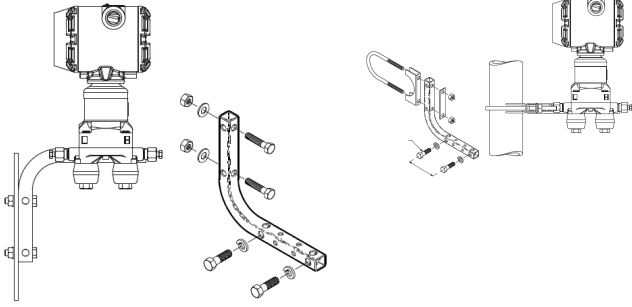

Figure 1-2: Mounting brackets - traditional flange

Panel mount

Pipe mount

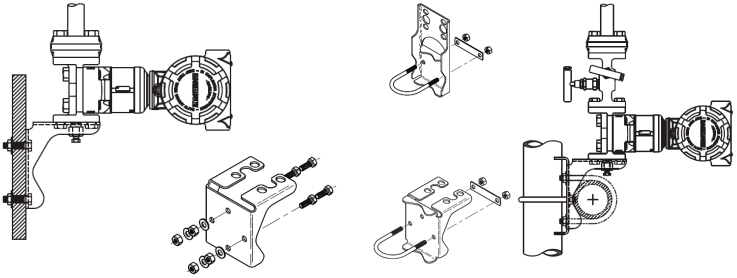
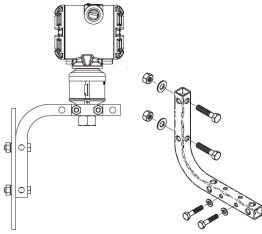
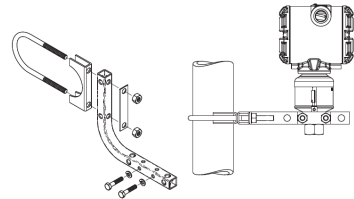

Figure 1-3: Mounting brackets - in-line

Panel mount



Pipe mount



1.5 Bolting considerations

If the transmitter installation requires assembly of a process flange, manifold, or flange adapters, follow these assembly guidelines to ensure a tight seal for optimal transmitter performance characteristics.

NOTICE

Only use bolts supplied with the transmitter or sold by Emerson as spare parts.

[Figure 1-4](#) illustrates common transmitter assemblies with the bolt length required for proper transmitter assembly.

Figure 1-4: Common transmitter assemblies

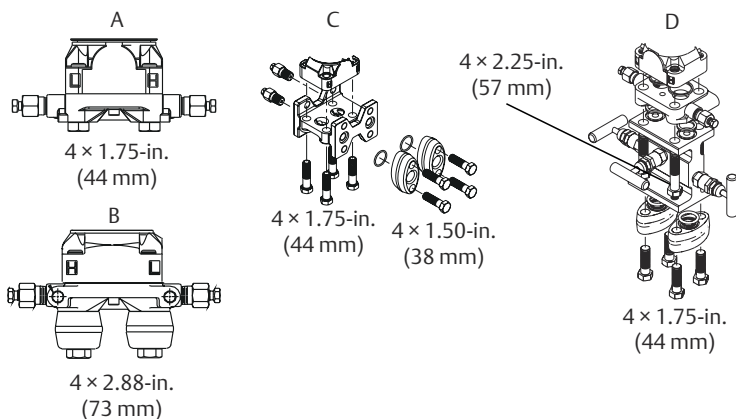

- A. Transmitter with Coplanar™ flange
- B. Transmitter with Coplanar flange and optional flange adapters
- C. Transmitter with traditional flange and optional flange adapters
- D. Transmitter with Coplanar flange and optional Rosemount Conventional Manifold and flange adapters

Note

For all other manifolds, visit Emerson.com/global.

Table 1-1: Torque values for the flange and flange adapter bolts

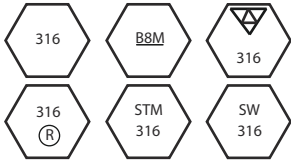
Bolt material	Head markings	Initial torque	Final torque
Carbon steel (CS)		300 in-lb.	650 in-lb.
Stainless steel (SST)		150 in-lb.	300 in-lb.

Bolts are typically carbon steel or stainless steel. Confirm the material by viewing the markings on the head of the bolt and referencing [Table 1-1](#). If bolt material is not shown in [Table 1-1](#), contact your local Emerson representative for more information.

NOTICE

Do not apply additional lubricant when installing either type of bolt. Carbon steel bolts do not require lubrication. Stainless steel bolts are coated with a lubricant to ease installation.

To install bolts:

Procedure

1. Finger-tighten the bolts.
2. Torque the bolts to the initial torque value using a crossing pattern.
See [Table 1-1](#) for initial torque value.
3. Torque the bolts to the final torque value using the same crossing pattern.
See [Table 1-1](#) for final torque value.
4. Verify the flange bolts are protruding through the sensor module before applying pressure.
See [Figure 1-5](#).

Example

Figure 1-5: Proper bolt installation

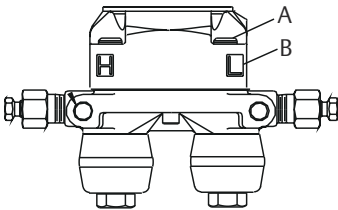

- A. Bolt
B. Sensor module

1.6 O-rings with flange adapters

⚠ WARNING

Process leak

Improperly installed flange adapter O-rings could cause process leaks which could result in death or serious injury.

Only use the O-ring that is designed for its specific flange adapter.

⚠ WARNING

Figure 1-6: O-Ring flange adapter

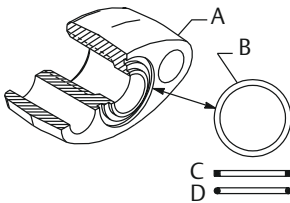

- A. Flange adapter
- B. O-ring
- C. PTFE-based profile (square)
- D. Elastomer profile (round)

Whenever the flange or adapters are removed, visually inspect the O-rings. Replace them if there are any signs of damage, such as nicks or cuts. If the O-rings are replaced, re-torque the flange bolts and alignment screws after installation to compensate for seating of the O-rings.

1.7 In-line gage transmitter orientation

The low side pressure port (atmospheric reference) on the in-line gage transmitter is located under the sensor module neck label (see [Figure 1-7](#)).

Mounting the transmitter so that any containinants can drain away keeps the vent path free of any obstruction, including but not limited to:

- Paint
- Dust

- Lubrication

Figure 1-7: In-line gage transmitter

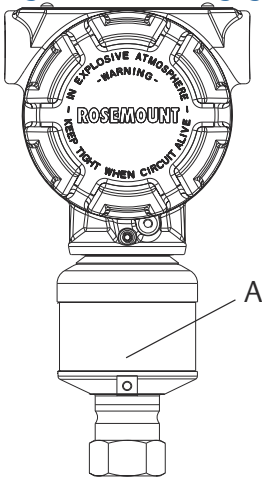

A. Low side pressure port (under neck label)

2 Tagging

This procedure helps identify which device is at a particular location.

Commissioning (paper) tag

Use the removable tag provided with the transmitter.

Procedure

1. Ensure the physical device tag (**PD Tag** field) is properly entered in both places on the commissioning tag.

Note

The device description loaded in the host system must be at the same revision as this device. The device description can be downloaded from Emerson.com or FieldCommGroup.org.

2. Tear off the bottom portion of the tag and write `physical tag` on this portion.
-

Figure 2-1: Commissioning tag

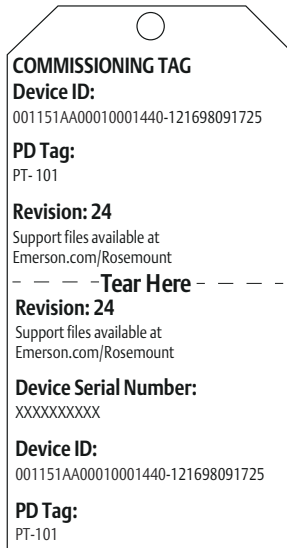

You can now give this to the person who can associate the device ID to the desired tag.

3 Rotate housing

To improve field access to wiring or to better view the optional LCD display:

Procedure

1. Loosen the housing rotation set screw.
2. Turn the housing up to 180° left or right of its original (as shipped) position.
3. Re-tighten the housing rotation set screw.

Figure 3-1: Transmitter housing set screw

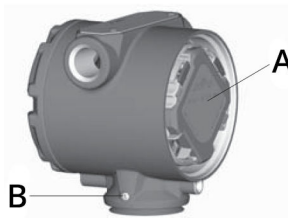

A. LCD display

B. Housing rotation set screw (3/32 in.)

NOTICE

Over-rotation may sever the electrical connection between the sensor module and the electronics. Do not rotate the housing more than 180° without first performing a disassembly procedure.

4 Connect wiring and power up

Prerequisites

The transmitter requires 9-32 Vdc to operate. Type A FOUNDATION™ Fieldbus wiring 18 AWG twisted shielded pair is recommended.

Procedure

1. Remove and discard orange conduit plugs.
2. Remove the housing cover labeled Field Terminals.

Note

Do not connect the power across the test terminals. Power could damage the test diode in the test connection. Twisted pairs yield best results. Use 24–14 AWG wire and do not exceed 5,000 ft. (1,500 m). For single compartment housing (Junction Box housing), shielded signal wiring should be used in high EMI/RFI environments.

3. Connect the positive lead to the + terminal, and the negative lead to the – terminal.
4. Connect the power leads to the terminals indicated on the terminal block.

Figure 4-1: Transmitter wiring

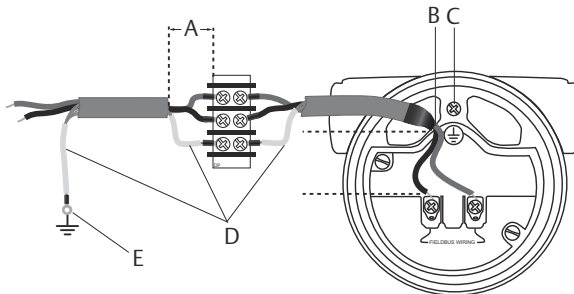

- A. Minimize distance
- B. Trim shield and insulate
- C. Ground for transient protection
- D. Insulate shield
- E. Connect shield back to power supply ground

Note

The device power terminals are polarity insensitive, which means the electrical polarity of the power leads does

not matter when connecting to the power terminals. If polarity sensitive devices are connected to the segment, follow terminal polarity. When wiring to the screw terminals, Emerson recommends using crimped legs.

5. Plug and seal the unused conduit connection with the provided conduit plug.

NOTICE

When the enclosed threaded plug is utilized in the conduit opening, it must be installed with a minimum thread engagement in order to comply with explosion-proof requirements.

- For straight threads, a minimum of seven threads must be engaged.
- For tapered threads, a minimum of five threads must be engaged.

6. If applicable, install wiring with a drip loop. Arrange the drip loop so the bottom is lower than the conduit connections and the transmitter housing.
7. Reinstall the housing cover and tighten so the cover is fully seated with metal to metal contact between the housing and cover in order to meet explosion-proof requirements.

The following figures show the wiring connections necessary to power a transmitter and enable communications with a handheld Field Communicator.

Figure 4-2: Transmitter Wiring for Plantweb Housing

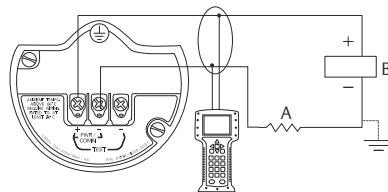

A. $RL \geq 250 \Omega$

B. Power supply

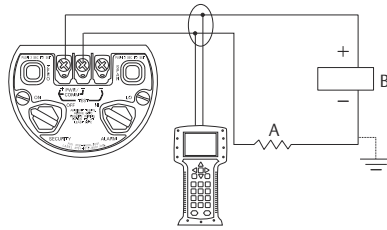
Figure 4-3: Transmitter Wiring for Junction Box Housing

A. $RL \geq 250 \Omega$

B. Power supply

Note

Installation of the transient protection terminal block does not provide transient protection unless the Rosemount 3051S case is properly grounded.

4.1 Ground signal wiring

Do not run signal wiring in conduit or open trays with power wiring, or near heavy electrical equipment. Grounding terminations are provided on the sensor module and inside the terminal compartment. These grounds are used when transient protection terminal blocks are installed or to fulfill local regulations.

Procedure

1. Remove the Field Terminals housing cover.
2. Connect the wiring pair and ground as indicated in [Figure 4-4](#).
The cable shield should:
 - Be trimmed close and insulated from touching the transmitter housing
 - Continuously connect to the termination point
 - Be connected to a good earth ground at the power supply end

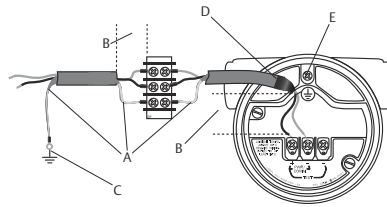
Figure 4-4: Wiring

- A. Insulate shield
- B. Minimize distance
- C. Connect shield back to the power supply ground
- D. Trim shield and insulate
- E. Safety ground

3. Connect the wiring pair and ground as indicated in [Figure 4-1](#). The cable shield should:
 - Be trimmed close and insulated from touching the transmitter housing
 - Continuously connect to the termination point
 - Be connected to a good earth ground at the power supply end
4. Replace the housing cover.

Note

Emerson recommends tightening the cover until no gap is present between the cover and the housing.

5. Plug and seal the unused conduit connection with the provided conduit plug.

4.2 Conduit electrical connector wiring (option GE or GM)

For Rosemount 3051S with conduit electrical connectors GE or GM, refer to the cordset manufacturer's installation instructions for wiring details. For FM Intrinsically Safe, non-incendive, or FM FISCO Intrinsically Safe hazardous locations, install in accordance with Rosemount drawing 03151-1009.

Additional information can be found in the Rosemount 3051S Reference Manual.

4.3 Power supply

The DC power supply should provide power with less than two percent ripple. The total resistance load is the sum of the resistance of the signal leads and the load resistance of the

- Controller
- Indicator
- Related pieces

Note

If intrinsic safety barriers are used, their resistance must be included.

Figure 4-5: Load Limitation

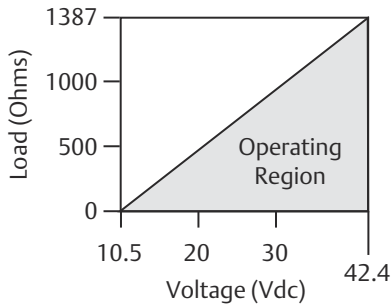

Maximum loop resistance = $43.5 \times (\text{power supply voltage} - 10.5)$

NOTICE

The Field Communicator requires a minimum loop resistance of 250Ω for communication.

The transmitter requires between 9 and 32 Vdc to operate and provide complete functionality.

5 Verify configuration

Use the following block examples to do basic configuration to the transmitter. For more advanced configurations see the Rosemount 3051S FOUNDATION™ Fieldbus [Reference Manual](#).

Note

DeltaV™ users should use DeltaV Explorer for the resource and transducer blocks and Control Studio for the function blocks.

5.1 Analog input (AI) block configuration parameters

Use the following tables as a guide when configuring the AI block:

- [Pressure example](#)
- [Differential pressure \(DP\) flow](#)
- [DP level example](#)

Parameters	Enter data				
Channel	1 = Pressure or 2 = Sensor temp				
L_Type	Direct, indirect, or square root				
XD_Scale	Scale and engineering units				
	Pa	bar	inH ₂ O @ 68 °F	cmH ₂ O @ 4 °C	inHg @ 0 °C
	kPa	mbar	mmH ₂ O @ 68 °F	ftH ₂ O	mmHg @ 0 °C
	MPa	atm	ftH ₂ O @ 68 °F	inH ₂ O	mmH ₂ O @ 4 °C
	hPa	psf	inH ₂ O @ 60 °F	g/cm ²	inH ₂ O @ 4 °C
	psi	°C	ftH ₂ O @ 60 °F	kg/m ²	mHg @ 0 °C
	torr	°F	ftH ₂ O @ 4 °C	kg/cm ²	cmHg @ 0 °C
					mH ₂ O @ 4 °C
Out_Scale	Scale and engineering units				

Pressure example

Parameters	Enter data
Channel	1
L_Type	Direct

Parameters	Enter data
XD_Scale	See list of supported engineering units.
Out_Scale	Set values outside operating range.

Differential pressure (DP) flow

Parameters	Enter data
Channel	1
L_Type	Square root
XD_Scale	0-100 inH ₂ O @ 68 °F
Out_Scale	0-20 GPM

DP level example

Parameters	Enter data
Channel	1
L_Type	Indirect
XD_Scale	0-300 inH ₂ O @ 68 °F
Out_Scale	0-25 ft.

To display pressure on the LCD display meter

Select the **Pressure** check box on the *Display Configuration* screen.

Note

To display level or flow, use AI block out.

6 Trim the transmitter

Transmitters are shipped fully calibrated per request or by the factory default of full scale (**Lower Range Value** = zero, **Upper Range Value** = upper range limit).

6.1 Zero trim

A zero trim is a single-point adjustment used for compensating mounting position and line pressure effects. When performing a zero trim, ensure the equalizing valve is open and all wet legs are filled to the correct level.

The transmitter only allows three to five percent URL zero error to be trimmed. For greater zero errors, compensate for the offset by using the following parts of the analog input (AI) block:

- **XD_Scaling**
- **Out_Scaling**
- **Indirect L_Type**

Using the host system

Perform a zero trim method if the host system supports methods associated with the Transducer 1100 block. Otherwise, if the host system does not support methods, see [Rosemount 3051S FOUNDATION™ Fieldbus Reference Manual](#).

7 Rosemount 3051S/3051SFx/3051S-ERS

Rev 3.14

European Directive Information

A copy of the EU Declaration of Conformity can be found at the end of the Quick Start Guide. The most recent revision of the EU Declaration of Conformity can be found at emerson.com/rosemount.

Ordinary Location Certification

As standard, the transmitter has been examined and tested to determine that the design meets the basic electrical, mechanical, and fire protection requirements by a nationally recognized test laboratory (NRTL) as accredited by the Federal Occupational Safety and Health Administration (OSHA).

Installing Equipment in North America

The US National Electrical Code (NEC) and the Canadian Electrical Code (CEC) permit the use of Division marked equipment in Zones and Zone marked equipment in Divisions. The markings must be suitable for the area classification, gas, and temperature class. This information is clearly defined in the respective codes.

7.1 USA

7.1.1 E5 US Explosionproof (XP) and Dust-Ignitionproof (DIP)

Certificate FM16US0090

Standards FM Class 3600 – 2018, FM Class 3615 – 2018, FM Class 3616 – 2011, FM Class 3810 – 2018, ANSI/NEMA 250 – 2003

Markings XP CL I, DIV 1, GP B, C, D; DIP CL II, DIV 1, GP E, F, G; CL III; T5(-50 °C ≤ T_a ≤ +85 °C); Factory Sealed; Type 4X

7.1.2 I5 US Intrinsic Safety (IS) and Nonincendive (NI)

Certificate FM16US0089X

Standards FM Class 3600:2018, FM Class 3610:2010, FM Class 3611:2004, FM Class 3616:2011, FM Class 3810:2018, ANSI/ISA-60079-0:2013, ANSI/ISA-60079-11:2013, ANSI/ISA-61010-1:2004, NEMA 250:1991 (3051SFA only) or NEMA 250:2003

Markings IS CL I, DIV 1, GP A, B, C, D; CL II, DIV 1, GP E, F, G; Class III; Class 1, Zone 0 AEx ia IIC T4; NI CL 1, DIV 2, GP

A, B, C, D; T4(-50 °C ≤ T_a ≤ +70 °C) [HART]; T4(-50 °C ≤ T_a ≤ +60 °C) [Fieldbus]; when connected per Rosemount drawing 03151-1006; Type 4X

Special Condition for Safe Use (X):

The Model 3051S/3051S-ERS Pressure Transmitter contains aluminum and is considered to constitute a potential risk of ignition by impact or friction. Care must be taken into account during installation and use to prevent impact and friction.

Note

Transmitters marked with NI CL 1, DIV 2 can be installed in Division 2 locations using general Division 2 wiring methods or Nonincendive Field Wiring (NIFW). See Drawing 03151-1006.

US Intrinsic Safety (IS) and Nonincendive (NI)

Certificate 1143113

Standards FM Class 3600:2011, FM Class 3610:2010, FM Class 3611:2004, FM Class 3810:2005, UL50E (1st Ed.)

Markings IS Class I/II/III, Division 1, Groups A, B, C, D, T4/ E, F, and G T135 °C;
 Class I, Zone 0 AEx ia IIC T4 Ga;
 T4(-50 °C ≤ T_a ≤ +70 °C) [HART];
 T4(-50 °C ≤ T_a ≤ +60 °C) [Fieldbus];
 when connected per Rosemount drawing 03151-1016;
 Type 4X

7.1.3 IE US FISCO

Certificate FM16US0089X

Standards FM Class 3600 – 2011, FM Class 3610 – 2010, FM Class 3611 – 2004, FM Class 3810 – 2005, NEMA 250 – 2003

Markings IS CL I, DIV 1, GP A, B, C, D; T4(-50 °C ≤ T_a ≤ +60 °C); when connected per Rosemount drawing 03151-1006; Type 4X

Special Condition for Safe Use (X):

The Model 3051S/3051S-ERS Pressure Transmitter contains aluminum and is considered to constitute a potential risk of ignition by impact or friction. Care must be taken into account during installation and use to prevent impact and friction.

US FISCO

Certificate	1143113
Standards	FM Class 3600:2011, FM Class 3610:2010, FM Class 3611:2004, FM Class 3810:2005, UL50E (1st Ed.)
Markings	IS Class I/II/III, Division 1, Groups A, B, C, D, T4/ E, F, and G T135 °C; Class I, Zone 0 AEx ia IIC T4 Ga; T4(-50 °C ≤ T _a ≤ +70 °C) [HART]; T4(-50 °C ≤ T _a ≤ +60 °C) [Fieldbus]; when connected per Rosemount drawing 03151-1016; Type 4X

7.2 Canada

7.2.1 E6 Canada Explosionproof, Dust-Ignitionproof, and Division 2

Certificate	1143113
Standards	CAN/CSA C22.2 No. 0-10, CSA Std C22.2 No. 25-1966, CSA Std C22.2 No. 30-M1986, CAN/CSA C22.2 No. 94-M91, CSA Std C22.2 No. 142-M1987, CSA Std C22.2 No. 213-M1987, ANSI/ISA 12.27.01-2003, CSA Std C22.2 No. 60529:05
Markings	Explosionproof Class I, Division 1, Groups B, C, D; Dust-Ignitionproof Class II, Division 1, Groups E, F, G; Class III; suitable for Class I, Zone 1, Group IIB+H2, T5; suitable for Class I, Division 2, Groups A, B, C, D; suitable for Class I, Zone 2, Group IIC, T5; when connected per Rosemount drawing 03151-1013; Type 4X

7.2.2 I6 Canada Intrinsically Safe

Certificate	1143113
Standards	CAN/CSA C22.2 No. 0-10, CSA Std C22.2 No. 30-M1986, CAN/CSA C22.2 No. 94-M91, CSA Std C22.2 No. 142-M1987, CSA Std C22.2 No. 157-92, ANSI/ISA 12.27.01-2003, CSA Std C22.2 No. 60529:05
Markings	Intrinsically Safe Class I, Division 1; Groups A, B, C, D; suitable for Class 1, Zone 0, IIC, T3C; when connected per Rosemount drawing 03151-1016 [3051S] 03151-1313 [ERS]; Type 4X

7.2.3 IF Canada FISCO

Certificate	1143113
--------------------	---------

Standards CAN/CSA C22.2 No. 0-10, CSA Std C22.2 No. 30-M1986, CAN/CSA C22.2 No. 94-M91, CSA Std C22.2 No. 142-M1987, CSA Std C22.2 No. 157-92, ANSI/ISA 12.27.01-2003, CSA Std C22.2 No. 60529:05

Markings FISCO Intrinsically Safe Class I, Division 1; Groups A, B, C, D; suitable for Class 1, Zone 0, IIC, T3C; when connected per Rosemount drawing 03151-1016 [3051S] 03151-1313 [ERS]; Type 4X

7.3 Europe

7.3.1 E1 ATEX Flameproof

Certificate KEMA 00ATEX2143X

Standards EN IEC 60079-0:2018, EN 60079-1:2014, EN 60079-26:2015

Markings  II 1/2 G Ex db IIC T6...T4 Ga/Gb, T6(-60 °C ≤ T_a ≤ +70 °C), T5/T4(-60 °C ≤ T_a ≤ +80 °C)

Temperature Class	Process Connection Temperature
T6	-60 °C to +70 °C
T5	-60 °C to +80 °C
T4	-60 °C to +120 °C

Special Conditions for Safe Use (X):

1. This device contains a thin wall diaphragm less than 1 mm thickness that forms a boundary between Category 1G (process connection) and Category 2G (all other parts of the equipment). The model code and datasheet are to be consulted for details of the diaphragm material. During Installation, maintenance and use the environmental conditions to which the diaphragm will be subjected shall be taken into account. The manufacturer's instructions for installation and maintenance shall be followed in detail to assure safety during its expected lifetime.
2. Flameproof joints are not intended for repair.
3. Non-standard paint options may cause risk from electrostatic discharge. Avoid installations that could cause electrostatic build-up on painted surfaces, and only clean the painted surfaces with a damp cloth. If paint is ordered through

a special option code, contact the manufacturer for more information.

- Appropriate cable, glands and plugs need to be suitable for a temperature of 5 °C greater than maximum specified temperature for location where installed.

7.3.2 I1 ATEX Intrinsic Safety

Certificate BAS01ATEX1303X

Standards EN IEC 60079-0: 2018, EN 60079-11: 2012

Markings  II 1 G Ex ia IIC T4 Ga, T4(-60 °C ≤ T_a ≤ +70 °C)

Table 7-1: Input Parameters

	Ui	Ii	Pi	Ci	Li
SuperModule	30 V	300 mA	1.0 W	30 nF	0
3051S...A; 3051SF...A; 3051SAL...C	30 V	300 mA	1.0 W	12 nF	0
3051S...F; 3051SF...F	30 V	300 mA	1.3 W	0	0
3051S ...A...M7, M8, or M9; 3051SF ...A...M7, M8, or M9; 3051SAL...C... M7, M8, or M9	30 V	300 mA	1.0 W	12 nF	60 μH
3051SAL or 3051SAM	30 V	300 mA	1.0 W	12 nF	33 μH
3051SAL...M7, M8, or M9 3051SAM...M7, M8, or M9	30 V	300 mA	1.0 W	12 nF	93 μH
RTD Option for 3051SF	5 V	500 mA	0.63 W	N/A	N/A

Special Conditions for Safe Use (X):

- The Model 3051S Transmitters fitted with transient protection are not capable of withstanding the 500V test as defined in Clause 6.3.13 of EN 60079-11:2012. This must be taken into account during installation.
- The terminal pins of the Model 3051S SuperModule must be provided with a degree of protection of at least IP20 in accordance with IEC/EN 60529.
- The Model 3051S enclosure may be made of aluminum alloy and given a protective polyurethane paint finish; however,

care should be taken to protect it from impact or abrasion if located in a zone 0 area.

7.3.3 IA ATEX FISCO

Certificate BAS01ATEX1303X

Standards EN IEC 60079-0: 2018, EN 60079-11: 2012

Markings  II 1 G Ex ia IIC T4 Ga, T4(-60 °C ≤ T_a ≤ +70 °C)

Table 7-2: Input Parameters

	FISCO
Voltage U _i	17.5 V
Current I _i	380 mA
Power P _i	5.32 W
Capacitance C _i	0
Inductance L _i	0

Special Conditions for Safe Use (X):

1. The Model 3051S Transmitters fitted with transient protection are not capable of withstanding the 500V test as defined in Clause 6.3.13 of EN 60079-11:2012. This must be taken into account during installation.
2. The terminal pins of the Model 3051S SuperModule must be provided with a degree of protection of at least IP20 in accordance with IEC/EN 60529.
3. The Model 3051S enclosure may be made of aluminum alloy and given a protective polyurethane paint finish; however, care should be taken to protect it from impact or abrasion if located in a zone 0 area.

7.3.4 ND ATEX Dust

Certificate BAS01ATEX1374X

Standards EN 60079-0: 2012+A11:2013, EN 60079-31: 2009

Markings  II 1 D Ex ta IIIC T105 °C T₅₀₀95 °C Da, (-20 °C ≤ T_a ≤ +85 °C), V_{max} = 42.4 V

Special Conditions for Safe Use (X):

1. Cable entries must be used which maintain the ingress protection of the enclosure to at least IP66.

2. Unused cable entries must be filled with suitable blanking plugs which maintain the ingress protection of the enclosure to at least IP66.
3. Cable entries and blanking plugs must be suitable for the ambient temperature range of the apparatus and capable of withstanding a 7J impact test.
4. The SuperModule(s) must be securely screwed in place to maintain the ingress protection of the enclosure(s).

7.3.5 N1 ATEX Type n

Certificate BAS01ATEX3304X

Standards EN IEC 60079-0: 2018, EN 60079-15: 2010

Markings  II 3 G Ex nA IIC T5 Gc, (-40 °C ≤ T_a ≤ +85 °C), V_{max} = 45 V

Special Condition for Safe Use (X):

The equipment is not capable of withstanding the 500 V insulation test required by clause 6.5 of EN 60079-15:2010. This must be taken into account when installing the equipment.

Note

RTD Assembly is not included with the 3051SFx Type n Approval.

7.4 International

7.4.1 E7 IECEx Flameproof and Dust

Certificate IECEx KEM 08.0010X (Flameproof)

Standards IEC 60079-0:2017, IEC 60079-1:2014, IEC 60079-26:2014

Markings Ex db IIC T6...T4 Ga/Gb, T6(-60 °C ≤ T_a ≤ +70 °C), T5/T4(-60 °C ≤ T_a ≤ +80 °C)

Table 7-3: Process Temperature

Temperature class	Process Connection Temperature
T6	-60 °C to +70 °C
T5	-60 °C to +80 °C
T4	-60 °C to +120 °C

Special Conditions for Safe Use (X):

1. This device contains a thin wall diaphragm less than 1 mm thick that forms a boundary between EPL Ga (process connection) and EPL Gb (all other parts of the equipment). The model code and datasheet are to be consulted for details of the diaphragm material. During installation, maintenance and use the environmental conditions to which the diaphragm will be subjected shall be taken into account. The manufacturer's instructions for installation and maintenance shall be followed in detail to assure safety during its expected lifetime.
2. Flameproof joints are not intended for repair.
3. Non-standard paint options may cause risk from electrostatic discharge. Avoid installations that could cause electrostatic build-up on painted surfaces, and only clean the painted surfaces with a damp cloth. If paint is ordered through a special option code, contact the manufacturer for more information.
4. Appropriate cable, glands and plugs need to be suitable for a temperature of 5 °C greater than maximum specified temperature for location where installed.

Certificate IECEx BAS 09.0014X (Dust)

Standards IEC 60079-0:2011, IEC 60079-31:2008

Markings Ex ta IIIC T105 °C T₅₀₀ 95 °C Da, (-20 °C ≤ T_a ≤ +85 °C), V_{max} = 42.4 V

Special Conditions for Safe Use (X):

1. Cable entries must be used which maintain the ingress protection of the enclosure to at least IP66.
2. Unused cable entries must be filled with suitable blanking plugs which maintain the ingress protection of the enclosure to at least IP66.
3. Cable entries and blanking plugs must be suitable for the ambient temperature range of the apparatus and capable of withstanding a 7J impact test.
4. The 3051S- SuperModule must be securely screwed in place to maintain the ingress protection of the enclosure.

7.4.2 I7 IECEx Intrinsic Safety

Certificate IECEx BAS 04.0017X

Standards IEC 60079-0: 2017, IEC 60079-11: 2011

Markings Ex ia IIC T4 Ga, T4(-60 °C ≤ T_a ≤ +70 °C)

Table 7-4: Input Parameters

	Ui	Ii	Pi	CI	LI
SuperModule	30 V	300 mA	1.0 W	30 nF	0
3051S...A; 3051SF...A; 3051SAL...C	30 V	300 mA	1.0 W	12 nF	0
3051S...F; 3051SF...F	30 V	300 mA	1.3 W	0	0
3051S ...A...M7, M8, or M9; 3051SF ...A... M7, M8, or M9; 3051SAL...C... M7, M8, or M9	30 V	300 mA	1.0 W	12 nF	60 μH
3051SAL or 3051SAM	30 V	300 mA	1.0 W	12 nF	33 μH
3051SAL...M7, M8, or M9 3051SAM...M7, M8, or M9	30 V	300 mA	1.0 W	12 nF	93 μH
RTD Option for 3051SF	5 V	500 mA	0.63 W	N/A	N/A

Special Conditions for Safe Use (X):

1. The Model 3051S Transmitters fitted with transient protection are not capable of withstanding the 500 V test as defined in Clause 6.3.13 of EN 60079-11:2012. This must be taken into account during installation.
2. The terminal pins of the Model 3051S SuperModule must be provided with a degree of protection of at least IP20 in accordance with IEC/EN 60529.
3. The Model 3051S enclosure may be made of aluminum alloy and given a protective polyurethane paint finish; however, care should be taken to protect it from impact or abrasion if located in a zone 0 area.

7.4.3 I7 IECEx Intrinsic Safety – Group I - Mining (I7 with Special A0259)

Certificate IECEx TSA 14.0019X

Standards IEC 60079-0: 2011, IEC 60079-11: 2011

Markings Ex ia I Ma (-60 °C ≤ T_a ≤ +70 °C)

Table 7-5: Input Parameters

	U_i	I_i	P_i	C_i	L_i
SuperModule	30 V	300 mA	1.0 W	30 nF	0
3051S...A; 3051SF...A; 3051SAL...C	30 V	300 mA	1.0 W	12 nF	0
3051S...F; 3051SF...F	30 V	300 mA	1.3 W	0	0
3051S ...A...M7, M8, or M9; 3051SF ...A... M7, M8, or M9; 3051SAL...C... M7, M8, or M9	30 V	300 mA	1.0 W	12 nF	60 μH
3051SAL or 3051SAM	30 V	300 mA	1.0 W	12 nF	33 μH
3051SAL...M7, M8, or M9 3051SAM...M7, M8, or M9	30 V	300 mA	1.0 W	12 nF	93 μH
RTD Option for 3051SF	5 V	500 mA	0.63 W	N/A	N/A

Special Conditions for Safe Use (X):

1. If the apparatus is fitted with optional 90V transient suppressor, it is not capable of withstanding the 500 V insulation test required by Clause 6.3.13 of IEC60079-11. This must be taken into account when installing the apparatus.
2. It is a condition of safe use that the above input parameters shall be taken into account during installation.
3. It is a condition of manufacture that only the apparatus fitted with housing, covers and sensor module housing made out of stainless steel are used in Group I applications.

7.4.4 IG IECEx FISCO

Certificate	IECEx BAS 04.0017X
Standards	IEC 60079-0: 2017, IEC 60079-11: 2011
Markings	Ex ia IIC T4 Ga, T4(-60 °C ≤ T _a ≤ +70 °C)

Table 7-6: Input Parameters

Parameter	FISCO
Voltage U _i	17.5 V
Current I _i	380 mA

Table 7-6: Input Parameters
(continued)

Parameter	FISCO
Power P_i	5.32 W
Capacitance C_i	0
Inductance L_i	0

Special Conditions for Safe Use (X):

1. The Model 3051S Transmitters fitted with transient protection are not capable of withstanding the 500 V test as defined in Clause 6.3.13 of EN 60079-11:2012. This must be taken into account during installation.
2. The terminal pins of the Model 3051S SuperModule must be provided with a degree of protection of at least IP20 in accordance with IEC/EN 60529.
3. The Model 3051S enclosure may be made of aluminum alloy and given a protective polyurethane paint finish; however, care should be taken to protect it from impact or abrasion if located in a zone 0 area.

7.4.5 IG IECEx Intrinsic Safety – Group I – Mining (IG with Special A0259)

Certificate IECEx TSA 14.0019X

Standards IEC 60079-0: 2011, IEC 60079-11: 2011

Markings FISCO FIELD DEVICE Ex ia I Ma , (-60 °C ≤ T_a ≤ +70 °C)

Table 7-7: Input Parameters

Parameter	FISCO
Voltage U_i	17.5 V
Current I_i	380 mA
Power P_i	5.32 W
Capacitance C_i	0
Inductance L_i	0

Special Conditions for Safe Use (X):

1. If the apparatus is fitted with optional 90V transient suppressor, it is not capable of withstanding the 500 V

insulation test required by Clause 6.3.13 of IEC60079-11. This must be taken into account when installing the apparatus.

2. It is a condition of safe use that the above input parameters shall be taken into account during installation.
3. It is a condition of manufacture that only the apparatus fitted with housing, covers and sensor module housing made out of stainless steel are used in Group I applications.

7.4.6 N7 IECEx Type n

Certificate	IECEx BAS 04.0018X
Standards	IEC 60079-0: 2017, IEC 60079-15: 2010
Markings	Ex nA IIC T5 Gc, (-40 °C ≤ T _a ≤ +85 °C)

Special Condition for Safe Use (X):

1. The equipment is not capable of withstanding the 500 V insulation test required by clause 6.5 of EN 60079-15:2010. This must be taken into account when installing the equipment.

7.5 Brazil

7.5.1 E2 Brazil Flameproof

Certificate	UL-BR 15.0393X
Standards	ABNT NBR IEC 60079-0:2013, ABNT NBR IEC 60079-1:2016, ABNT NBR IEC 60079-26:2016
Markings	Ex db IIC T6...T4 Ga/Gb, T6 (-60 °C ≤ T _a ≤ +70 °C), T5/T4 (-60 °C ≤ T _a ≤ +80 °C), IP66

Temperature Class	Ambient Temperature	Process Connection Temperature
T6	-60 °C to +70 °C	-60 °C to +70 °C
T5	-60 °C to +80 °C	-60 °C to +80 °C
T4	-60 °C to +80 °C	-60 °C to +120 °C

Special Conditions for Safe Use (X):

1. The device contains a thin wall diaphragm less than 1mm thick that forms a boundary between EPL Ga (process connection) and EPL Gb (all other parts of the equipment). The model code and datasheet are to be consulted for details of the diaphragm material. Installation, maintenance, and use shall take into account the environmental conditions to which the

diaphragm will be subjected. The manufacturer’s instructions for maintenance shall be followed in detail to assure safety during its expected lifetime.

2. Flameproof joints are not intended for repair.
3. Non-standard paint options may cause risk from electrostatic discharge. Avoid installations that could cause electrostatic build-up on painted surfaces, and only clean the painted surfaces with a damp cloth. If paint is ordered through a special option code, contact the manufacturer for more information.

7.5.2 I2/IB Brazil Intrinsic Safety/FISCO

Certificate UL-BR 15.0392X

Standards ABNT NBR IEC 60079-0:2013, ABNT NBR IEC 60079-11:2013

Markings Ex ia IIC T4 Ga (-60 °C ≤ T_a ≤ +70 °C), IP66

Special Conditions for Safe Use (X):

1. The surface resistivity of the antenna is greater than 1 GΩ. To avoid electrostatic charge build-up, it must not be rubbed or cleaned with solvents or a dry cloth.
2. The Model 701PBKKF Power Module may be replaced in a hazardous area. The Power Module has a surface resistivity greater than 1 GΩ and must be properly installed in the wireless device enclosure. Care must be taken during transportation to and from the point of installation to prevent electrostatic charge build-up.
3. The 3051S enclosure may be made of aluminium alloy and given a protective polyurethane paint finish; however, care must be taken to protect it from impact or abrasion if located in areas that requires EPL Ga.

Table 7-8: Input Parameters

	U_i	I_i	P_i	C_i	L_i
SuperModule	30 V	300 mA	1.0 W	30 nF	0
3051S...A; 3051SF...A; 3051SAL...C	30 V	300 mA	1.0 W	12 nF	0
3051S...F; 3051SF...F	30 V	300 mA	1.3 W	0	0
3051S...F...IB; 3051SF...F...IB	17.5 V	380 mA	5.32 W	0	0

Table 7-8: Input Parameters (continued)

	U_i	I_i	P_i	C_i	L_i
3051S ...A...M7, M8, or M9; 3051SF ...A... M7, M8, or M9; 3051SAL...C... M7, M8, or M9	30 V	300 mA	1.0 W	12 nF	60 μH
3051SAL or 3051SAM	30 V	300 mA	1.0 W	12 nF	33 μH
3051SAL... M7, M8, or M9 3051SAM... M7, M8, or M9	30 V	300 mA	1.0 W	12 nF	93 μH
RTD Option for 3051SF	5 V	500 mA	0.63 W	N/A	N/A

7.6 China

7.6.1 E3 China Flameproof and Dust Ignition-proof

Certificate 3051S: GYJ21.1120X
 3051SFx: GYJ21.3300X
 3051S-ERS: GYJ20.1489X

Standards 3051S: GB3836.1-2010, GB3836.2-2010, GB3836.20-2010, GB12476.1-2013, GB12476.5-2013
 3051SFx: GB3836.1-2010, GB3836.2-2010, GB12476.1-2013, GB 12476.5-2013
 3051S-ERS: GB3836.1-2010, GB3836.2-2010, GB3836.20-2010

Markings 3051S: Ex d IIC T6...T4; Ex tD A20 T105 °C T₅₀₀ 95 °C; IP66
 3051SFx: Ex d IIC T4~T6 Ga/Gb; Ex tD A20 IP66 T105 °C T₅₀₀ 95 °C; IP66
 3051S-ERS: Ex d IIC T4~T6 Ga/Gb

产品安全使用特殊条件

- 证书编号后缀“X”表明产品具有安全使用特殊条件: 涉及隔爆接合面的维修须联系产品制造商。
- 产品使用注意事项
 1. 用于爆炸性气体环境中, 产品使用环境温度与温度组别和介质温度的关系为:

温度组别	环境温度	过程温度
T6	$-60\text{ }^{\circ}\text{C} \leq T_a \leq +70\text{ }^{\circ}\text{C}$	$-60\text{ }^{\circ}\text{C} \leq T_a \leq +70\text{ }^{\circ}\text{C}$
T5	$-60\text{ }^{\circ}\text{C} \leq T_a \leq +80\text{ }^{\circ}\text{C}$	$-60\text{ }^{\circ}\text{C} \leq T_a \leq +80\text{ }^{\circ}\text{C}$
T4	$-60\text{ }^{\circ}\text{C} \leq T_a \leq +80\text{ }^{\circ}\text{C}$	$-60\text{ }^{\circ}\text{C} \leq T_a \leq +120\text{ }^{\circ}\text{C}$

- 用于爆炸性粉尘环境中, 产品使用环境温度为: $-20\text{ }^{\circ}\text{C} \leq T_a \leq +85\text{ }^{\circ}\text{C}$.
- 产品外壳设有接地端子, 用户在使用时应可靠接地。
- 安装现场应不存在对产品外壳有腐蚀作用的有害气体。
- 现场安装时, 电缆引入口须选用国家指定的防爆检验机构按检验认可, 具有 Ex dIIC, Ex tD A20 IP66 防爆等级的电缆引入装置或堵封件, 冗余电缆引入口须用堵封件有效密封。
- 用于爆炸性气体环境中, 现场安装, 使用和维护必须严格遵守“断电后开盖!”的警告语。用于爆炸性粉尘环境中, 现场安装, 使用和维护必须严格遵守“爆炸性粉尘场所严禁开盖!”的警告语。
- 用于爆炸性粉尘环境中, 产品外壳表面需保持清洁, 以防粉尘堆积, 但严禁用压缩空气吹扫。
- 用户不得自行更换该产品的零部件, 应会同产品制造商共同解决运行中出现的故障, 以杜绝损坏现象的发生。
- 产品的安装, 使用和维护应同时遵守产品使用说明书, GB3836.13-2013“爆炸性环境 第 13 部分: 设备的修理, 检修, 修复和改造”, GB3836.15-2000“爆炸性气体环境用电气设备 第 15 部分: 危险场所电气安装(煤矿除外)”, GB3836.16-2006“爆炸性气体环境用电气设备 第 16 部分: 电气装置的检查和维护(煤矿除外)”, GB50257-2014“电气装置安装工程爆炸和火灾危险环境电力装置施工及验收规范”和 GB15577-2007“粉尘防爆安全规程”, GB12476.2-2010“可燃性粉尘环境用电气设备 第 2 部分: 选型和安装”的有关规定。

7.6.2 I3 China Intrinsic Safety

Certificate 3051S: GYJ21.1121X [Mfg USA, China, Singapore]
 3051SFx: GYJ21.3301X [Mfg USA, China, Singapore]
 3051S-ERS: GYJ21.1122X [Mfg USA, China, Singapore]

Standards 3051S: GB3836.1-2010, GB3836.4-2010, GB3836.20-2010
 3051SFx: GB3836.1-2010, GB3836.4-2010,
 GB3836.20-2010

3051S-ERS: GB3836.1-2010, GB3836.4-2010,
GB3836.20-2010

Markings 3051S : Ex ia IIC T4 Ga
3051SF: Ex ia IIC T4 Ga
3051S-ERS: Ex ia IIC T4 G

产品安全使用特殊条件:

- 证书编号后缀“X”表明产品具有安全使用特殊条件:
 1. 产品外壳含有轻金属,用于 0 区时需注意防止由于冲击或摩擦产生的点燃危险.
 2. 当选择 T1 瞬态抑制端子时,此设备不能承受 GB3836.4-2010 标准中第 6.3.12 条规定的 500 V 交流有效值试验电压的介电强度试验.
 3. Transmitter output 为 X 时,天线表面电阻大于 1 GΩ,为了避免静电积聚,不允许用溶剂或者干布擦拭;电源模块表面电阻大于 1 GΩ,如果在危险区域更换,则需要避免静电积聚;只能使用由原制造厂提供的 P/N 753-9220-XXXX 电池.
- 产品使用注意事项:
 1. 产品使用环境温度为:
用于爆炸性气体环境中,产品使用环境温度为: $-60\text{ }^{\circ}\text{C} \leq T_a \leq +70\text{ }^{\circ}\text{C}$
用于爆炸性粉尘环境中,产品使用环境温度为: $-20\text{ }^{\circ}\text{C} \leq T_a \leq +85\text{ }^{\circ}\text{C}$
 2. 本安电气参数:

型号	端子	最高输入电压 U_i (V)	最大输入电流 I_i (mA)	最大输入功率 P_i (W)	最大内部等效参数	
					C_i (nF)	L_i (μH)
3051SA L_C	+, -, CAN	30	300	1	12	0
3051SA L_C... M7/M8 /M9	+, -	30	300	1	12	60
3051SA L, 3051SA M	+, -, CAN	30	300	1	12	33

型号	端子	最高输入电压 U_i (V)	最大输入电流 I_i (mA)	最大输入功率 P_i (W)	最大内部等效参数	
					C_i (nF)	L_i (μ H)
3051SA L... M7/M8 /M9 3051SA M... M7/M8 /M9	+, -	30	300	1	12	93

变送器输出	端子	最高输入电压 U_i (V)	最大输入电流 I_i (mA)	最大输入功率 P_i (W)	最大内部等效参数	
					C_i (nF)	L_i (μ H)
Super module	+, -, CAN	30	300	1	30	0
A	+, -, CAN	30	300	1	12	0
A 配 M7, M8 或 M9 显示	+, -	30	300	1	12	60
F	+, -	30	300	1.3	0	0
FISCO	+, -	17.5	380	5.32	0	0
RTD 选项	-	5	500	0.63	-	-

注: 本安电气参数符合 GB3836.19-2010 对 FISCO 现场仪表的参数要求。

- 选择 Remote Mount 选项 M7, M8, M9 时, 电缆分布电容小于 24nF, 分布电感小于 60 μ H。
- 该产品必须与已通过防爆认证的关联设备配套共同组成本安防爆系统方可使用于爆炸性气体环境。其系统接线必须同时遵守本产品 and 所配关联设备的使用说明书要求, 接线端子不得接错。
- 用户不得自行更换该产品的零部件, 应会同产品制造商共同解决运行中出现的故障, 以杜绝损坏现象的发生。
- 用于爆炸性粉尘环境中, 电缆引入口须选用国家指定的防爆检验机构按检验认可, 具有 Ex tD A20 IP66 防爆等级的电缆引入装置或堵封件, 冗余电缆引入口须用堵封件有效密封。

7. 产品的安装, 使用和维护应同时遵守产品使用说明书, GB3836.13-2013 “爆炸性环境 第 13 部分: 设备的修理, 检修, 修复和改造”, GB3836.15-2000 “爆炸性气体环境用电气设备 第 15 部分: 危险场所电气安装 (煤矿除外)”, GB3836.16-2006 “爆炸性气体环境用电气设备 第 16 部分: 电气装置的检查和维护 (煤矿除外)”, GB3836.18-2010 “爆炸性环境 第 18 部分: 本质安全系统” 和 GB50257-2014 “电气装置安装工程爆炸和火灾危险环境电力装置施工及验收规范” 和 GB15577-2007 “粉尘防爆安全规程”, GB12476.2-2010 “可燃性粉尘环境用电气设备第 2 部分”: 选型和安装的有关规定。

7.6.3 N3 China Type n

Certificate 3051S, 3051SHP: GYJ23.1241X
3051SFx: GYJ23.1245X

Markings Ex ec IIC T5 Gc

产品安全使用特殊条件

- 产品防爆合格证号后缀 “X” 代表产品安全使用有特殊条件: 产品选用瞬态保护端子板 (c 中包含 T1 选项) 时, 设备不能承受 500V 对地电压试验 1 分钟, 安装时需考虑在内。
- 产品使用注意事项
 1. 产品使用环境温度范围为: $-40\text{ }^{\circ}\text{C} \leq T_a \leq +85\text{ }^{\circ}\text{C}$ 。
 2. 最高输入电压: 45 V。
 3. 现场安装时, 电缆引入口须选用经国家指定的防爆检验机构检验认可的, 具有 Ex eIIC Gb 或 Ex nA IIC Gc 防爆等级的电缆引入装置或堵封件, 冗余电缆引入口须用堵封件有效密封。
 4. 安装现场确认无可燃性气体存在时方可维修。
 5. 用户不得自行更换该产品的零部件, 应会同产品制造商共同解决运行中出现的故障, 以杜绝损坏现象的发生。
 6. 产品的安装, 使用和维护应同时遵守产品使用说明书, GB3836.13-2013 “爆炸性环境 第 13 部分: 设备的修理, 检修, 修复和改造”, GB3836.15-2000 “爆炸性气体环境用电气设备 第 15 部分: 危险场所电气安装 (煤矿除外)”, GB3836.16-2006 “爆炸性气体环境用电气设备 第 16 部分: 电气装置的检查和维护 (煤矿除外)”, GB50257-2014 “电气装置安装工程爆炸和火灾危险环境电力装置施工及验收规范” 的有关规定。

7.7 Technical Regulation Custom Union (EAC)

7.7.1 EM EAC Flameproof and Dust Ignition-proof

Certificate EAЭC KZ 7500525.01.01.00672

Markings 0/1 Ex db IIC T6...T4 Ga/Gb X
Ex ta IIIC T105 °C T₅₀₀95 °C Da X

7.7.2 IM EAC Intrinsic Safety

Certificate EAЭC KZ 7500525.01.01.00672
Markings 0Ex ia IIC T4 Ga X

7.7.3 IN EAC Intrinsic Safety

Certificate: EAЭC KZ 7500525.01.01.00672
Markings: 0Ex ia IIC T4 Ga X

7.8 Japan

7.8.1 E4 Japan Flameproof

Certificate CML 17JPN1147X
Markings Ex db IIC T6...T4 Ga/Gb

Temperature class	Ambient temperature	Process temperature
T6	-60 to +70 °C	-60 to +70 °C
T5	-60 to +80 °C	-60 to +80 °C
T4	-60 to +80 °C	-60 to +120 °C

Special Conditions for Safe Use:

1. This device contains a thin wall diaphragm less than 1mm thickness that forms a boundary between EPL Ga (process connection) and EPL Gb (all other parts of the equipment). The model code and datasheet are to be consulted for details of the diaphragm material. Installation, maintenance, and use shall consider the environmental conditions to which the diaphragm will be subjected. The manufacturer’s instructions for installation and maintenance shall be followed in detail to assure safety during its expected lifetime.
2. Flameproof joints are not intended for repair.
3. Non-standard paint options may cause risk from electrostatic discharge. Avoid installations that could cause electrostatic build-up on painted surfaces, and only clean the painted surfaces with a damp cloth. If paint is ordered through a special option code, contact the manufacturer for more information.

7.9 Republic of Korea

7.9.1 EP Republic of Korea Flameproof

Certificate 19-KA4BO-0913X [Mfg USA], 12-KB4BO-0180X [Mfg USA], 11-KB4BO-0068X [Mfg Singapore]

Markings Ex d IIC T6...T4 Ga/Gb

7.9.2 IP Republic of Korea Intrinsic Safety

Certificate 12-KB4BO-0202X [HART® – Mfg USA], 12-KB4BO-0204X [Fieldbus – Mfg USA], 19-KA4BO-0844X [HART – Mfg USA], 19-KA4BO-0845X [Fieldbus – Mfg USA], 12-KB4BO-0203X [HART – Mfg Singapore], 13-KB4BO-0296X [Fieldbus – Mfg Singapore], 19-KA4BO-0845X [Fieldbus-Mfg USA], 19-KA4BO-0844X [HART- Mfg USA]

Markings Ex ia IIC T4

7.10 Combinations

- K1** Combination of E1, I1, N1, and ND
- K2** Combination of E2 and I2
- K5** Combination of E5 and I5
- K6** Combination of E6 and I6
- K7** Combination of E7, I7, and N7
- KA** Combination of E1, I1, E6, and I6
- KB** Combination of E5, I5, E6, and I6
- KC** Combination of E1, I1, E5, and I5
- KD** Combination of E1, I1, E5, I5, E6, and I6
- KG** Combination of IA, IE, IF, and IG
- KM** Combination of EM and IM
- KP** Combination of EP and IP

7.11 Additional certifications

7.11.1 SBS American Bureau of Shipping (ABS) Type Approval

Certificate 17-RJ1679518-PDA

Intended Use Measure gauge or absolute pressure of liquid, gas or vapor applications on ABS classed vessels, marine, and offshore installations.

7.11.2 SBV Bureau Veritas (BV) Type Approval

Certificate 31910 BV

Requirements Bureau Veritas Rules for the Classification of Steel Ships

Application Class Notations: AUT-UMS, AUT-CCS, AUT-PORT and AUT-IMS.

7.11.3 SDN Det Norske Veritas (DNV) Type Approval

Certificate TAA00000K9

Intended Use Det Norske Veritas' Rules for Classification of Ships, High Speed & Light Craft, and Det Norske Veritas' Offshore Standards

Application

Location classes	
Type	3051S
Temperature	D
Humidity	B
Vibration	A
EMC	A
Enclosure	D/IP66/IP68

7.11.4 SLL Lloyds Register (LR) Type Approval

Certificate LR21173788TA

Application Environmental categories ENV1, ENV2, ENV3, and ENV5

7.11.5 D3 Custody Transfer - Measurement Canada Accuracy Approval [3051S Only]

Certificate AG-0501, AV-2380C

7.12 Y3 ATEX/IECEX RFID tag approvals

Certificate	IECEX EPS 15.0042X, EPS 15 ATEX 1 1011 X
Markings	II 2G Ex ia IIC T6/T4 Gb, II 2D Ex ia IIC T80/T130C Db

Conditions of certification

Maximum operating temperature: -58 °F (-50 °C) to +158 °F (+70 °C)

The RFID tags shall never be exposed to high electromagnetic field strengths according to IEC 60079-14.

Electrostatic charges shall be avoided. The tags shall never be used next to strong charge generating processes.

⚠ WARNING

Additional warnings

The plastic enclosure may present a potential electrostatic ignition hazard.

RFID tag has limitations in ambient temperature and zone installation areas (Zones 1 & 21) as compared to the gauge.

8 Declaration of Conformity



EMERSON. EU Declaration of Conformity

No: RMD 1044 Rev. AH



We,

Rosemount Inc.
6021 Innovation Blvd.
Shakopee, MN 55379
USA

declare under our sole responsibility that the product,

Rosemount 3051S Series Pressure Transmitters
Rosmeount 3051SFx Series Flowmeter Transmitters
Rosemount 300S Housings

manufactured by,

Rosemount Inc.
6021 Innovation Blvd.
Shakopee, MN 55379
USA

to which this declaration relates, is in conformity with the provisions of the European Union Directives, including the latest amendments, as shown in the attached schedule.

Assumption of conformity is based on the application of the harmonized standards and, when applicable or required, a European Union notified body certification, as shown in the attached schedule.





(signature)

Mark Lee
(name - printed)

Vice President of Global Quality
(function name - printed)

September 8, 2021
(date of issue)

Page 1 of 4

 **EMERSON. EU Declaration of Conformity** 

No: RMD 1044 Rev. AH

EMC Directive (2014/30/EU)

Harmonized Standards:
EN 61326-1:2013, EN 61326-2-3:2013

PED Directive (2014/68/EU)

Rosemount 3051S Series Pressure Transmitters

Rosemount 3051S_CA4; 3051S_CD2, 3, 4, 5 (also with P0 & P9 option) Pressure Transmitters
QS Certificate of Assessment – Certificate No. 12698-2018-CE-USA-ACCREDIA
Module H Conformity Assessment



All other Rosemount 3051S Pressure Transmitters
Sound Engineering Practice

Transmitter Attachments: Diaphragm Seal, Process Flange, or Manifold
Sound Engineering Practice

Rosemount 3051SFx Series Flowmeter Pressure Transmitters
See DSI 1000 Declaration of Conformity

Page 2 of 4

	EMERSON. EU Declaration of Conformity	
No: RMD 1044 Rev. AH		
ATEX Directive (2014/34/EU)		
BAS01ATEX1303X – Intrinsic Safety Certificate		
Equipment Group II, Category 1 G Ex ia IIC T4 Ga Harmonized Standards Used: EN IEC 60079-0:2018, EN 60079-11:2012		
BAS01ATEX3304X – Type n Certificate		
Equipment Group II, Category 3 G Ex nA IIC T5 Gc Harmonized Standards Used: EN IEC 60079-0:2018, EN 60079-15:2010		
BAS01ATEX1374X – Dust Certificate		
Equipment Group II, Category 1 D Ex ta IIIC T105°C T ₅₀₀ 95°C Da Harmonized Standards Used: EN 60079-0:2012+A11:2013 Other Standards Used: EN 60079-31:2009 (a review against EN 60079-31:2014, which is harmonized, shows no significant changes relevant to this equipment so EN 60079-31:2009 continues to represent "State of the Art") (A review against EN IEC 60079-0:2018 which is harmonized, shows no significant changes relevant to this equipment so EN60079-0:2012 + A11:2013 continues to represent "State of the Art".)		
BAS04ATEX0181X – Mining Certificate		
Equipment Group I, Category M1 Ex ia I Ma Harmonized Standards Used: EN IEC 60079-0:2018, EN 60079-11:2012		
Baseefa05ATEX0193U – Mining Component Certificate		
Equipment Group I, Category M1 Ex ia I Ma Harmonized Standards Used: EN IEC 60079-0:2018, EN 60079-11:2012		
Page 3 of 4		

 **EMERSON. EU Declaration of Conformity** 

No: RMD 1044 Rev. AH

ATEX Directive (2014/34/EU (Continued))

KEMA00ATEX2143X – Flameproof Certificate
Equipment Group II, Category 1/2 G
Ex db IIC T6...T4 Ga/Gb
Harmonized Standards:
EN IEC 60079-0:2018, EN 60079-1:2014, EN 60079-26:2015

PED Notified Body

DNV GL Business Assurance Italia S.r.l. [Notified Body Number: 0496]
Via Energy Park, 14, N-20871
Vimercate (MB), Italy

ATEX Notified Bodies for EU Type Examination Certificate

DEKRA Certification B.V. [Notified Body Number: 0344]
Utrechtseweg 310
Postbus 5185
6802 ED Arnhem
Netherlands

SGS FIMKO OY [Notified Body Number: 0598]
Takomotie 8
FI-00380 Helsinki,
Finland

ATEX Notified Body for Quality Assurance

SGS FIMKO OY [Notified Body Number: 0598]
Takomotie 8
FI-00380 Helsinki,
Finland

Page 4 of 4

9 China RoHS

含有China RoHS管控物质超过最大浓度限值的部件型号列表 Rosemount 3051S
List of Rosemount 3051S Parts with China RoHS Concentration above MCVs

部件名称 Part Name	有害物质 / Hazardous Substances					
	铅 Lead (Pb)	汞 Mercury (Hg)	镉 Cadmium (Cd)	六价铬 Hexavalent Chromium (Cr +6)	多溴联苯 Polybrominated biphenyls (PBB)	多溴联苯醚 Polybrominated diphenyl ethers (PBDE)
电子组件 Electronics Assembly	X	O	O	O	O	O
壳体组件 Housing Assembly	X	O	O	X	O	O
传感器组件 Sensor Assembly	X	O	O	X	O	O

本表格系依据SJ/T11364的规定而制作。

This table is proposed in accordance with the provision of SJ/T11364.

O: 意为该部件的所有均质材料中该有害物质的含量均低于GB/T 26572所规定的限量要求。

O: Indicate that said hazardous substance in all of the homogeneous materials for this part is below the limit requirement of GB/T 26572.

X: 意为在该部件所使用的所有均质材料里，至少有一类均质材料中该有害物质的含量高于GB/T 26572所规定的限量要求。

X: Indicate that said hazardous substance contained in at least one of the homogeneous materials used for this part is above the limit requirement of GB/T 26572.



Quick Start Guide
00825-0100-4805, Rev. GB
November 2024

For more information: [Emerson.com/global](https://www.emerson.com/global)

©2024 Emerson. All rights reserved.

Emerson Terms and Conditions of Sale are available upon request. The Emerson logo is a trademark and service mark of Emerson Electric Co. Rosemount is a mark of one of the Emerson family of companies. All other marks are the property of their respective owners.

ROSEMOUNT™

