

Emerson DeltaV™ Smart Switches

- New and Improved HW and SW platform with more focus on Security and improved performance
- Completely managed by DeltaV™ systems
- Network alerts and diagnostics automatically reported to DeltaV workstations
- Can be installed on the network between the DeltaV workstations and the Emerson Smart Firewall (DeltaV 2.5 network)
- Plug-and-play installation
- Auto security lockdown
- A full line of Industrial Rated Fanless Switches
- Fully supported by Emerson



DeltaV™ Switches provide plug-and-play industrial switches with enhanced security features.

Introduction

The new DeltaV™ Network “Smart” switches are the next generation in the use of commercial off-the-shelf (COTS) components in control systems. Called “purpose-built” commercial components, these switches combine the lower cost of off-the-shelf components with DeltaV specific software and features to make them more integrated and plug-and-play in the DeltaV Area Control Network (ACN) and other DeltaV networks external to the ACN.

DeltaV Smart Switches require no configuration to function in the DeltaV networks. Accessing the advanced features takes only minor configuration that is easy to perform using the DeltaV Network Device Command Center to ensure all smart switches on the network are configured consistently and securely you can’t incorrectly configure any switching functions that impact the performance of the DeltaV system.

This purpose-built switch allows the DeltaV system to provide an auto port lockdown advanced security feature that is easy for a control system user to implement: an increasingly important product feature in today’s hostile environment.

The DeltaV Smart Switches are also pre-configured to detect certain man-in-the-middle attacks using features included in the latest firmware versions such as: ARP spoofing detection and enhanced port lockdown algorithms.

Benefits

Enhanced Security. The next generation of DeltaV Smart Switches is based on a more powerful hardware and software platform with increased focus on security. The new hardware uses powerful CPUs used for Control Plane and Management operation. The software comes with a lot of new features such as role-based access, secure User and Password Management, brute-force attack protection, audit trail and user-readable Event-Log. There is also a new HTML5 Web interface that can be accessed through the Network Device Command Center for easy upgrades to the switch firmware. The next-gen switches also allow for more flexibility with configuration options.

Improved Performance. The switching ASICs used in these new products are providing new capabilities like increased network buffers, capabilities to process/forward/filter packets on more than just L2 address information (e.g. IP addresses, UDP or TCP ports) and also a non-blocking architecture in addition to more powerful CPUs are used for Control Plane and Management operation.

Completely Managed by DeltaV. Power up the switch and it is automatically discovered by the DeltaV switch commissioning application in the Network Device Command Center (formerly the Smart Switch Command Center). The network address is automatically assigned by DeltaV DCS or by the user when installed in the DeltaV 2.5 network (new in DeltaV v13.3). Just provide a switch name, description, and select a few setup parameters and the switch begins reporting. *No more serial connections are required to configure switches.*

Network alerts and diagnostics automatically reported to DeltaV workstations. Operators and maintenance stations will automatically receive device alerts indicating network communications irregularities. The DeltaV Network Device Command Center application provides the interface to diagnose and troubleshoot network problems. *All built-in without the need for third party applications for network monitoring.*

Plug-and-play installation. Next gen DeltaV Smart Switches are configured with DeltaV-compatible settings so that they can be installed into a compatible DeltaV network right out of the box.

They require no user configuration to fully support DeltaV network communications. NDCC ensures all smart switches on the network are configured consistently and you never have to worry about a misconfigured switch impacting network performance. Plug-and-play requires any existing switches or network devices to be configured to communicate in 100/1000 full duplex or to auto-negotiate. See the compatibility sections in this document for details.

Auto lockdown prevents unauthorized network connections. Disabling unused network connections is a security “best practice” and helps you comply with plant security policies. With the one-click lockdown capability built into the switch, you can automatically lock all unused network ports in the system with a single button click in the DeltaV Network Device Command Center application. *Easy to secure the network from intrusions.* The port lockdown algorithm has been enhanced to allow locking of multiple daisy-chained DeltaV nodes, as well as detecting new nodes within the dynamically determined uplink ports. You can also configure the switch to

ignore the lockdown command on specific switch ports if that is required on your application, for e.g., ports connected to the virtualization hosts servers to allow for DeltaV VMs to move between different hosts machines.

Access to console. This is provided using USB-C cable, for Secure Shell (SSH) and serial connections (except for RM2040). The advanced configuration menu includes a limited amount of settings that allow you to customize the switches for your specific use case and yet comply with the DeltaV Area Control Network requirements. The SSH communication provides a secure connection to the switch’s console. Encryption in SSH communications provides extra security for the operation, and maintenance of the switches by protecting user credentials and preventing interceptions.

Full range of switch hardware configurations. The next generation of DeltaV network switches are available in a variety of hardware solutions. From a 30-port rack-mounted unit to fixed-port DIN rail mounted switches, the DeltaV network switch will meet a wide variety of network requirements. *The broad line of DeltaV Smart Switches are all you need to implement a complete DeltaV control network.*

Fully supported by Emerson. As Emerson products, these DeltaV Network Switches are completely supported by Emerson when used within the DeltaV network. You receive full technical support from our Global Service Center, warranty support, product support, and education — all from Emerson.

Product Description

The DeltaV network “smart” switch is a Fast-Ethernet and Gigabit ethernet Layer 2 network switching device. The switch is available in two variations.



The VE6072, VE6073, VE6075 and VE6076 DeltaV Smart Switches: 19” rack-mountable 10 or 26 port modular switch with wired and fiber connections and 30 fixed port gigabit switch (all ports in the **VE6075** and **VE6076** switch are gigabit).



The VE6075 and VE6076 DeltaV Smart Switches: 19" rack-mountable 30 port switch with options for 24 RJ45 wired and 6 fiber connections or 16 RJ45 wired and 14 fiber connections available. All ports are gigabit.



The VE6071 DeltaV Smart Switch: a DIN-rail switch with options for eight 10/100 Mbps and up to four fiber ports that support single mode and multimode fiber connections. Available in standard and extended temperature/conformal-coated versions.

Typical Network Examples using DeltaV Smart Switches

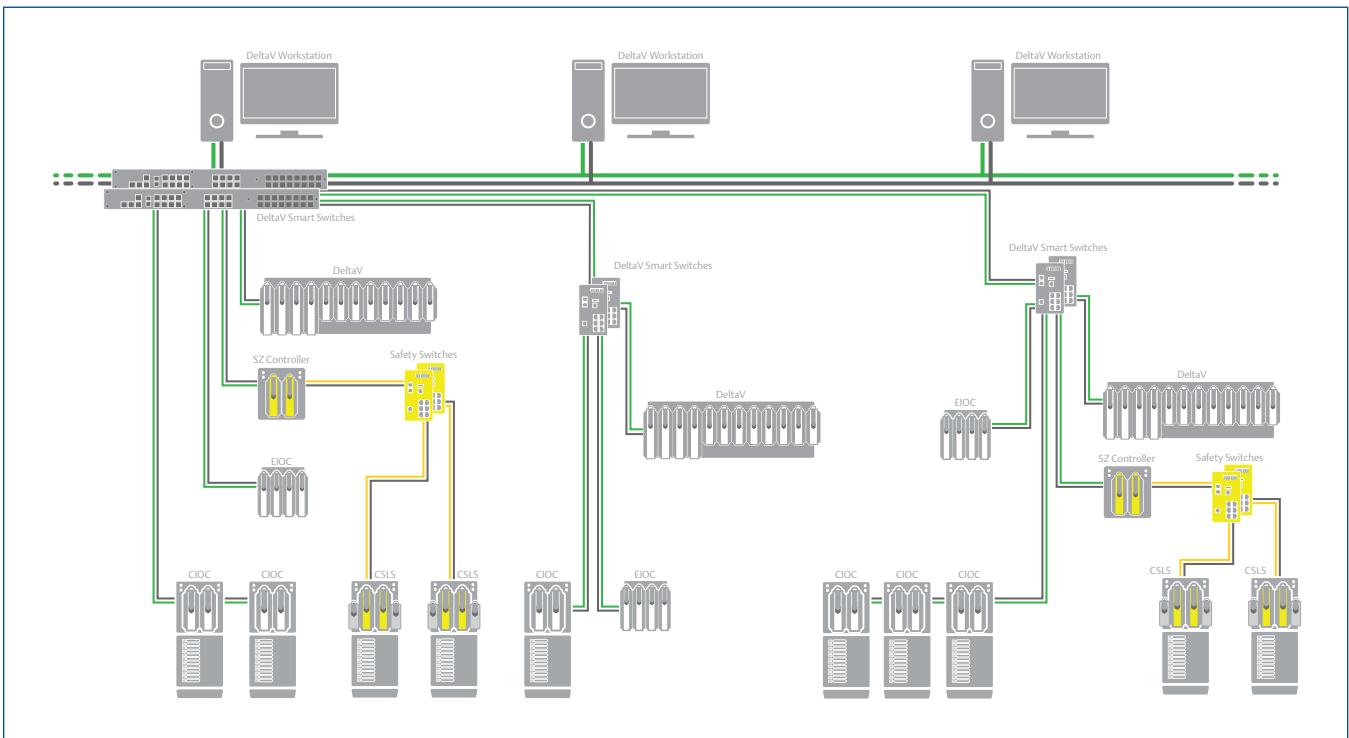

Typical network implementation would use the **VE6075** or **VE6076** as a central switch located in a rack room where AC power is available with the **VE6071** as a field-mounted switch for controllers in field-mounted locations. If required as part of the network architecture, multiple VE6072 and VE6073 switches can be interconnected using the gigabit ports to provide a network backbone to connect devices or other DeltaV switches. The **VE6072** or **VE6073** can also be used as a central switch for smaller system where you do not have the requirement for multiple gigabit ports.

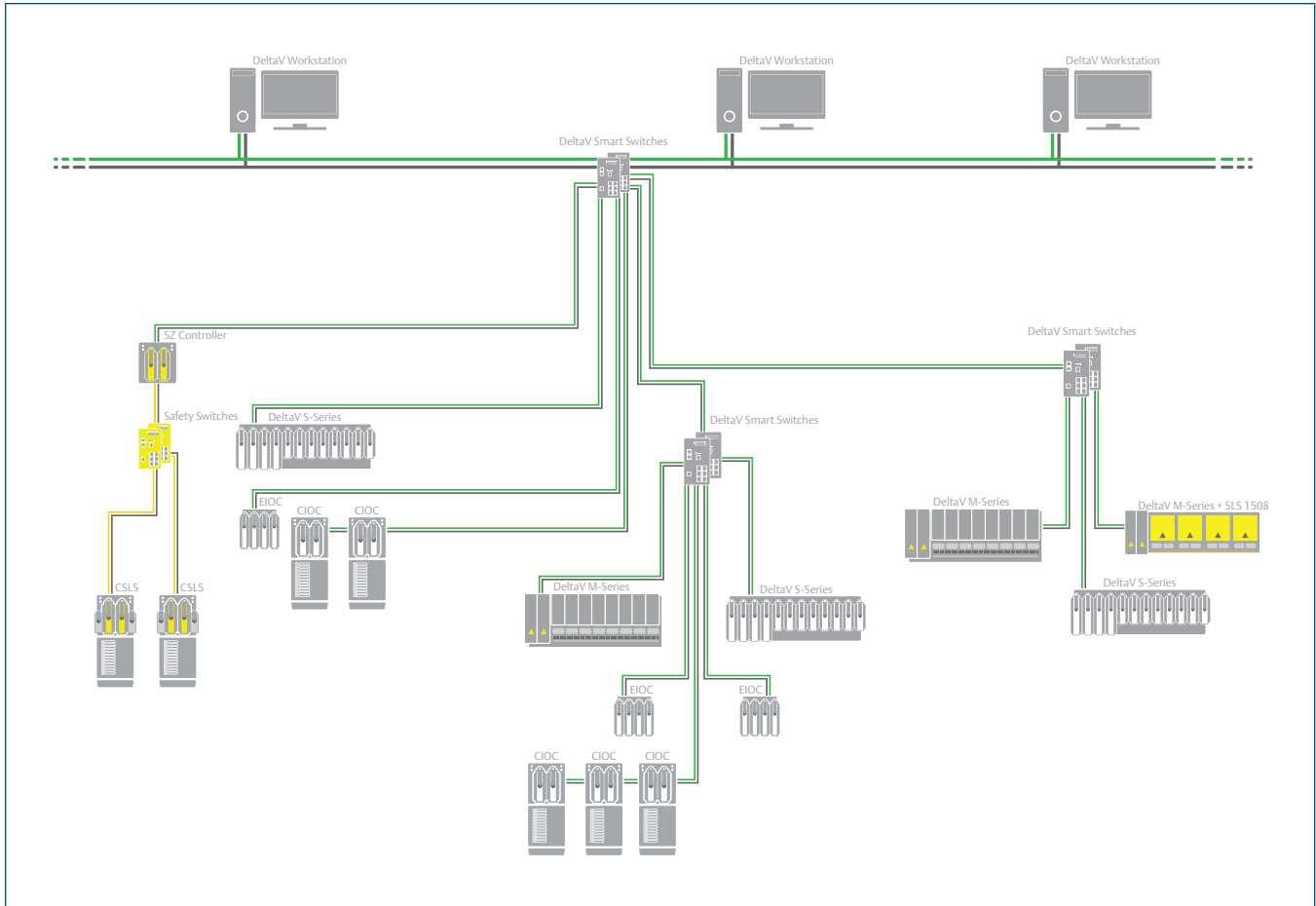

The **VE6071F06C1/C2** can also be used as a central switch if a more modular switch solution is required or to meet extended environment specifications due to the location of the central switch.

Starting in v13.3 the DeltaV Smart Switches can be installed in the DeltaV 2.5 network (and other DeltaV networks external to the DeltaV control network) and managed from the DeltaV Operator Workstation using the DeltaV Network Device Command Center. In this network the Smart Switch is managed only by the DeltaV Network Device Command Center as it is in the DeltaV ACN.

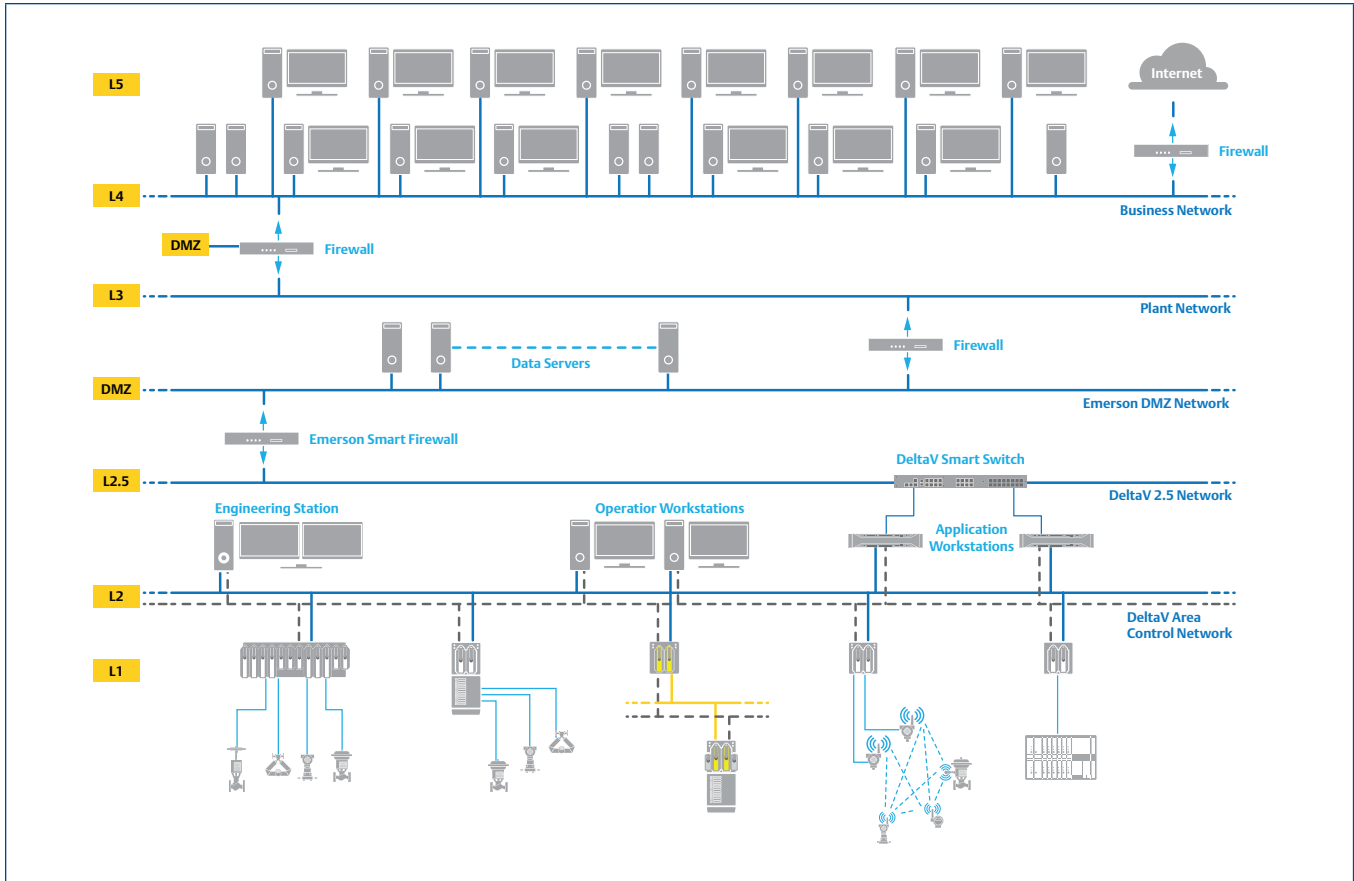

DeltaV reference architecture showing network segmentation and use of DeltaV Smart Switches in the 2.5 network.

When the Smart Switch is installed in the network between the DeltaV workstations and the Emerson Smart Firewall or (other perimeter firewall) it can be locked down to protect this network from unauthorized network connections.

DeltaV Network Device Command Center

The DeltaV Network Device Command Center is a DeltaV application that provides full integration of the DeltaV Smart Switches into the DeltaV and the DeltaV 2.5 networks. The Command Center is used to perform switch commissioning to create the communication between the DeltaV network and the switch management application. The Network Device Command Center provides access to the switch and network diagnostics, device alert details, and port lockdown applications. The management application provides a centralized application to commission, diagnose, troubleshoot, and secure the DeltaV Smart Switches. The Command Center can be viewed by any DeltaV user.

The ability to commission and lock switches is limited to the Can Configure, and Can Download user privileges. Starting in DeltaV v13.3 the DeltaV Smart Switch can be installed in the DeltaV 2.5 network or other DeltaV networks external to the DeltaV control network. For the DeltaV Smart Switch to be installed in a network the switch must be connected to a DeltaV workstation (for example, Professional Plus) running control modules.

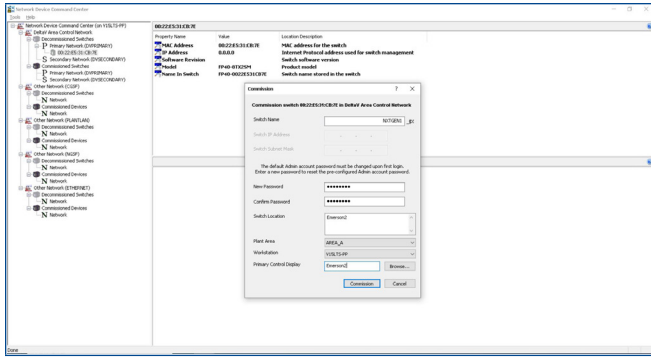

The Network Device Command Center switch commissioning will automatically assign a network address to the switch so the switch can send PlantWeb alerts to DeltaV workstations.

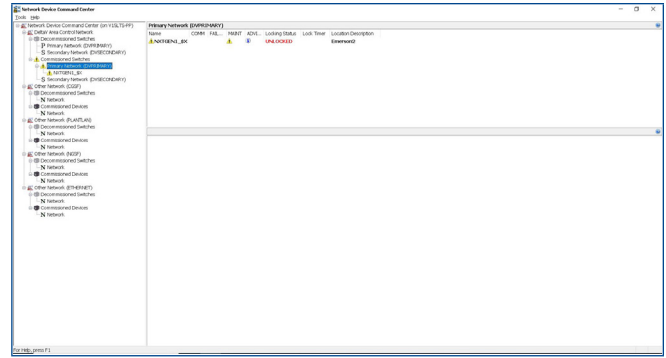

The Network Device Command Center provides an overview of the switch status information including any device or network alerts and the switch security lockdown status.

DeltaV Plug-and-Play Installation

The DeltaV switches are easy to install in your DeltaV network. Since they come preconfigured from the factory, installation is as simple as mounting the unit, connecting the communications cables, and powering up the unit. The switch is configured to begin communications on power up – no additional setup is required for the switching function to work properly. *This immediately returns the system to full redundancy capability as quickly as possible with no time wasted configuring the switch prior to installation.*

NextGen Smart Switch Commissioning

Commissioning is done from a DeltaV workstation after the switch is placed in service. Commissioning the switches after they are installed creates the interface between DeltaV and the switch that gains the full benefit of using the Smart Switch. Commissioning allows the advanced switch setup parameters in the switch to be preconfigured so they only have to be entered once for the system. These parameters only have to be changed if the default settings need to be modified.

Once the commissioning process assigns a network address to the switch it will automatically begin reporting PlantWeb alerts to the workstations. It also allows the Network Device Command Center access to network diagnostics and the one click lockdown security application. *Integration into the DeltaV system eliminates the pre-installation configuration and gets your system back to full strength as quickly as possible.*

Switch and Network Status Alerts

Using standard DeltaV device status reporting, the DeltaV Smart Switches will automatically report the status of both the switch health and network communications problems, such as switch communications failure, switch temperature, and power supply status. In addition, the status of network communications such as excessive packet collisions or excessive dropped packets indicative of network problems, the DeltaV system provides all the network status information without the use of third party Simple Network Management Protocol (SNMP) applications.

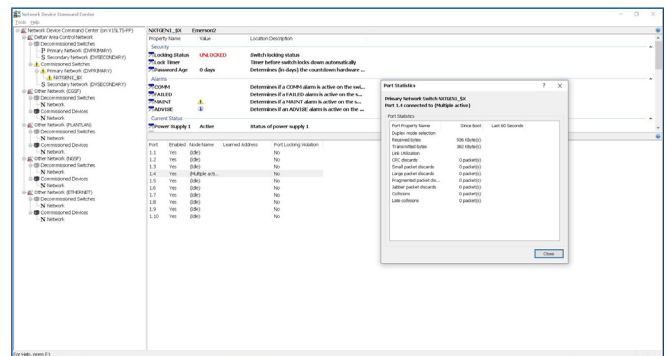

Detailed DeltaV network diagnostics are at your fingertips without the need for 3rd party SNMP applications.

Security Event Reporting DeltaV Smart Switches will report security-related events such as high network traffic that indicates a denial-of-service attack is present and a port -locking violation that indicates an unauthorized device has been connected to a “locked” switch port. Users are notified immediately that a security event has occurred and can take actions to mitigate the attack.

Network Diagnostic Information The Network Device Command Center provides detailed network statistics to help in diagnosing network problems. Information is available on a port-by-port basis so problem communications can be easily isolated. The parameters most commonly used in troubleshooting network issues such as dropped packets are consolidated on a single display and *the information needed is right at your fingertips so troubleshooting the DeltaV network is easy.*

Auto Security Lockdown

The next-gen DeltaV Smart Switches contain auto lockdown security technology to prevent unauthorized access to the network. The DeltaV Network Device Command Center will automatically locate all of the Smart Switches in the network and display their locked or unlocked status. From the Command Center a privileged user can lock or unlock all the switches in the network with a single click. Or they can select a single switch or set of switches to lock or unlock.

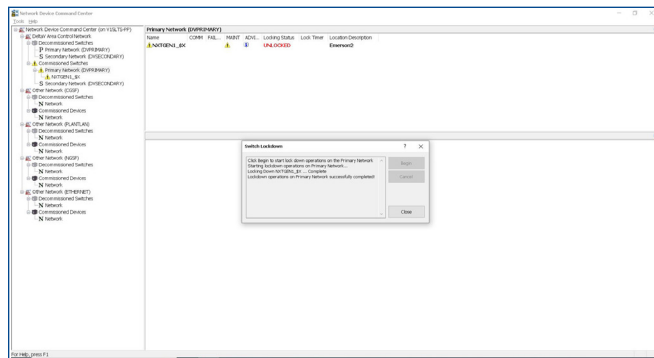

A single click will lock and unlock the switches for maintenance and to add new devices. In addition, the optional lockdown timer will automatically relock switches in 60 minutes to prevent accidentally leaving the switches in an insecure state.

The “lock” command tells the switch to find all of the unused network ports and disable them. It will also memorize what devices are connected on each local port to prevent an existing device from being replaced by an unauthorized rogue device.

Another single click will command all the switches to “unlock,” to add a new device, or to troubleshoot any network problems. The optional 60-minute relock timer will automatically relock all of the switches to prevent the devices from accidentally being left in the insecure, unlocked state.

The Command Center can be run from just the ProfessionalPlus or can also be installed on operator or maintenance stations for easy user access.

All locking and unlocking events are logged in the DeltaV Event Journal so you can easily monitor unlocking events for unusual activity and to be sure proper security procedures are being followed.

System Compatibility

Network Storm Protection Features

Packet rate limiting – the Smart Switch is configured with a fixed-rate-packet limiting setting. The switch rate limiting prevents network communication storms generated from broadcast, multicast, and unknown unicast messages from impacting DeltaV communications by blocking excessive traffic. These types of excess traffic can occur naturally as part of the traffic generated by Ethernet communications. Storm protection is enabled to protect the network during system maintenance activities, redundancy switchovers, and during times when the system is performing routine network activities where excess network traffic is possible.

Network Loop protection – spanning tree protocol is implemented on the next gen Smart Switch to prevent a network loop from creating a network communication storm.

These storm protection features are enabled by default and cannot be disabled or configured. Storm protection is enabled even if the switch is not given an IP address for management.

Important note: Network storm protection and loop protection are available only on managed switches. Therefore, DeltaV control networks using Electronic Marshalling must require a Smart Switch installed between the DeltaV controller and the DeltaV CHARM I/O Card (CIOC).

This network configuration reduces the risk of a network storm disrupting communications and causing the CIOC to go to a fail-safe mode.

Please refer to DeltaV Books-On-Line for more information and requirements for implementing the DeltaV ACN with Electronic Marshalling.

Compatible with previous versions of DeltaV systems

Switches are compatible with existing systems that are installed using the previous generation of DeltaV Smart Switches. Fiber communications of the Smart Switch will only communicate at 100/1000MB full duplex (not configurable) and wired ports will only auto-negotiate Communications.

Existing third-party switches and media converters may not be compatible with the DeltaV Smart Switch as they may not support the required communications. The next-gen Smart Switch will not plug-and-play in some older networks unless the existing devices are set to match the specifications above during the installation.

The auto switch lockdown is compatible only with DeltaV v13.3.1 and later revisions.

Use outside of the DeltaV Control Network

The DeltaV Smart Switches are supported only as an unmanaged switch if installed in networks that cannot be reached by the DeltaV stations running the DeltaV Network Device Command Center. The switch will only accept a management port network address from the DeltaV Network Device Command Center and the switch can only be used where this application is able to access the switch.

As described in Table 1, the DeltaV Smart Switches can be managed if they are used in the DeltaV 2.5 network, the DeltaV Remote Network, or the DeltaV Thin Client Network in DeltaV version 13.3 and higher using the DeltaV Network Device Command Center.

The DeltaV Smart Switches are not available for use as a managed switch in the DeltaV InterZone network as the DeltaV Network Device Command Center cannot access the switch if located on this network.

Note: *Unmanaged switches refer to Smart switches that are not actively being managed through NDCC.*

Port Mirroring

The next-gen DeltaV Smart Switches can be configured to allow ingress data traffic to be forwarded through a probe port to a central switch. This feature allows DeltaV ACN traffic to be monitored as part of the Network Security Monitor solution for DeltaV systems. Additional information is available on the DeltaV Smart Switches Port Mirroring white paper available online.

The RM2040 DeltaV Smart Switch can also be configured to redirect network data traffic when switches have port mirroring enabled. In this case these switches would function as central switches for the mirrored data traffic to reduce the number of connections to the Network Security Monitor appliance.

Please refer to the Network Security Monitor service data sheet and the DeltaV Smart Switches Port Mirroring white paper for additional information.

ARP Spoofing Detection

The next gen DeltaV Smart Switches can detect man-in-the-middle attacks based on Address Resolution Protocol (ARP) poisoning and are able to monitor any type of ARP messages. Although Layer 2 switches, the DeltaV Smart Switches were enhanced to monitor the MAC and IP addresses correlation and alert in case of a mismatch. The alerts are accessible via the switches console connection and can be sent to a Syslog server.

Secure Shell (SSH)

SSH is available on DeltaV Smart Switches to allow secure remote connections to the console for advanced configuration.

SSH provides an encrypted connection for remote access to the DeltaV Smart Switches using DSA 1024-bit or RSA 1024-bit, 2048-bit keys. Please refer to the Guardian Support Portal for additional information about configuration and use of SSH with DeltaV Smart Switches.

Note: *Telnet is disabled by default on all next-gen smart switches*

Product Specifications

The DeltaV Smart Switches are based on hardware produced by a recognized supplier of industrial-grade networking equipment. All switches are fan-less and have simplex and redundant power connections. Some models are also available in high temperature/conformal-coated versions for use in harsh environments. The firmware features are identical in all models of the Next-Gen DeltaV Smart Switch.

The DeltaV Smart Switches are preconfigured for use exclusively within the DeltaV control network or the networks listed in Table 1 below. All switch configuration is performed using the DeltaV Network Device Command Center.

In DeltaV v13.3 and later, the DeltaV Smart Switches can be installed in the DeltaV 2.5 network or other DeltaV networks external to the DeltaV control network (see Table 1).

For the DeltaV Smart Switches to be installed in a network, the switches must be connected to a DeltaV workstation running control modules. It can be installed in the DeltaV virtualization networks only if the network is accessible to a DeltaV workstation (virtual or physical) running control modules. These specific control modules are required to run the DeltaV Network Device Command Center application. DeltaV Operator Workstations are not capable of running these control modules.

The next-gen switches allow for more flexibility with configuration options. The default configuration on the next-gen smart switches has been optimized for DeltaV networks and tested thoroughly. Any configurations outside of the default DeltaV config must be tested in a test environment to prevent any impact on network performance in the production system.

Table 1 - DeltaV Smart Switches Network Compatibility	
DeltaV ACN	Yes
DeltaV 2.5 network	Yes *
DeltaV Remote Network (DeltaV RAS)	Yes *
DeltaV virtualization thin client network	Yes *
DeltaV virtualization host server domain controller network	No
DeltaV Inter-Zone network	No
Plant DMZ and other networks not connected directly to a DeltaV workstation	No

*DeltaV v13.3 and later only requires this network have access to a DeltaV workstation running control modules.

Fiber Optic Cable Specifications – apply to all switch models with fixed SM/MM transceivers

Fiber Optic Cable Types	Specifications
	Specifications apply to all fiber connections on any model of DeltaV Smart Switch <i>Actual fiber optic distances achieved depend on the fiber type used and other components installed on the network such as splices and patch panels that can reduce fiber optic signal strength.</i>
Multimode Fiber (Mm) 50/125 μm	0 – 5000 m, 8 dB link budget at 1310 nm, A = 1 d/km, 3 dB reserve, B = 800 MHz·km
Multimode Fiber (Mm) 62.5/125 μm	0 – 4000 m, 11 dB link budget at 1310 nm, A = 1 dB/km, 3 dB reserve, B = 500MHz·km
Single Mode Fiber (Sm) 9/125 μm	0 – 32.5 km, 16 dB link budget at 1310 nm, A = 0.4dB/km, 3 dB reserve, D = 3.5 ps/(nm·km)

General Specifications for all Next-Gen DeltaV Smart Switches

General Specifications for all Next-Gen DeltaV Smart Switches	
All switches support Fast Ethernet or Gigabit and Fast Ethernet ports – Wire Speed Layer 2 Smart Switch with store-and-forward-switching, Industrial switch fan-less design.	
User Access	<p>The next gen DeltaV Smart switches provide Role Based Access Control where users can assign a role to a user account based on the desired privilege level of that user. More details on User roles and privilege levels can be found in the “Getting Started Guide” available for download on Guardian.</p> <p>Configuration Access based on User Role:</p> <p>All switch configurations are performed using the DeltaV Network Device Command Center applications.</p> <p>Network Device Command Center device and network diagnostic information: Advanced diagnostics are available using the serial interface or web interface. DeltaV Smart Switches can interface to an SNMP application using view-only read/write depending on the role assigned to the user used in SNMP v3 communications.</p>
Network Storm Protection	Packet rate limiting enabled with fixed rate settings, Network Loop protection.
Diagnostics	Front panel LEDs, signal contact in addition to DeltaV Network Device Command Center: DeltaV Smart Switches also support internal log-files and syslog servers.
Setup	No setup is required for switching functions. DeltaV Network Device Command Center application is for diagnostic and alerts.
Security	DeltaV Auto port lockdown, view-only Network Device Command Center for monitoring: All user access is authenticated using local DeltaV user passwords.
Redundancy	Standard DeltaV network redundancy.
Real-Time	Real-time clock–supports NTS as a client.
Port Mirroring	User configurable setting to enable network packets to be mirrored to the Network Security Monitor.
Enhanced Security Settings (ARP spoofing detection and enhanced port lockdown mechanism)	all DeltaV Smart Switches portfolio (there are specific firmware files per switch model type).

Ambient Conditions	VE6071, DIN rail mounted Standard Model ending in C1	VE6071, DIN rail mounted Extended Specs model ending in C2	VE6072, VE6073, Rack Mount switches and VE6074 media modules	VE6075 VE6076 Rack Mount switch
Operating Temperature	0° to +60°C ¹	-40° to +70°C ¹	-10° to +60°C ¹	-10° to +60°C ¹
Storage/Transport Temperature	-40° to +70°C (up to 1 year); -40° to +50°C (up to 2 years); 0°C to +30°C (up to 10 years)			
Relative Humidity (Non-Condensing)	1% to 95%	1% to 95%	10% to 95%	1% to 95%
Conformal-Coated	No	Yes	No	No
Harsh Area Rating	G2	G2 (conformal coating allows switch to be used in G3 environments but switch is not certified to G3)	G2	G2

(1) Please refer to this [white paper](#) to learn more about the effects of heat and airflow inside an enclosure.

Mechanical stability – All switches except as noted:

IEC 60068-2-27 shock 15 g, 11 ms duration, 18 shocks

IEC 60068-2-6 vibration VE6071 DIN rail switches:

5 Hz ... 8,4 Hz with 3,5 mm amplitude; 2 Hz ... 13,2 Hz with 1 mm amplitude; 8,4 Hz ... 200 Hz with 1 g; 13,2 Hz ... 100 Hz with 0,7 g

IEC 60068-2-6 vibration VE6072, VE6073, VE6075 and VE6076 Rack-mount switches:

3.5 mm, 5–8.4 Hz, 10 cycles, 1 octave/min; 1 g, 8.4–150 Hz, 10 cycles, 1 octave/min

EMC emitted immunity

FCC CFR47 Part 15 Class A

EN 55032 Class A

EMC interference immunity VE6071 DIN Rail Switches:

EN 61000-4-2 electrostatic discharge (ESD) 6 kV contact discharge, 8 kV air discharge

EN 61000-4-3 electromagnetic field 10 V/m (80-2000 MHz); 5 V/m (2000-2700 MHz); 3 V/m (5100-6000 MHz)

EN 61000-4-4 fast transients (burst) 2 kV power line, 1 kV data line

EN 61000-4-5 surge voltage power line: 2 kV (line/earth) and 1 kV (line/line); data line: 2 kV data line

EN 61000-4-6 conducted immunity 10 V (150 kHz - 80 MHz)

EMC interference immunity: VE6072 and VE6073 Rack-mount Switches

EN 61000-4-2 electrostatic discharge (ESD) 6 kV contact discharge, 8 kV air discharge

EN 61000-4-3 electromagnetic field 20 V/m (80-2700 MHz), 10V/m (2.7-6 GHz); 1 kHz, 80% AM

EN 61000-4-4 fast transients (burst) 2 kV power line, 2 kV data line

EN 61000-4-5 surge voltage power line: 2 kV (line/earth), 1 kV (line/line); data line: 1kV

EN 61000-4-6 conducted immunity 3 V (10 kHz-150 kHz), 10 V (150 kHz-80 MHz)

EMC interference immunity: VE6075 and VE6076 Rack-mount Switches

EN 61000-4-2 electrostatic discharge (ESD) 6 kV contact discharge, 8 kV air discharge

EN 61000-4-3 electromagnetic field 20 V/m (800-1000 MHz), 10V/m (80-800 MHz ; 1000-6000 MHz); 1 kHz, 80% AM

EN 61000-4-4 fast transients (burst) 2 kV power line, 4 kV data line STP, 2 kV data line UTP

EN 61000-4-5 surge voltage power line: 2 kV (line/earth), 1 kV (line/line); data line: 2 kV

EN 61000-4-6 conducted immunity 10 V (150 kHz – 80 MHz)

General Specifications for the VE6071 DeltaV Smart Switches

Power Requirements

Operating Voltage: 24V – 48V DC, 24 V AC

Power Consumption: 6 W - 9 W (depending on the model)

Mechanical Construction

Dimensions (W x H x D): 73 x 138 x 115 mm (2.87 x 5.43 x 4.52 in)

Mounting: DIN Rail

Weight: 420 g – 570g – depending on the model

Protection Class: IP30



Interfaces

Power supply/signaling contact plug-in terminal block (max. 1 A, 24V DC / 24V AC)

The device provides an USB-C interface for flash upgrades when not using NDCC

- Auto Configuration Adapter ACA22-USB-C (EEC)
- Local Serial connection/Console access to Workstation (with standard USB-A to USB-C cable)
- Local (out-of-band) Ethernet access to Workstation (with standard USB-A to USB-C cable)

One **VE6071** switch with terminal block

NOTE: These switches are described as supporting local ports and uplink ports. Local ports are connected to a single device such as a controller or workstation. An uplink port is connected to another switch. There is no difference in the way the ports function, and a port designated as an “uplink port” can be used as a local port.

General Specifications for the VE6072, VE6073 DeltaV Smart Switches

Up to 26 ports Fast Ethernet/Gigabit Ethernet Industrial Workgroup Switch.



Ports Available:

Base module has 10 ports: 4 combo ports (100/1000 Mbps copper / SFP ports – **VE6050** transceiver modules compatible) and 6 x 10/100 Mbps copper ports in a fixed configuration.

The **VE6073** switch supports expansion media modules (**VE6074**) that can add up to sixteen 10/100 Mbps extra ports. Each media module has eight ports including copper, fiber or SFP ports.

The **VE6072** is not a modular switch and is fixed at twenty-two 10/100 Mbps copper ports and four 100/1000 Mbps combo ports respectively.

Power Requirements

Operating Voltage: 100 - 240V AC, 47 - 63 Hz

Power Consumption: 7.2 W – 11.3 W (Depending on the model)

Mechanical Construction

Dimensions (W x H x D): 448 x 44 x 310 mm (17.64 x 1.73 x 12.20 in) – without mounting bracket

Mounting: 19" control cabinet

Weight: 3.60 – 3.85 kg (depending on the model)

Protection Class: IP20

Interfaces

Power supply/signaling contact plug-in terminal block (max. 1 A, 24V DC/24V AC)





The device provides an USB-C interface for flash upgrades when not using NDCC

- Auto Configuration Adapter ACA22-USB-C (EEC)
- Local Serial connection/Console access to Workstation (with standard USB-A to USB-C cable)
- Local (out-of-band) Ethernet access to Workstation (with standard USB-A to USB-C cable)

One **VE6072** or one **VE6073 switch** with terminal block for signal contact, two brackets with fastening screws (pre-assembled), housing feet - stick-on, and power cable.

NOTES:

- Expansion modules, Fast Ethernet SFP modules, Gigabit Ethernet SFP modules and USB-C cable must be ordered separately.
- When rail mounted, these switches require mounting supports in addition to 10" rail mounting brackets.
- All copper ports can be connected using twisted pair cables with up to 100 meters of length.
- A 1U vacant space above and below the switch is needed when mounting on a 19" rack.
- The built-in SFP module ports for these switches support any combination of **VE6050** transceiver modules
- The **VE6050** gigabit transceiver modules are not compatible with VE6074 expansion modules.
- **VE6072, VE6075, and VE6076** switches do not support stacking. To create a central switch of greater than 24 ports, switches should be interconnected using the front panel (built-in) gigabit ports.

Specifications for VE6074 Expansion Modules				
				
	Specifications for VE6074M01	Specifications for VE6074M02	Specifications for VE6074M03	Specifications for VE6074M04
Length of cable	100 m (max.)	See fiber cable specs	See fiber cable specs	See SFP specs
Power Requirements				including SFP modules
Current Consumption	2 W	10 W	10 W	11 W
Power Output in BTU (IT) h	7	34	34	37
Mechanical Constructions				
Dimensions MM (W x H x D)	138 x 90 x 42mm	138 x 90 x 42mm	138 x 90 x 42mm	138 x 90 x 42 mm
Weight	0.21 Kg	0.18 Kg	0.18 Kg	0.13 Kg (excludes SFP modules)
Protection Class	IP20	IP20	IP20	IP20

The VE6075 and VE6076 All Gigabit DeltaV Smart Switch

The **VE6075 and VE6076** are an all gigabit DeltaV Smart Switch designed to be used as the central switch in a DeltaV network architecture using a star topology. In the star topology this switch would be connected to the gigabit uplink ports of a **VE6072, VE6073 and VE6071F06**, Smart Switch.

When connected to **VE6071** Smart Switches or DeltaV controllers / CIOC / WIOC / EIOC communications will auto-negotiate to 100 Mbps.

When connected to a DeltaV workstation the communications will auto-negotiate to 1 Gbps.

This switch can be also installed in the DeltaV 2.5 network (v13.3 and newer systems only).

The **VE6075 and VE6076** are designed to be the central switch in a star network design and should not be used as a replacement for or in place of the RM200-Series (**VE6072 / VE6073**) within the DeltaV ACN.

NOTE: For the **VE6075 and VE6076** switch to be installed in a network the switch must be connected to a DeltaV workstation running control modules. It can be installed in the DeltaV virtualization networks only if the network is accessible to a DeltaV workstation (virtual or physical) running control modules. These control modules are required to run the DeltaV Network Device Command Center application. DeltaV Operator Workstations are not capable of running these control modules.

General Specifications for the VE6075 and VE6076 DeltaV Smart Switch (RM2040 all Gigabit switch)



30 ports Gigabit Ethernet Industrial Workgroup switch, fan-less design Ports available: 30 ports in total;

VE6075 – 24 x 10/100/1000 Mbps copper ports and 6 x 1000 Mbps SFP ports –

VE6076 – 16 x 10/100/1000 Mbps copper ports and 14 x 1000 Mbps SFP ports –

This switch is not modular – the **VE6074** expansion modules are not used on this switch.

The **VE6050** gigabit transceivers can be used on this switch.

Power Requirements

Operating Voltage: 100 - 240V AC, 47 - 63 Hz

Power Output: 107 BTU (IT) h – without SFP transceiver modules

Power Consumption: 31 W – without SFP transceiver modules

Mechanical Construction

Dimensions: 448 x 320 x 44 mm (17.64 x 12.59 x 1.73 in) – without mounting bracket

Mounting: 19" control cabinet

Weight: 5.1 kg (179 oz)

Protection Class: IP30

Interfaces

Power supply/signaling contact plug-in terminal block (max. 1 A, 24V DC / 24V AC)

USB – C for local serial cable connection/console access to Workstation for flash upgrades (with standard USB-A to USB-C cable).

NOTES:

- Gigabit Ethernet SFP modules, and USB-C cable must be ordered separately.
- When rail mounted, these switches require mounting supports in addition to 10" rail mounting brackets.
- All copper ports can be connected using twisted pair cables with up to 100 meters of length.
- The built-in SFP module ports for these switches support any combination of VE6050 transceiver modules.
- A 1U vacant space above and below the switch is needed when mounting on a 19" rack.
- This switch does not support "stacking." To create a central switch of greater than 30 ports, switches should be interconnected using any of the available gigabit ports.

Provided in VE#

One **VE6075 and VE6076** switch with terminal block for signal contact, two brackets with fastening screws (pre-assembled), housing feet - stick-on, and power cable.

Specifications for 100 Mbps SFP Transceivers 				
LC = Connector Type MM = Multi-Mode SM = Single Mode LH = Long haul	VE6050T08 M-FAST SFP-MM/LC-EEC VE6050T09⁽²⁾ SFP-FAST-MM/LC-EEC 100 Mbps	VE6050T06 M-FAST SFP-SM/LC-EEC VE6050T010⁽²⁾ SFP-FAST-SM/LC-EEC 100 Mbps	VE6050T05 M-FAST SFP-SM+/LC-EEC 100 Mbps	VE6050T04 M-FAST SFP-LH/LC-EEC 100 Mbps
Coupled Power max.	-14 dBm GI 62.5/125	-8 dBm	0 dBm	0 dBm
Coupled Power min.	-20 dBm GI 62.5/125	-15 dBm	-5 dBm	-5 dBm
Center Wavelength	1310 nm	1310 nm	1310 nm	1550 nm
Spectral Width (-20dB)	175 nm FWHM	7.7 nm RMS	3 nm RMS	1 nm
Low Light Threshold	-31 dBm	-28 dBm	-34 dBm	-34 dBm
Maximum Input	-14 dBm	-8 dBm	-10 dBm	-10 dBm
Loss Budget	0-11 dB GI 62.5/125 0-8 dB GI 50/125	0-13 dB	10-29 dB	10-29 dB
Maximum Link Span	0-4 km GI 62.5/125 1.0 dB/km, 500Hz·km 0-5 km GI 50/125 1.0 dB/km, 800MHz·km	0-25 km SI 9/125 0.4 dB/km	25-65 km SI 9/125	47-104 km SI 9/125 0.25 dB/km 55-140 km SI 9/125 0.18 dB/km ⁽¹⁾
<p>Link spans with 3 dB reserve (1) with Corning® Ultra-Low Loss Optical Fiber SMF-28® Actual fiber optic distances achieved greatly depend on the fiber type used and other components installed on the network such as splices and patch panels that can reduce fiber optic signal strength. These modules can be used as follows:</p> <ul style="list-style-type: none"> ■ VE6072, VE6073, and VE6071 switch uplink SFP slots. ■ VE6074M04 expansion module. <p>All transceivers are compatible with both standard and extended specification switch modules. (2) The VE6050T09 and the VE6050T010 SFP transceivers are similar to the VE6050T08 and VE6050T06 respectively, but with different certification options. Please review the certifications table for more information.</p>				

Specifications for 1 Gbps SFP Transceivers 				
LC = Connector Type SX, LX, and LH indicate link distance	VE6050T07 M-SFP-SX/LC EEC 1 Gbps	VE6050T03 M-SFP-LX/LC EEC VE6050T011⁽¹⁾ SFP-GIG-LX/LC EEC 1 Gbps	VE6050T02 M-SFP-LH/LC-EEC 1 Gbps	VE6050T01 M-SFP-LH+/LC 1 Gbps
Coupled Power max.	-4 dBm	-3 dBm	+5 dBm	0 dBm
Coupled Power min.	-9.5 dBm	-9.5 dBm	-2 dBm	+5 dBm
Center Wavelength	850 nm	1310 nm	1550 nm	1550 nm
Spectral Width (-20dB)	0.85 nm RMS	3 nm RMS	1 nm	1 nm
Low Light Threshold	-20 dBm	-20 dBm	-22 dBm	-30 dBm
Maximum Input	0 dBm	-3 dBm	-3 dBm	-10 dBm
Loss Budget	0-7.5 dB	0-10.5 dB	8-20 dB	15-30 dB
Maximum Link Span	0-550 m GI 50/125 3.0 dB/km, 400 MHz·km 0-275 m GI 62.5/125 3.2 dB/km, 200MHz·km	0-550 m GI 50/125 1.0 dB/km, 800 MHz·km 0-550 m GI 62.5/125 1.0 dB/km, 500 MHz·km 0-20 km SI 9/125 0.4 dB/km 2.5 dB reserve	38-68 km 0.25 dB/km	71-108 km 0.25 dB/km 71-128 km 0.21 dB/km
<p>Link spans with 3 dB reserve</p> <p>Actual fiber optic distances achieved greatly depend on the fiber type used and other components installed on the network such as splices and patch panels that can reduce fiber optic signal strength.</p> <p>These modules can be used as follows:</p> <ul style="list-style-type: none"> ■ VE6072, VE6073, VE6071 switch in the uplink SFP slots. ■ VE6075 and VE6076 switches SFP slots. <p>These modules cannot be used in the 100 Mbps slots of the VE6074M04 expansion module.</p> <p>All transceivers except the VE6050T01 are compatible with both standard and extended specification switch Modules. The VE6050T01 does not meet temperature rating of extended specification switches.</p> <p>(1) The VE6050T011 SFP transceiver is similar to the VE6050T03, but with different certification options. Please review the certifications table for more information.</p>				

Certifications

Declaration/Approval	FP40/50 VE6071	FP40/50-ES VE6071	RM200 VE6072 VE6073	RM2040 VE6075 VE6076
CE Declaration – Basic Standards EMC - Harmonized European Standards according to Directive 2014/30/EU <ul style="list-style-type: none"> ■ EN 55022:2010 Class A - Emission of Information Technology Equipment ITE (for industrial use only)¹ ■ EN 55032:2015 Class A - Emission of Multimedia Equipment ME (for industrial use only) ■ EN 61000-6-4:2007+A1:2011 - Electromagnetic compatibility – Emission standard for industrial environments ■ EN 61000-6-2:2005 + IEC CDV 61000-6-2:2015 - Immunity for industrial environments ■ EN 61000-3-2:2014 - Limits for harmonic current emissions ■ EN 61000-3-3:2013 - Limitation of voltage changes, voltage fluctuations and flicker 	Class A	Class A	Class A	Class A
FCC Declaration (USA/Canada) <ul style="list-style-type: none"> ■ 47CFR:2019, Part 15, Subpart B, Class A – Unintentional radiators ■ ICES-003 Issue 6 2017 	Class A	Class A	Class A	Class A
cUL Approval according to UL 61010-1 and UL 61010-2-201 (replaces UL 508) <ul style="list-style-type: none"> ■ UL 61010-1 3rd Edition 2012, Rev. 2015 - Industrial Control Equipment - US. Safety standard UL 61010-2-201 1st Edition 2013 - Particular requirements for control equipment - CSA 22.2 No. 61010-1-12 3rd Edition, Rev. 2015 - ICE - Canadian safety standard	Yes	Yes	N/A	N/A
Hazardous Locations - Approval according to ISA-12.12.01 Class 1 Div. 2, Group A, B, C, D <ul style="list-style-type: none"> ■ ANSI/ISA 12.12.01: 2015 ■ CSA 22.2 No. 213-15: 2015 	Yes	Yes	N/A	No
IEC/EN 61131-2 Environmental and Safety Declaration <ul style="list-style-type: none"> ■ EN 61131-2: 2007 – Programmable Controllers – Environmental Requirements 	Yes	Yes	Yes	Yes
cUL Approval according to UL 62368-1 <ul style="list-style-type: none"> ■ UL 62368-1 2nd Edition 2014 - Information Technology Equipment – US. Safety standard - CSA 22.2 No. 60950-1-07, 2nd Edition, 2014-10 - ITE – Canadian safety standard 	N/A	N/A	Yes	Yes

(1) Applies only to FP40 and FP50 (including -ES)

<p>IEC/EN 62368-1 Safety Declaration</p> <ul style="list-style-type: none"> EN 62368-1:2014 +AC2015 Information technology equipment – Safety Evaluated to national deviations of EU, USA, CA, AUS, NZ, China, Japan <p>Safety of Laser products regulations</p> <ul style="list-style-type: none"> EN 60825-1:2007 – Safety of laser products Class 1 	Yes	Yes	N/A	N/A
<p>Safety - Harmonized European Standards according to Low-Voltage-Directive 2014/35/EU</p> <p>IEC/EN 62368-1 Safety Declaration</p> <ul style="list-style-type: none"> EN 62368-1:2014 +A11:2017 <p>Audio/video, information and communication technology equipment - Safety requirements</p> <p>Evaluated to national deviations of EU</p> <p>Safety of Laser products regulations</p> <ul style="list-style-type: none"> EN 60825-1:2007 – Safety of laser products Class 1 	N/A	N/A	Yes	Yes
<p>IEC/EN 62368-1 CB Test Certificate</p> <ul style="list-style-type: none"> EN 62368-1:2014 +AC2015 – Information technology equipment – Safety <p>Evaluated to national deviations of EU, USA, CA, AUS, NZ, China, Japan</p>	N/A	N/A	Yes	Yes

The **VE6050T09**, **VE6050T010** and **VE6050T011** SFP transceivers cannot be used with FP40/FP50 switches when installed in hazardous areas (Class 1 Div. 2).

Declaration/Approval	FP40/50 VE6071	FP40/50-ES VE6071	RM200 VE6072 VE6073	RM2040 VE6075 VE6076
ATEX Approval, Zone 2 ■ According to Directive 2014/34/EU, IECEx – Certification System - Equipment for use in Explosive Atmospheres	N/A	Yes	N/A	N/A
DNV	No	Yes	Yes	No
Australian Regulatory Compliance Mark (RCM) Australian Radiocommunications Standard 2008, Radiocommunications Act 1992 ■ CISPR 32:2015, Class A - ITE - Radio disturbance characteristics - Limits and methods of measurement	Yes	Yes	Yes	Yes
EAC: Russia, Kazakhstan, Belarus	Yes	Yes	Yes	Yes
UKCA	Yes	Yes	Yes	Yes
UKEX	No	Yes	No	No
CCC Ex	Yes	Yes	No	No
EAC-Ex	No	No	No	No
RoHS - Harmonized European Standards according to Directive 2011/65/EU and 2015/863/EU ■ On the restriction of the use of certain hazardous substances in electrical and electronic equipment	Yes	Yes	Yes	Yes
China ROHS	Yes	Yes	Yes	Yes

The **VE6050T09**, **VE6050T010** and **VE6050T011** SFP transceivers cannot be used with switches when installed in hazardous areas (Zone 2). The same restrictions apply to the certifications: DNV-GL and EAC Ex which are not available for these SFP transceivers.

(2) Only Hardware compliance. No certificate available.

DeltaV Configuration Parameters







The DeltaV Smart Switches are designed to plug-and-play within the DeltaV network without requiring configuration of the switching functions to meet DeltaV requirements. As such all of the switching configuration parameters are preset and no changes are needed.

This table provides a list of the configuration parameters that are user accessible and can be changed using the Network Device Command Center or Command Line Interface. All other switch configuration parameters are pre-configured and the user is strongly advised not to change it.

Parameter	Description
Reset Configuration to DeltaV Defaults	Clears the value of the settings below back to DeltaV default values.
IP Address for the Switch (010.X.x.x)	Network address for the switch to enable DeltaV Smart Switch Command Center access. Entry must be in the range of permitted DeltaV addresses reserved for switches. The DeltaV Smart Switches cannot accept any IP address except those used within the DeltaV network. The subnet mask 255.254.0.0 must be used when the Smart Switch is on the DeltaV Area Control Networks.
Name for Switch [up to 64 Characters]	Name for switch that appears in Network Device Command Center.
Location For Switch [up to 64 Characters]	Physical location description appears in Network Device Command Center.
Change default "Admin" Password	Allows default switch admin password to be changed – Changing this password only impacts user access to the switch and is not connected or synchronized with DeltaV or Windows passwords.
Change Emerson NDCC User Password	Allows the custom Emerson NDCC switch user password to be changed – Password must only be changed through NDCC. The switch Web UI, serial port, or SSH connections must not be used to change the password of this user. Changing this password impacts communications between the NDCC application to the switch and is not connected or synchronized with DeltaV or Windows passwords.
IP Address of SNMP Trap Destination Node	Allows switch to send any preconfigured traps to a computer on the DeltaV network.
IP Address of Syslog Server Node	Allows switch to send to a computer on the DeltaV network that is setup to collect communications traffic information from the switch.
Enable/Disable SSH Access	Enable/Disable remote configuration access using Secure Shell (SSH).
Time Server IP Address	Location to get real time to sync internal clock with system.
Backup Time Server IP Address	Location to get real time to sync internal clock with system if primary time server is unavailable.
Port Mirroring	Configure port mirroring for DeltaV Smart Switches. Users can define which ports will be mirrored as well as which switch port will be used as the probe port.
Enhanced Port Lockdown	You can lock and unlock the switch via the Network Device Command Center. The switch Web UI, SSH, and console connections can be used to choose which ports will be excluded from the switch port lockdown (if needed).
Transfer SSH Encryption Keys	A copy command is available to allow you to transfer SSH encryption keys to the switch. Additional information about SSH and supported encryption keys can be found in the Guardian Support Portal.
Login Banner	Set the text for the pre-login banner displayed on serial, and SSH connections.

Ordering Information

The specifications and DeltaV ordering numbers below provide the information necessary to help design the DeltaV network and order the necessary equipment to implement the network.

VE6071 DeltaV Smart Switches <i>The modules with VE# ending in C2 are extended spec versions of the VE6071 switches and must be used where high temperature or conformal coating is required.</i>	
Description	Model Number
8-ports switch – all 10/100 Mbps copper DeltaV Smart Switch 8x 10/100BASE-TX RJ45 ports (FP40-8TX) Power consumption 6 W Power output in BTU (IT) h 20	 VE6071F01C1 VE6071F01C2
9-ports switch – eight 10/100 Mbps copper and one 100 Mbps multi-mode fiber Smart DeltaV Smart Switch 8x10/100BASE-TX RJ45 ports, 1xMM SC Port (FP40-8TX1MM) Power consumption 7 W Power output in BTU (IT) h 24	 VE6071F02C1 VE6071F02C2
9-ports switch – eight 10/100 Mbps copper and one 100 Mbps single-mode fiber DeltaV Smart Switch 8x10/100BASE-TX RJ45 ports, 1xSM SC Port (FP40-8TX1SM) Power consumption 7 W Power output in BTU (IT) h 24	 VE6071F03C1 VE6071F03C2
10-ports switch – eight 10/100 Mbps copper and two 100 Mbps multi-mode fiber DeltaV Smart Switch 8x10/100BASE-TX RJ45 ports, 2xMM SC Port (FP40-8TX2MM) Power consumption 8 W Power output in BTU (IT) h 27	 VE6071F04C1 VE6071F04C2
10-ports switch – eight 10/100 Mbps copper and two 100 Mbps single-mode fiber DeltaV Smart Switch 8x10/100BASE-TX RJ45 ports, 1xSM SC Port (FP40-8TX2SM) Power consumption 8 W Power output in BTU (IT) h 27	 VE6071F05C1 VE6071F05C2
12-ports switch – eight 10/100 Mbps copper and four 100/1000 Mbps SFP fiber port DeltaV Smart Switch 8x10/100BASE-TX RJ45 ports, 4x100/1000 SFP Fiber Port (FP50-8TX4GSFP) Power consumption 9 W Power output in BTU (IT) h 31	 VE6071F06C1 VE6071F06C2



VE6072 DeltaV Smart Switches

The **VE6072** industrial switch has fixed amount of ports (22 copper ports and 4 combo ports). This switch should be used when a modular rack mount switch is not required. These are lower cost and are not available with redundant power.

Description	Model Number
<p>26-ports switch – 22 x 10/100 Mbps copper and 4 x 100/1000 Mbps copper / SFP combo ports (compatible with VE6050-series transceiver modules) – RM200-22TX/4C</p> <p>Power Requirements Power Output in BTU (IT) h: 38,5 Power Consumption: 11,3 W Weight: 3.85 Kg</p>	 <p>(This switch is not modular)</p>
Smart 26-ports switch – North American power cord	VE6072P1
Smart 26 -ports switch – United Kingdom power cord	VE6072P2
Smart 26-ports switch – European power cord	VE6072P3
Smart 26 -ports switch – Australian power cord	VE6072P4

VE6073 DeltaV Smart Switches



The **VE6073** switch is a base chassis with 6 fixed copper ports and 4 gigabit combo ports. The **VE6074** modules are installed to create the specific switch configuration required.

Description	Model Number
<p>10-ports switch – DeltaV Smart Switch; 19-inch Rack mount modular model with 6x10/100BASE-TX RJ45 ports, 4x100/1000 Combo Ports, 2 Module Slots; Single PSU (compatible with VE6050-series transceiver modules). It also includes two expansion bays to add ports – RM200-Base Module</p> <p>Power Requirements Power Output in BTU (IT) h: 24,6 (without media modules) Power Consumption: 7,2 W (without media modules) Weight: 3.60Kg (without media modules)</p>	 <p>Simplex Power Supply</p>
Smart 10-ports switch – Simplex power supply – North American power cord	VE6073R1P1
Smart 10-ports switch – Simplex power supply – United Kingdom power cord	VE6073R1P2
Smart 10-ports switch – Simplex power supply – European power cord	VE6073R1P3
Smart 10-ports switch – Simplex power supply – Australian power cord	VE6073R1P4
<p>10-ports switch – DeltaV Smart Switch; 19-inch Rack mount modular model with 6x10/100BASE-TX RJ45 ports, 4x100/1000 Combo Ports, 2 Module Slots; Redundant PSU (compatible with VE6050-series transceiver modules). It also includes two expansion bays to add ports – RM200-Base Module</p> <p>Power Requirements Power Output in BTU (IT) h: 26.9 (without media modules) Power Consumption: 7.3 W (without media modules) Weight: 3.60Kg (without media modules)</p>	 <p>Redundant Power Supplies</p>
Smart 10-ports switch – Redundant power supplies – North American power cord	VE6073R2P1
Smart 10-ports switch – Redundant power supplies – United Kingdom power cords	VE6073R2P2
Smart 10-ports switch – Redundant power supplies – European power cords	VE6073R2P3
Smart 10-ports switch – Redundant power supplies – Australian power cords	VE6073R2P4

VE6074 Expansion Modules

8-ports expansion modules for the VE6073 switch

Note: VE6074 Expansion Modules cannot be installed in the VE6072 switches.

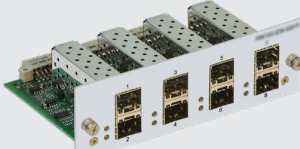
Description	Model Number
<p>8-ports expansion module for VE6073-series smart switches – each port is 10/100 Mbps copper (RM200-EM8TX). See specifications table below. Module is hot swappable</p>	<p>VE6074M01</p> 
<p>8-ports expansion module for VE6073-series smart switches – each port is 100 Mbps multi-mode fiber with SC connector (RM200-EM8MMFX). See specifications table below. Module is hot swappable.</p>	<p>VE6074M02</p> 
<p>8-ports expansion module for VE6073-series smart switches – each port is 100 Mbps single-mode fiber with SC connector (RM200-EM8SMFX). See specifications table below. Module is hot swappable.</p>	<p>VE6074M03</p> 
<p>8-slots expansion module for VE6073-series smart switches – the slots can have any combination of VE6050-series 100 Mbps transceiver modules installed (RM200-EM8SFP). See specifications table below. Module and SFP transceiver modules are hot swappable.</p>	<p>VE6074M04</p> 

VE6075 and VE6076 DeltaV Smart Switches

The **VE6075 and VE6076** switch is an All-Gigabit smart switch with 30 gigabit ports.

The **VE6050** transceivers can be considered to enable fiber connectivity for this switch.

Description	Model Number
<p>-30 ports switch – 24 x 10/100/1000 Mbps copper and 6 x 1000 Mbps SFP ports (compatible with VE6050-series gigabit transceiver modules). - RM2040-24TX/6SFP</p> <p>Power Requirements Power Output in BTU (IT) h: 107 (without SFP) Power Consumption: 31 W (without SFP) Weight: 5.1Kg (without SFP)</p>	 <p>Redundant Power Supply</p>
Smart 30-ports switch – North American power cord	VE6075P1
Smart 30-ports switch – United Kingdom power cord	VE6075P2
Smart 30-ports switch – European power cord	VE6075P3
Smart 30-ports switch – Australian power cord	VE6075P4

Description	Model Number
<p>-30 ports switch – 16 x 10/100/1000 Mbps copper and 14 x 1000 Mbps SFP ports (compatible with VE6050-series transceiver modules). RM2040-16TX/14SFP</p> <p>Power Requirements Power Output in BTU (IT) h: 107 (without SFP) Power Consumption: 31 W (without SFP) Weight: 5.1Kg (without SFP)</p>	 <p>Redundant Power Supply</p>
Smart 30-ports switch – North American power cord	VE6076P1
Smart 30-ports switch – United Kingdom power cord	VE6076P2
Smart 30-ports switch – European power cord	VE6076P3
Smart 30-ports switch – Australian power cord	VE6076P4

Fiber Optic SFP Transceivers for use in DeltaV Smart Switches

The Gigabit transceivers can be used only in the gigabit ports of the **VE6071, VE6072, VE6073, VE6075** and **VE6076**.

The 100 Mbps transceiver modules can be used in the SFP ports of the **VE6071, VE6072, VE6073** switches, and the **VE6074** SFP expansion module of the **VE6073** switch.







All transceiver modules except the **VE6050T01** are compatible with the extended specification switches and can also be used in the standard specification switches as well.





The transceivers **VE6050T09, VE6050T010** and **VE6050T011** cannot be used when certain certifications are required such as: ISA-12.12-01 (Class 1 Div. 2), ATEX Zone 2, DNV-GL, KCC, EN 50121-4, EN61850-3/IEEE1613. Please review the certifications section of this product data sheet for more information.

Power consumption for all transceiver modules: Operating voltage power supply through the switch.

- Power Consumption: 1 W
- Weight: 40g

NOTE: DeltaV Smart Switches must use the transceiver modules indicated below. The switches are not compatible with other brands of transceiver modules. Cisco transceiver modules are not compatible with DeltaV Smart Switches.

Description	Model Number
<p>Transceiver module for Smart Switches: 1 Gbps Ethernet; single-mode long haul, for up to 120 Kilometers of fiber optic cable (M-SFP-LH+/LC).</p> <p>NOTE: This SFP Module is not compatible with extended specification usage – not available with extended temperature specifications.</p>	<p>VE6050T01 Gigabit</p> 
<p>Transceiver module for Smart Switches: 1 Gbps Ethernet; single-mode long haul, for up to 80 Kilometers of fiber optic cable (M-SFP-LH/LC-EEC) – extended specifications.</p>	<p>VE6050T02 Gigabit</p> 
<p>Transceiver module for Smart Switches: 1 Gbps Ethernet; single-mode, for up to 20 Kilometers of fiber optic cable (M-SFP-LX/LC EEC) – extended specifications.</p>	<p>VE6050T03 Gigabit</p> 
<p>Transceiver module for Smart Switches: 1 Gbps Ethernet; multi-mode, for up to 550 meters of fiber optic cable (M-SFP-SX/LC EEC) – extended specifications.</p>	<p>VE6050T07 Gigabit</p> 
<p>Transceiver module for Smart Switches: 1 Gbps Ethernet; single-mode, for up to 20 Kilometers of fiber optic cable (SFP-GIG-LX/LC EEC) – extended specifications.</p>	<p>VE6050T011 Gigabit</p> 
<p>Transceiver module for Smart Switches: 100 Mbps Ethernet; single-mode, for up to 100 Kilometers of fiber optic cable (M-FAST SFP-LH/LC-EEC) – extended specifications.</p>	<p>VE6050T04</p> 
<p>Transceiver module for Smart Switches: 100 Mbps Ethernet; single-mode, for up to 65 Kilometers of fiber optic cable (M-FAST SFP-SM+/LC-EEC) – extended specifications.</p>	<p>VE6050T05</p> 

<p>Transceiver module for Smart Switches: 100 Mbps Ethernet; single-mode, for up to 25 Kilometers of fiber optic cable (M-FAST SFP-SM/LC-EEC) – extended specifications.</p>	<p>VE6050T06</p> 
<p>Transceiver module for Smart Switches: 100 Mbps Ethernet; multi-mode, for up to 5 Kilometers of fiber optic cable (M-FAST SFP-MM/LC-EEC) – extended specifications.</p>	<p>VE6050T08</p> 
<p>Transceiver module for Smart Switches: 100 Mbps Ethernet; multi-mode, for up to 5 Kilometers of fiber optic cable (SFP-FAST-MM/LC EEC) – extended specifications.</p>	<p>VE6050T09</p> 
<p>Transceiver module for Smart Switches: 100 Mbps Ethernet; single-mode, for up to 25 Kilometers of fiber optic cable (SFP-FAST-SM/LC EEC) – extended specifications.</p>	<p>VE6050T010</p> 

DeltaV Smart Switch Accessories

Description	Model Number
<p>Rack-mount kit for DIN-rail mounted Smart Switches: Allows VE6071 switches to be mounted on standard 19” rails.</p> <p>NOTE: Switches not included. Picture shown with VE6041 switches installed.</p> <p>Installation rack for 19” cabinet 4U high.</p> <p>Dimensions [WxHxD]: 481mm (18.94in) - usable 435mm (17.13in) x 177mm (9.67in) x 275mm (10.83in).</p> <p>DIN Rail variable in height and depth adjustable. 10mm (0.39in) increments.</p>	<p>KJ1611X1-JA1</p> 

©2023, Emerson. All rights reserved.

The Emerson logo is a trademark and service mark of Emerson Electric Co. The DeltaV logo is a mark of one of the Emerson family of companies. All other marks are the property of their respective owners.

The contents of this publication are presented for informational purposes only, and while diligent efforts were made to ensure their accuracy, they are not to be construed as warranties or guarantees, express or implied, regarding the products or services described herein or their use or applicability. All sales are governed by our terms and conditions, which are available on request. We reserve the right to modify or improve the designs or specifications of our products at any time without notice.

Contact Us
www.emerson.com/contactus