

Ensure protection of liquid assets, tanks and the environment



FISHER™ Tank blanketing solutions

The challenge of pressure control in tanks

Everyday your facility is challenged to control hazardous risks from liquid and vapor products changing pressures in storage tanks. Normal and unexpected operating conditions, along with varying atmospheric temperatures, are persistently changing pressures within your tanks. Without accurately controlling the pressures, toxic venting to the atmosphere or inbreathing of air moisture that will jeopardize the integrity of the stored product will occur.

Proven Fisher™ technology for tank blanketing

Emerson offers a broad Fisher product portfolio of fit-for-purpose tank blanketing regulators that can help mitigate risks associated with normal and unexpected pressure changes in storage tanks. With **very low setpoint technology and balanced designs**, Fisher Tank Blanketing regulators provide **superior pressure control**, all while helping to **reduce blanketing costs** through accuracy and reliability.

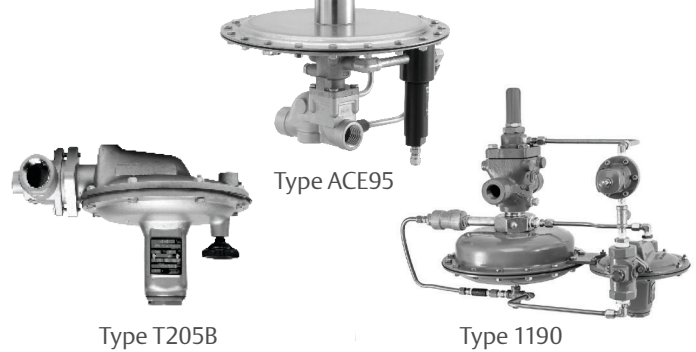

Why Tank Blanketing?

- Prevent air moisture and other contaminants from entering the tank
- Achieve better compliance with clean air regulations
- Reduce gas and product losses due to overpressure and evaporation
- Maintain tank integrity by preventing vacuum conditions





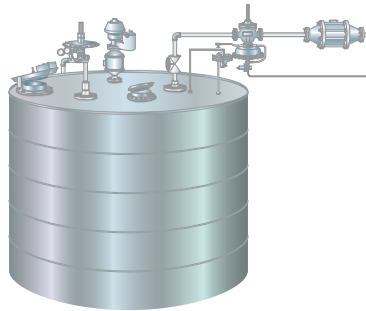

Ensure protection of liquid assets, tanks and the environment

Fisher™ tank blanketing regulators help **efficiently maintain a protective environment above any liquid stored in a tank or vessel** when the liquid is being pumped out or experiences temperature changes. These solutions optimize a tank's pressure ecosystem when paired with Fisher vapor recovery regulators, or Enardo™ emergency vents, valves and flame arrestors.



Ask About Us

-  Wireless monitoring
-  Sour Gas / NACE construction
-  Hygienic materials
-  Arctic Temp. construction

Featured pilot regulator solutions

ACE95 Series

Precisely control blanketing gas at a low setpoint without inlet sensitivity

- Stainless Steel construction
- Diagnostic port for in-line or remote analysis
- Easy installation and maintenance
- Type ACE95Jr available for reduced flow applications

Optional single array manifold (SAM) sense line/ main valve connection through a single tank nozzle.

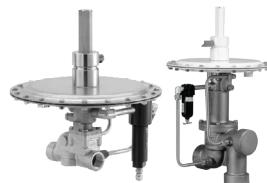

Type ACE95 Type ACE95SR

Body Sizes	NPS 3/4, 1, 1 x 2 and 2 / DN 20, 25, 25 x 50 and 50
Control Pressure Range	-5 in. w.c. to 1.5 psig / -12 mbar to 0.10 bar
Max Flow	499,600 SCFH / 13,390 Nm ³ /h of Nitrogen

Type 1190

High-capacity blanketing with very accurate pressure control

- On-tank or at-grade installation options
- Valve travel indicator wireless or manual monitoring
- Top-entry design for easy in-line maintenance

Quick-change trim packages available for fast replacements



Body Sizes	NPS 1, 2, 3, 4, 6, 8 x 6 and 12 x 6 / DN 25, 50, 80, 100, 150, 200 x 150 and 300 x 150
Control Pressure Range	0.25 in. w.c. to 7 psig / 0.6 mbar to 0.48 bar
Max Flow	2,811,000 SCFH / 75,335 Nm ³ /h of Nitrogen

Featured self-operated regulator solutions

T205 Series

Low pressure design with fast speed of response with low lockup pressure.



Body Sizes	NPS 3/4 and 1 / DN 20 and 25
Control Pressure Range	1 in. w.c. to 7 psig / 2.5mbar to 0.48 bar
Max Flow	24,399 SCFH / 654 Nm ³ /h of Air

T205 Balanced Regulator

Fully balance plug design to reduce inlet pressure sensitivity.



Body Sizes	NPS 3/4 and 1 / DN 20 and 25
Control Pressure Range	1 in. w.c. to 7 psig / 2.5mbar to 0.48 bar
Max Flow	19,101 SCFH / 512 Nm ³ /h of Air

Y692 / Y693 Series

Rugged and reliable pressure control of very low pressures.



Body Sizes	NPS 1-1/2 and 2 / DN 40 and 50
Control Pressure Range	0.5 in.w.c. to 10 psig / 1.2 mbar to 0.69 bar
Max Flow	Y692: 17,757 SCFH / 358 Nm ³ /h of Air Y693: 26,296 SCFH / 716 Nm ³ /h of Air

Emerson Automation Solutions

Americas

T +1 800 558 5853
T +1 972 548 3574

 webadmin.regulators@emerson.com

 Fisher.com

Europe

T +39 051 419 0611

 [Facebook.com/EmersonAutomationSolutions](https://www.facebook.com/EmersonAutomationSolutions)

Asia Pacific

T +65 6777 8211

 [LinkedIn.com/company/emerson-automation-solutions](https://www.linkedin.com/company/emerson-automation-solutions)

 [Twitter.com/emr_automation](https://twitter.com/emr_automation)

Middle East / Africa

T +971 4811 8100