



EMERSON[™]

Original Instructions
4000867 - REV. 00



DCX HD

Power Supply

Instruction Manual

Branson Ultrasonics Corp.
120 Park Ridge Road
Brookfield, CT 06084
(203) 796-0400
<http://www.bransonultrasonics.com>

BRANSON

Manual Change Information

At Branson, we strive to maintain our position as the leader in ultrasonics plastics joining, metal welding, cleaning and related technologies by continually improving our circuits and components in our equipment. These improvements are incorporated as soon as they are developed and thoroughly tested.

Information concerning any improvements will be added to the appropriate technical documentation at its next revision and printing. Therefore, when requesting service assistance for specific units, note the Revision information found on this document, and refer to the printing date which appears on this page.

Copyright and Trademark Notice

Copyright © 2022 Branson Ultrasonics Corporation. All rights reserved. Contents of this publication may not be reproduced in any form without the written permission of Branson Ultrasonics Corporation.

Mylar is a registered trademark of DuPont Teijin Films.

Loctite is a registered trademark of Loctite Corporation, Newington, CT.

WD-40 is a registered trademark of WD-40 Manufacturing Company.

Windows 7, Windows Vista, and Windows XP are registered trademarks of Microsoft Corporation

Other trademarks and service marks mentioned herein are held by their respective owners.

Foreword

Congratulations on your choice of a Branson Ultrasonics Corporation system!

The Branson DCX HD Power Supply system is process equipment for the joining of plastic parts using ultrasonic energy. It is the newest generation of product using this sophisticated technology for a variety of customer applications. This Instruction Manual is part of the documentation set for this system, and should be kept with the equipment.

Thank you for choosing Branson!

Introduction

This manual is arranged into several structured chapters which will help you find the information you may need to know to safely handle, install, set up, program, operate, and/or maintain this product. Please refer to the [Table Of Contents](#) and/or the [Index](#) of this manual to find the information you may be looking for. In the event you require additional assistance or information, please contact our Product Support department (see [1.3 How to Contact Branson](#) for information on how to contact them) or your local Branson representative.



Table Of Contents

Chapter 1: Safety and Support

1.1	Safety Requirements and Warnings	2
1.2	General Precautions	4
1.3	How to Contact Branson	6

Chapter 2: Introduction

2.1	Models Covered	12
2.2	Compatibility with other Branson Products	15
2.3	Features	16
2.4	Controls and Indicators	18
2.5	Welding Systems	21
2.6	Glossary	22

Chapter 3: Delivery and Handling

3.1	Shipping and Handling	26
3.2	Receiving	27
3.3	Unpacking the Power Supply	28
3.4	Take Inventory of Small Parts	29
3.5	Returning Equipment	30

Chapter 4: Technical Specifications

4.1	Technical Specifications	32
4.2	Physical Description	34

Chapter 5: Installation and Setup

5.1	About Installation	36
5.2	Installation Requirements	37
5.3	Installation Steps	43
5.4	Power Supply Configuration	54
5.5	Assembling the Acoustic Stack	55
5.6	Converter Cooling	59
5.7	Testing the Installation	60
5.8	Still Need Help?	61

Chapter 6: Operation

6.1	Activating Ultrasonic Power	64
6.2	Setting the Amplitude	65
6.3	Resetting the Power Supply Alarms	67
6.4	Configuring the Power Supply Registers	68
6.5	LCD Bar Graph	72
6.6	Web Page Interface	75
6.7	Ultrasonics Test Procedure	80

Chapter 7: Maintenance

7.1	General Maintenance Considerations	84
7.2	DCX HD Power Supply Preventive Maintenance	86
7.3	Calibration	91
7.4	Recommended Spare Stock	92
7.5	Troubleshooting	96

7.6	Cold Start Procedure	100
Appendix A: Signal Diagrams		
A.1	Signal Diagrams	102

List Of Figures

Chapter 1: Safety and Support

Figure 1.1	Safety-related Labels found on the DCX S-Series Power Supply (Horizontal)	3
Figure 1.2	Safety-related Labels found on the DCX S-Series Power Supply (Vertical)	3

Chapter 2: Introduction

Figure 2.1	The DCX HD Power Supply (Horizontal)	12
Figure 2.2	The DCX HD Power Supply (Vertical)	13
Figure 2.3	DCX HD Power Supply Front Panel Controls and Indicators	18
Figure 2.4	LCD Description	19
Figure 2.5	DCX HD Power Supply Back Panel (Horizontal)	20
Figure 2.6	DCX HD Power Supply Bottom Panel (Vertical)	20

Chapter 3: Delivery and Handling

Chapter 4: Technical Specifications

Chapter 5: Installation and Setup

Figure 5.1	DCX HD Power Supply Benchtop Dimensional Drawing	38
Figure 5.2	DCX HD Power Supply Vertical Mount Dimensional Drawing (800 W)	39
Figure 5.3	DCX HD Power Supply Vertical Mount Dimensional Drawing (1.5 kW)	40
Figure 5.4	DCX HD Power Supply Vertical Mount Dimensional Drawing (4 kW)	41
Figure 5.5	LCD Viewing Angle	45
Figure 5.6	DCX HD Power Supply Connections (Horizontal Model)	45
Figure 5.7	DCX HD Power Supply Connections (Vertical Model)	46
Figure 5.8	User I/O Cable Identification and Wire Color Diagram	47
Figure 5.9	Typical Digital I/O Wiring Examples	51
Figure 5.10	Typical Analog I/O Wiring Examples	51
Figure 5.11	RF Cable Connection	52
Figure 5.12	Assembling the Acoustic Stack	56
Figure 5.13	Connecting Tip to Horn	58

Chapter 6: Operation

Figure 6.1	LCD at Power Up	65
Figure 6.2	LCD when in External Amplitude Control Mode	66
Figure 6.3	Frequency Bar Graph Interpretation Examples	74
Figure 6.4	Test Connections	82

Chapter 7: Maintenance

Figure 7.1	Reconditioning Stack Mating Surfaces	88
------------	--------------------------------------	----

Appendix A: Signal Diagrams

Figure A.1	Continuous	102
Figure A.2	Continuous, Overload Error	103

List Of Tables

Chapter 1: Safety and Support

Table 1.1	Authorized Service Center (North America)	6
Table 1.2	Authorized Service Centers (South America)	6
Table 1.3	Authorized Service Centers (Asia)	6
Table 1.4	Authorized Service Centers (Europe)	8

Chapter 2: Introduction

Table 2.1	Models Covered in this manual	12
Table 2.2	Power Supply Compatibility with Branson Converters	15
Table 2.3	DCX HD Power Supply Front Panel Controls and Indicators	18
Table 2.4	LCD Description	19
Table 2.5	Connections to the DCX HD Power Supply	20

Chapter 3: Delivery and Handling

Table 3.1	Shipping Specifications	26
Table 3.2	Inspect the power supply	27
Table 3.3	Unpacking the power supply	28
Table 3.4	Small Parts included (=x): Power Supply Assemblies	29
Table 3.5	DCX HD Power Supply System Cables	29

Chapter 4: Technical Specifications

Table 4.1	Environmental Specifications	32
Table 4.2	Electrical Input Operating Voltages	32
Table 4.3	Input Current and Circuit Breaker Specifications	32
Table 4.4	Continuous Duty Max. Power	33
Table 4.5	Dimensions and Weights of DCX HD Power Supply	34

Chapter 5: Installation and Setup

Table 5.1	Environmental Requirements	42
Table 5.2	Input Current and Circuit Breaker Specifications	42
Table 5.3	User I/O Cable Pin assignments	47
Table 5.4	Default User I/O Connector Pin Assignments	48
Table 5.5	Available Digital Input Functions	49
Table 5.6	Available Digital Output Functions	49
Table 5.7	Available Analog Input Functions	50
Table 5.8	Available Analog Output Functions	50
Table 5.9	RF Cable Connection	52
Table 5.10	Input Power Connection	53
Table 5.11	Acoustic Stack Description	56
Table 5.12	Stack Torque Values	56
Table 5.13	Tools	57
Table 5.14	20 kHz System	57
Table 5.15	30 kHz System	57
Table 5.16	40 kHz System	58
Table 5.17	Tip to horn torque values	58
Table 5.18	Continuous Duty Max. Power & Full Power Duty Cycle	59
Table 5.19	Converter Cooling Procedure	59

Chapter 6: Operation

Table 6.1	Setting the Amplitude Using the Front Panel Controls	65
Table 6.2	Resetting the DCX HD Power Supply	67
Table 6.3	Steps to configure the Power Supply Registers	68
Table 6.4	Registers	69
Table 6.6	Frequency Bar-Graph Interpretation - 30 kHz (76 Hz Segment)	73
Table 6.7	Frequency Bar-Graph Interpretation - 40 kHz (100 Hz/Segment)	73
Table 6.5	Frequency Bar-Graph Interpretation - 20 kHz (50 Hz Segment)	73
Table 6.8	Power Supply Ultrasonic Test Procedure (Front Panel)	80
Table 6.9	Power Supply Ultrasonic Test Procedure (User I/O)	81
Table 6.10	Power Supply Ultrasonic Test Procedure (Web Page Interface)	82

Chapter 7: Maintenance

Table 7.1	Stack Reconditioning Procedure	87
Table 7.2	Reconditioning Stack Mating Surfaces	88
Table 7.3	Stack Torque Values	88
Table 7.4	Stack Reassembly for a 20 kHz System	89
Table 7.5	Stack Reassembly for a 30 kHz System	89
Table 7.6	Stack Reassembly for a 40 kHz System	90
Table 7.7	Stud Torque Values	90
Table 7.8	DCX HD Power Supply System Cables	92
Table 7.9	Suggested Spares	92
Table 7.10	Converters Compatible with the DCX HD Power Supply	93
Table 7.11	DCX HD Power Supply Compatible Boosters	93
Table 7.12	Other Items used with the DCX HD Power Supply	95
Table 7.13	Troubleshooting	96
Table 7.14	Troubleshooting Common Electrical Problems	96
Table 7.15	Troubleshooting Fan/Power Switch Problems	97
Table 7.16	Troubleshooting Ultrasonic Power Problems	97
Table 7.17	Troubleshooting Weld Cycle Problems	99
Table 7.18	Steps to Perform a Cold Start	100

Appendix A: Signal Diagrams

Chapter 1: Safety and Support



1.1	Safety Requirements and Warnings	2
1.2	General Precautions	4
1.3	How to Contact Branson	6

1.1 Safety Requirements and Warnings

This chapter contains an explanation of the different Safety Notice symbols and icons found both in this manual and on the product itself and provides additional safety information for ultrasonic welding. This chapter also describes how to contact Branson for assistance.

1.1.1 Symbols Found in this Manual

Three symbols used throughout this manual warrant special attention:

WARNING	General Warning
	<p>Warning indicates a hazardous situation or practice which, if not avoided, can result in serious injury or death.</p>
CAUTION	General Warning
	<p>Caution indicates a hazardous situation which, if not avoided, could result in minor or moderate injury. It can also alert the user to unsafe practices or conditions that can damage equipment if not corrected.</p>
NOTICE	
	<p>Notice contains important information. It does not alert the user to potential injury, but only to a situation that might eventually require additional work or modification if you ignore it initially.</p>

1.1.2 Symbols Found on the Product

The DCX HD Power Supply has several safety-related labels on it to indicate the presence of hazardous voltages inside the unit.

Figure 1.1 Safety-related Labels found on the DCX S-Series Power Supply (Horizontal)



Figure 1.2 Safety-related Labels found on the DCX S-Series Power Supply (Vertical)



1.2 General Precautions

Take the following precautions before servicing the power supply:

- Be sure the power switch is in the off position before making any electrical connections
- To prevent the possibility of an electrical shock, always plug the power supply into a grounded power source
- To prevent the possibility of an electrical shock, ground the power supply by securing an 8 gage grounded conductor to the ground screw located next to the air outlet
- Power supplies produce high voltage. Before working on the power supply assembly, do the following:
 - Turn off the power supply
 - Unplug main power
 - Allow at least 5 minutes for capacitors to discharge
- High voltage is present in the power supply. Do not operate with the cover removed
- High line voltages exist in the ultrasonic power supply assembly. Common points are tied to circuit reference, not chassis ground. Therefore, use only non-grounded, battery-powered multimeters when testing the power supply assembly. Using other types of test equipment can present a shock hazard
- Keep hands from under the horn. Down force (pressure) and ultrasonic vibrations can cause injury
- Do not cycle the welding system if either the RF cable or converter is disconnected
- When using larger horns, avoid situations where fingers could be pinched between the horn and the fixture

CAUTION	Loud Noise Hazard
	<p>Sound level and frequency of the noise emitted during the ultrasonic assembly process may depend upon a. type of application, b. size, shape and composition of the material being assembled, c. shape and material of the holding fixture, d. welder setup parameters and e. tool design.</p> <p>Some parts vibrate at an audible frequency during the process. Some or all of these factors may result in an uncomfortable noise being emitted during the process.</p> <p>In such cases operators may need to be provided with personal protective equipment. See 29 CFR (Code of Federal Regulations) 1910.95 Occupational Noise Exposure.</p>

1.2.1 Intended Use of the System

The DCX HD Power Supply and components are designed to be used as part of an ultrasonic welding system. These are designed for a wide variety of welding or processing applications.

1.2.2 Emissions

When being processed, certain plastic materials can emit toxic fumes, gases or other emissions that can be hazardous to the operator's health. Where such materials are

processed, proper ventilation of the workstation is required. Check your materials suppliers for recommended protection when processing their materials.

CAUTION	Corrosive Material Hazard
	Processing of many materials, such as PVC, can be hazardous to an operator's health and could cause corrosion/damage to the equipment. Use proper ventilation and take protective measures.

1.2.3 Setting up the Workplace

Measures for setting up a workplace for safe operation of the ultrasonic welder are outlined in [Chapter 5: Installation and Setup](#)

1.2.4 Regulatory Compliance

This product meets electrical safety requirements and EMC (Electromagnetic Compliance) requirements for North America and the European Union.

1.3 How to Contact Branson

Branson is here to help you. We appreciate your business and are interested in helping you successfully use our products. To contact Branson for help, use the following telephone numbers, or contact the office nearest you.

1.3.1 Authorized Service Center (North America)

Table 1.1 Authorized Service Center (North America)

Name	Address	Tel/Fax Number
Branson Ultrasonics Corp. Global Headquarters United States	120 Park Ridge Road Brookfield, CT 06804	Tel: 1-203-796-0400 Fax: 1-203-796-0593 info@bransonultrasonics.com

1.3.2 Authorized Service Centers (South America)

Table 1.2 Authorized Service Centers (South America)

Name	Address	Tel/Fax Number
Intersonic Argentina	Av. Cramer 2361 1C Buenos Aires 1428	Tel: 011-54-11-4781-2327 Fax: 011-54-11-4782-2412
Branson do Brasil Brasil	Rua Goiatuba, 81 06465-300 – Barueri / SP	Tel: 55-11-4208-1652

1.3.3 Authorized Service Centers (Asia)

Table 1.3 Authorized Service Centers (Asia)

Name	Address	Tel/Fax Number
Branson Ultrasonics (Shanghai) Co. Ltd. – China Headquarters China	528 Rong Le Dong Road, Song Jiang Song Jiang Industry Zone CN-Shanghai, 201613 PRC	Tel: 86-21-3781-0588 Fax: 86-21-5774-5100 c.service@emerson.com
Branson Ultrasonics Co. Ltd. Beijing Office	Room 216, Flat B, 12 Hong Da North Road, Chuangxin Technological Mansion Beijing Department Area. Beijing 100176 PRC	Tel: 86-10-6787-7806 Fax: 86-10-6787-3378
Branson Ultrasonics Co. Ltd. Tianjin Office		Tel: 86-22-2732-5233 Fax: 86-22-2732-3581

Table 1.3 Authorized Service Centers (Asia)

Name	Address	Tel/Fax Number
Branson Ultrasonics Co. Ltd. Dongguan Office		Tel: 86-769-8541-0736 Fax: 86-769-8541-0735
Branson Ultrasonics Co. Ltd. Suzhou Office		Tel: 86-512-6295-3652 Fax: 86-512-6295-3651
Branson Ultrasonics Asia Pacific Co. Ltd. Hong Kong Office	Flat A, 5/F Pioneer Building 213 Wai Yip Street, Kwung Tong Kowloon, Hong Kong	Tel: 852-2790-3393 Fax: 852-2341-2716 info@emerson.com
Branson Ultrasonics Div. of Emerson Electric Co. P. Ltd. "Ajanta House" India	8/35, Marol Co-Op Industrial Estate M.V. Road, Andheri (East) Mumbai 400 059, India	Tel: 91-22-2850-5570 Fax: 91-22-2850-8681
Branson Ultrasonics Japan Headquarters Division of Emerson Japan Ltd.	4-3-14 Okada, Atsugi-Shi Kanagawa 243-0021 Japan	Tel: 81-46-228-2881 Fax: 81-46-288-8892
Branson Korea Co., Ltd. Korea	#803, 8F Dongil Techno Town 823, Kwan Yang-2dong, Dong An-gu An Yang-si, Kyung Ki-do, 431-062 Korea	Tel: 82-1577-0631 Fax: 82-31-422-9572
Branson Ultrasonics Div. of Emerson Elec (M) Sdn Bhd. Malaysia	No. 20, Jalan Rajawali 3, Puchong Jaya Industrial Park Batu 8, Jalang Puchong 47170 Puchong, Selangor Malaysia	Tel: 603-8076-8608 Fax: 603-8076-8302
Branson Ultrasonics Philippines	Emerson Building 104 Laguna Blvd. Laguna Technopark Inc. Sta. Rosa, Laguna, 4026 Philippines	Tel: 63-49-502-8860 Fax: 63-49-502-8860 Mobile: 63-917-5372072
Branson Ultrasonics Singapore	10 Pandan Crescent #03-06 UE Tech Park LL3 Singapore 128466	Tel: 65-6891-7600 Fax: 65-6873-7882

Table 1.3 Authorized Service Centers (Asia)

Name	Address	Tel/Fax Number
Branson Ultraschall Taiwan	Div. of Emerson Electric (Taiwan) Co. Ltd. 5F-3, No. 1, Wu-Chiuan First Road Wu-Ku Ind Zone, Hsin- Chuang City Taipei Hsien 24892, Taiwan	Tel: 886-2-2298-0828 Fax: 886-2-2298-9985
Emerson Limited Thailand	662/39-40 Rama 3 Road Bangpongpan, Yannawa Bangkok 10120, Thailand	Tel: 66-2-293-01217 Fax: 66-2-293-0129

1.3.4 Authorized Service Centers (Europe)

Table 1.4 Authorized Service Centers (Europe)

Name	Address	Tel/Fax Number
Branson Ultraschall Czech Republic		Tel: 420-374-625-620 Fax: 420-374-625-617
Branson Ultrasons France	1 Rue des Pyrenees Silic 404 94573 Rungis Cedex France	Tel: 33-1-4180-2550 Fax: 33-1-4687-8729
Branson Ultraschall European Headquarters Germany	Niederlassung der EMERSON Technologies GmbH & Co. OHG Waldstraße 53-55 63128 Dietzenbach, Germany	Tel: 49 (0)6074/497-0 Tel: 49 (0)6074/497-784 Fax: 49 (0)6074/497-199 info@branson.de
Branson Ultrasuoni, S.r.l. Italy	Via Dei Lavoratori, 25 20092 Cinisello Balsamo Milano, Italy	Tel: 39-02-660-8171 Fax: 39-02-660-10480
Branson Ultrasonics B.V. Netherlands	P.O. Box 9, 3760 Soest The Netherlands	Tel: 31-35-60-98101
Branson Ultrasonidos S.A.E. Portugal	Rua General Orlando Barbosa 74, RC-NP 4490-640 Póvoa de Varzim Portugal	Tel: 351-936-059-080 Mobil: 351-252-101-754

Table 1.4 Authorized Service Centers (Europe)

Name	Address	Tel/Fax Number
Emerson a.s., division Branson Slovakia	Piestandska 1202/44 91528 Nove Mesto Nad Vahom Slovak Republic	Tel: 421-32-7700-501 Fax: 421-32-7700-470
Branson Ultrasonidos S.A.E. Spain	Edificio Emerson C/Can Pi, 15 1ª Planta (Antigua Carretera del Prat) Polígono Industrial Gran Vía Sur 08908 HOSPITALET DE LLOBREGAT (BARCELONA) Spain	Tel: 34-93-586-0500 Fax: 34-93-588-2258
Branson Ultrasonics S.A. Switzerland	Sonifers: Case Postale 1031 Bransonics: Chemin du Faubourg-de-Cruseilles 9 CH 1227, Carouge, Switzerland	Tel: 41-22-304-8340 Tel: 41-58-611-1222 Fax: 41-22-304-8359
Branson Ultrasonics United Kingdom	158 Edinburgh Avenue Slough, Berkshire England SL1 4UE	Tel: 44-1753-756675 Fax: 44-1753-551270
Branson Ultraschall Russia	Torfyanaya road, 7F 197374, Saint-Petersburg Russia	Tel: 7-812-449-35-24 Mobile: 7-962-693-77-12

Chapter 2: Introduction

2.1	Models Covered	12
2.2	Compatibility with other Branson Products	15
2.2	Compatibility with other Branson Products	15
2.4	Controls and Indicators	18
2.5	Welding Systems	21
2.6	Glossary	22

2.1 Models Covered

This manual covers all models of the DCX HD Power Supply.

Table 2.1 Models Covered in this manual

Frequency	Power	Model	EDP
20 kHz	4000 W	Horizontal	159-132-1869
		Vertical	159-132-1874
30 kHz	1500 W	Horizontal	159-132-2053
		Vertical	159-132-2054
	3000 W	Horizontal	159-132-2051
		Vertical	159-132-2052
40 kHz	800 W	Horizontal	159-132-2100
		Vertical	159-132-2101
	1600 W	Horizontal	159-132-2102
		Vertical	159-132-2103
	2400 W	Horizontal	159-132-2104
		Vertical	159-132-2105

2.1.1 Overview of these Models

Figure 2.1 The DCX HD Power Supply (Horizontal)



Figure 2.2 The DCX HD Power Supply (Vertical)



The DCX HD Power Supply generates ultrasonic energy through an ultrasonic converter for welding plastics. Several models are available, depending on the desired frequency (for example, 20 kHz), the desired power range (for example, 4.0 kW), and the intended mounting arrangement (horizontal or vertical). The power supply also contains a microprocessor-based controller module that provides for control and monitoring of welding operations.

The power supply provides the following features:

End of Weld Store: Allows the power supply to track and store the frequency of the last weld.

Timed Seek: Tracks and starts the stack on the correct frequency. It does this by running the horn at a low-level amplitude (10 %) to find and lock on to the stack operating frequency. Seeks are timed from the moment sonics was last activated.

Line Regulation: Maintains converter amplitude by regulating for variances in the line voltages.

Load Regulation: Maintains converter amplitude over the full range of rated power.

System Protection: Protects the power supply by providing six levels of protection.

- Voltage
- Current
- Phase
- Temperature
- Power
- Frequency

Web Page Interface: Provides access, via Ethernet connection, to power supply information, diagnostics, and configuration web pages.

Frequency Offset: Provides for applying an external frequency offset to the operating frequency.

Amplitude Control: Provides complete control of amplitude throughout the weld cycle: programmable starting ramp, and digital setting of weld amplitude.

2.2 Compatibility with other Branson Products

Table 2.2 Power Supply Compatibility with Branson Converters

DCX HD Models	Converter
20 kHz / 4000 W	CR-20
	CR-20S
	CR-20C
	CH-20S (932 AH SPL)
	CH-20C
	CS-20S
	CS-20C
30 kHz / 1500 W 30 kHz / 3000 W	CR-30S
	CR-30C
	CH-30S
	CH-30C
	CS-30S
	CS-30C
40 kHz / 800 W 40 kHz / 1600 W 40 kHz / 2400 W	CR-40S (4TH)
	CR-40C
	4TP
	4TR

NOTICE	
	<p>Special adaptor cables are available to connect to MS-style converters (CR20 and 4TR). See Table 7.8 DCX HD Power Supply System Cables.</p>

2.3 Features

2.3.1 The Welding System

The welding system consists of a DCX HD Power Supply and a converter-booster-horn stack. The system can perform ultrasonic welding, inserting, staking, spot welding, swaging, degating, and continuous ultrasonic operations. It is designed for automated, semi-automated and/or manual production operations.

2.3.2 The Power Supply

The DCX HD Power Supply consists of an ultrasonic power supply assembly with a system controller and user interfaces. The ultrasonic power supply assembly converts conventional 50/60 Hz line current to 20 kHz, 30 kHz or 40 kHz electrical energy. The system controller controls the welding system.

Listed below are the control features of the Branson DCX HD Power Supply ultrasonic welding system

- **Autotuning:** Branson Power Supply tuning ensures that the system is running at peak efficiency.
- **Digital Amplitude Setting:** This feature allows you to set the exact amplitude necessary for your application, allowing increased range and setting repeatability over analog systems.
- **Frequency Offset:** This process feature allows a user to set a frequency value, for certain specific applications, where the force imparted on the fixture or anvil causes a frequency shift in the stack's operation. You should only use this feature when advised to do so by Branson.
- **Horn Signature:** Using the DCX Web Page Interface, you may scan your ultrasonic stack to view its operating frequency on your computer, using digital readouts and bar graphs to give you the best picture of the stack's operation.
- **LCD (Liquid Crystal Display):** Provides a clear visual interface to monitor and configure the system.
- **Membrane Keys:** For high reliability and immunity from factory dust and oils.
- **Login ID Numbers:** Allows for keeping track of user access to the DCX HD Web Page Interface.
- **Ramp Starting:** The starting of the DCX HD Power Supply and horn is done at a rate that helps reduce electrical and mechanical stress on the system. The horn start rate may be adjusted for some tough-to-start applications.
- **Seek:** Ensures operation at resonance; minimizes tuning errors; and operates the stack at low amplitude (approximately 10 %), then provides a means of sensing and storing the resonant operating frequency value.
- **Start-up Diagnostics:** At start-up, the controls test the major internal components.
- **Timed Seek:** When enabled, will do a Seek once every minute to update horn resonant frequency to memory. This is especially useful when the welding process affects the actual temperature of the horn, causing a resonant frequency shift.
- **True Wattmeter:** The controls on the power supply include a true wattmeter for accurate measurement of power and energy.
- **Web Page Interface:** Provides access, via Ethernet connection, to power supply information, diagnostics, and configuration web pages.

2.3.3 The Actuator

The DCX HD Power Supply does not provide actuator control functions, and does not interface with actuator signals.

2.3.4 Converter/Booster/Horn Assembly

The Converter

The ultrasonic electrical energy from the power supply is applied to the converter (sometimes called the transducer). This transforms the high frequency electrical oscillations into mechanical vibrations at the same frequency as the electrical oscillations. The heart of the converter is piezoelectric ceramic elements. When subjected to an alternating voltage, these elements alternately expand and contract, resulting in better than 90 % conversion of electrical to mechanical energy.

The Booster

Success in ultrasonic assembly depends on the right amplitude of movement at the horn face. Amplitude is a function of horn shape, which is largely determined by the size and form of the parts to be assembled. The booster can be used as a mechanical transformer to increase or decrease the amplitude of vibrations applied to the parts through the horn.

The booster is a resonant half-wave section of aluminum or titanium. It is mounted between the converter and the horn, as part of the ultrasonic stack. It also provides a clamping point for rigid stack mounting.

Boosters are designed to resonate at the same frequency as the converter with which they are used. Boosters are usually mounted at a nodal (minimum vibration) point of axial motion. This minimizes the loss of energy and prevents vibration from being transmitted to the stack supporting structure.

The Horn

The horn is selected or designed for a specific application. Each horn is tuned typically as a half-wave section that applies the necessary force and vibration uniformly to the parts to be assembled. It transfers ultrasonic vibrations from the converter to the workpiece. The horn is mounted to the booster as part of the ultrasonic stack.

Depending on their profile, horns are referred to as stepped, conical, exponential, bar, or catenoidal. The shape of the horn determines the amplitude at the face of the horn. Depending on the application, horns can be made from titanium alloys, aluminum, or steel. Titanium alloys are the best materials for horn fabrication due to their high level of strength and low loss. Aluminum horns are usually chrome- or nickel-plated or hard-coated to reduce wear. Steel horns are for low amplitude requiring hardness, such as ultrasonic insertion applications.

2.4 Controls and Indicators

2.4.1 DCX HD Power Supply Front Panel

Figure 2.3 DCX HD Power Supply Front Panel Controls and Indicators



Table 2.3 DCX HD Power Supply Front Panel Controls and Indicators

Item	Name	Function
1	LCD	For detailed information refer to Figure 2.4 LCD Description and Table 2.4 LCD Description .
2	Up/Down Arrow Keys	Use to adjust the amplitude of ultrasonic vibrations (10 % to 100 %). Also used to select registers and edit register values.
3	Alarm Reset Key	Use the Reset key to reset alarms. When changing system registers, use the Reset key to set a register back to its default value.
4	Configuration Key	Use the Configuration key to change system registers. For information on using the Configuration key to set system registers see 6.4 Configuring the Power Supply Registers
5	Ultrasonic Test Key	Use the Test key to turn on Sonics.
6	Power-On indicator	Lights when the power supply is connected to main power and the power switch is on.
7	Ethernet Service Port	Use the Ethernet Service port to connect to the DCX HD Power Supply Web Page Interface. For detailed information on using the web page interface refer to the DCX HD Power Supply Web Page Interface Instruction Manual.

Figure 2.4 LCD Description

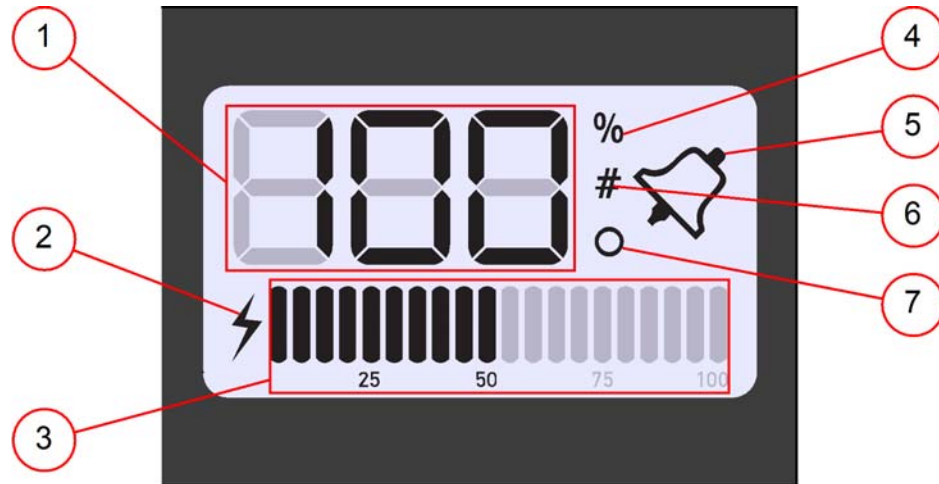

Table 2.4 LCD Description

Items	Name	Function
1	Numeric Display	Displays the power supply amplitude setting, a register number, or a register value.
2	Sonics Active Indicator	Indicates ultrasonics is running.
3	Power/Frequency Bar Graph	Shows the true percentage of ultrasonic power during a weld cycle. The bar graph can be configured to show the peak power or the frequency at the end of each weld or test cycle. For instructions on how to modify this setting see 6.4 Configuring the Power Supply Registers For a detailed bar graph description, and bar graph reading examples, see 6.5.2 Frequency Bar Graph Interpretation
4	Percentage Icon	Indicates the value shown is the amplitude setting.
5	Alarm Icon	A flashing Icon which indicates an alarm condition.
6	Number Sign Icon	Indicates that the value shown on the numeric display is a register number. Use up and down keys to select a register. For more information see 6.4 Configuring the Power Supply Registers
7	Circle Icon	Indicates that the value shown on the numeric display is a register value. Use up and down keys to modify the register value. For more information see 6.4 Configuring the Power Supply Registers

2.4.2 DCX HD Power Supply Connections

Figure 2.5 DCX HD Power Supply Back Panel (Horizontal)



Figure 2.6 DCX HD Power Supply Bottom Panel (Vertical)

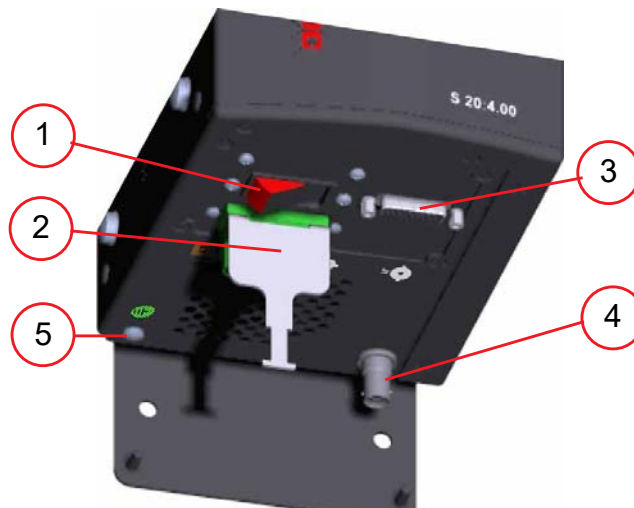

Table 2.5 Connections to the DCX HD Power Supply

Item	Name	Function
1	Circuit Breaker / Power Switch	Turns the AC main power on or off.
2	Line Input Connector	Detachable connector block for connecting the input power. For wiring details refer to Chapter 5: Installation and Setup .
3	User I/O Connector	Provides the necessary input/output signals to interface with user automation or control interfaces. For detailed information on interfacing with the DCX HD Power Supply refer to Chapter 5: Installation and Setup .
4	RF Connector	SHV connector for RF cable, which provides ultrasonic energy to the converter.
5	Ground Screw	Ground screw to serve as a redundant safety measure.

2.5 Welding Systems

2.5.1 Principle of Operation

Thermoplastic parts are welded ultrasonically by applying high frequency vibrations to the parts being assembled. The vibrations, through surface and intermolecular friction, produce a sharp rise in temperature at the welding interface.

When the temperature is high enough to melt the plastic, there is a flow of material between the parts. When the vibrations stop, the material solidifies under pressure and a weld results.

2.5.2 Weld System Applications

DCX HD Power Supply weld systems can be used for the following applications:

- Ultrasonic welding
- Cutting and sealing thermoplastic fabric and film
- Staking, spot welding, swaging, and degating thermoplastic parts
- Other ultrasonic processing applications

DCX HD Power Supply weld systems typically consist of a power supply operated with a fixed converter-booster-horn stack.

2.6 Glossary

The following terminology may be encountered when using or operating a DCX HD Power Supply ultrasonic welding system:

Actuator: The unit which houses the converter/booster/horn stack assembly in a rigid mounting, allowing the stack to move up and down, either mechanically or pneumatically, applying force to the part at a user-adjustable force and velocity.

Alarm: Visual indication of error.

Amplitude Control: The ability to set amplitude digitally or by an external control.

Amplitude: The peak-to-peak movement at the horn face. Always expressed as a percentage of the maximum.

Booster: A one-half-wavelength-long resonant metal section mounted between the converter and horn, sometimes having a change in cross-sectional area between the input and output surfaces. The booster mechanically alters the amplitude of vibrations received from the converter, and imparts the new amplitude to the horn.

Clamping Force: The pounds or kilograms exerted by the horn onto the workpiece.

Converter: The device that converts electrical energy into mechanical vibrations at a high frequency (an ultrasonic rate).

Counters: A record of the number of cycles, general alarms, power-on hours, etc, recorded in the power supply.

Degating: Removing a molded part from its runner system.

Energy Director: A triangular-shaped projection of plastic material which concentrates the ultrasonic energy at the joint interface of a plastic part.

External Amplitude Control: Enables you to access real-time amplitude control directly via the user I/O connector.

External Frequency Control: Enables you to access real-time frequency offset control directly via the user I/O connector.

Fixture: A device for holding a part in position for assembly.

Flash: Material displaced from the joint area.

Forming: Reshaping a section of thermoplastic.

Fretting corrosion: A black surface condition, that results from friction between metal parts, that appears on the converter-booster-horn stack mating surfaces.

Frequency: The operating frequency of the ultrasonic stack. The frequency stored is measured at the end of the ultrasonic portion of the cycle (when ultrasonics are terminated).

Frequency Offset: An offset factor applied to the ultrasonic frequency stored in the power supply.

Gain: The ratio of output to input amplitude of a horn or booster.

Horn: A bar or metal section, usually one half-wavelength-long which transfers vibratory energy to the workpiece.

Horn Amplitude: The peak-to-peak displacement of a horn at its work face.

Horn Scan: A scan to enhance selection of operating frequency and control parameters.

Insertion: The process of embedding a metal component in plastic.

Interface: 1. The contact surface of two mating parts. 2. The connection between two pieces of equipment.

Joint: The weld surfaces.

Parameter: A unique factor or element which affects the welding operation in a particular mode.

Parameter Range: Valid range of parameters accepted for a particular setup.

Power Supply: The electronic instrument in an ultrasonic assembly system which changes conventional 50/60 Hz electrical power into high frequency electrical power at 20 kHz, 30 kHz or 40 kHz.

Seek: The activation of ultrasonics at a low-level (10 %) amplitude, for the purpose of finding the resonant frequency of the stack.

Staking: The process of melting and reforming a plastic stud to mechanically lock a dissimilar material in place.

Swaging: The process of capturing another component of an assembly by melting and reforming a ridge of plastic.

Thermoplastic: A polymer which undergoes a reversible change of state when subjected to heat.

Thermoset: A polymer which undergoes an irreversible change when subjected to heat.

Ultrasonic Power: Presence of ultrasonic power at the horn face.

Ultrasonic Welding: The use of ultrasonic vibrations to generate heat and subsequently melt the mating surfaces of two thermoplastic parts. When ultrasonic vibrations stop, the molten material resolidifies, and a weld occurs.

User ID: A unique number used to keep track of user access to the web page interface.

Weld system: A combination of components required to perform an ultrasonic operation. Usually consists of a power supply, converter, booster, and horn, with either an actuator or a handheld device, or in a fixed, mounted location.

Chapter 3: Delivery and Handling

3.1	Shipping and Handling	26
3.2	Receiving	27
3.3	Unpacking the Power Supply	28
3.4	Take Inventory of Small Parts	29
3.5	Returning Equipment	30

3.1 Shipping and Handling

CAUTION	Heavy Object
	<p>The power supply may be heavy. Handling, unpacking, and installation may require the assistance of a colleague or the use of lifting platforms or hoists.</p>

3.1.1 Environmental Specifications

The DCX HD Power Supply is an electronic unit that converts line voltage to ultrasonic energy and responds to user input for regulating the weld process. Its internal components are sensitive to static discharge, and many of its components can be harmed if the unit is dropped, shipped under improper conditions, or otherwise mishandled.

The following environmental guidelines should be respected in the shipping of the power supply.

Table 3.1 Shipping Specifications

Environmental Condition	Acceptable Range
Storage / Shipping Temperature	-25° C / -13° F to +55° C / +131° F (+70° C / +158° F for 24 hours)
Shock / Vibration (transit)	45 g shock / 0.5 g and (3 to 100 Hz) vibration per ASTM 3332-88 and 3580-90
Drop Test	ISTA Procedure 1 & 2A (while packaged)
Humidity	Maximum 95%, non-condensing

3.2 Receiving

The DCX HD Power Supply is a sensitive electronic device. Many of its components can be harmed if the unit is dropped or otherwise mishandled.

Scope of Delivery

Branson equipment is carefully checked and packed before dispatch. It is recommended, however, that you follow the procedure below upon receiving your DCX HD Power Supply.

Inspect the Power Supply when it is delivered, take the following steps:

Table 3.2 Inspect the power supply

Step	Action
1	Verify that all parts are complete according to the packing slip.
2	Check the packing and the unit for damage (visual inspection).
3	Report any damage claims to your carrier immediately.
4	Determine if any component has become loose during shipping and, if necessary, tighten screws.

NOTICE	
	<p>If the goods delivered have been damaged during shipping, please contact the forwarding agent immediately. Retain packing material (for possible inspection or for sending back the unit).</p>

3.3 Unpacking the Power Supply

NOTICE	
	<p>If there are any visible signs of damage to the shipping containers or the product, or you later discover hidden damage, NOTIFY YOUR CARRIER IMMEDIATELY. Save the packing material.</p>

The power supply is fully assembled. It is shipped in a sturdy cardboard box. Some additional items are shipped in the box with the power supply. Note orientation of packaging material in case return/repack is necessary. When unpacking the power supply, take the following steps:

Table 3.3 Unpacking the power supply

Step	Action
1	Unpack the power supply as soon as it arrives. Save the packing material
2	Verify you have all of the equipment ordered. Some components are packed inside other boxes.
3	Inspect the controls, indicators, and surface for signs of damage.
4	Remove the cover of the power supply to check if any components became loose during shipping.

3.4 Take Inventory of Small Parts

Table 3.4 Small Parts included (=x): Power Supply Assemblies

Part or Kit	20 kHz	30 kHz	40 kHz
Mylar® plastic film Washer Kit	X	X	
Silicone Grease			X
Spanners (2)	X	X	X

* Mylar is a registered trademark of DuPont Teijin Films.

3.4.1 Cables

The RF cable connects the power supply to the converter. For automated systems you will also need a user I/O cable to monitor and control the power supply. Check your invoice for cable types and cable lengths.

Table 3.5 DCX HD Power Supply System Cables

P/N	Description
100-240-383	Cable, RF 8 ft (2.5 m)
100-240-384	Cable, RF 15 ft (4.5 m)
100-240-385	Cable, RF 25 ft (7.5 m)
100-240-386	Cable, RF 50 ft (15 m)
100-240-387	Cable, RF right angle 8 ft (2.5 m)
100-240-388	Cable, RF right angle 15 ft (4.5 m)
100-240-389	Cable, RF right angle 25 ft (7.5 m)
100-240-390	Cable, RF right angle 50 ft (15 m)
100-240-391	Cable, RF adaptor for CR20 converter 3 ft (0.9 m)
100-240-392	Cable, User I/O 25 ft (7.5 m)
100-240-393	Cable, User I/O 50 ft (15 m)
200-240-396	Cable Ethernet Cat 5e 7 ft (2.1 m)
100-240-397	Cable, RF adaptor for 4TR converter 3 ft (0.9 m)

3.5 Returning Equipment

If you are returning equipment to Branson Ultrasonic Corporation, please call your Customer Service Representative to receive approval to return the goods. Refer to [1.3 How to Contact Branson](#).

Chapter 4: Technical Specifications

4.1	Technical Specifications	32
4.2	Physical Description	34

4.1 Technical Specifications

NOTICE	
	All specifications are subject to change without notice.

4.1.1 Environmental Specifications

The DCX HD Power Supply has the following environmental specifications:

Table 4.1 Environmental Specifications

Environmental Condition	Acceptable Range
Ambient Operating Temperature	+41° F to +104 F (+5° C to +40° C)
Storage / Shipping Temperature	-13° F to +131°F (-25° C to +55° C)
Humidity	Maximum 95%, non-condensing
Operating Altitude	Up to 6560 ft (2000 m)
IP Rating	2X

4.1.2 Electrical Specifications

The following tables list input voltage and current requirements for the DCX HD Power Supply.

Electrical Input Operating Voltages

Table 4.2 Electrical Input Operating Voltages

Power Supply Rating	Input Operating Voltage
All Models	200 V to 230 V Nominal (180 V Min.* to 253 V Max.), 50 Hz or 60 Hz, Single Phase

* 200 V Min. for 4 kW units.

Input Current and Circuit Breaker Specifications

Table 4.3 Input Current and Circuit Breaker Specifications

Model	Power	Current Rating
20 kHz	4000 W	25 A Max. @ 200 V / 25 A Breaker
30 kHz	1500 W	10 A Max. @ 200 V / 15 A Breaker
40 kHz	800 W	5 A Max. @ 200 V / 10 A Breaker

Continuous Duty Maximum Power

Table 4.4 Continuous Duty Max. Power

Model	Power	Continuous Duty. Max. Power
20 kHz	4000 W	2000 W
30 kHz	1500 W	800 W
40 kHz	800 W	400 W

NOTICE



High duty cycles require additional cooling for the converter. For information on converter cooling refer to [5.6 Converter Cooling](#) in [Chapter 5: Installation and Setup](#).

NOTICE



System average power must be limited to the specified continuous maximum. Higher peak power, up to the maximum acceptable power limit, with an on time of up to 10 seconds may be obtained if appropriate off time ensures that, on average, the Continuous Duty Maximum Power is not exceeded.

4.2 Physical Description

This section describes the physical dimensions of the DCX HD Power Supply.

NOTICE	
	Dimensions are nominal.

Table 4.5 Dimensions and Weights of DCX HD Power Supply

Size	Height (Benchtop)	Width (Benchtop)	Height (Vertical)	Width (Vertical)	Depth	Weight
Small					7.4 in 187 mm	16 lb 7.25 kg
Medium	5.5 in 132 mm	14 in 355 mm	14 in 355 mm	5.2 in 132 mm	8.6 in 220 mm	18 lb 8.15 kg
Large					10.6 in 270 mm	22 lb 10 kg

For detailed dimensional information refer to [Chapter 5: Installation and Setup](#).

Chapter 5: Installation and Setup

5.1	About Installation.	36
5.2	Installation Requirements	37
5.3	Installation Steps	43
5.4	Power Supply Configuration.	54
5.5	Assembling the Acoustic Stack.	55
5.6	Converter Cooling.	59
5.7	Testing the Installation	60
5.8	Still Need Help?	61

5.1 About Installation

This chapter is intended to help the installer with the basic installation and setup of your new DCX HD Power Supply.

CAUTION	Heavy Object
	The power supply, and related components are heavy. Handling, unpacking, and installation may require the assistance of a colleague or the use of lifting platforms or hoists.

International safety-related labels are found on the power supply. Those that are of importance during installation of the system are identified in [Figure 1.1](#) and [Figure 1.2](#).

5.2 Installation Requirements

This section covers the location requirements, mounting options, power supply dimensions, environmental requirements, and electrical requirements, to help you plan and execute your installation successfully.

5.2.1 Location

The DCX HD Power Supply comes in two different models Horizontal (benchtop) and Vertical (which may be back mounted or side mounted).

The power supply should be accessible for parameter changes and settings, and it can be placed in a horizontal or vertical orientation (depending on your selected model). The power supply should be located in an area away from radiators or heating vents and positioned so it does not draw in dust, dirt or material via its cooling fan.

Refer to the illustrations on the pages that follow for dimensional drawings of both models. All dimensions are approximate and may vary slightly:

[Figure 5.1 DCX HD Power Supply Benchtop Dimensional Drawing.](#)

[Figure 5.2 DCX HD Power Supply Vertical Mount Dimensional Drawing \(800 W\).](#)

[Figure 5.3 DCX HD Power Supply Vertical Mount Dimensional Drawing \(1.5 kW\).](#)

[Figure 5.4 DCX HD Power Supply Vertical Mount Dimensional Drawing \(4 kW\).](#)

Figure 5.1 DCX HD Power Supply Benchtop Dimensional Drawing

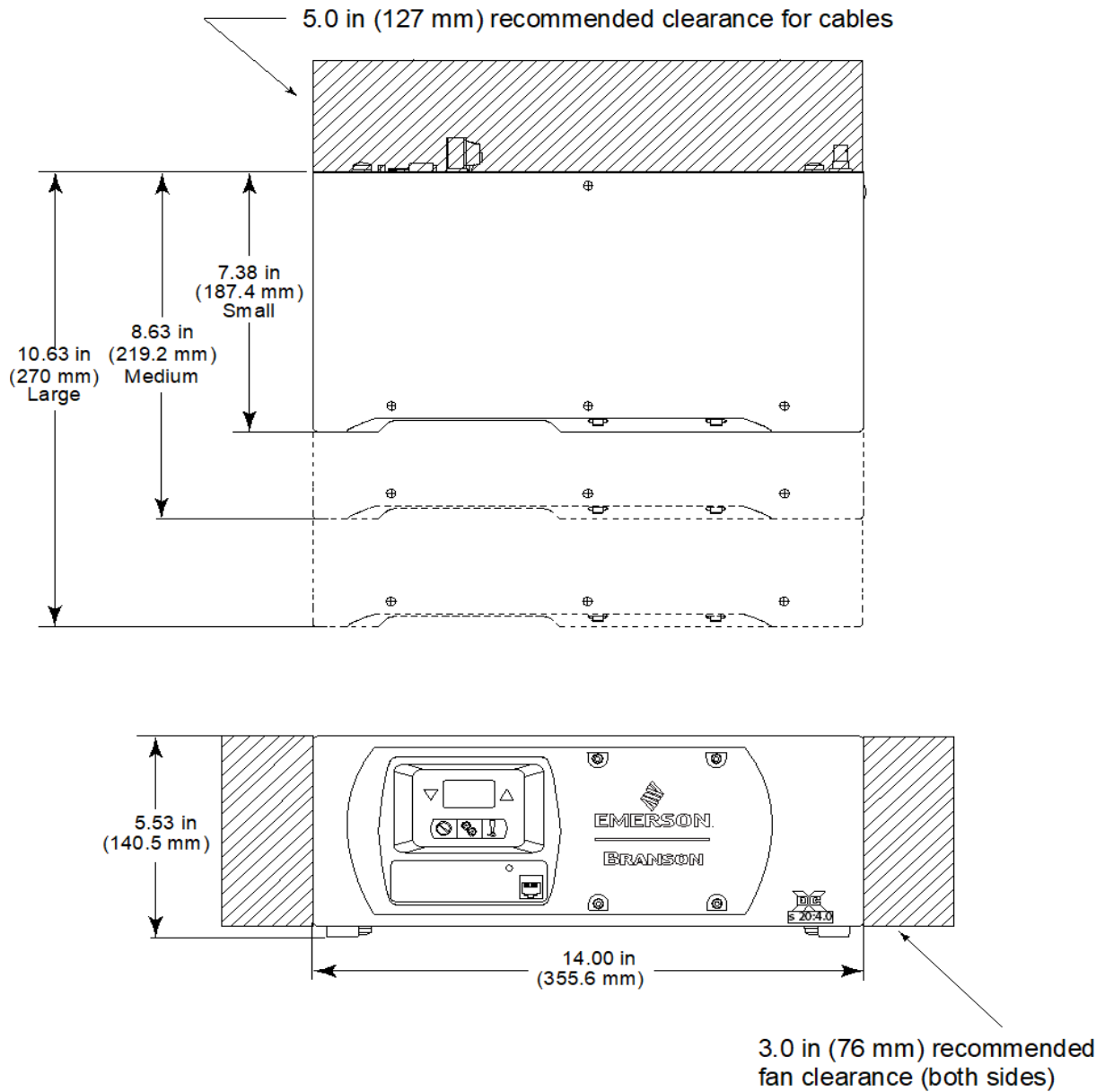

Figure 5.2 DCX HD Power Supply Vertical Mount Dimensional Drawing (800 W)

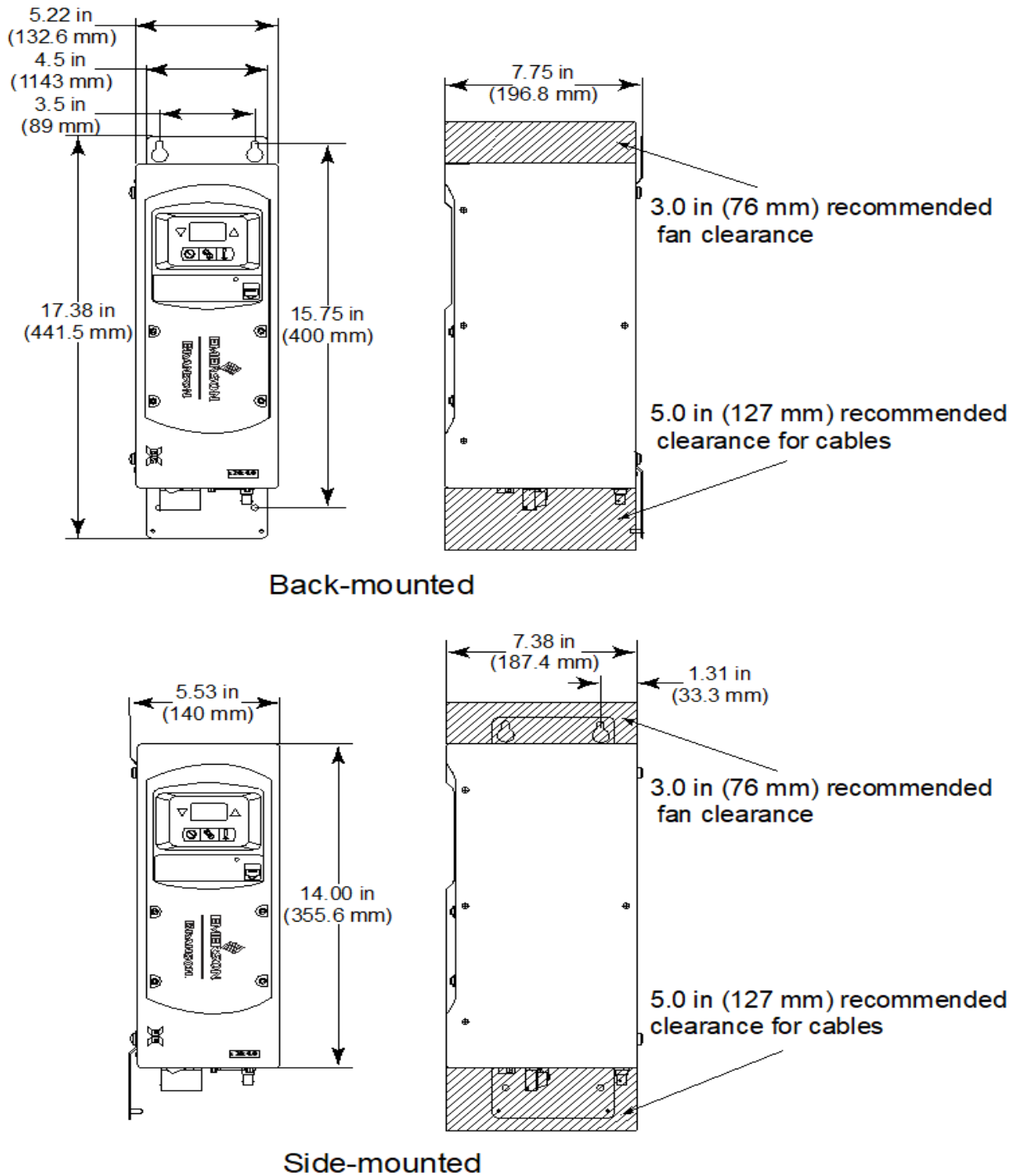
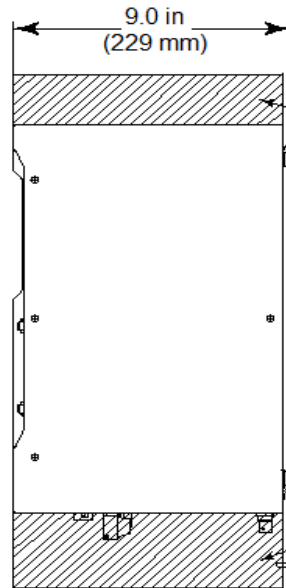
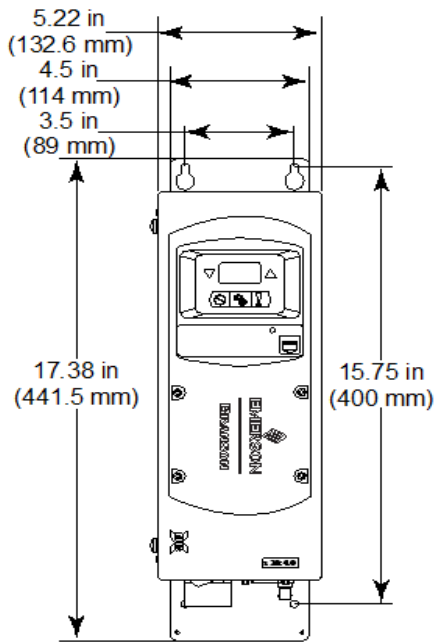

Figure 5.3 DCX HD Power Supply Vertical Mount Dimensional Drawing (1.5 kW)



3.0 in (76 mm) recommended fan clearance

5.0 in (127 mm) recommended clearance for cables

Back-mounted

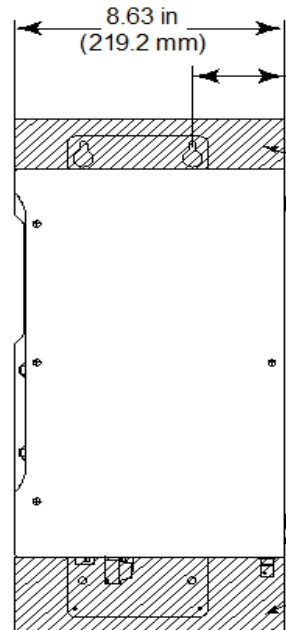
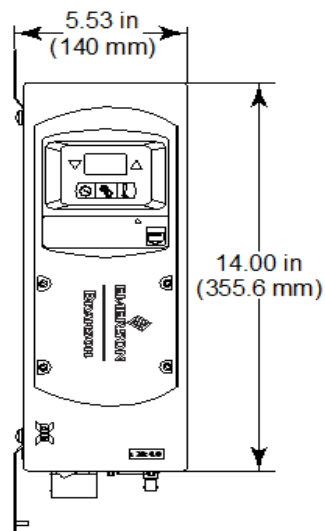

3.0 in (76 mm) recommended fan clearance

5.0 in (127 mm) recommended clearance for cables

Side-mounted

Figure 5.4 DCX HD Power Supply Vertical Mount Dimensional Drawing (4 kW)

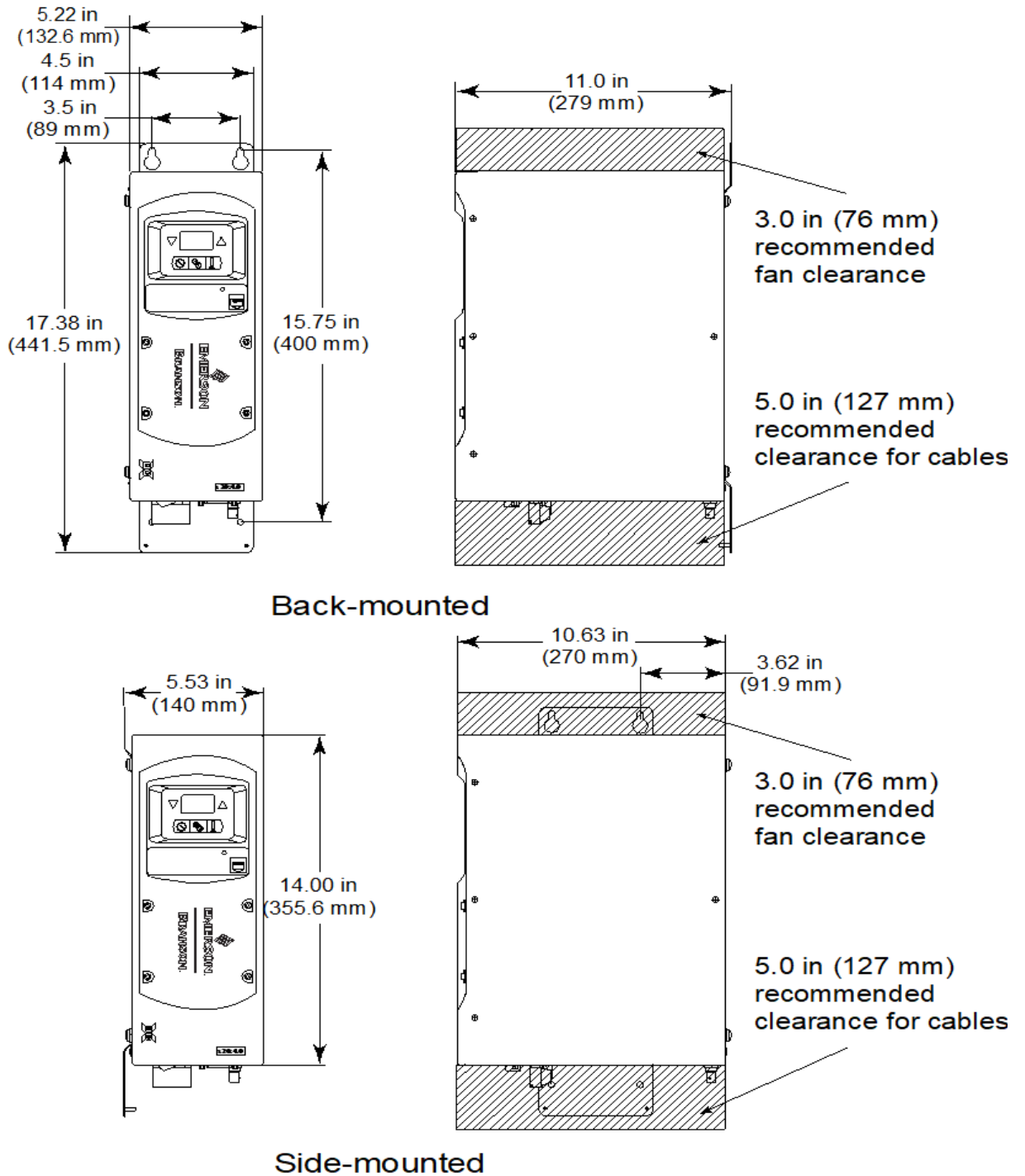

5.2.2 Environmental Requirements

Verify the DCX HD Power Supply is operated in an environment that meets the temperature and humidity requirements indicated in [Table 5.1 Environmental Requirements](#).

Table 5.1 Environmental Requirements

Environmental Condition	Acceptable Range
Ambient Operating Temperature	+41° F to +104 F (+5° C to +40° C)
Humidity	Maximum 95%, non-condensing
Operating Altitude	Up to 6560 ft (2000 m)
IP Rating	2X

5.2.3 Electrical Input Power Ratings

Connect the power supply to a single-phase, grounded, 3-wire, 50 Hz or 60 Hz 200 V to 230 V power source. [Table 5.2 Input Current and Circuit Breaker Specifications](#) lists the current and breaker ratings for the various models.

Table 5.2 Input Current and Circuit Breaker Specifications

Model	Power	Current Rating
20 kHz	4000 W	25 A Max. @ 200 V / 25 A Breaker
30 kHz	1500 W	10 A Max. @ 200 V / 15 A Breaker
40 kHz	800 W	5 A Max. @ 200 V / 10 A Breaker

5.2.4 Pneumatic Requirements

Your welding system may require a cooling air stream for the converters. In continuous operations, or applications with longer duty cycles, it may be necessary to cool the horn as well as the converter.

Typically 80 cubic feet (2.26 m³) per hour of clean, dry, compressed air are required to cool most welding operations.

To verify the 80 cubic feet (2.26 m³) per hour cooling air stream required for your welding system, refer to [5.6 Converter Cooling](#)

5.3 Installation Steps

WARNING	High Voltage Hazard
	<p>To prevent the possibility of an electrical shock:</p> <ul style="list-style-type: none"> • Ensure the power source is disconnected before beginning work on line connections • Ensure the power switch on the back of the unit is in the OFF position before making any electrical connections • Always plug the power supply into a grounded power source • To prevent the possibility of an electrical shock, ground the power supply by securing an AWG #14 grounded conductor to the ground screw located next to the air outlet • Ensure power supply installation is performed by qualified personnel and in accordance with local standards and regulations

Basic installation notes:

- To avoid problems associated with EMI, you should route high power lines (AC and Ultrasonic RF) away from low power lines (controls signals)
- You should consider future troubleshooting and repair when installing all wiring. All wiring should be either color coded or tagged with industrial wire tags
- The minimum cable bend radius is 5 times the cable outer diameter for RF cables
- The minimum cable bend radius is 10 times the cable outer diameter for user I/O & Ethernet cables
- Ground wires should not be shared with other equipment
- All inductive coils must be suppressed with appropriate devices, such as diodes or RC networks

5.3.1 Mount the Power Supply

The cable lengths are limited based on the operating frequency of the welding system. Performance and results can suffer if the RF cable is crushed, pinched, damaged or modified. Contact your Branson Representative if you have special cable requirements.

Do not place the power supply on the floor or in other locations that will allow dust, dirt or contaminants to be drawn into the power supply.

NOTICE	
	<p>Special fan filter kits are available for use in dusty environments. See Table 7.12.</p>

NOTICE	
	<p>Do not block exhaust and intake air circulation, which is needed to maintain a safe operating temperature.</p>

5.3.2 Horizontal (Benchtop) Mounting

The Horizontal DCX HD Power Supply is designed to be placed on a workbench (rubber feet on bottom) within cable-length limits of the stack. It has one fan which draws cooling air from the left side to the right side, which must be free from obstruction. The controls on the front of the power supply should be accessible and readable for setup changes.

All electrical connections are made to the rear of the power supply, which should be positioned in your workspace with adequate clearance, approximately 3 in (76.2 mm) or more on either side, and 5 in (127 mm) to the rear) for cable access and ventilation. Do not place anything on top of the power supply case.

For a dimensional drawing of the Horizontal DCX HD Power Supply, see [Figure 5.1](#).

5.3.3 Vertical Mounting

The Vertical DCX HD Power Supply is designed to be mounted vertically (from the side or back) within cable-length limits of the stack. It has one fan which draws cooling air from the top to the bottom of the power supply, which must be free from obstruction. The controls on the front of the power supply should be accessible and readable for setup changes.

All electrical connections are made to the bottom of the power supply, which should be positioned with adequate clearance (approximately 3 in (76.2 mm) or more on the top, and 5 in (127 mm) to the bottom) for cable access and ventilation. Do not place anything on top of the power supply case.

For dimensional drawings of the Vertical DCX HD Power Supply, see figures [Figure 5.2](#), [Figure 5.3](#), and [Figure 5.4](#).

5.3.4 Mounting Considerations

In addition to the considerations mentioned above, the LCD's viewing angle should be taken into account when selecting a location for your DCX HD Power Supply. The LCD is designed to be viewed from the top. Please refer to [Figure 5.5](#) below when selecting a location for your DCX HD Power Supply.

Figure 5.5 LCD Viewing Angle

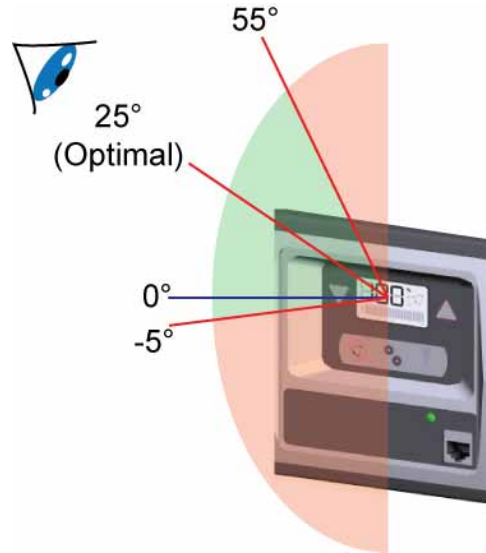

NOTICE	
	<p>Optimal viewing angle is 25° above the normal to the display (indicated by 0°).</p>

5.3.5 Electrical Connections

Figure 5.6 DCX HD Power Supply Connections (Horizontal Model)

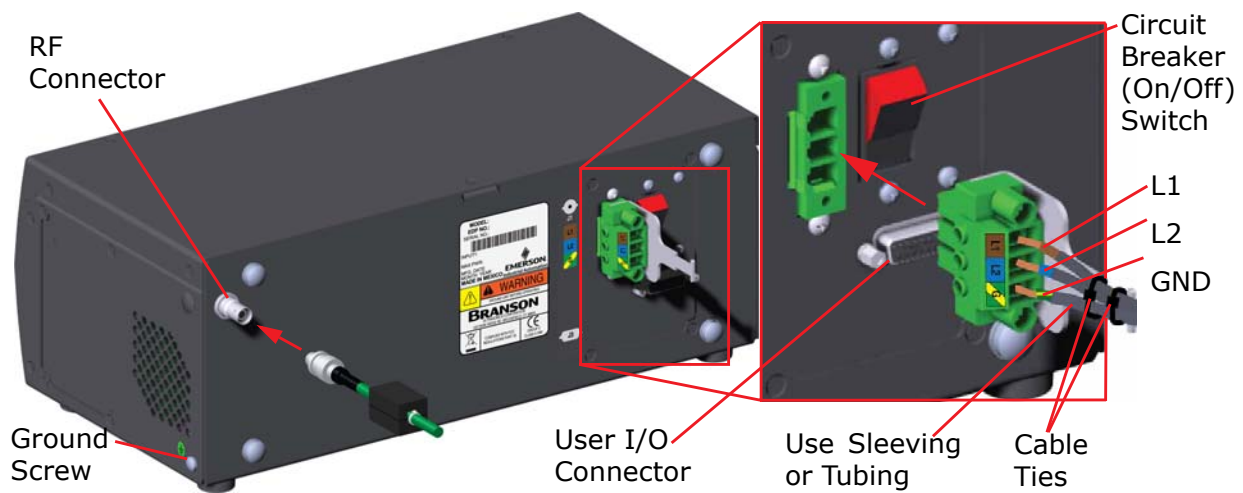
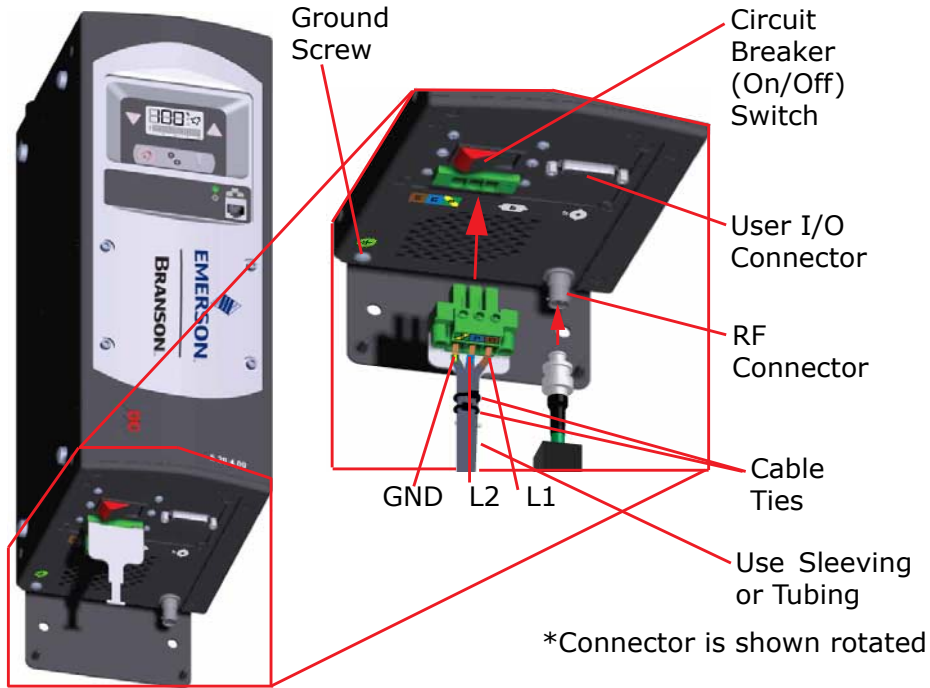



Figure 5.7 DCX HD Power Supply Connections (Vertical Model)



5.3.6 User I/O Connections

The user I/O is a standard interface for automation, provided on the power supply. It provides the ability to make your own interface for your automation, special control, or reporting needs. The interface cable has a 26-pin HD male D-Sub connector on one end, and wires on the other end. Pins are wired to ICEA standard color code (see [Figure 5.8](#) and [Table 5.3](#)).

NOTICE	
	<p>Ensure all unused wires are properly isolated. Failure to do so may result in a power supply malfunction.</p>

Digital I/O functions can be configured to either active-high or active-low using the DCX HD Power Supply Web Page Interface. [Table 5.5](#) to [Table 5.8](#) list the input and output functions available on the DCX HD Power Supply. See [Table 5.4](#) for the default user I/O pin assignments.

[Figure 5.9](#) and [Figure 5.10](#) show typical wiring examples.

For complete instructions detailing the web page interface consult the DCX HD Power Supply Web Page Interface Instruction Manual.

Figure 5.8 User I/O Cable Identification and Wire Color Diagram

User I/O Cable
 Stripped Jacket one end,
 HD-26 male connector other end
 (cable length as ordered)

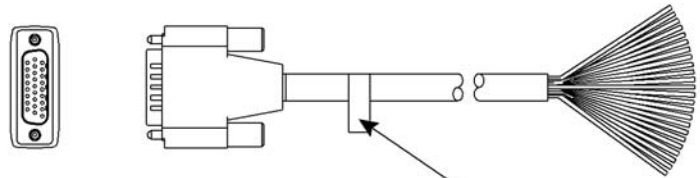

Wire Color Diagram
 Two Colors = Insulator/Stripe
 Three Colors = Insulator/Stripe/Dot

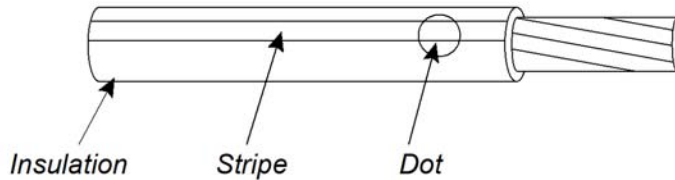

* Pins 11, 12, 13, 16 and 19-23 are not used.

5.3.7 User I/O Cable Pin Assignments

Table 5.3 User I/O Cable Pin assignments

Pin	Input/Output	Available Function	Signal Type	Signal Range	Color
1	Digital in 1	See Table 5.5	Digital Input	0 V to 24 V \pm 10%, 12 mA	Blk
2	Digital in 2				Wht
3	Digital in 3				Red
4	Digital in 4				Grn
5	+24 V Source	N/A	24 V Source	24 V \pm 10%, 250 mA Max CAUTION Do not provide 24 VDC through pins 5 and 6	Orn
6					Blu
7	Digital out 1	See Table 5.6	Digital Output	0 V to 24 V \pm 10%, 25 mA Max	Wht/Blk
8	Digital out 2				Red/Blk
9	Digital out 3				Grn/Blk
10	Digital out 4				Orn/Blk
14	Ground	N/A	24 V Ground	0 V	Grn/Wht
15					Blu/Wht
17	Analog in 1	See Table 5.7	Analog Input	0 V to +10 V, 2 mA	Wht/Red
18	Analog in 2				Orn/Red

Table 5.3 User I/O Cable Pin assignments

Pin	Input/Output	Available Function	Signal Type	Signal Range	Color
24	Analog out 1	See Table 5.8	Analog Output	0 V to +10 V, 1 mA Max	Red/Blk/ Wht
25	Analog out 2				Grn/Blk/ Wht
26	Analog GND	N/A	Analog Ground	0 V	Orn/Blk/ Wht

5.3.8 Default User I/O Connector Pin Assignments

Table 5.4 Default User I/O Connector Pin Assignments

Pin	Function	I/O Type	Values
1	External Start	Digital Input	Apply +24 VDC to run cycle.
2	Stack Adjustment		Apply +24 VDC to perform a stack adjustment.
3	External Reset		Apply +24 VDC to reset alarms.
4	Memory Clear		Apply +24 VDC to clear memory.
5	+24 VDC Source	I/O Signal Source	+24 V, 250 mA max.
6			CAUTION Do not provide 24 VDC through pins 5 and 6
7	Ready	Digital Output	+24 V indicates the system is ready.
8	Sonics Active		+24 V indicates ultrasonics are active.
9	General Alarm		+24 V indicates an alarm occurred.
10	Seek/Scan Out		+24 V indicates either Seek or a Scan is in progress.
14 15	+24 VDC Return and I/O Return	I/O Signal Return	Return for all pins except pins 17, 18, 24, and 25.
17	Amplitude In	Analog Input	1 V to + 10 V (10% to 100%).
18	Frequency Offset		1 V to + 9 V (5 V is zero offset).
24	Power Out	Analog Output	0 V to + 10 V (0% to 100%).
25	Amplitude Out		0 V to + 10 V (0% to 100%).
26	Analog Signal Return	Analog Signal Return	Return for pins 17, 18, 24, and 25.

5.3.9 Available Digital Input Functions

Table 5.5 Available Digital Input Functions

Function	Description
Cable Detect	Disables ultrasonics if 24 V signal is removed when using 0 V negative logic (active low) for the external Start input. Used to prevent ultrasonics from coming on if a cable is removed.
Display Lock	Locks the front panel display controls
External Horn Scan	Starts horn scan sequence.
External Reset	Resets alarm conditions.
External Seek	Activates ultrasonic energy at 10 % amplitude for the purpose of finding the ultrasonic stack resonant frequency.
External Start	Activates ultrasonic energy at the currently set amplitude. WARNING When using 0 V to activate ultrasonics (External Start signal), it is recommended to assign one input as Cable Detect to prevent sonics from activating if 24 V is lost by accident.
External Test	Performs a test cycle.
Memory Clear	Centers the power supply start frequency.
Stack Adjustment	Automatically adjust the power supply to optimally set the desired amplitude taking into account the present line voltage.

5.3.10 Available Digital Output Functions

Table 5.6 Available Digital Output Functions

Function	Description
General Alarm	Indicates an alarm occurred.
Overload Alarm	Indicates an overload alarm has occurred.
Ready	Indicates the system is ready.
Seek/Scan Out	Indicates either a seek or a horn scan is in progress.
Sonics Active	Indicates sonics are active.

5.3.11 Available Analog Input Functions

Table 5.7 Available Analog Input Functions

Function	Description		Valid Range
Amplitude In	Controls the amplitude of ultrasonic energy that will be delivered by the power supply.		1 V to 10 V* (10% to 100%)
Frequency Offset	Controls the frequency offset to the power supply operating frequency. Actual offset depends on the power supply operating frequency:		1 V to 9 V* (5 V is zero offset)
	Frequency	Offset Range	
	20 kHz	±400 Hz	
	30 kHz	±600 Hz	
	40 kHz	±800 Hz	

* If the input signals are not within their valid range, or if left unconnected, the power supply will use 50% amplitude and zero frequency offset, respectively.

5.3.12 Available Analog Output Functions

Table 5.8 Available Analog Output Functions

Function	Description			Valid Range
Amplitude Out	Provides a 0 V to 10 V output signal proportional to amplitude (0% to 100%).			0 V to 10 V (0 % to 100 %)
Power Out	Provides a 0 V to 10 V output signal proportional to ultrasonic power output (0% to 100%).			0 V to 10 V (0% to 100%)
Frequency Out	Provides a 0 V to 10 V output signal that indicates relative frequency in memory. Actual frequency depends on the power supply operating frequency:			0 V to 10 V (5 V is zero offset)
	Frequency	Lower Limit (0 V)	Upper Limit (10 V)	
	20 kHz	19,450 Hz	20,450 Hz	
	30 kHz	29,250 Hz	30,750 Hz	
	40 kHz	38,900 Hz	40,900 Hz	

* Pins 11, 12, 13, 16, and 19-23 are not used.

** If the input signals are not within their valid range, or if left unconnected, the power supply will use 50% amplitude and zero frequency offset, respectively.

5.3.13 Typical Digital I/O Wiring Examples

Figure 5.9 Typical Digital I/O Wiring Examples

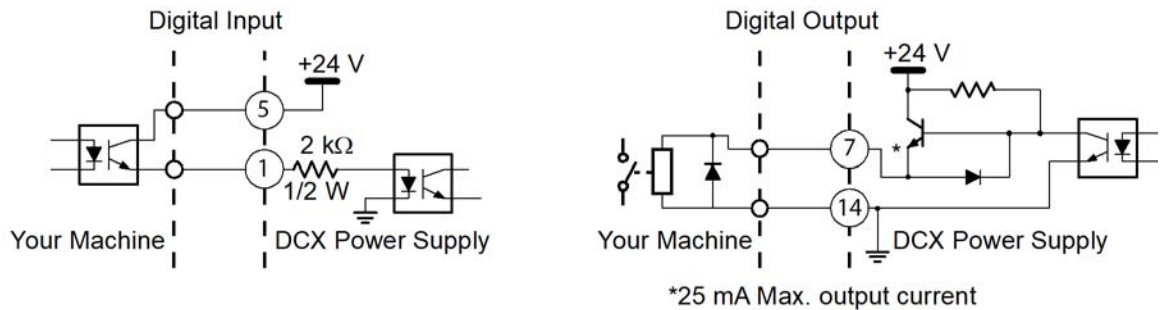

5.3.14 Typical Analog I/O Wiring Examples

Figure 5.10 Typical Analog I/O Wiring Examples

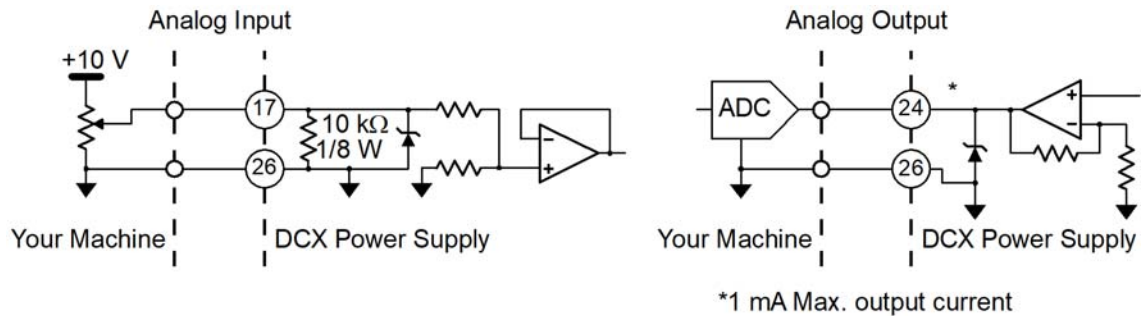

5.3.15 Output Power (RF Cable) Connection

Ultrasonic energy is delivered to the SHV connector on the power supply, which is then transmitted to the converter via the RF cable. The RF connector position depends on the power supply configuration. For Horizontal models it is located on the rear panel of the power supply. For Vertical models it is located on the bottom panel of the power supply.

To reduce electromagnetic interference (EMI), RF cables are equipped with a ferrite core (plastic case) on one end. This end is meant to be connected to the power supply.

WARNING	High Voltage Hazard
	<p>Operating the System with the RF Cable disconnected or damaged can present an electrical shock hazard.</p>



WARNING	High Voltage Hazard
	<p>To avoid the possibility of electrical shock. Converters need to be properly grounded.</p>
NOTICE	
	<p>To avoid the possibility of EMI interference, ensure the RF connection to the power supply is made with the cable end that has the ferrite core box attached (see Figure 5.11).</p>

Figure 5.11 RF Cable Connection





Table 5.9 RF Cable Connection

Item	Description
1	To Power Supply
2	Ferrite Core Box

5.3.16 Input Power Connection

WARNING	High Voltage Hazard
	<p>Ensure all electrical power is off when wiring input power to your DCX HD Power Supply connector block.</p> <p>To prevent the possibility of an electrical shock, ground the power supply by securing an AWG #14 grounded conductor to the ground screw located next to the air outlet.</p>

WARNING	High Voltage Hazard
	<p>If miss-wired, the power supply can present an electrical shock hazard.</p>

NOTICE	
	<p>The power supply can be permanently damaged if it is connected to the incorrect line voltage, or if the connection is mis-wired.</p>

Use the following procedure to connect the power supply to a single-phase, grounded, 3-wire, 50 Hz or 60 Hz 200 V to 230 V power source.

Table 5.10 Input Power Connection

Step	Action
1	Detach the connector block on the back of the power supply.
2	Use three properly sized wires (AWG #12, 2.5 mm or according to local standards) to connect the line 1, line 2, and ground to the connector block as shown on Figure 5.6 . Choose wires according to the current rating as specified in Table 5.2 and on the label located on the back of the unit. Be sure to use agency approved wiring and use sleeving or tubing on each wire for double insulation.
3	Use cable ties to secure the wires to the connector block metal piece. This will help to prevent the line and ground wires from becoming loose and will also act as a strain relief.
4	Secure an AWG #14 grounded conductor to the ground screw located next to the2 air outlet.
5	Connect the converter-booster-horn stack to the power supply using the RF cable. See 5.3.15 Output Power (RF Cable) Connection
6	Ensure the power switch on the back of the unit is in the OFF position. Plug the connector block back into the power supply. Tighten the two securing screws.
7	Connect the power supply to a single-phase, grounded, 3-wire, 50 Hz or 60 Hz 200 V to 230 V power source.

5.4 Power Supply Configuration

5.4.1 Selecting the Alarm Mode

The DCX Power Supply activates ultrasonic power after receiving an External Start signal. Ultrasonic power remains on until you turn off the power supply or the External Start signal. The DCX Power Supply response to alarm conditions can be configured to operate in one of two modes:

- **Latching:** In this mode the DCX Power Supply requires alarm conditions to be reset before a new weld cycle can begin. To reset alarm conditions while in this mode, either press the front panel Reset key or send an External Reset signal using the user I/O connector.
- **Non-Latching:** In this mode the DCX Power Supply does not require alarm conditions to be reset, and new weld cycle can begin upon receiving an External Start signal.

The alarm mode is factory-set to non-latching. For instruction on how to change the alarm mode refer to [6.4 Configuring the Power Supply Registers](#) in [Chapter 6: Operation](#) and to your DCX Series Web Page Interface Instruction Manual.

5.4.2 Configuring the Power Supply

Certain power supply configurations can be modified from the factory setting if needed. Although not usually requiring modifications from the factory setting, the following features are selectable:

- **Amplitude control:** Allows for varying the amplitude (10 % to 100 %) using the front panel LCD, the web page interface, or by way of external controls (analog signal applied through the user I/O analog input).
- **Latching Alarms:** Provides an option for selecting the power supply alarms to be latching (reset required) or non-latching (reset by reapplying the start signal).
- **Start Ramp Time:** Provides a selection for different start ramp times. This controls how fast the amplitude of the horn rises from zero to the currently set amplitude. Long ramp times may be useful when using large horns or high gain stacks.
- **End of Weld Frequency Store:** Provides an option for selecting if the stack frequency is stored at the end of each weld cycle.
- **Seek Ramp Time:** Provides a selection for different power supply seek ramp times.
- **Timed Seek:** Provides an option for monitoring, and storing the operating frequency at timed intervals (60 seconds). Periodic frequency seeks may be helpful when welder is not used for long periods of time. Seeks are timed from the moment sonics was last activated.
- **Seek Time:** Provides an option for selecting seek duration.
- **Frequency Offset:** Allows for varying the start frequency by way of external controls (analog signal applied through the user I/O analog input) or setting a fixed value using the web page interface. This is useful for certain applications, where the force imparted on the fixture or anvil causes a frequency shift in the stack's operation.

For instruction on how to change the power supply settings refer to [6.4 Configuring the Power Supply Registers](#) in [Chapter 6: Operation](#) and to your DCX HD Power Supply Web Page Interface Instruction Manual.

NOTICE	
	Consult with Branson before changing any default factory setting.

5.5 Assembling the Acoustic Stack

CAUTION	General Warning
	<p>The following procedure must be performed by a setup person. If necessary, secure the largest portion of a square or rectangular horn in a soft jawed vise. NEVER attempt to assemble or remove a horn by holding the converter housing or the booster clamp ring in a vise.</p>

CAUTION	General Warning
	<p>Do not use silicone grease with Mylar plastic film washers. Use only 1 (one) Mylar plastic film washer of the correct inside and outside diameters at each interface.</p>

NOTICE	
	<p>The use of a Branson torque wrench or the equivalent is recommended. P/N 101-063-787 for 20 kHz, and 30 kHz systems and 101-063-618 for 40 kHz systems.</p>

Figure 5.12 Assembling the Acoustic Stack

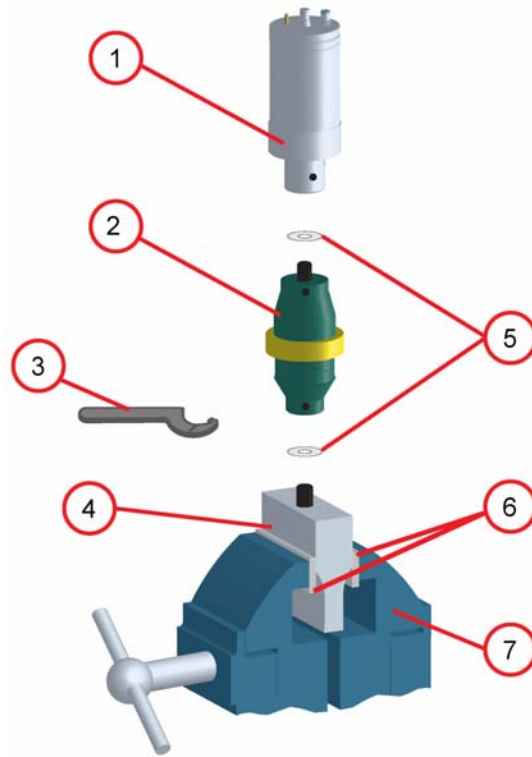

Table 5.11 Acoustic Stack Description

Item	Description
1	Converter
2	Booster
3	Spanner (provided)
4	Horn
5	See stack assembly procedure
6	Vise Jaw protectors (aluminum or soft metal)
7	Vise

Table 5.12 Stack Torque Values

Frequency	Torque
20 kHz	220 in·lb (24.85 N·m)
30 kHz	185 in·lb (21 N·m)
40 kHz	95 in·lb (10.73 N·m)

Table 5.13 Tools

Tool	EDP Number
20 kHz, and 30 kHz Torque Wrench Kit	101-063-787
40 kHz Torque Wrench	101-063-618
20 kHz Spanner Wrench	101-118-039
30 kHz Spanner Wrench	201-118-033
40 kHz Spanner Wrench	201-118-024
Silicone Grease	101-053-002
Mylar Plastic Film Washers (20 kHz)	100-063-357
Mylar Plastic Film Washers (30 kHz)	100-063-632

5.5.1 For a 20 kHz System

Table 5.14 20 kHz System

Step	Action
1	Ensure that the mating surfaces of the converter, booster, and horn are clean, and that the threaded holes are free of foreign material.
2	Install a single Mylar plastic film washer (matching the size of the washer to the stud) to each interface.
3	Assemble the converter to the booster and the booster to the horn.
4	Torque to 220 in·lb (24.85 N·m) at each interface.

5.5.2 For a 30 kHz System

Table 5.15 30 kHz System

Step	Action
1	Ensure that the mating surfaces of the converter, booster, and horn are clean, and that the threaded holes are free of foreign material.
2	Install a single Mylar plastic film washer (matching the size of the washer to the stud) to each interface.
3	Assemble the converter to the booster and the booster to the horn.
4	Torque to 185 in·lb (21 N·m) at each interface.

5.5.3 For a 40 kHz System

Table 5.16 40 kHz System

Step	Action
1	Ensure that the mating surfaces of the converter, booster, and horn are clean, and that the threaded holes are free of foreign material.
2	Coat each interface surface with a thin film of silicon grease - but do not apply silicon grease to a threaded stud or tip.
3	Assemble the converter to the booster and the booster to the horn.
4	Torque to 95 in·lb (10.73 N·m) at each interface.

5.5.4 Connecting Tip to Horn

1. Ensure that the mating surfaces of the tip and horn are clean. Remove any foreign matter from the threaded stud and hole.
2. Hand assemble the tip to the horn. Assemble dry. Do not use any silicone grease.
3. Use the spanner wrench and an open-end wrench (refer to [Figure 5.13](#)) and tighten to the following torque tip specifications:

Figure 5.13 Connecting Tip to Horn

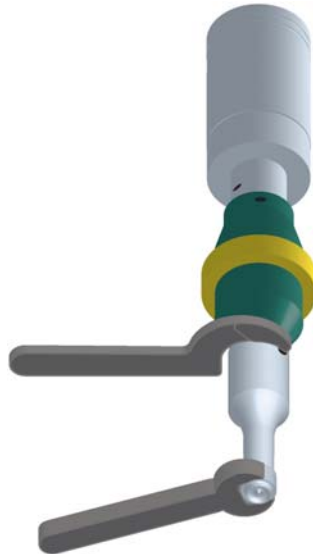

Table 5.17 Tip to horn torque values

Tip Thread	Torque
Tip Thread	Torque
1/4 - 28	110 in·lbs (12.42 N·m)
3/8 - 24	180 in·lbs (20.33 N·m)

5.6 Converter Cooling

Converter performance and reliability can be adversely affected if the converter ceramics are subjected to temperatures above 140° F (60° C). The converter front driver temperature should not exceed 122° F (50° C).

To prolong converter life and maintain a high degree of system reliability, the converter should be cooled with clean, dry, compressed air, particularly if your application calls for continuous ultrasonic operation. Converter cooling is especially critical in 40 kHz applications.

Use one of the following procedures to determine if a converter is operating close to the maximum allowable temperature. Check converter temperature immediately after substantial machine operation and without power applied to the horn.

- Press a pyrometer probe (or similar temperature measuring device) against the front driver of the converter assembly. Wait for the probe to reach the temperature of the shell. If the temperature is 120° F (49° C) or higher, the converter requires a cooling air stream.
- If a temperature measuring device is unavailable, use your hand to feel the shell of the converter. If the converter is hot to touch, the converter requires a cooling air stream.

High duty cycles require additional cooling for the converter. System average power must be limited to the specified continuous maximum. Higher peak power, up to the maximum acceptable power limit, with an on time of up to 10 seconds may be obtained, if appropriate off time ensures that, on average, the continuous duty maximum power is not exceeded.

Table 5.18 Continuous Duty Max. Power & Full Power Duty Cycle

Configuration	Continuous Duty Max. Power	Full Power Duty Cycles
20 kHz / 4000 W	2000 W	5 s on 15 s off (25% Duty Cycle)
30 kHz / 1500 W	800 W	2 s on 2 s off (50% Duty Cycle)
40 kHz / 800 W	400 W	10 s on 10 s off (50% Duty Cycle)

If converter cooling is required, use the following steps:

Table 5.19 Converter Cooling Procedure

Step	Action
1	Start with a 50 psi (345 kPa) air source or higher from a 0.06 in (1.5 mm) I.D. orifice
2	Perform a run of welding operations.
3	Immediately after completing the welding run, check the converter temperature.
4	If the converter is still too hot, increase the diameter of the orifice in small increments until the temperature falls within the ranges in the chart.

A 0.06 in (1.5 mm) orifice at 50 psi (345 kPa) will result in a reading of 80 ft³ (2.26 m³) per hour. This should be sufficient to cool most operations requiring a cooling air stream. In continuous welding operations, or applications with longer duty cycles, it may be necessary to cool the horn as well as the converter. Horns may require cooling because of the heat transfer from contacting the work piece.

5.7 Testing the Installation

To test the power supply follow the procedure described in [6.7 Ultrasonics Test Procedure](#) in [Chapter 6: Operation](#)

5.8 Still Need Help?

Branson is pleased that you chose our product and we are here for you! If you need parts or technical assistance with your DCX HD Power Supply system, call your local Branson representative. Please refer to [1.3 How to Contact Branson](#) for a list of Branson key contacts.



Chapter 6: Operation

6.1	Activating Ultrasonic Power	64
6.2	Setting the Amplitude.	65
6.3	Resetting the Power Supply Alarms.	67
6.4	Configuring the Power Supply Registers	68
6.5	LCD Bar Graph	72
6.6	Web Page Interface	75
6.7	Ultrasonics Test Procedure.	80

6.1 Activating Ultrasonic Power

On DCX Power Supplies, ultrasonic power activates after receiving an External Start signal at the corresponding user I/O. Ultrasonic power remains On until you turn off the power supply or the External Start signal. For default user I/O assignment see [5.3.6 User I/O Connections](#) For information on configuring the power supply user I/O refer to your DCX Series Web Page Interface Instruction Manual.

6.2 Setting the Amplitude

6.2.1 Using the Front Panel Controls

At power up the DCX HD Power Supply will display the last amplitude setting on the LCD.

Figure 6.1 LCD at Power Up

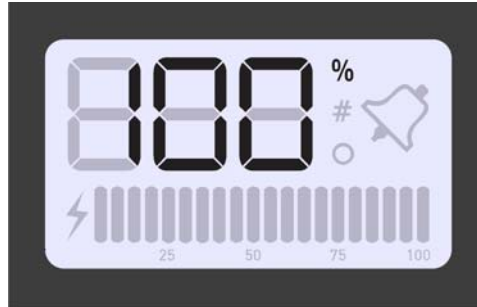

Table 6.1 Setting the Amplitude Using the Front Panel Controls

Step	Action	Reference
1	Press the Configuration key until the percentage icon (%) appears on the LCD.	
2	<p>Press and release the Up or Down arrow keys to select the desired amplitude at 1 % increments.</p> <p>Press and hold down the Up or Down arrow keys and the Amplitude will auto increment at 1 % increments every quarter of a second.</p> <p>After holding down an arrow key for four straight seconds, the amplitude will auto increment at 5 % increments every quarter of a second.</p>	

6.2.2 Using External Amplitude Control

When External Amplitude Control is enabled, the front panel amplitude control is disabled and the LCD displays three dashes (see [Figure 6.2](#) below).

Figure 6.2 LCD when in External Amplitude Control Mode

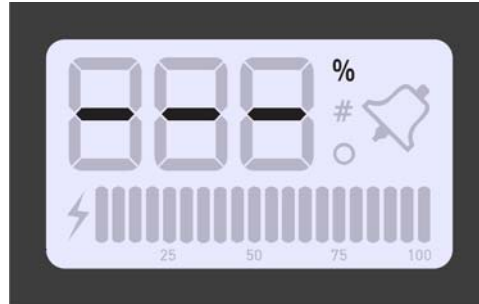

The ultrasonic amplitude can be controlled using one of the two analog input pins on the user I/O connector (pins 17 and 18). For information on configuring the power supply user I/O refer to your DCX Series Web Page Interface Instruction Manual.

6.2.3 Using the Web Page Interface

The ultrasonic amplitude can be set to a user specified value using the web page interface. For more information, refer to your DCX Series Web Page Interface Instruction Manual.

6.3 Resetting the Power Supply Alarms

You need to reset the weld system when you get an overload. When there is an overload, the alarm icon appears on the front panel LCD and the General Alarm output on the user I/O connector becomes active. The procedure for resetting the power supply depends on the power supply alarm settings. Refer to [Table 6.2](#) for reset procedures.

Table 6.2 Resetting the DCX HD Power Supply

Alarm Setting	Reset Procedures
Latching Alarms	Press the front panel Reset key. You can also send an External Reset signal.
Non-Latching Alarms	Remove and re-apply the start signal.

NOTICE	
	Alarm circuitry requires at least 20 ms before restarting ultrasonic power.

For more information on interfacing the DCX HD Power Supply using the user I/O connections refer to [5.3.6 User I/O Connections](#) in [Chapter 5: Installation and Setup](#).

6.4 Configuring the Power Supply Registers

At power up the DCX HD Power Supply will display the last amplitude setting, this is indicated by the percentage icon (%) on the LCD. Refer to [Figure 6.1](#).

Table 6.3 Steps to configure the Power Supply Registers

Step	Action	Reference
1	<p>Press the Configuration key until the number icon (#) appears on the LCD.</p> <p>The power supply will display register 101 the first time you access the registers. (If you access the registers again the last selected register will be displayed.)</p>	
2	<p>Press and release the Up or Down arrow keys to select the desired register. For a detailed description of available registers refer to Table 6.4.</p>	
3	<p>Once you have reached the desired register, press the Configuration key. The register value will be displayed, this is indicated by the circle icon.</p>	

Table 6.3 Steps to configure the Power Supply Registers

Step	Action	Reference
4	<p>Press and release the Up or Down arrow keys to enter the desired value at 1 increments.</p> <p>Press and hold down the Up and Down arrow keys and the value will auto increment at 1 increments every quarter of a second.</p> <p>After holding down an arrow key for four straight seconds, the value will auto increment at 5 increments every quarter of a second.</p> <p>Or press the Reset key to enter the default value. For detailed default values of available registers refer to Table 6.4.</p>	
5	<p>Press the Configuration key to save the value. The current amplitude setting will be displayed.</p>	

6.4.1 Power Supply Registers

Table 6.4 Registers

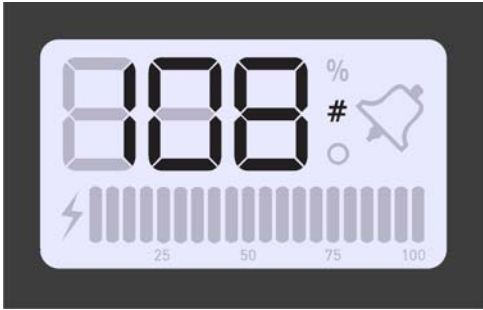
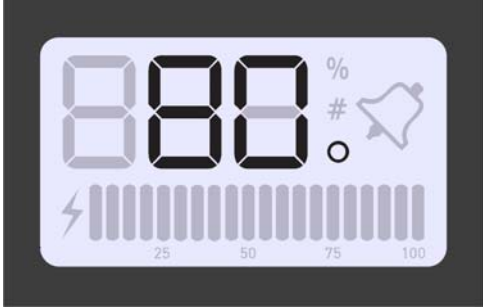
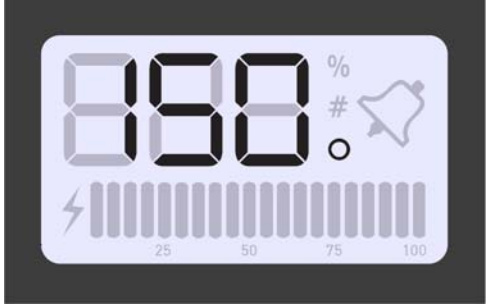
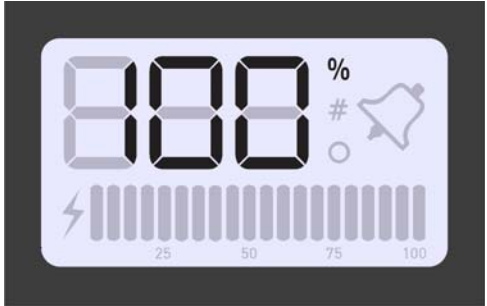
Register	Description	Default Value	Max. Value	Min. Value
101	Software version	N/A	999	0
102	Bar graph identification after weld complete 0: Power 1: Frequency	0	1	0
103	Latching Alarms (reset required) 0: Off 1: On	0	1	0

Table 6.4 Registers

Register	Description	Default Value	Max. Value	Min. Value
104	External amplitude control - user analog input 0: Off 1: On	0	1	0
105	Start ramp time (ms)	80	999	1
106	Store frequency at end of weld 0: Off 1: On	1	1	0
107	Power-on 0: Off 1: Seek 2: Scan 3: Stack Adjustment	3	3	0
108	Seek ramp time (ms)	80	999	1
109	Timed seek (every 60 seconds) 0: Off 1: On	0	1	0
110	Seek time (ms)	500	999	1
111	Frequency offset 0: Off 1: On	0	1	0
115	Restore defaults 0: Off 1: Weld presets only 2: System defaults	0	2	0
116	IP address - 1	192	255	0
117	IP address - 2	168	255	0
118	IP address - 3	10	255	0
119	IP address - 4	100	255	0
120	Gateway for IP address 1	192	255	0
121	Gateway for IP address 2	168	255	0
122	Gateway for IP address 3	10	255	0
123	Gateway for IP address 4	1	255	0
124	Subnet Mask for IP address 1	255	255	0
125	Subnet Mask for IP address 2	255	255	0

Table 6.4 Registers

Register	Description	Default Value	Max. Value	Min. Value
126	Subnet Mask for IP address 3	255	255	0
127	Subnet Mask for IP address 4	0	255	0
128	DHCP Setting 0: Server 1: Client 2: Static 3: Restore registers 116–128 to default	2	3	0
129	Amplitude	100	100	10

6.5 LCD Bar Graph

While ultrasonic power is active the LCD will always display the power value on the 20-segment LCD bar graph as a percentage of the maximum output power.

At the end of a weld or test cycle, the bar graph is factory set to represent the cycle's peak power as a percentage of the maximum output power.

The power supply can also be configured to show a single bar on the LCD bargraph to represent the stack operating frequency stored at the end of each weld or test cycle. This option can be used to troubleshoot operating frequency changes as a result of heating effects, coupling, tooling wear, etc. When using this feature the option "Store frequency at end of weld" must also be enabled.

For information on how to set the power supply registers see [6.4 Configuring the Power Supply Registers](#).

6.5.1 Power Bar Graph Interpretation

The lightning bolt left of the bar graph indicates ultrasonic power is running. Each of the segments represent 5 % increments of the maximum output power. The segments will only appear if the output power has exceeded the value represented. For example if the power is 4 % only the lightning bolt will be on. When it reaches 5 % the first bar graph segment will appear.

Power Bar Graph Interpretation Examples

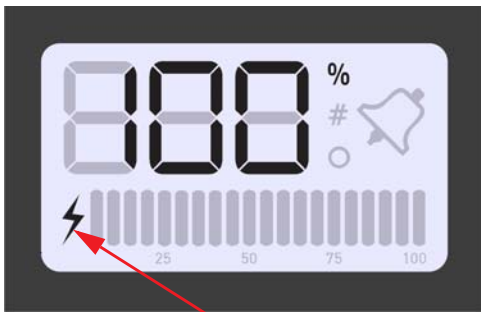

In this example only the lightning bolt appears left of the bargraph. This means power is between 0 % and 5 %. If the power supply is 800 W the actual output power is between 0 W and 40 W.

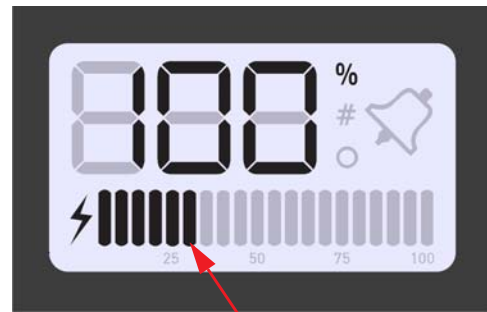

In this example the first six segments appear on the bargraph. This means power is between 30 % and 35 %. If the power supply is 800 W, the actual output power is between 240 W and 280 W.

6.5.2 Frequency Bar Graph Interpretation

The actual frequency depends on the power supply's operating frequency. Use [Table 6.5](#) to [Table 6.7](#) below to interpret frequency bar graph readings.

NOTICE	
	<p>If there is a test overload or an external memory reset signal is received, then the 50% segment will be displayed and blinking.</p>

Table 6.5 Frequency Bar-Graph Interpretation - 20 kHz (50 Hz Segment)

20 kHz (50 Hz/Segment)	
1	19,475-19,524
2	19,525-19,574
3	19,575-19,624
4	19,625-19,674
5 (25%)	19,675-19,724
6	19,725-19,774
7	19,775-19,824
8	19,825-19,874
9	19,875-19,924
10 (50%)	19,925-19,974
11	19,975-20,024
12	20,025-20,074
13	20,075-20,124
14	20,125-20,174
15 (75%)	20,175-20,224
16	20,225-20,274
17	20,275-20,324
18	20,325-20,374
19	20,375-20,424
20 (100%)	20,425-20,474

Table 6.6 Frequency Bar-Graph Interpretation - 30 kHz (76 Hz Segment)

30 kHz (76 Hz/Segment)	
1	29,278-29,353
2	29,357-29,429
3	29,430-29,501
4	29,502-29,581
5 (25%)	29,582-29,657
6	29,658-29,733
7	29,734-29,809
8	29,810-29,885
9	29,886-29,961
10 (50%)	29,962-30,037
11	30,038-30,113
12	30,114-30,189
13	30,190-30,265
14	30,266-30,341
15 (75%)	30,342-30,417
16	30,418-30,493
17	30,494-30,569
18	30,570-30,645
19	30,646-30,721
20 (100%)	30,722-30,797

Table 6.7 Frequency Bar-Graph Interpretation - 40 kHz (100 Hz/Segment)

40 kHz (50 Hz/Segment)	
1	38,950-39,049
2	39,050-39,149
3	39,150-39,249
4	39,250-39,339
5 (25%)	39,350-39,449
6	39,450-39,549
7	39,550-39,649
8	39,650-39,749
9	39,750-39,849
10 (50%)	39,850-39,949
11	39,950-40,049
12	40,050-40,149
13	40,150-40,249
14	40,250-40,349
15 (75%)	40,350-40,449
16	40,450-40,549
17	40,550-40,649
18	40,650-40,749
19	40,750-40,849
20 (100%)	40,850-40,949

Figure 6.3 Frequency Bar Graph Interpretation Examples

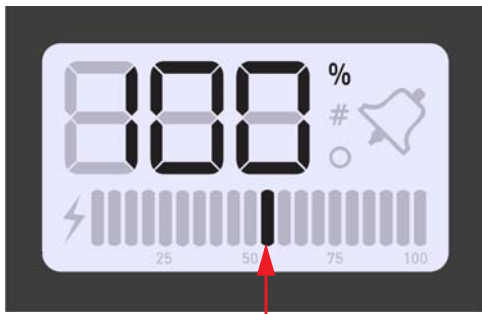

In this example the bar is located in the 11th segment. If the power supply is a 20 kHz unit, the stack is running in the frequency range of 19 975 Hz to 20 024 Hz.

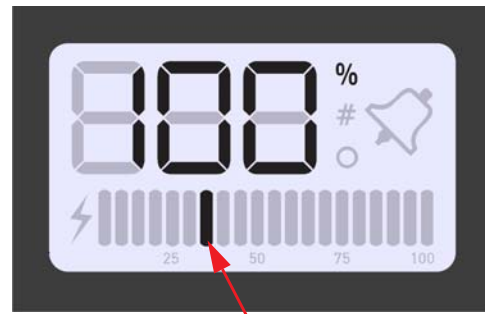

In this example the bar is located in the 7th segment. If the power supply is a 20 kHz unit, the stack is running in the frequency range of 19 775 Hz to 19 824 Hz.

6.6 Web Page Interface

The DCX HD Power Supply web Page Interface provides access, via Ethernet connection, to power supply information, diagnostics, and configuration web pages. Communication can be established point-to-point or through a local area network.

6.6.1 System Requirements

To connect to the DCX Web Page Interface you will need a PC running a Windows® operating system with an Internet Explorer® web browser software (versions 7 and up).

6.6.2 Connecting to the Web Page Interface

NOTICE	
	<p>The DCX Power Supply is not compatible with network scanning software. If your local network uses these types of programs, the DCX Power Supply IP address must be placed in an exclusion list.</p>

NOTICE	
	<p>A shielded Ethernet cable should be used to connect to the DCX Power Supply Web Page Interface to prevent possible EMI (Electromagnetic Interference) issues.</p>

6.6.2.1 Point to Point Connection (Windows Vista and Windows 7)

To connect directly to the DCX Power Supply Web Page Interface using a PC with Windows Vista® or Windows 7® operating system, complete the following steps:

1. Connect the power supply to a computer via the Ethernet port
2. Turn on the power supply
3. On your PC, click on the Windows logo on the task bar and select **Control Panel**
4. Select **View Large Icons** on the top right corner
5. Select **Network and Sharing Center**
6. Select **Change adapter settings**

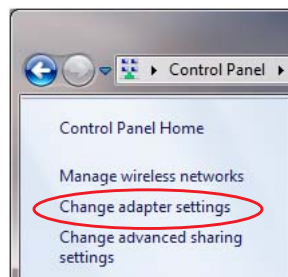

7. Right click on **Local Area Connection** and select **Properties** to bring up the **Networking** tab

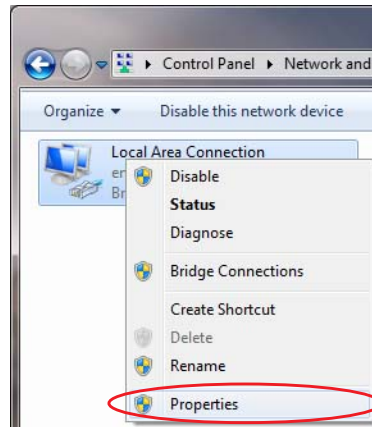

8. Highlight **Internet Protocol Version 4 (TCP/IPv4)** from the list and click on **Properties**

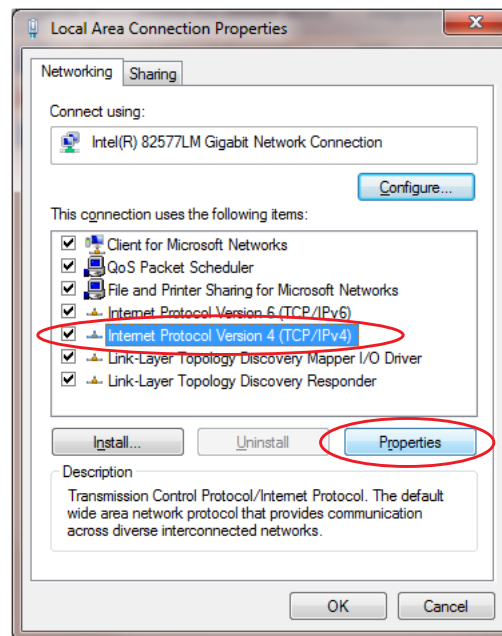

9. Use the following IP address:
IP address: 192.168.10.101
Subnet mask: 255.255.255.0

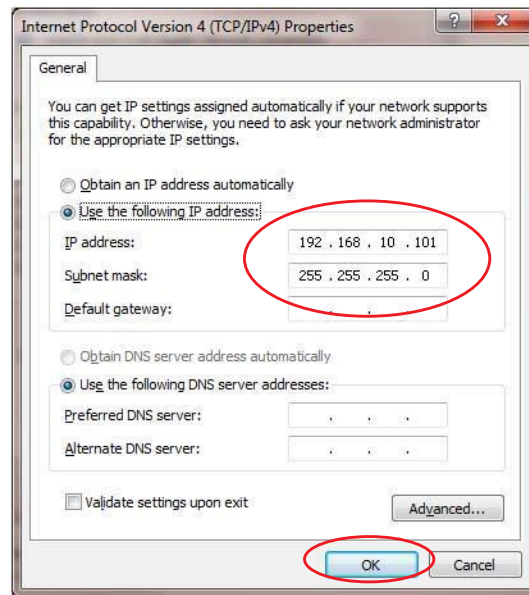

10. Click OK. Close the rest of the dialog boxes
 11. Open the Internet Explorer web browser (version 7 and up)
 12. In the address bar type the following address: <http://192.168.10.100>. Press Enter
 13. This will bring up the DCX Web Page interface
 14. Enter a user ID number (any number up to 9 digits long)

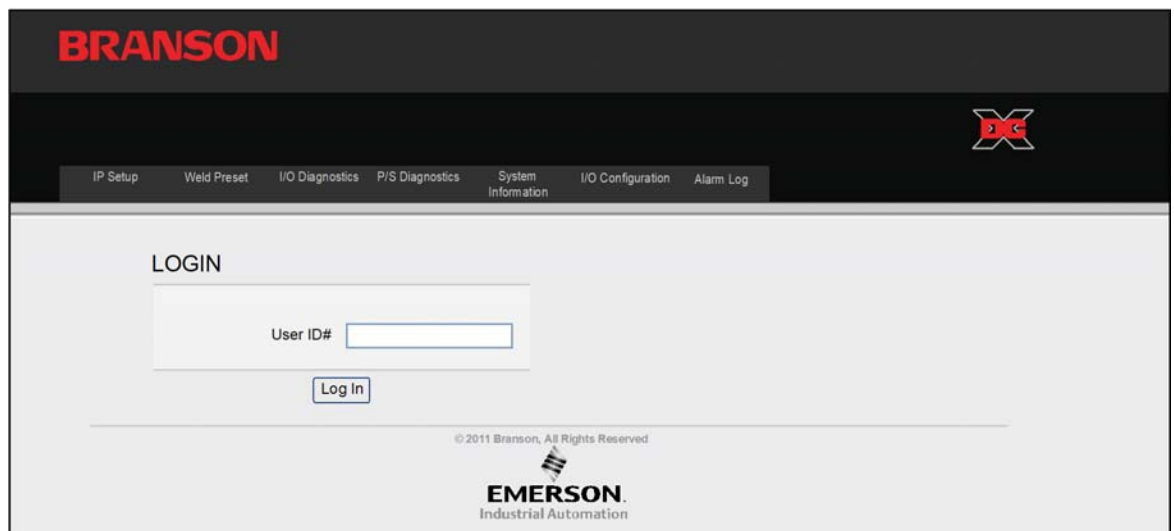

6.6.2.2 Point to Point Connection (Windows XP)

To connect directly to the DCX Power Supply Web Page Interface using a PC with Windows XP® operating system, complete the following steps:

1. Connect the power supply to a computer via the Ethernet port
2. Turn on the power supply
3. On your PC, select **Start > Control Panel**

4. Select **Switch to Classic View** on the top left corner

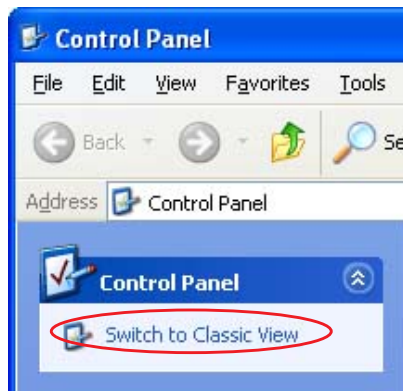

5. Select **Network Connections**
6. Right click on **Local Area Connection** and select **Properties** to bring up the **General Tab**

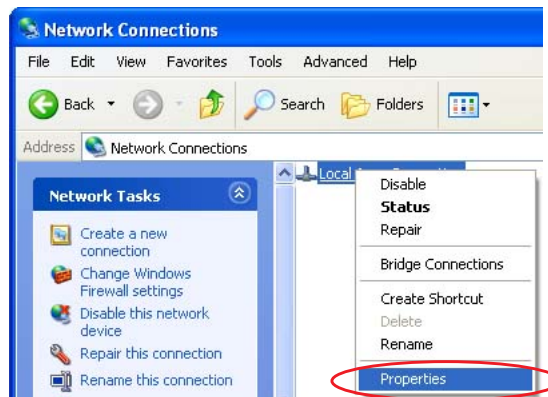

7. Highlight **Internet Protocol (TCP/IP)** from the list and click on **Properties**

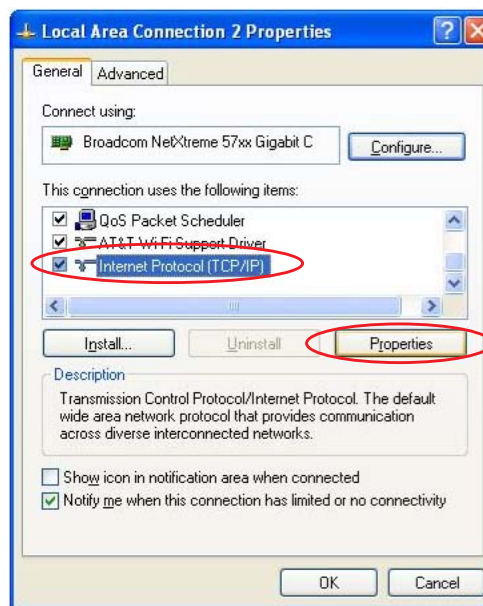

8. Use the following IP address:
IP address: 192.168.10.101
Subnet mask: 255.255.255.0

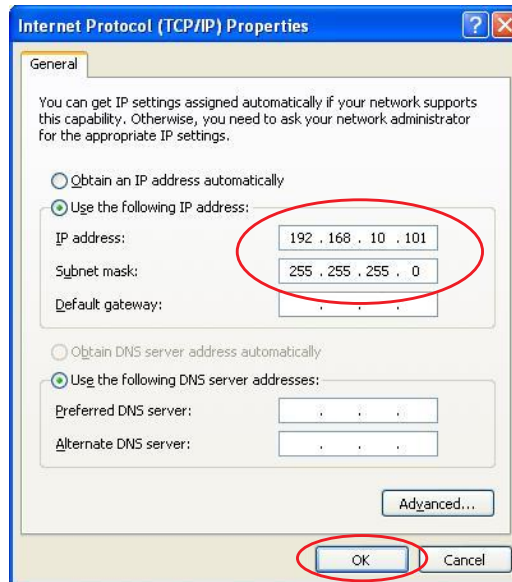

9. Click OK. Close the rest of the dialog boxes
 10. Open the Internet Explorer web browser (version 7 and up)
 11. In the address bar type the following address: <http://192.168.10.100>. Press Enter
 12. This will bring up the DCX Web Page interface
 13. Enter a user ID number (any number up to 9 digits long).

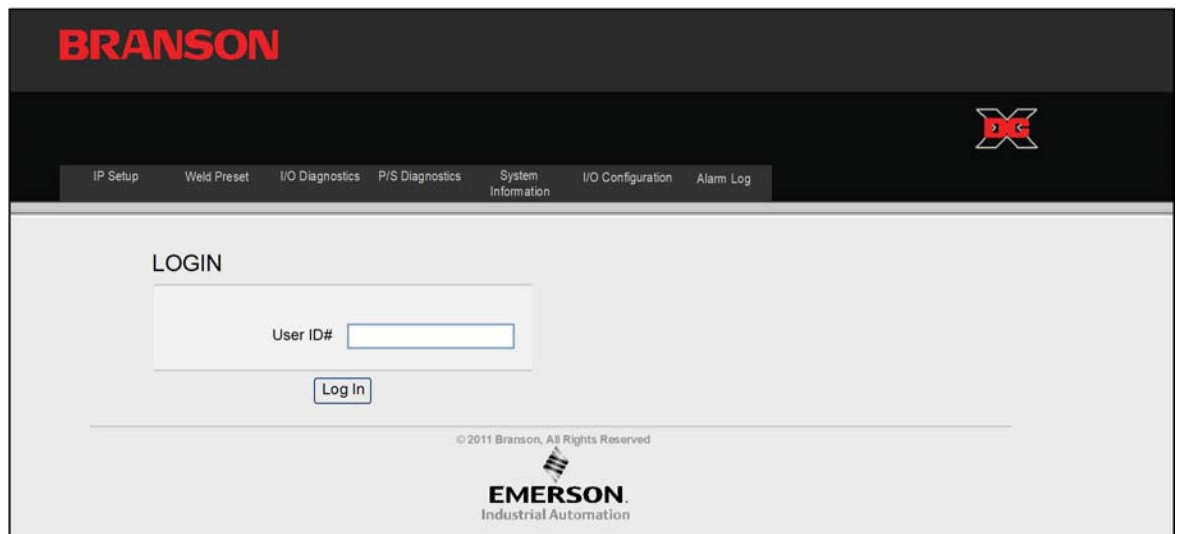



6.6.3 Using the Web Page Interface

For complete instructions detailing the web page interface consult the DCX HD Power Supply Web Page Interface Instruction Manual.

6.7 Ultrasonics Test Procedure

The Ultrasonics Test function measures ultrasonic power dissipated by the ultrasonic stack with no load. Autotune with Memory (ATM) function ensures that the power supply does not require any manual adjustments. The ultrasonics test procedure involves an automatic matching of the frequency of the power supply to the frequency of the converter-booster-horn stack (stack).

WARNING	High Voltage Hazard
	<p>Ensure that no one is in contact with the horn when testing the power supply.</p> <p>Do not cycle the welding system if either the RF cable or converter is disconnected.</p>

WARNING	High Voltage Hazard
	<p>Ensure the power supply is properly connected, as indicated in 5.3 Installation Steps.</p>

6.7.1 Using the Front Panel Controls

Table 6.8 Power Supply Ultrasonic Test Procedure (Front Panel)



Step	Action	Reference
1	Turn on the power supply. The front panel Power LED and LCD turn on.	

Table 6.8 Power Supply Ultrasonic Test Procedure (Front Panel)

Step	Action	Reference
2	Press the test key for 1-2 seconds, then release. The Sonics Active indicator appears while the test key is pressed. If the power supply alarm indicator does not appear, the test procedure is finished.	 <p>Sonics Active Indicator</p>
3	If the alarm indicator appears, press the alarm reset key and repeat step 2 one time only. If the alarm persists, refer to 7.5 Troubleshooting	 <p>Alarm Indicator</p>

6.7.2 Using the I/O Connections

Table 6.9 Power Supply Ultrasonic Test Procedure (User I/O)

Step	Action	Reference
1	Wire the necessary I/O signals as shown on Table 6.4 , or using a similar setup.	Refer to Figure 6.4 below.
2	Turn on the power supply. The front panel Power LED should turn on. Ready Signal should become active.	 <p>Power On LED</p>

Table 6.9 Power Supply Ultrasonic Test Procedure (User I/O)

Step	Action	Reference
3	Send an External Start signal for 1-2 seconds. The Sonics Active output will become active and the Sonics Active indicator appears while the External Start Signal is present. If the General Alarm output/ alarm indicator do not become active, the test procedure is finished	 <p>Sonics Active Indicator</p>
4	If the General Alarm output/alarm indicator become active, send an External Reset signal and repeat step 2 one time only. If the alarm persists, refer to 7.5 Troubleshooting	 <p>Alarm Indicator</p>

Figure 6.4 Test Connections.



6.7.3 Using the Web page interface

Table 6.10 Power Supply Ultrasonic Test Procedure (Web Page Interface)

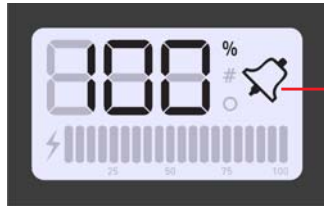
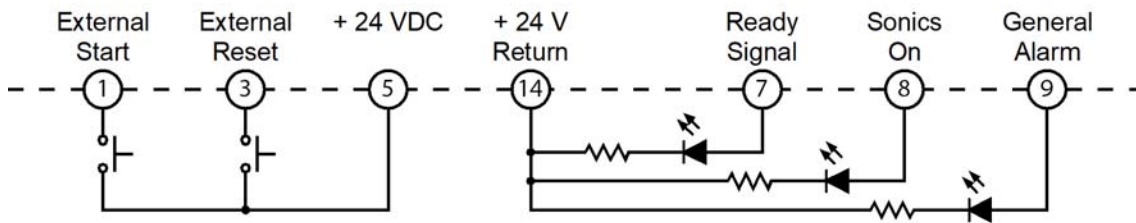
Step	Action
1	Turn on the power supply. The front panel Power LED should turn on.
2	Connect to the DCX Web Page Interface. See 6.6.2 Connecting to the Web Page Interface
3	<p>Go to the P/S Diagnostics tab. Press the Start Test button to start the test. Sonics will become active and the button will change to Stop Test. Press the button again to stop the test.</p> <p>If the OK - Memory Stored indicator becomes active the test procedure is finished.</p> <p>NOTICE Low level ultrasonic energy will remain active until the Stop Test button is pressed. If you close the web browser, ultrasonic energy will turn off automatically after 5 seconds.</p>
4	If the Overload - Memory Cleared indicator becomes active the test will be interrupted, press the Reset Overload button and repeat step 3 one time only. If the alarm persists, refer to 7.5 Troubleshooting

Chapter 7: Maintenance

7.1	General Maintenance Considerations	84
7.2	DCX HD Power Supply Preventive Maintenance	86
7.3	Calibration	91
7.4	Recommended Spare Stock	92
7.5	Troubleshooting	96
7.6	Cold Start Procedure	100

7.1 General Maintenance Considerations

WARNING	High Voltage Hazard
	<p>Power supplies produce high voltage. To avoid the possibility of an electrical shock, you should always power down your system prior to repairing any portion of it.</p>

CAUTION	General Warning
	<p>When performing maintenance on the welder, make sure that no other automated systems are active.</p>

NOTICE	
	<p>There are no customer replaceable components inside the power supply. Have all servicing done by a qualified Branson technician.</p>

NOTICE	
	<p>When returning printed circuit boards, make sure to enclose them in an anti-static package.</p>

NOTICE	
	<p>Connectors may not be keyed and wires may not be color-coded. Therefore, when disconnecting cables and wires, label them so you can reconnect them properly.</p>

NOTICE



To prevent circuit damage from electrostatic discharge, always service the power supply on a static-dissipative surface, while wearing a properly grounded wrist strap.

7.2 DCX HD Power Supply Preventive Maintenance

The following preventive measures help assure long term operation of your Branson DCX HD Power Supply equipment.

7.2.1 Periodically Clean the Equipment

NOTICE	
	<p>Use only anti-static vacuum cleaners to prevent damage from electrostatic discharge to your power supply.</p>

Air is continuously drawn into the power supply. Periodically disconnect the unit from power, remove the cover and vacuum out any accumulated dust and debris. Remove material adhering to:

- The fan blades and motor
- Power supply heat sink cooling fins
- Transformers
- Circuit boards
- Cooling intake vents
- Exhaust ports

External covers may be cleaned with a damp sponge or cloth using a solution of mild soap and water. Do not allow cleaning solution to enter the unit.

To prevent rust in areas of high humidity, exposed steel surfaces, may require a very light film of rust preventing oil, such as WD-40®.

7.2.2 Recondition the Stack (Converter, Booster, and Horn)

NOTICE	
	<p>Never clean the converter-booster-horn stack mating surfaces by using a buffing wheel or by filing.</p>

Welding system components work most efficiently when the converter-booster-horn stack mating surfaces are flat, in solid contact, and free from fretting corrosion. Poor contact between mating surfaces wastes power output, makes tuning difficult, increases noise and heat, and may cause damage to the converter.

For standard 20 kHz and 30 kHz products, a Branson Mylar polyester film washer should be installed between the horn and booster, and horn and converter. Replace the washer if

torn or perforated. Stacks using Mylar plastic film washers should be inspected every three months.

Stacks used with silicone grease, as with certain 20 kHz, 30 kHz and all 40 kHz products, should be periodically reconditioned to eliminate fretting corrosion. A stack using silicone grease should be inspected every two weeks for corrosion. When experience is gained for specific stacks, the inspection interval can be adjusted to a longer or shorter period as required.

Stack Reconditioning Procedure

To recondition stack mating surfaces, take the following steps:

Table 7.1 Stack Reconditioning Procedure

Step	Action
1	Disassemble the converter-booster-horn stack and wipe the mating surfaces with a clean cloth or paper towel.
2	Examine all mating surfaces. If any mating surface shows corrosion or a hard, dark deposit, recondition it.
3	If necessary, remove the threaded stud from the part.
4	Tape a clean sheet of #400 (or finer) grit emery cloth to a clean, smooth, flat surface (such as a sheet of plate glass), as in Figure 7.1 .
5	Place the interface surface on the emery cloth. Grasp the part at the lower end, with your thumb over the spanner-wrench hole, and lap the part in a straight line across the emery cloth. Do not apply downward pressure — the weight of the part alone provides sufficient pressure.
6	Lap the part, two or three times, in the same direction against the emery cloth. (See Figure 7.1 .)
7	Rotate the part 120 degrees, placing your thumb over the spanner-wrench hole, and repeat the lapping procedure in step 6.
8	Rotate the part another 120 degrees to the next spanner-wrench hole, and repeat the lapping procedure in step 6.
9	Re-examine the mating surface. If necessary, repeat steps 2-5 until you remove most of the contaminant. Remember, this should not require more than two to three complete rotations for an aluminum horn or booster; a titanium component may require more rotations.
10	<p>Before re-inserting a threaded stud in an aluminum booster or horn: Using a file card or wire brush, clean any aluminum bits from the knurled end of the stud. Using a clean cloth or towel, clean the threaded hole. Examine the knurled end of the stud. If worn, replace the stud. Also, examine the stud and threaded hole for stripped threads.</p> <p>NOTICE Threaded studs cannot be reused in titanium horns or boosters. Replace all studs in these components.</p>
11	Assemble and install the stack.

Figure 7.1 Reconditioning Stack Mating Surfaces

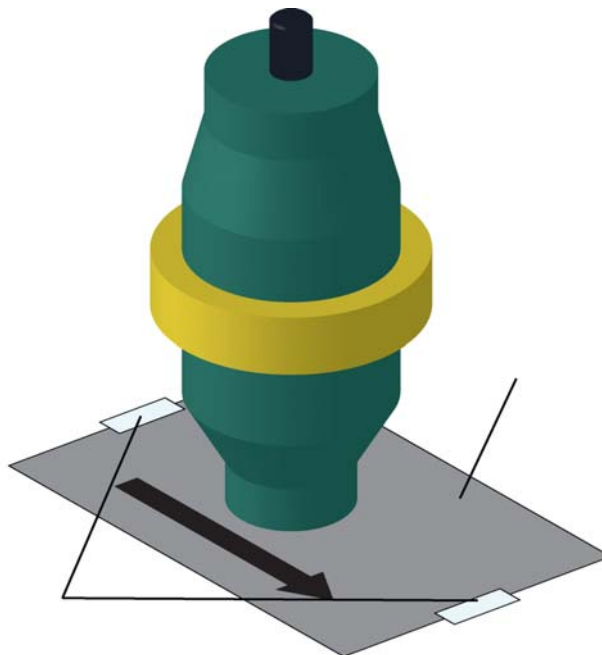

Table 7.2 Reconditioning Stack Mating Surfaces

Item	Description
1	Tape
2	#400 Emery Cloth

7.2.2.1 Stack Reassembly Process

Table 7.3 Stack Torque Values

Frequency	Torque
20 kHz	220 in·lb (24.85 N·m)
30 kHz	185 in·lb (21 N·m)
40 kHz	95 in·lb (10.73 N·m)

For a 20 kHz System

Table 7.4 Stack Reassembly for a 20 kHz System

Step	Action
1	Clean the mating surfaces of the converter, booster, and horn. Remove any foreign material from the threaded holes.
2	Install the threaded stud into the top of the booster. Torque to 450 in·lb (50.84 N·m). If the stud is dry, apply 1 or 2 drops of a light lubricating oil before installing.
3	Install the threaded stud into the top of the horn. Torque to 450 in·lb (50.84 N·m). If the stud is dry, apply 1 or 2 drops of a light lubricating oil before installing.
4	Install a single Mylar plastic film washer (matching the size of the washer to the stud) to each interface.
5	Assemble the converter to the booster and the booster to the horn.
6	Torque to 220 in·lb (24.85 N·m) at each interface.

For a 30 kHz System

Table 7.5 Stack Reassembly for a 30 kHz System

Step	Action
1	Clean the mating surfaces of the converter, booster, and horn. Remove any foreign material from the threaded holes.
2	Install the threaded stud into the top of the booster. Torque to 290 in·lb (32.76 N·m). If the stud is dry, apply 1 or 2 drops of a light lubricating oil before installing.
3	Install the threaded stud into the top of the horn. Torque to 290 in·lb (32.76 N·m). If the stud is dry, apply 1 or 2 drops of a light lubricating oil before installing.
4	Install a single Mylar plastic film washer (matching the size of the washer to the stud) to each interface.
5	Assemble the converter to the booster and the booster to the horn.
6	Torque to 185 in·lb (21 N·m) at each interface.

For a 40 kHz System

Table 7.6 Stack Reassembly for a 40 kHz System

Step	Action
1	Clean the mating surfaces of the converter, booster, and horn. Remove any foreign material from the threaded holes.
2	Apply a drop of Loctite®* 290 threadlocker (or equivalent) to the studs for the booster and horn.
3	Install the threaded stud into the top of the booster. Torque to 70 in·lb (7.91 N·m). Remove excess Loctite 290 threadlocker from the booster face and let cure for 30 minutes.
4	Install the threaded stud into the top of the horn. Torque to 70 in·lb (7.91 N·m). Remove excess Loctite 290 threadlocker from the horn face and let cure for 30 minutes.
5	Coat each interface surface with a thin film of silicon grease - <i>but do not apply silicon grease to a threaded stud or tip.</i>
6	Torque to 95 in·lb (10.73 N·m) at each interface.

* Loctite is a registered trademark of Henkel Corporation, U.S.A.

Table 7.7 Stud Torque Values

Used on	Stud Size	Torque	EDP #
20 kHz	1/2 in x 20 x 1-1/4 in	450 in·lb, 50.84 N·m	100-098-370
	1/2 in x 20 x 1-1/2 in		100-098-123
30 kHz	3/8 in x 24 x 1 in	290 in·lb, 32.76 N·m	100-298-170R
40 kHz*	M8 x 1.25	70 in·lb, 7.91 N·m	100-098-790

* Add a drop of Loctite 290 threadlocker to the stud. Torque and let cure for 30 minutes before using.

7.2.3 Routine Component Replacement

The lifetime of certain parts is based on the number of cycles the unit has completed, or on hours of operation. Change cooling fans at 20,000 hours, and filter kits as required.

7.3 Calibration

This product does not normally require scheduled calibration. However, if you are operating under any type of regulatory requirements, you may need to calibrate the equipment according to that schedule and set of standards. Contact Branson for details.

7.4 Recommended Spare Stock

This section provides lists of replacement parts, system cables, and suggested spares.

7.4.1 System Cables

You can order the following cables:

Table 7.8 DCX HD Power Supply System Cables

P/N	Description
100-240-383	Cable, RF 8 ft (2.5 m)
100-240-384	Cable, RF 15 ft (4.5 m)
100-240-385	Cable, RF 25 ft (7.5 m)
100-240-386	Cable, RF 50 ft (15 m)
100-240-387	Cable, RF right angle 8 ft (2.5 m)
100-240-388	Cable, RF right angle 15 ft (4.5 m)
100-240-389	Cable, RF right angle 25 ft (7.5 m)
100-240-390	Cable, RF right angle 50 ft (15 m)
100-240-391	Cable, RF adaptor for CR20 converter 3 ft (0.9 m)
100-240-392	Cable, User I/O 25 ft (7.5 m)
100-240-393	Cable, User I/O 50 ft (15 m)
200-240-396	Cable Ethernet Cat 5e 7 ft (2.1 m)
100-240-397	Cable, RF adaptor for 4TR converter 3 ft (0.9 m)

7.4.2 Suggested Spares

Table 7.9 Suggested Spares

Description	EDP#	1-4 Units	6-12 Units	14+ Units
Converter	Refer to Table 7.10	0	1	2
Booster	Refer to Table 7.11	0	1	2
Horn	As Ordered	1	1	2
Studs	Refer to Table 7.12	4	6	8
Mylar Plastic Film Washer Kit	Refer to Table 7.12	1	1	1

7.4.3 Converters Compatible with the DCX HD Power Supply

Table 7.10 Converters Compatible with the DCX HD Power Supply

Where used	Model	Connector	Part Number
20 kHz / 4000 W	CR-20*	3-pin MS connector	101-135-060R
	CR-20S	SHV connector	125-135-115R
	CR-20C	SHV connector with 3 ft (0.9 m) cable	159-135-210R
	CH-20S (932 AH SPL)	SHV connector	159-135-075R
	CH-20C	SHV connector with 3 ft (0.9 m) cable	159-135-211R
	CS-20S	SHV connector	159-135-138R
	CS-20C	SHV connector with 3 ft (0.9 m) cable	159-135-209R
30 kHz / 1500 W	CR-30S	SHV connectors	101-135-081R
	CR-30C	SHV connector with 3 ft (0.9 m) cable	159-135-213R
	CH-30S	SHV connector	101-135-071R
	CH-30C	SHV connector with 3 ft (0.9 m) cable	159-135-214R
	CS-30S	SHV connector	159-135-110R
	CS-30C	SHV connector with 3 ft (0.9 m) cable	159-135-212R
40 kHz / 800 W	4TR	3-pin MS connector	101-135-042R
	4TP	SHV connector (platen mount)	101-135-068R
	CR-40S (4TH)	SHV connector	101-135-067R
	CR-40C	SHV connector with 3 ft (0.9 m) cable	159-135-215R

* Requires a special adaptor cable. See [Table 7.8](#).

7.4.4 DCX HD Power Supply Compatible Boosters

Table 7.11 DCX HD Power Supply Compatible Boosters

Type of Booster	Description	Part Number
Solid Mount (1/2-20 horn stud) 20 kHz	Titanium, 1:0.6 (Purple)	101-149-095
	Titanium, 1:1 (Green)	101-149-096
	Titanium, 1:1.5 (Gold)	101-149-097
	Titanium, 1:2 (Silver)	101-149-098
	Titanium, 1:2.5 (Black)	101-149-099

Table 7.11 DCX HD Power Supply Compatible Boosters

Type of Booster	Description	Part Number
Solid Mount (M8 x 1.25 horn stud) 40 kHz	Titanium, 1:0.6 (Purple)	109-041-178
	Titanium, 1:1 (Green)	109-041-177
	Titanium, 1:1.5 (Gold)	109-041-176
	Titanium, 1:2 (Silver)	109-041-175
	Titanium, 1:2.5 (Black)	109-041-174
Standard Series (1/2-20 horn stud) 20 kHz	Aluminum, 1:0.6 (Purple)	101-149-055
	Aluminum, 1:1 (Green)	101-149-051
	Aluminum, 1:1.5 (Gold)	101-149-052
	Aluminum, 1:2 (Silver)	101-149-053
	Titanium, 1:0.6 (Purple)	101-149-060
	Titanium, 1:1 (Green)	101-149-056
	Titanium, 1:1.5 (Gold)	101-149-057
	Titanium, 1:2 (Silver)	101-149-058
Standard Series (3/8-24 horn stud) 30 kHz	Titanium, 1:2.5 (Black)	101-149-103
	Titanium, 1:2 (Silver)	101-149-104
	Titanium, 1:1.5 (Gold)	101-149-105
	Titanium, 1:1 (Green)	101-149-106
Standard Series (M8 x 1.25 horn stud) 40 kHz	Aluminum, 1:0.6 (Purple)	101-149-087
	Aluminum, 1:1 (Green)	101-149-079
	Aluminum, 1:1.5 (Gold)	101-149-080
	Aluminum, 1:2 (Silver)	101-149-081R
	Aluminum, 1:2.5 (Black)	101-149-082
	Titanium, 1:1 (Green)	101-149-085
	Titanium, 1:1.5 (Gold)	101-149-086
	Titanium, 1:2 (Silver)	101-149-083
	Titanium, 1:2.5 (Black)	101-149-084

7.4.5 Other Items used with the DCX HD Power Supply

Table 7.12 Other Items used with the DCX HD Power Supply

Product	Description	Part No.
Silicone grease	For use with 40 kHz systems	101-053-002
Mylar Plastic Film Washers (for 20 kHz systems)	Kit, 10 each (1/2 in. and 3/8 in.)	100-063-357
	Kit, 150 each (1/2 in.)	100-063-471
	Kit, 150 each (3/8 in.)	100-063-472
Mylar Plastic Film Washers (for 30 kHz systems)	Kit, 10 each (3/8 in.)	100-063-632
	Kit, 150 each (3/8 in.)	100-063-712
Tool Kit	20 kHz (spanner wrench and 10 pc washer kit)	101-063-208R
	30 kHz (spanner wrench and 10 pc washer kit)	101-063-636R
	40 kHz (spanner wrench and silicone grease)	101-063-176R
Spanner wrench	20 kHz	101-118-039
	30 kHz	201-118-033
	40 kHz	201-118-024
Studs	1/2-20 x 1-1/4 (titanium horns)	100-098-370
	1/2-20 x 1-1/2 (aluminum horns, 20 kHz boosters)	100-098-123
	3/8-24 x 1 (30 kHz titanium horns and boosters)	100-298-170R
	M-8 x 1.25 (40 kHz horns and boosters)	100-098-790
Fan Filter*	For small size units (400 W, 750 W, and 800 W)	101-063-936
	For medium size units (1250 W, and 1500 W)	101-063-935
	For large size units (2500 W, and 4000 W)	101-063-934
Connector Block	Detachable connector block	200-029-1108
Top Mounting Plate	Top mounting plate for vertical units.	100-079-462
Bottom Mounting Plate	Bottom mounting plate for vertical units.	100-079-463

* When using a fan filter on DCX power supplies, the maximum output power must be derated by 10%.

7.5 Troubleshooting

If you have a problem operating the DCX HD Power Supply, take the following steps:

Table 7.13 Troubleshooting

Step	Action
1	Make sure the converter-booster-horn stack is properly assembled and installed.
2	For instructions on reconditioning stack component surfaces, refer to 7.2.2 Recondition the Stack (Converter, Booster, and Horn)
3	If you need additional help, call your local Branson representative, refer to 1.3 How to Contact Branson .

NOTICE	
	DCX HD Power Supply should be serviced only by qualified technicians using Branson-approved test and repair equipment, repair procedures, and replacement parts. Unauthorized attempts at repair or modification of the power supply will void the warranty.

7.5.1 Common Electrical Problems

NOTICE	
	If the circuit breaker fails more than once, this usually indicates that another component has failed. Continue troubleshooting other components.

Table 7.14 Troubleshooting Common Electrical Problems

Problem	Check	Solution
Main circuit breaker trips when plugging the power supply into an electrical outlet.	Inspect line connection cables.	If failed, replace.
Main circuit breaker trips during weld cycle.	Check current rating of the main circuit breaker.	If failed, replace.
Main circuit breaker fails during power up.	Check main circuit breaker current rating.	If incompatible, replace main circuit breaker.

Table 7.14 Troubleshooting Common Electrical Problems

Problem	Check	Solution
When touching a component of the weld system, you get a slight electrical shock.	Ensure the Ground cable is connected properly.	N/A
	Inspect the line cables.	If failed, repair or replace.

7.5.2 Fan/Power Switch Problems

Table 7.15 Troubleshooting Fan/Power Switch Problems

Problem	Check	Solution
Fan does not work; power indicator light is on.		Send unit for repair.
Fan does not work; Power indicator does not light when Power switch is on.	Make sure power supply is plugged into main power.	If power is available and unit fails to work, send the unit for repair.
	Test Power On/Off Switch (power supply circuit breaker).	Send unit for repair.

7.5.3 Ultrasonic Power Problems

Table 7.16 Troubleshooting Ultrasonic Power Problems

Problem	Check	Solution
Ultrasonic power delivered to horn; no indication on bar graph.	Check connector cables, replace if failed.	Replace defective cables.
	Test power supply.	See Chapter 6: Operation 6.7 Ultrasonics Test Procedure
No ultrasonic power generated when Test key pressed; no Alarm indicator.	Failed or missing stack.	Replace.
	RF cable unplugged or failed; replace if failed.	Plug in or replace.
	Test power supply (Chapter 6: Operation 6.7 Ultrasonics Test Procedure).	If defective, send unit for repair.

Table 7.16 Troubleshooting Ultrasonic Power Problems

Problem	Check	Solution
Unable to adjust amplitude using the front panel keypad.	Register setting configured to "External Amplitude Control"	Reset if required, See Chapter 6: Operation 6.4 Configuring the Power Supply Registers
Unable to remote control.	User I/O cable	Repair or replace.
	Customer's switching device	Test/inspect/repair/replace.

7.5.4 Weld Cycle Problems

Table 7.17 Troubleshooting Weld Cycle Problems

Problem	Check	Solution
Full ultrasonic power not delivered.	Unsuitable horn or booster selection.	Contact Branson Applications Lab
	Plastic part material varies.	
	Mold release lubricant in weld area.	
	Unsuitable joint design.	
	Unsuitable or misaligned part fixture.	
	Amplitude setting	Adjust if required.
No ultrasonic power passed to horn.	Power supply overheating; check fan and vents.	Replace improperly operating fan. Remove dust and debris.
Alarm indicator illuminates when you press the Test key or during the weld cycle.	Check converter-booster-horn stack interface for fretting corrosion.	See 7.2.2 Recondition the Stack (Converter, Booster, and Horn)
	Check for loose or failed horn converter or booster.	Tighten or replace as needed.
	Check for loose or failed horn or booster stud.	
	Failed RF cable	Replace if failed.
Excessively warm horn, booster, and converter; occasional overloads.	Check converter-booster-horn stack mating surfaces for fretting corrosion.	See 7.2.2 Recondition the Stack (Converter, Booster, and Horn)
	Be certain proper cooling has been provided.	Replace fan if required.

7.6 Cold Start Procedure

The power supply internal memory stores the system default settings and the registers that you set. It also provides temporary storage to support the power supply internal functions. A cold start clears the Amplitude Setting, the user I/O configuration, the IP address, and restores them to original factory defaults. It is not necessary to perform a cold start during normal operation and servicing, but you might find a cold start helpful when:

You suspect the system is not operating properly.

You want to make a new setup.

Some system memory registers, such as Software version, will not be cleared by this Cold Start procedure.

7.6.1 Performing a Cold Start

NOTICE	
	<p>Using the Cold Start procedure will erase the current Amplitude Setting, the IP address and some of the Registers that you set. Be sure you have a record of your setup if you want to retain it or use the system backup feature from the DCX Power Supply Web Page Interface.</p>

Table 7.18 Steps to Perform a Cold Start

Step	Action
1	Turn off the power supply.
2	Connect together pins 4 and 10 on the 26-pin User I/O Connector.
3	Turn on the power supply.
4	After the power up sequence ends, turn off the power supply
5	Disconnect pins 4 and 10 of the 26-pin on User I/O Connector.

Appendix A: Signal Diagrams

A.1 Signal Diagrams 102

A.1 Signal Diagrams

Figure A.1 Continuous

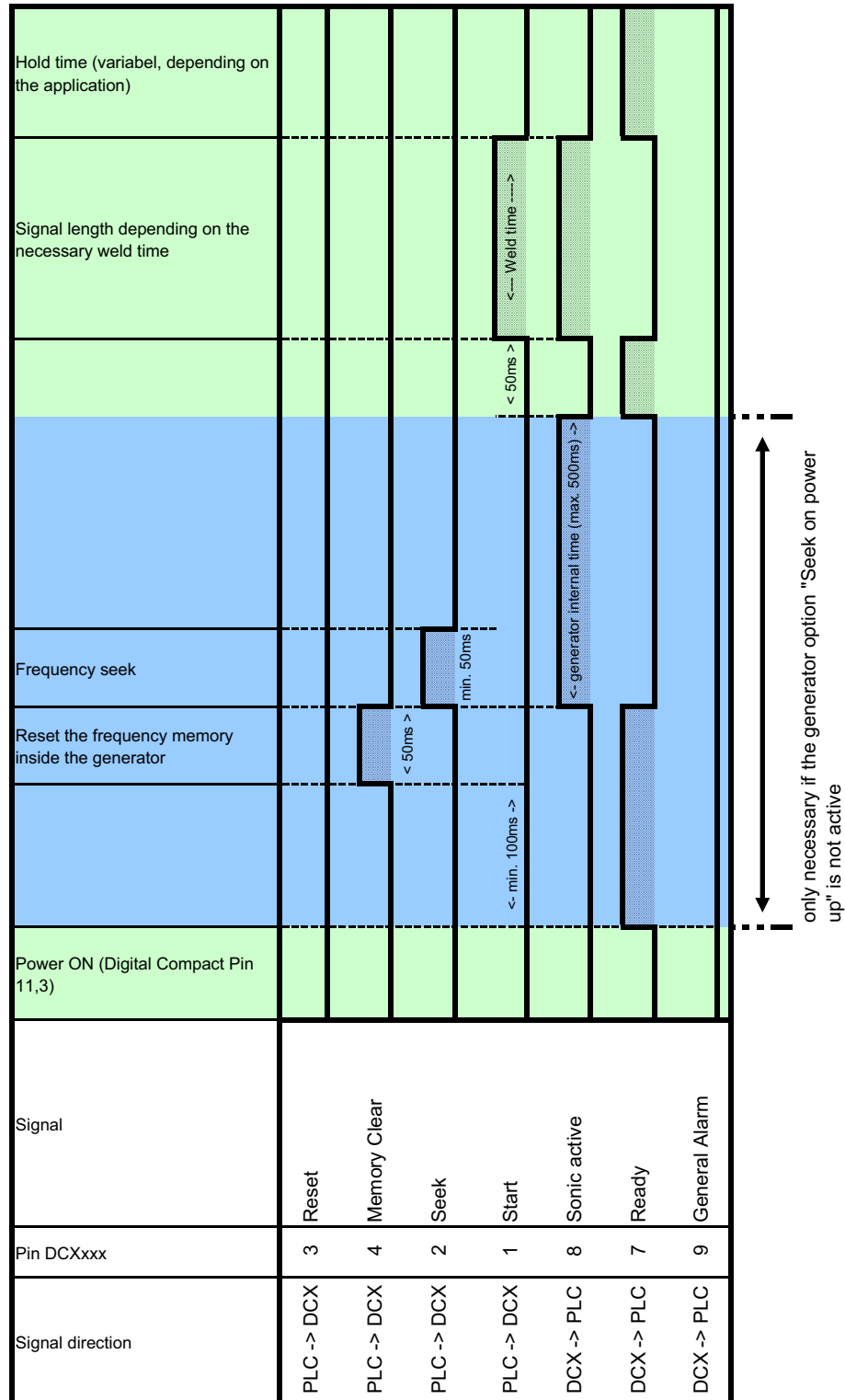
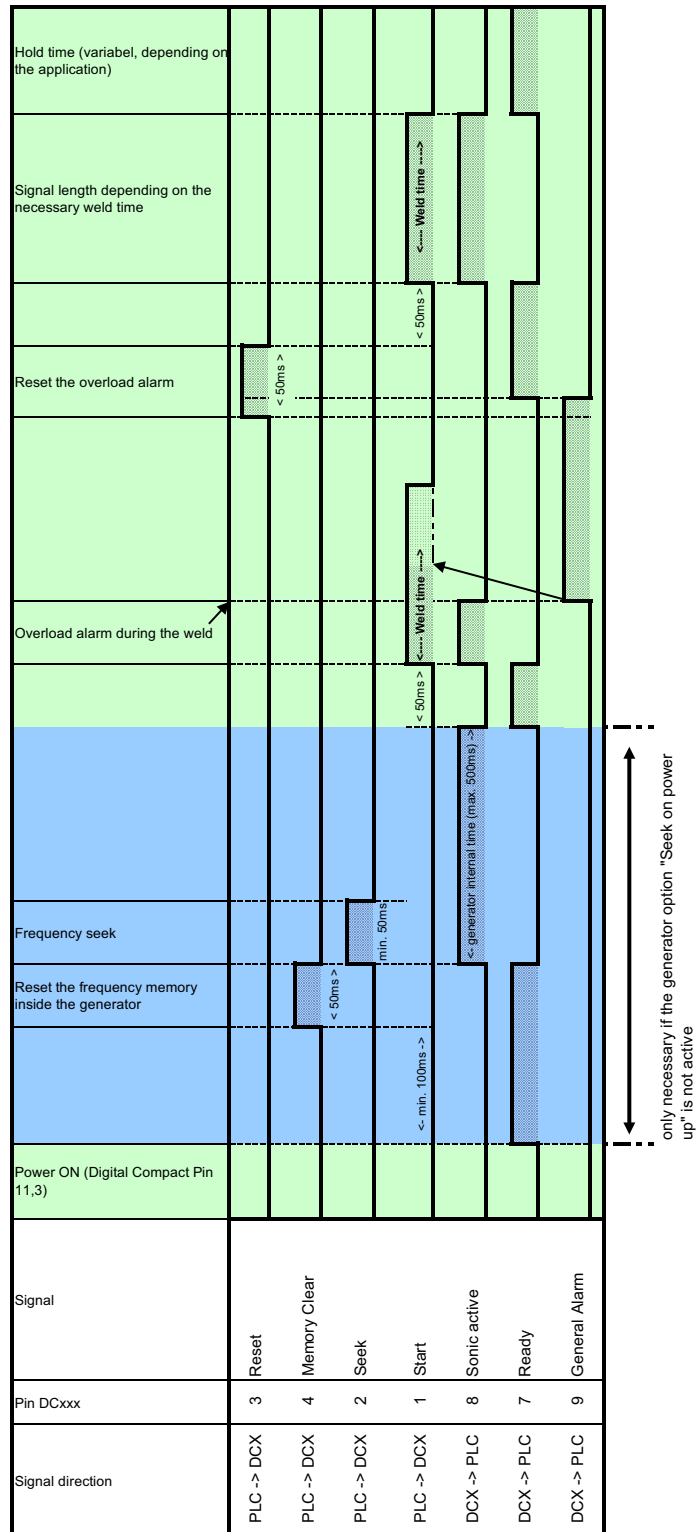

Figure A.2 Continuous, Overload Error



Index

A

- about Installation 36
- actuator 22
- alarm 22
 - configuring 54
 - latching 54
 - modes 54
- alarms
 - latching 69
- amplitude 71
 - controlling 54
 - definition 22
 - external control 22
 - start ramp 16, 54, 70
- amplitude control 54
- applications 21
- autotune with memory (AT/M) 13

B

- bar graph 19, 72
 - frequency interpretation 72
 - power interpretation 72
 - setup 69
- bend radius 43
- booster 17, 22
 - part numbers 93

C

- cables
 - bend radius 43
 - RF 51
 - user I/O 46
- clamping force 22
- cold start 100
- connecting tip to horn 58
- connection
 - input power 52
 - user I/O 46
- connector
 - line 20
 - RF 20
 - user I/O 20
- controls, front panel 18
- converter 17, 22
 - cooling 59
 - part numbers 93
- counters 22

D

- degating 22
- DHCP setting 71
- drop test 26

E

- electrical input
 - operating voltages 32
- energy director 22
- environmental
 - requirements 42
 - specifications 26
- external
 - amplitude control 22
 - frequency control 22

F

- fixture 22
- flash 22
- force 22
- forming 22
- frequency 22
 - end of weld store 54, 70
 - external control 22
 - offset 14, 22, 70
 - seek 23
- frequency offset
 - definition 16
 - setup 54

G

- gain 22
- ground screw 20

H

- horn 17, 22
 - amplitude 22
 - scan 22
 - scan, power-on 70
 - signature, definition 16
- humidity 26, 32, 42

I

- indicators 18
- input
 - connection examples 51
- input power 51, 52
 - plug 52
 - ratings 32, 42
- inputs
 - analog 49
 - digital 49
- insertion 22
- installation 35
 - requirements 37

- stack 60
- steps 43
- testing 60
- interface 22
- inventory of small parts 29
- IP address 70

J

- joint 23

L

- LCD
 - bar graph 72
 - frequency interpretation 72
 - power interpretation 72
 - setup 69
 - description 19
 - viewing angle 45
- line input
 - connector 20
- line regulation 13
- load regulation 13

M

- maintenance 83
 - general considerations 84

O

- operating voltages 32
- operation 63
 - principle of 21
- output
 - connection examples 51
- output power cable 51
- outputs
 - analog 50
 - digital 49

P

- parameter 23
- parts lists 92
- periodic and preventive maintenance
 - periodically clean the equipment 86
 - recondition the stack 86
 - routine component replacement 92
- power
 - switch 20
- power supply
 - amplitude control 22
 - configuring 68
 - connections 20
 - continuous duty max. power 33
 - cycle rate 34
 - default settings (cold start) 100
 - front panel controls 18

- manual set 12
- models 12
- mounting 43
- power-on actions 70

R

- receiving the equipment 27
- restoring defaults 70
- returning equipment 30

S

- safety
 - general precautions 4
 - maintenance 84
 - symbols, meaning 2
- seek 23
 - definition 16
 - power-on 70
 - ramp time 54
 - time 54, 70
 - timed 13, 54
- shipping and handling 26
- shock 26
- special cable requirements 43
- stack 17
- stack assembly 55
 - 20 kHz 57, 89, 90
 - 30 kHz 57
 - 40 kHz 58
- staking 23
- support 61
- swaging 23
- system requirements, web page interface 75

T

- technical specifications 31
- temperature
 - ambient operating temperature 32, 42
 - shipping and storage 26, 32
- test, ultrasonic 18
- thermoplastic 23
- thermoset 23
- timed seek 13
- troubleshooting
 - electrical problems 96
 - fan/power switch problems 97
 - ultrasonic power 97
 - weld cycle problems 99

U

- ultrasonic power 23
- ultrasonic welding 23
- unpacking 28

V

vibration 26

W

web page interface 14, 16, 75

point-to-point connection

Windows Vista and Windows 7 75

Windows XP 77

weld system 23

applications 21

welding systems 21

