

Assembly and operating instructions

Stroke modules

HM 10 | HM 16 | HM 25



Translation of the Original Assembly Instructions EN

- HM 10/10 ⇒ Order no.: 50287740
- HM 10/25 ⇒ Order no.: 50287741
- HM 16/16 ⇒ Order no.: 50287742
- HM 16/40 ⇒ Order no.: 50287743
- HM 25/25 ⇒ Order no.: 50287744
- HM 25/64 ⇒ Order no.: 50287745

Dear Customer

Thank you for choosing our products and placing your trust and confidence in our company!

These assembly and operating instructions contain all essential information you need about your product. Our aim is to provide the required information as concisely and clearly as possible. If, however, you still have any questions on the contents or suggestions, please do not hesitate to contact us. We are always grateful for any feedback.

Our team will also be glad to answer any further question you may have regarding the stroke module or other options.

We wish you every success with our products!

With kind regards

Your Afag team

© Subject to modifications

The modules have been designed by Afag Automation AG according to the state of the art. Due to the constant technical development and improvement of our products, we reserve the right to make technical changes at any time.

Updates of our documentations



Unlike the printed documents, our digital instructions manuals, product data sheets and catalogues are being continuously updated on our website.

Please keep in mind that the digital documents on our website are always the latest versions.

© Copyright 2023 Afag Automation AG

All contents of the present assembly and operating instructions, in particular the texts, photographs and graphics, are protected by copyright. All rights reserved. No part of these assembly and operating instructions may be reproduced, distributed (made available to third parties), or transmitted in any form or by any means, including photocopying, recording, or other electronic or mechanical methods, without the prior written permission of Afag Automation AG.

Afag Automation AG
Luzernstrasse 32
CH-6144 Zell (Switzerland)
Tel.: +41 62 959 86 86
e-mail: sales@afag.com
Internet: www.afag.com

Table of contents

1	General	6
1.1	Contents and purpose of these assembly instructions.....	6
1.2	Explanation of symbols.....	6
1.3	Additional symbols.....	7
1.4	Applicable documents	8
1.5	Warranty	8
1.6	Liability.....	8
2	Safety instructions	9
2.1	General.....	9
2.2	Intended use.....	9
2.3	Foreseeable misuse	9
2.4	Obligations of the operator and the personnel	10
2.4.1	Observe the assembly instructions	10
2.4.2	Obligations of the operating company.....	10
2.4.3	Obligations of the personnel	11
2.5	Personnel requirements	11
2.5.1	Personnel qualification	11
2.6	Personal protective equipment (PPE)	12
2.7	Changes & Modifications.....	12
2.8	General hazards / residual risks.....	13
2.8.1	General hazards at the workplace	13
2.8.2	Mechanical hazards	13
2.8.3	Danger due to electricity	14
2.8.4	Danger due to pneumatics	14
3	Technical data	15
3.1	Stroke module HM 10.....	15
3.1.1	Dimensional drawing HM 10	15
3.1.2	Technical data HM 10	16
3.1.3	Preferred combinations HM 10	17
3.1.4	Module loads HM 10	18
3.1.5	Diagrams stroke range HM 10/10 and HM 10/25	19
3.2	Stroke module HM 16.....	21
3.2.1	Dimensional drawing HM 16	21
3.2.2	Technical data HM 16	22
3.2.3	Preferred combinations HM 16	23
3.2.4	Module loads HM 16	24
3.2.5	Diagrams stroke range HM 16/16 and HM 16/40	25
3.3	Stroke module HM 25.....	27
3.3.1	Dimensional drawing HM 25	27
3.3.2	Technical data HM 25	28
3.3.3	Preferred combinations HM 25	29

3.3.4	Module loads HM 25	30
3.3.5	Diagrams stroke range HM 25/25 and HM 25/64	31
4	Transport, packaging and storage	33
4.1	Safety instructions for transport.....	33
4.2	Scope of supply	34
4.3	Transport	34
4.4	Packaging.....	35
4.5	Storage	35
5	Design and description	36
5.1	Structure of lifting module.....	36
5.2	Product description.....	36
5.3	Accessories	37
6	Installation, assembly & setting	38
6.1	Safety Instructions for Installation & Assembly	38
6.2	Assembly and attachment	39
6.2.1	Attachment options.....	39
6.2.2	Tightening torques.....	40
6.3	Pneumatic connections	40
6.4	Installation of the initiator.....	41
7	Commissioning	42
7.1	Safety instructions for commissioning	42
7.2	Preparatory activities for commissioning.....	43
7.2.1	Adjustment of the shock absorber.....	43
7.2.2	Setting the stroke (under pressure).....	44
7.3	Commissioning of the modules	45
8	Fault elimination.....	46
8.1	Safety instructions for troubleshooting	46
8.2	Fault causes and remedy	46
9	Maintenance and repair	47
9.1	General notes	47
9.2	Safety instructions for Maintenance and Repair	47
9.3	Maintenance activities and maintenance intervals.....	48
9.3.1	Overview of the maintenance points	48
9.3.2	Further maintenance	48
9.3.3	Compressed air specification	48
9.4	spare and wear parts lists,	50
9.4.1	General notes.....	50
9.4.2	Safety instructions	50
9.4.1	Spare parts.....	50
9.5	Repair and overhaul	51
9.5.1	Dismantling the extension shock absorbers	51

9.5.2	Replacing the retractable shock absorber	51
9.5.3	Remove load compensation of the lifting module	52
9.5.4	Remove the pressure spring of the load compensation	52
10	Decommissioning, disassembly, disposal.....	53
10.1	Safety instructions	53
10.2	Decommissioning	53
10.3	Disposal	53
11	Declaration of incorporation	54

1 General

1.1 Contents and purpose of these assembly instructions

These assembly instructions contain important information on assembly, commissioning, functioning and maintenance of the HM 10, HM 16 and HM 25 to ensure safe and efficient handling and operation.

Consistent compliance with these assembly instructions will ensure:

- permanent operational reliability of the stroke modules,
- optimal functioning of the stroke modules,
- timely detection and elimination of defects (thereby reducing maintenance and repair costs),
- Prolonging of the stroke modules service life.

The illustrations in this manual shall provide you with a basic understanding of the module and may vary from the actual design of your module.

1.2 Explanation of symbols

The safety notes are marked by a pictogram and a signal word. The safety notes describe the extent of the hazard.

DANGER



Danger!

This safety note indicates an imminently hazardous situation which, if not avoided, will result in death or serious injury.

WARNING



Warning!

This safety note points out a potentially hazardous situation which, if not avoided, could result in death or serious injury.

CAUTION



Caution!

This safety note points out a potentially dangerous situation which, if not avoided, can result in minor or slight injuries.

NOTICE

This safety note points out a potentially dangerous situation which, if not avoided, can cause substantial damage to property and the environment.



This note contains important additional information as well as useful tips for safe, efficient and trouble-free operation of the stroke modules.

Further warning signs:

Where applicable, the following standardised symbols are used in this manual to point out the various potential health risks.

	Warning - Dangerous electrical voltage.
	Warning - Risk of injury from contact with hot surfaces.
	Warning - Risk of hand and finger injury due to uncontrolled movements of components.
	Warning - Magnetic field
	Warning - Risk of injury as a result of parts being flung out!
	Warning -high noise levels

1.3 Additional symbols

In these assembly instructions the following symbols are used to highlight instructions, results, references, etc..

Symbol	Description
1.	Instructions (steps ...)
⇨	Results of actions
↻	References to sections
■	Enumerations not ordered

1.4 Applicable documents



Each module is accompanied by a safety information sheet. This information sheet must be read carefully by every person who carries out work on and with the module.

1.5 Warranty

The warranty terms for Afag handling components and handling systems are the following:

- 24 months from initial operation and up to a maximum of 27 months from delivery.
- Wear parts are excluded from the warranty (The customer is entitled to a product free of defects. *This does also apply to defective accessories and wear parts. Normal wear and tear are excluded from the warranty.*)

The warranty covers the replacement or repair of defective Afag parts. Further claims are excluded.

The warranty shall expire in the following cases:

- Improper use of the module.
- Non-observance of the instructions regarding assembly, commissioning, operation and maintenance of the module.
- Improper assembly, commissioning, operation and maintenance.
- Repairs and design changes carried out without prior technical instructions of Afag Automation AG.
- Removing the serial number from the product.
- Inadequate checking of wear parts.
- Non-observance of the EC Machinery Directive, the Accident Prevention Regulations, the Standards of the German Electrotechnology Association (VDE) and these safety and assembly instructions.

1.6 Liability

No changes shall be made to the stroke module unless described in this instructions manual or approved in writing by Afag Automation AG.

Afag Automation AG accepts no liability for unauthorized changes or improper assembly, installation, commissioning, operation, maintenance or repair work.

2 Safety instructions

2.1 General

This chapter provides an overview of all important safety aspects to ensure safe and proper use of the gripper and optimal protection of personnel. Safe handling and trouble-free operation of the stroke module requires knowledge of the basic safety regulations.

Every person carrying out installation, commissioning, maintenance work or operating the telescope spindle axis must have read and understood the complete user manual, especially the chapter on safety instructions.

Beyond this, there are rules and regulations regarding accident prevention that are applicable to the place of installation which must be observed.

Improper use may result in danger to life and limb of the user or third parties or in damage to the automation system or other material assets.



Failure to follow the directions and safety instructions given in this instructions manual may result in serious hazards.

2.2 Intended use

The HM 10/16/25 series of stroke modules is used for linear movement of fixed mounted loads in **non-hazardous** environments in the ambient/application conditions defined for these modules (→chap. 3 "Technical data").

The modules are intended exclusively for lifting payloads that do not react in a way that is hazardous to persons, property or the environment when manipulated. (→chap. 3 "Technical data").

The stroke modules HM 10/16/25 modules can be used in combination with other modules as a pick converted place station, whereby the permissible load capacity must not be exceeded.

Any use beyond the described purpose is considered to be not in accordance with the intended use.



The intended use of the module also includes:

- observance of all instructions given in this instructions manual.
 - compliance with the inspection and maintenance work and the specifications in the data sheets,
 - using only original spare parts.
-

2.3 Foreseeable misuse

Any use other than or beyond the intended use described is considered a misuse of the stroke modules.

Especially the following use is considered a misuse:

- Use in potentially explosive atmospheres

WARNING
Risk of injury if the module is not used as intended!

The improper use of the stroke modules poses a potential hazard to the personnel.



- The stroke modules may only be used in a technically perfect condition in accordance with its intended use and the instructions in this manual as well as in compliance with the safety requirements!
- Any malfunctions, particularly those that could impair safety, must be eliminated immediately!



Risks can occur if the module is not used as intended. In the event of damages caused by improper use the following shall apply:

- the operating company shall be solely responsible for such damage, and
- Afag does not accept any liability for damage caused by improper use.

2.4 Obligations of the operator and the personnel

2.4.1 Observe the assembly instructions

A basic prerequisite for safe and proper handling of the stroke module is a good knowledge of the basic safety instructions.



These assembly instructions, in particular the safety instructions contained therein, must be observed by all persons working with the modules.

2.4.2 Obligations of the operating company

In addition to the safety instructions given in this manual, the operating company must comply with the safety, accident prevention and environmental protection regulations valid for the field of application of the stroke module.

The operating company is required to use only personnel who :

- have the necessary professional qualifications and experience,
- are familiar with the basic rules regarding occupational safety and accident prevention,
- have been instructed in the correct handling of the stroke modules,
- have read and understood these assembly instructions.

The operating company is also required to:

- monitor on an ongoing basis that the personnel work safely considering any potential hazard involved and the assembly instructions are observed,
- ensure that the assembly instructions are always kept at hand at the installation in which the modules are mounted,
- observe and communicate universally applicable laws and regulations regarding accident prevention and environmental protection,
- provide the necessary personal protective equipment (e.g. protective gloves) and instruct the personnel to wear it.

2.4.3 Obligations of the personnel

All personnel working with the are required to:

- read and observe these assembly instructions, especially the chapter on safety,
- observe the occupational safety and accident prevention regulations,
- observe all safety and warning signs on the telescope spindle axis,
- refrain from any activity that might compromise safety and health.



In addition, the personnel must wear the personal protective equipment required for carrying out their work (➔chap. 2.6).

2.5 Personnel requirements

2.5.1 Personnel qualification

The activities described in the assembly instructions require specific requisites at the level of professional qualifications of the personnel.

Personnel not having the required qualification will not be able to assess the risks that may arise from the use of the module thus exposing himself and others to the risk of serious injury. Therefore, only qualified personnel may be permitted to carry out the described activities on the stroke module. Persons whose ability to react is restricted due to the intake of medication or the like must not interact with the stroke module.

These installation instructions are intended for skilled personnel (installers, system integrators, maintenance personnel, technicians), electricians and operating personnel.

The following is a description of the professional skills (qualifications) required for carrying out the different activities:

Qualified personnel:

Qualified personnel with appropriate training who are qualified due to their special know-how and fully familiar with the machine and who have been given instructions on how to carry out the task entrusted to them safely.

Operator (trained personnel):

Authorized persons who due to their specialized professional training, expertise and experience can identify risks and preventing possible hazards arising from the use of the machine.





2.6 Personal protective equipment (PPE)

The personal protective equipment serves to protect the personnel from hazards affecting their safety and health at work.

When working on/with the module, the personnel must wear the personal protective equipment assigned by the safety officer of the operating company or as required by safety regulations. In addition, the personnel are required to:

- wear the personal protective equipment provided by the operating company (employer),
- check the personal protective equipment for proper condition, and
- immediately notify the person responsible on site of any defects found on the personal protective equipment.

Personal protective equipment and the respective mandatory signs:

	<p><i>Protective clothing</i> is a close-fitting clothing specifically designed to protect personnel from hazards during work.</p>
	<p><i>Protective gloves</i> are specifically designed to protect the personnel against hand injuries (such as cuts, abrasion, burns).</p>
	<p><i>Safety shoes</i> are specifically designed to protect the personnel against foot injuries from crushing, falling objects or slipping on slippery surfaces.</p>
	<p>Hearing protectors are required to protect the personnel against excessive noise levels to prevent noise-induced hearing loss.</p>

2.7 Changes & Modifications

No changes may be made to the module which have not been described in these assembly instructions or approved in writing by Afag Automation AG.

Afag Automation AG accepts no liability for unauthorised changes or improper assembly, installation, commissioning, maintenance or repair work.



The stroke module may not be changed or modified in any way, except with the prior written consent of Afag Automation AG.

2.8 General hazards / residual risks

Despite the safe design of the machine and the technical protective measures taken, there still remain residual risks that cannot be avoided, and which present a non-obvious residual risk when operating the modules.

Observe the safety instructions in this chapter and in the other sections of this manual to avoid damage to property and dangerous situations for the personnel.

2.8.1 General hazards at the workplace

The modules has been built according to the state-of-the-art and the applicable health and safety requirements. However, improper use of the module may cause the following hazards to the personnel:

- danger to life and limb of the operator or third parties,
- on the stroke modules themselves,
- property damage.



Always keep the assembly instructions ready at hand at the workplace! Please, also observe:

- the general and local regulations on accident prevention and environmental protection,
 - the safety information sheet for the stroke modules.
-

WARNING



Danger - Do not use in unsuitable environment !

The stroke modules are designed for the application and environmental conditions defined in chapter 3 Technical data.

- **Only** use the stroke under the defined operating and ambient conditions!
-

2.8.2 Mechanical hazards

CAUTION



Risk of injuries by moving parts and unexpected movements!

When operating the telescope spindle axis uncontrolled movements may occur which can cause personal injury or property damage. There is always a risk of injury by moving parts during normal operation.

- Only qualified personnel may work with or on the module.
 - Never reach into the system during normal operation!
-

2.8.3 Danger due to electricity



DANGER

Danger! Risk of electric shock!

If work on electrical components is required, ensure that the work is carried out properly, failure to do so will cause serious or fatal injuries.

- Work on the machine's electrical equipment may only be performed by skilled electrician or trained personnel under the supervision of a skilled electrician in accordance with all relevant electrical regulations.
-

2.8.4 Danger due to pneumatics



WARNING

Risks by the pneumatic system!

If work on electrical components is required, ensure that the work is carried out properly, failure to do so will cause serious or fatal injuries.

- Work on the machine's electrical equipment may only be performed by skilled electrician or trained personnel under the supervision of a skilled electrician in accordance with all relevant electrical regulations.
-

3 Technical data

3.1 Stroke module HM 10

3.1.1 Dimensional drawing HM 10

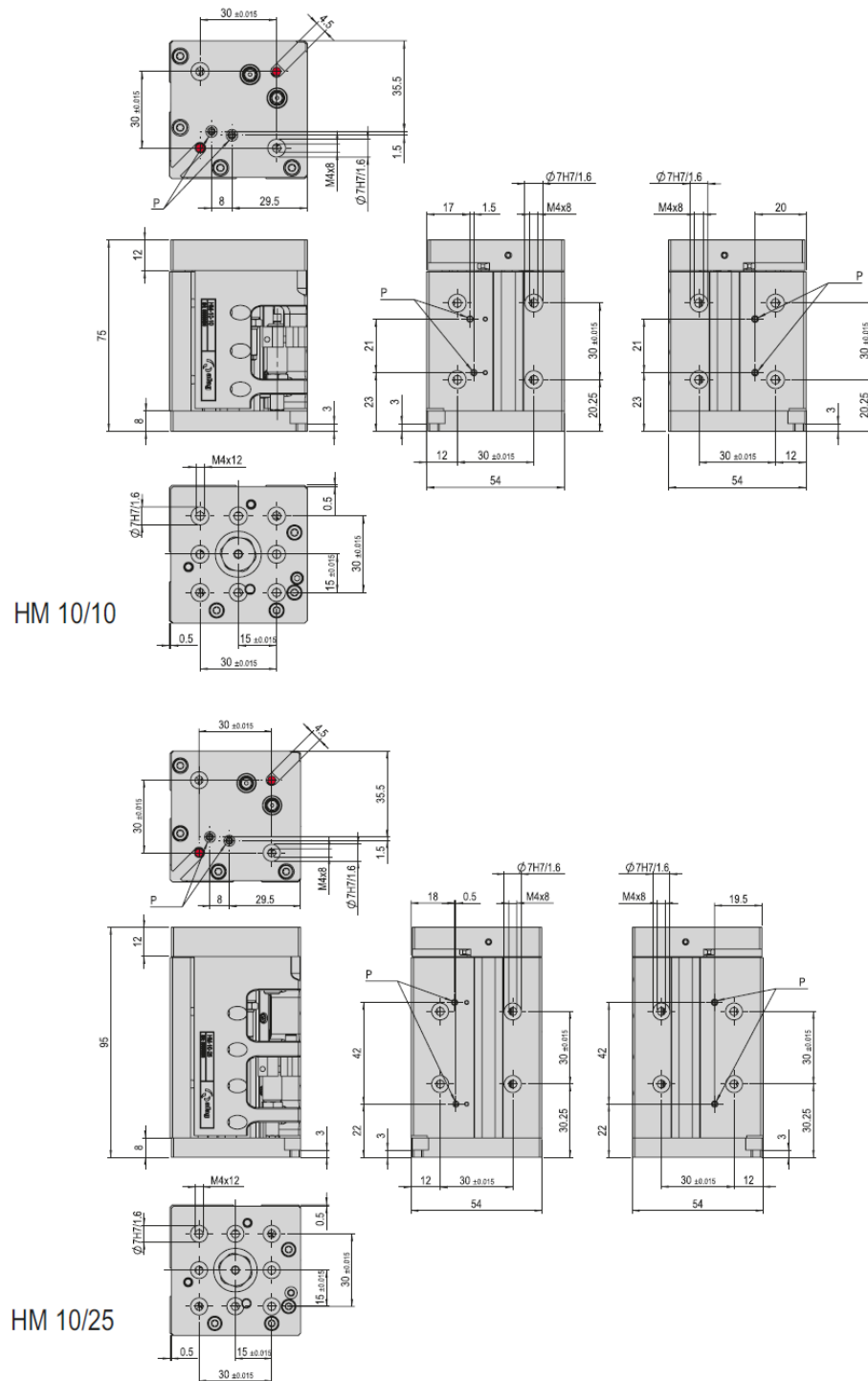

Bohrungen sind durchschraubbar

Fig. 1 Dimensional drawing - Stroke module HM 10

3.1.2 Technical data HM 10

HM 10	
Attachment grid	30 x 30 mm
Attachment thread	M4
Operating pressure	6 +/- 2 bar
Air connection P	M3
Cylinder Ø	10 mm
Retract piston force	35 N
Extend piston force	47 N
Operating temperature	0 - 50 °C
Storage temperature	0 - 50 °C
Humidity	< 90 %
Medium filtered compressed air	10 - 40 µm

Type	HM 10/10	HM 10/25
Order number	50287740	50287741
Stroke H	10 mm	25 mm
Net weight	0.519 kg	0.638 kg
Max. payload	1.2 kg	0.9 kg
Air consumption/cycle	0.007 NL	0.016 NL
Noise level	< 65 dB (A)	< 65 dB (A)
Repeat accuracy	+/- 0.01 mm	+/- 0.01 mm
Load balance (LA)	10 N	8.8 N
Mounting position	✦	✦

The technical data refer to a nominal pressure of 6 bar under Afag standard test conditions.
 Note: The load balance supports the extension stroke and damps the retraction stroke.
 The module can be operated with lubricated or dry air.
 Cleanroom class ISO 14644-1, class ISO 7

Included in the delivery
 (Catalogue HT accessories)

- 2x Centering bushing Ø7x3
- 2x Mounting screw M4x8
- 2x Mounting screw M4x12
- 2x Washer M4
- 2x Shock absorber SD M6x0.5 -3
- 2x Stop sleeve ASH M8x1 -1

Accessories

(Catalogue HT accessories)

- Compressed air connection angled M3 x 0.5
- Compressed air connection straight M3 x 0.5
- INI c10x19.5-Em-PNP-NO-M8x1

Alternative accessories

(Catalogue HT accessories)

- INI c10x28.5-Em-PNP-NO-M8x1

Fig. 2 Technical data stroke module HM 10

3.1.3 Preferred combinations HM 10

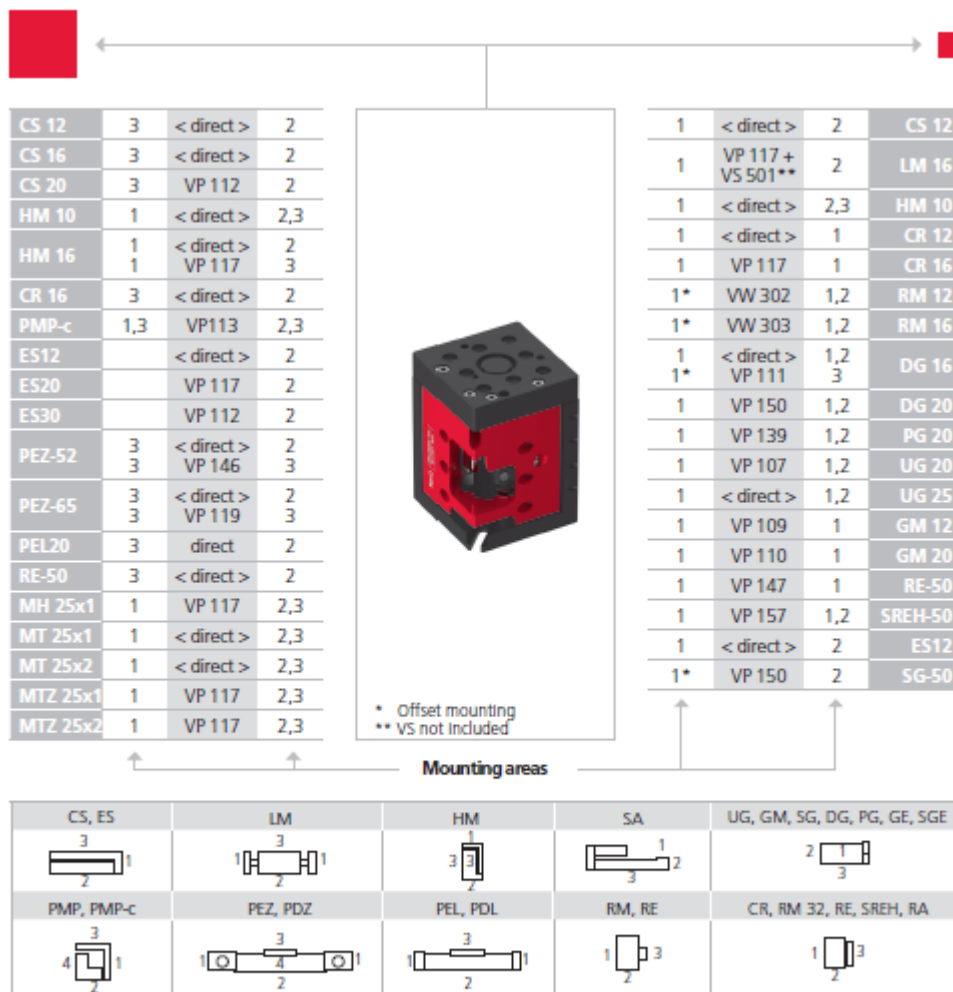

Note that there might be different mounting positions from one module to another one.
The required connection elements and the range of support columns are depicted in the catalogue HT accessories.

3.1.4 Module loads HM 10

Type	HM 10/10	HM 10/25
Max. static torque M_x	11 Nm	14 Nm
Max. static torque M_y	7 Nm	7 Nm
Max. static torque M_z	7 Nm	7 Nm
Max. effective force F_y	180 N	150 N
Max. effective force F_z	180 N	150 N
Effective distance W_x	38 mm	45 mm

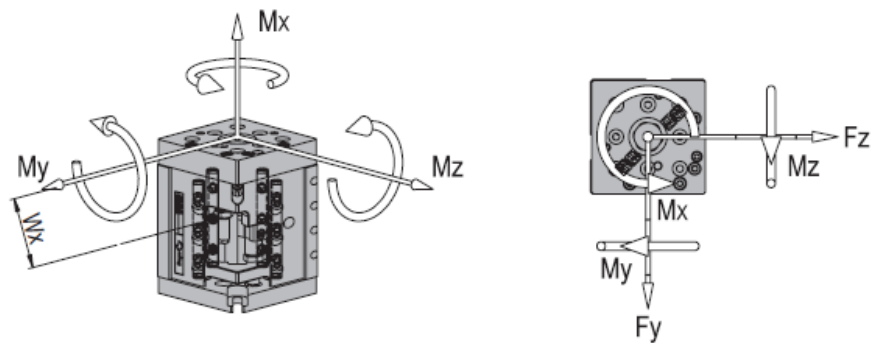
Operation time diagrams

Stroke times HM 10/10 extend vertically

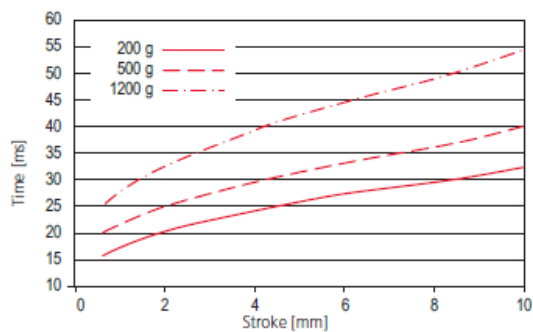

Stroke times HM 10/25 extend vertically

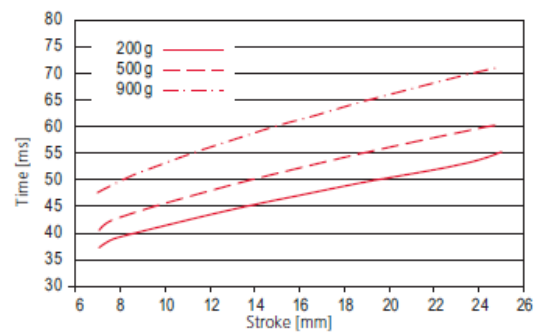

3.1.5 Diagrams stroke range HM 10/10 and HM 10/25

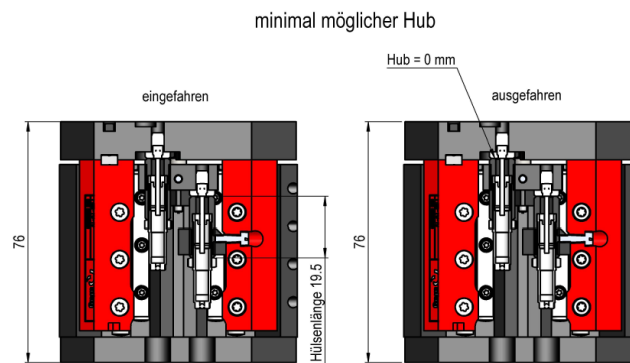

Hub bei kleinster Bauhöhe

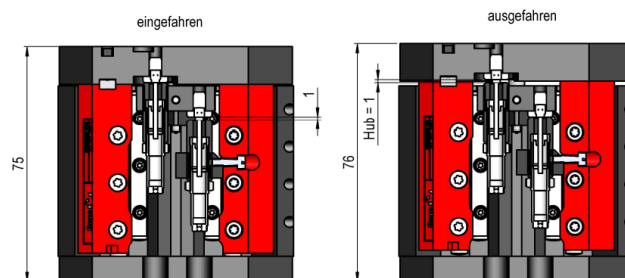

maximal möglicher Hub

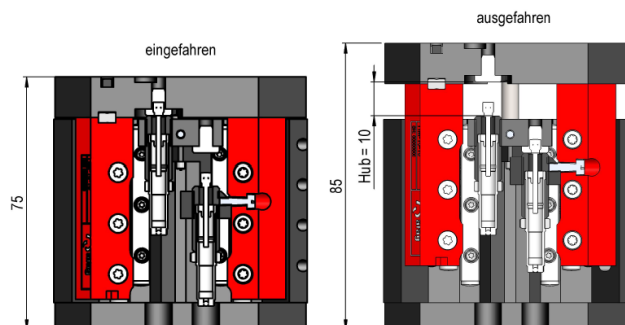

Hubbereich HM 10/10

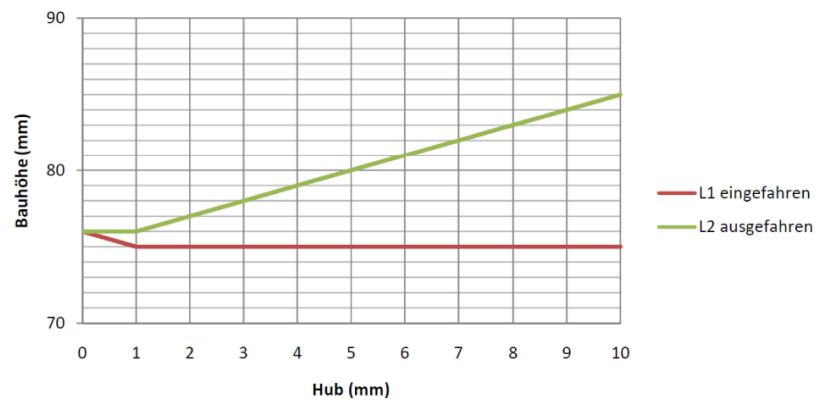

minimal möglicher Hub

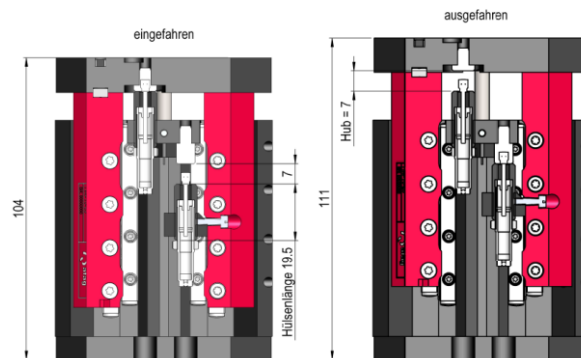

Hub bei kleinster Bauhöhe

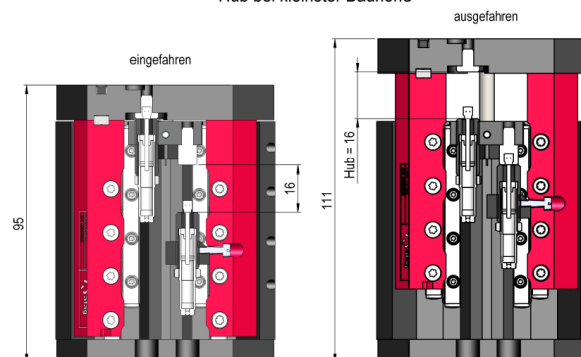

maximal möglicher Hub

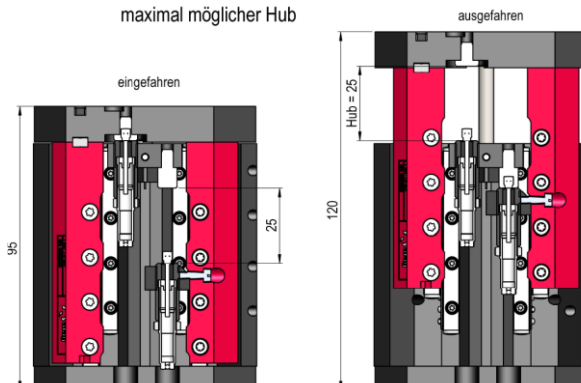

Hubbereich HM 10/25

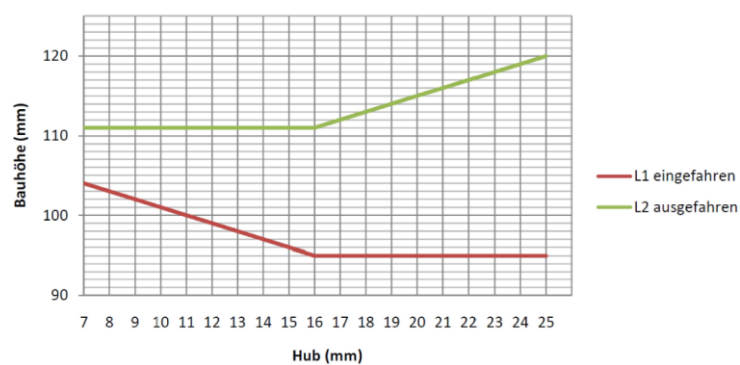

3.2 Stroke module HM 16

3.2.1 Dimensional drawing HM 16

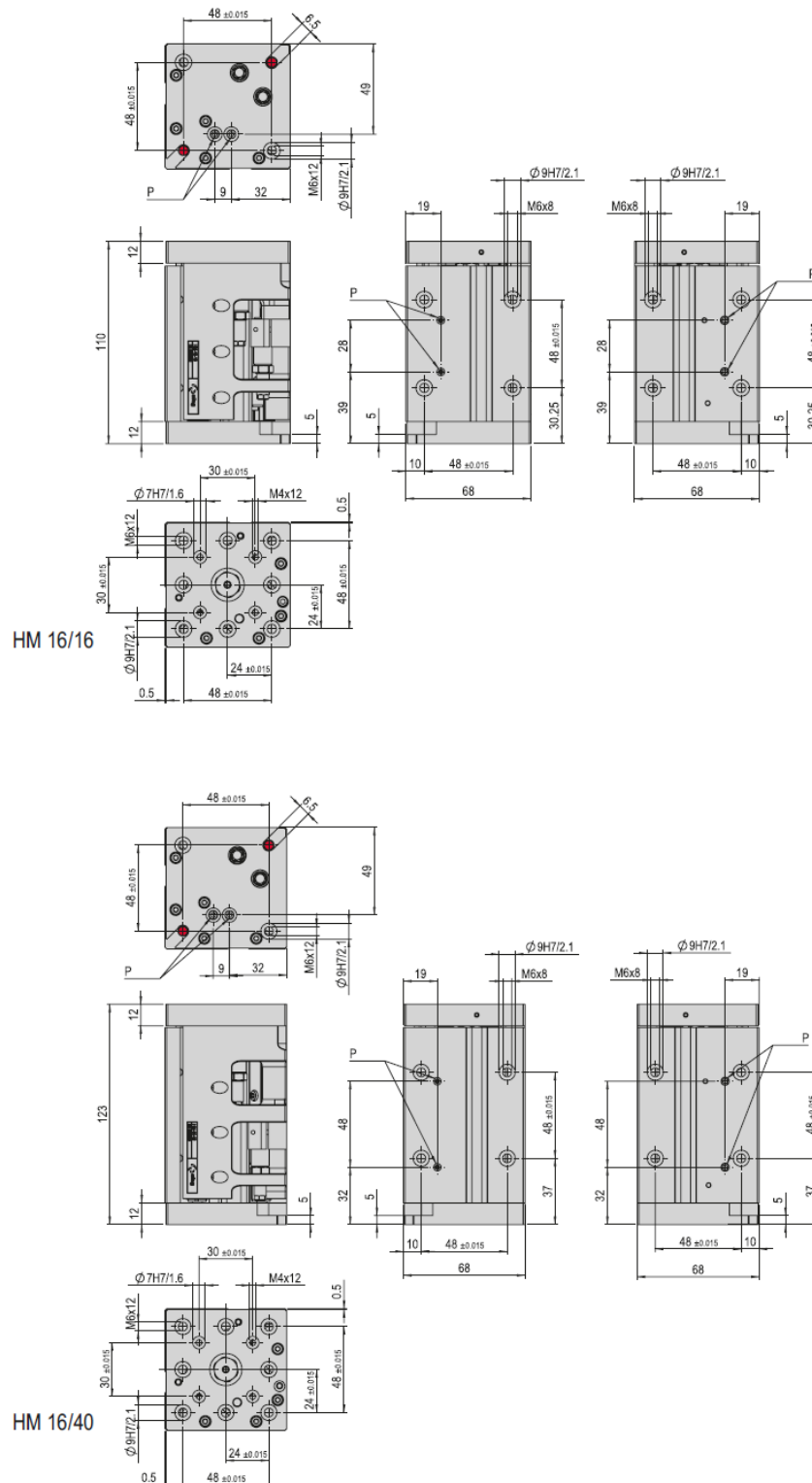

Bohrungen sind durchschraubbar

Fig. 3 Dimensional drawing - HM 16

3.2.2 Technical data HM 16

HM 16		
Attachment grid	30 x 30 mm	
Attachment grid alternative	48 x 48 mm	
Attachment thread	M4	
Attachment thread alternative	M6	
Operating pressure	6 +/- 2 bar	
Air connection P	M5	
Cylinder Ø	16 mm	
Retract piston force	103 N	
Extend piston force	120 N	
Operating temperature	0 - 50 °C	
Storage temperature	0 - 50 °C	
Humidity	< 90 %	
Medium filtered compressed air	10 - 40 µm	

Type	HM 16/16	HM 16/40
Order number	50287742	50287743
Stroke H	16 mm	40 mm
Net weight	1.208 kg	1.321 kg
Max. payload	4 kg	3 kg
Air consumption/cycle	0.028 NL	0.069 NL
Noise level	< 65 dB (A)	< 65 dB (A)
Repeat accuracy	+/- 0.01 mm	+/- 0.01 mm
Load balance (LA)	30 N	25 N
Mounting position	✚	✚

The technical data refer to a nominal pressure of 6 bar under Afag standard test conditions.
 Note: The load balance supports the extension stroke and damps the retraction stroke.
 The module can be operated with lubricated or dry air.
 Cleanroom class ISO 14644-1, class ISO 7

Included in the delivery
 (Catalogue HT accessories)

- 2x Centering bushing Ø9x4
- 2x Mounting screw M6x16
- 2x Washer M6
- 2x Stop sleeve ASH M10x1 -2
- 2x Shock absorber SD M8x1 -5

Accessories

(Catalogue HT accessories)

- INI c10x19.5-Em-PNP-NO-M8x1
- INI c10x28.5-Em-PNP-NO-M8x1

Fig. 4 Technical data HM 16

3.2.3 Preferred combinations HM 16

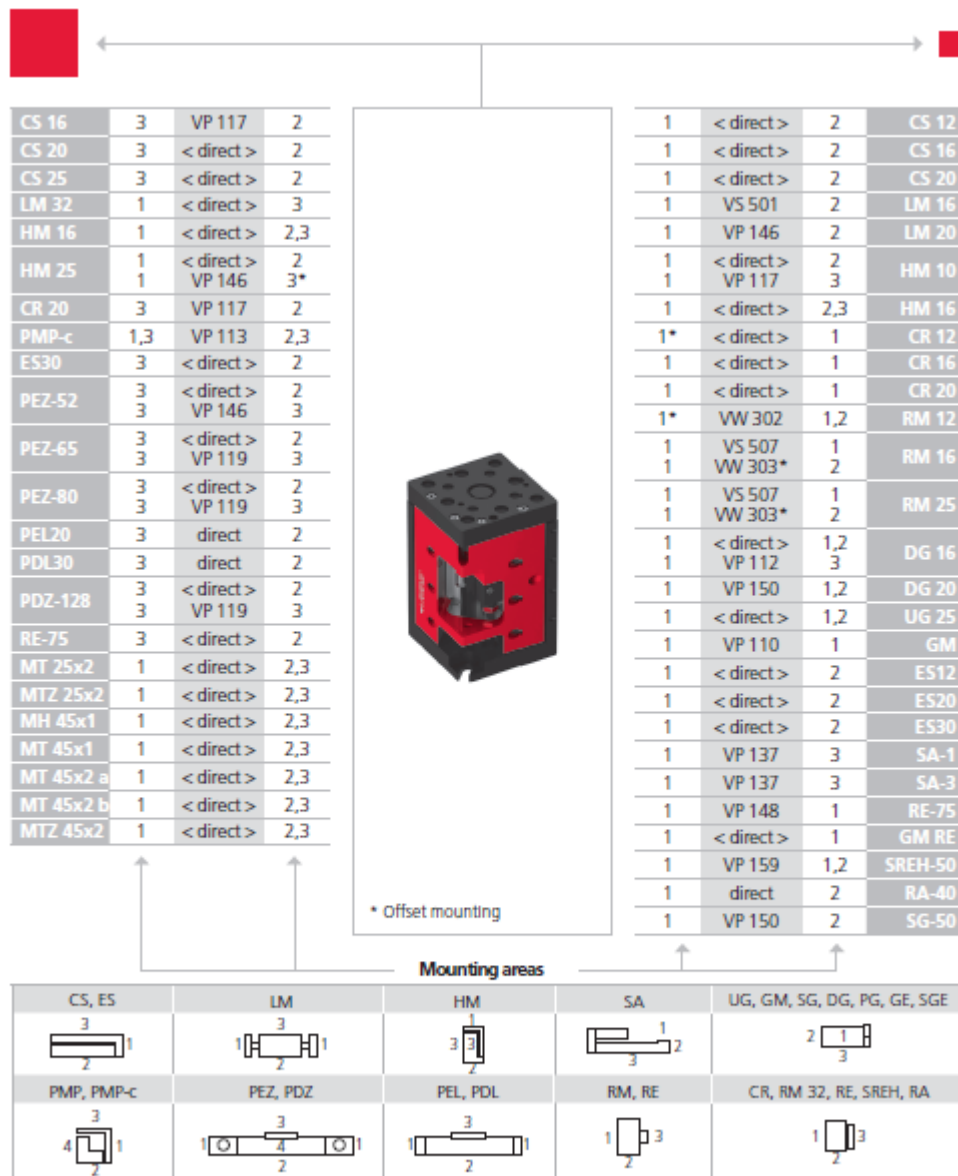

Note that there might be different mounting positions from one module to another one.
 The required connection elements and the range of support columns are depicted in the catalogue HT accessories.

3.2.4 Module loads HM 16

Type	HM 16/16	HM 16/40
Max. static torque M_x	30 Nm	30 Nm
Max. static torque M_y	20 Nm	22 Nm
Max. static torque M_z	20 Nm	22 Nm
Max. effective force F_y	380 N	420 N
Max. effective force F_z	380 N	420 N
Effective distance W_x	51.5 mm	51 mm

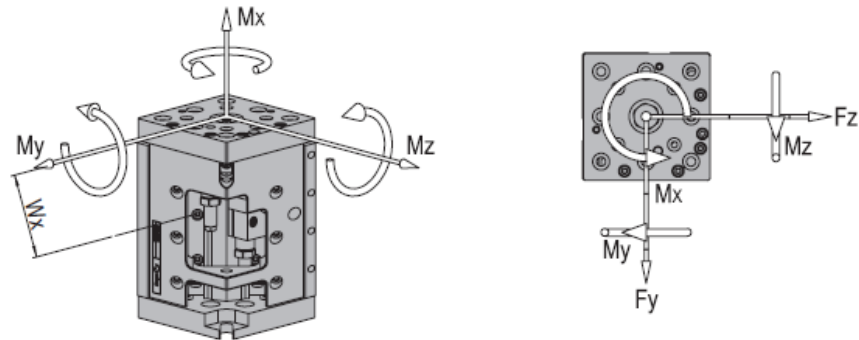
Operation time diagrams

Stroke times HM 16/16 extend vertically

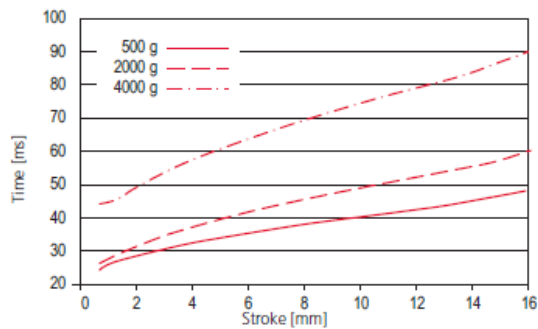

Stroke times HM 16/40 extend vertically

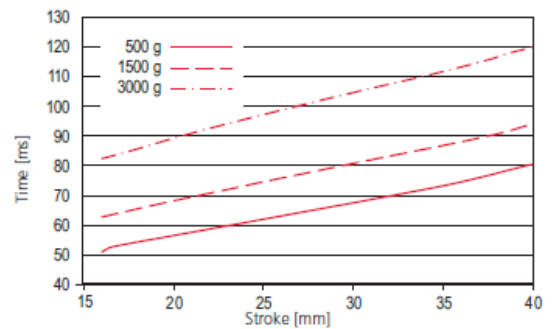

3.2.5 Diagrams stroke range HM 16/16 and HM 16/40

minimal möglicher Hub

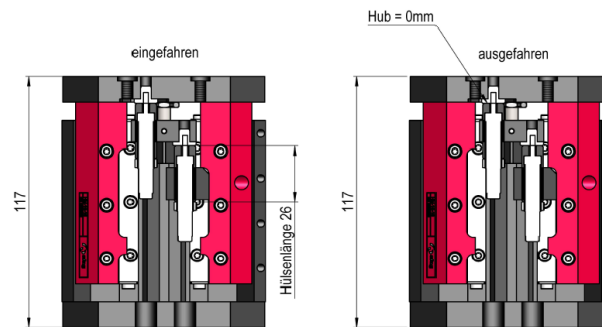

Hub bei kleinster Bauhöhe

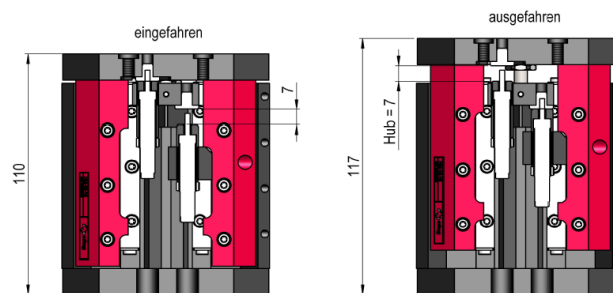

maximal möglicher Hub

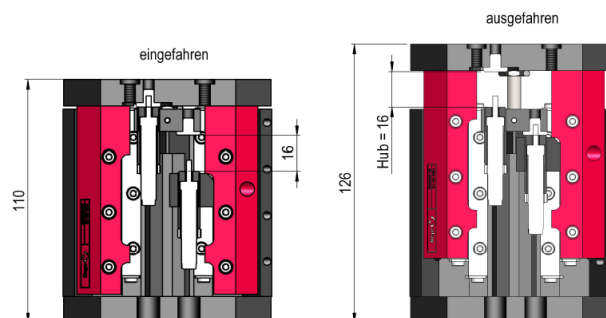

Hubbereich HM 16/16

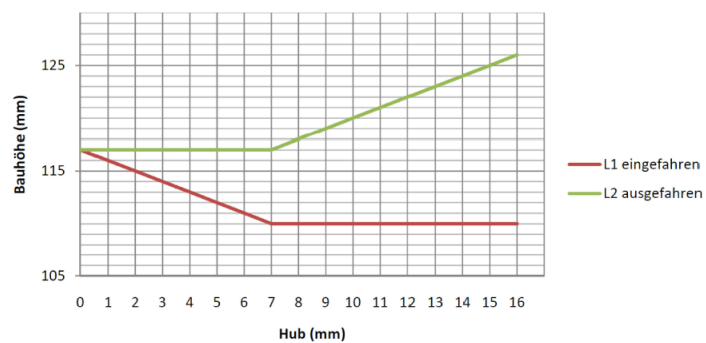

minimal möglicher Hub

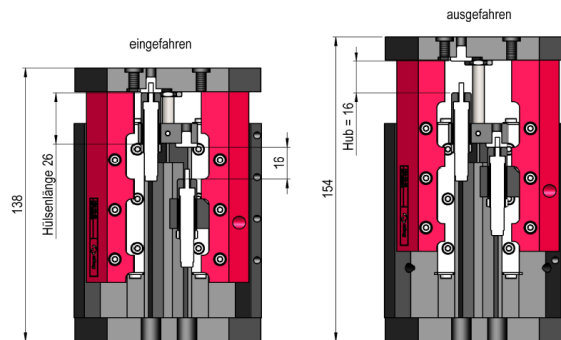

Hub bei kleinster Bauhöhe

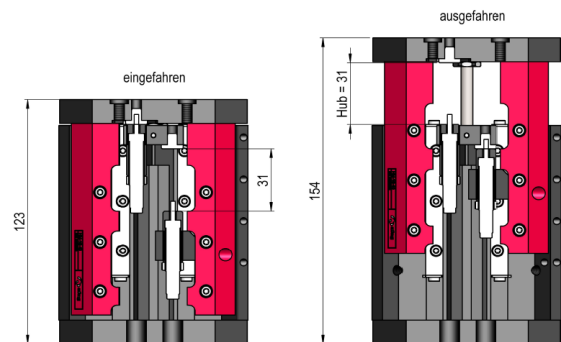

maximal möglicher Hub

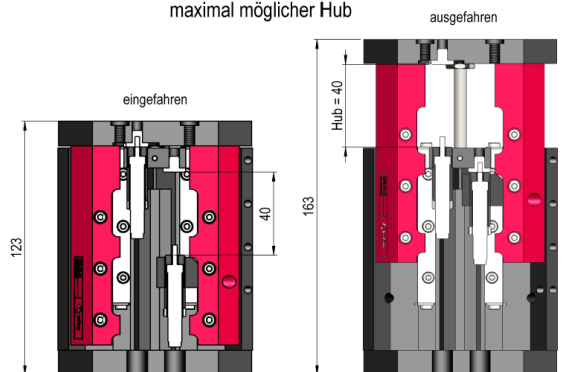

Hubbereich HM 16/40

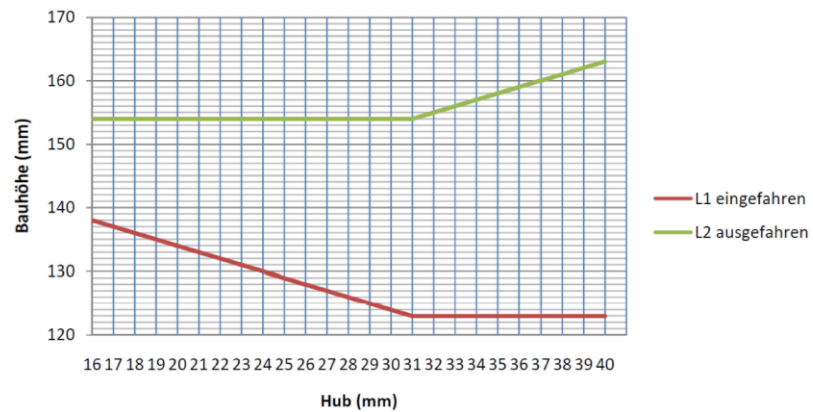

3.3 Stroke module HM 25

3.3.1 Dimensional drawing HM 25

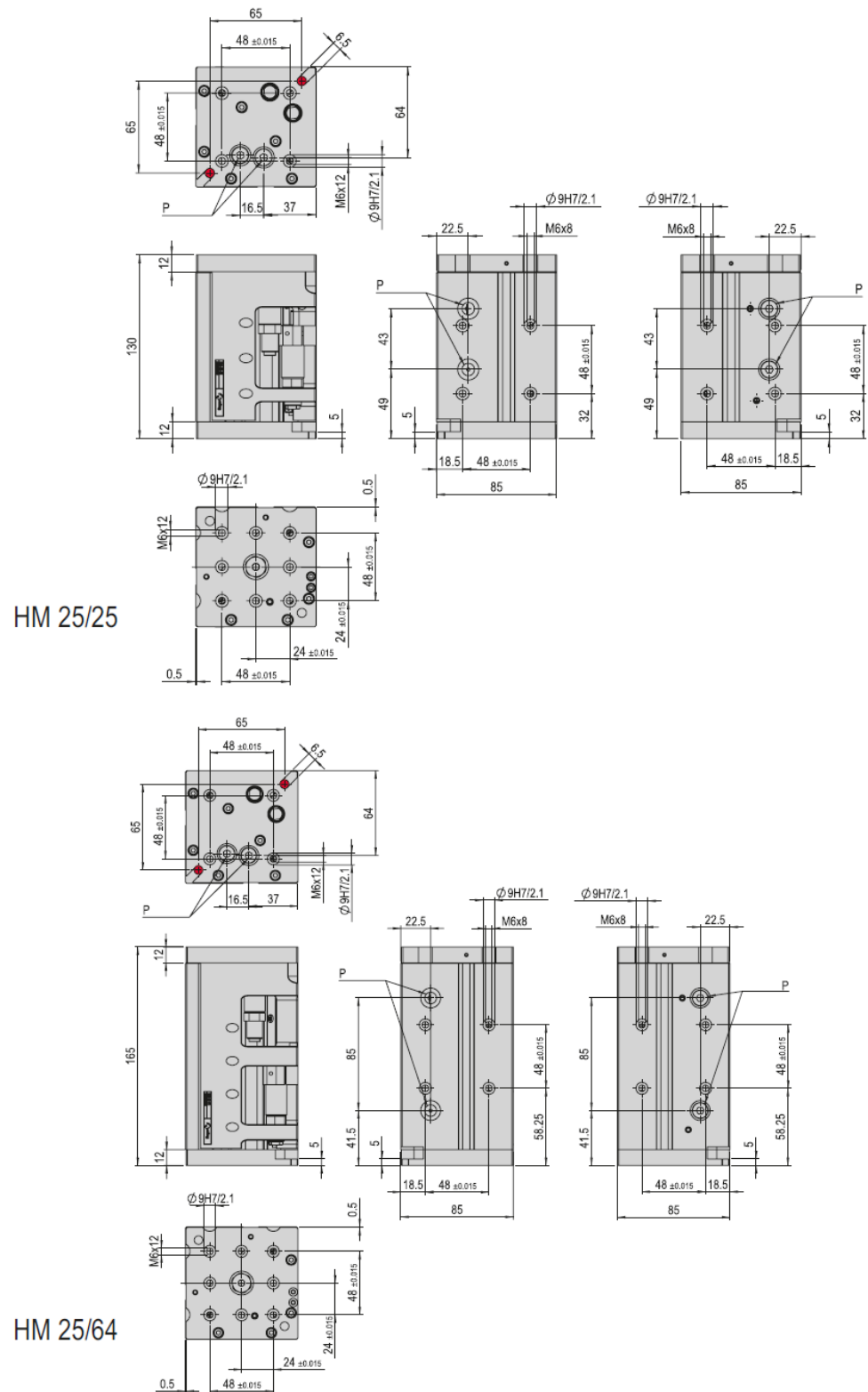

Bohrungen sind durchschraubbar

Fig. 5 Dimensional drawing - HM 25

3.3.2 Technical data HM 25

HM 25	
Attachment grid	48 x 48 mm
Attachment thread	M6
Operating pressure	6 +/- 2 bar
Air connection P	G 1/8 "
Cylinder Ø	25 mm
Retract piston force	247 N
Extend piston force	295 N
Operating temperature	0 - 50 °C
Storage temperature	0 - 50 °C
Humidity	< 90 %
Medium filtered compressed air	10 - 40 µm

Type	HM 25/25	HM 25/64
Order number	50287744	50287745
Stroke H	25 mm	64 mm
Net weight	2.168 kg	2.661 kg
Max. payload	10 kg	9 kg
Air consumption/cycle	0.104 NL	0.266 NL
Noise level	< 65 dB (A)	< 65 dB (A)
Repeat accuracy	+/- 0.01 mm	+/- 0.01 mm
Load balance (LA)	70 N	70 N
Mounting position	✚	✚

The technical data refer to a nominal pressure of 6 bar under Afag standard test conditions.
 Note: The load balance supports the extension stroke and damps the retraction stroke.
 The module can be operated with lubricated or dry air.
 Cleanroom class ISO 14644-1, class ISO 7

Included in the delivery
 (Catalogue HT accessories)

- 2x Centering bushing Ø9x4
- 2x Mounting screw M6x16
- 2x Stop sleeve ASH M16x1 -1
- 2x Washer M6
- 2x Shock absorber SD M12x1 -1

Accessories

(Catalogue HT accessories)

- INI c10x28.5-Em-PNP-NO-M8x1

Alternative accessories

(Catalogue HT accessories)

- INI c10x19.5-Em-PNP-NO-M8x1

Fig. 6 Technical data HM 25

3.3.3 Preferred combinations HM 25

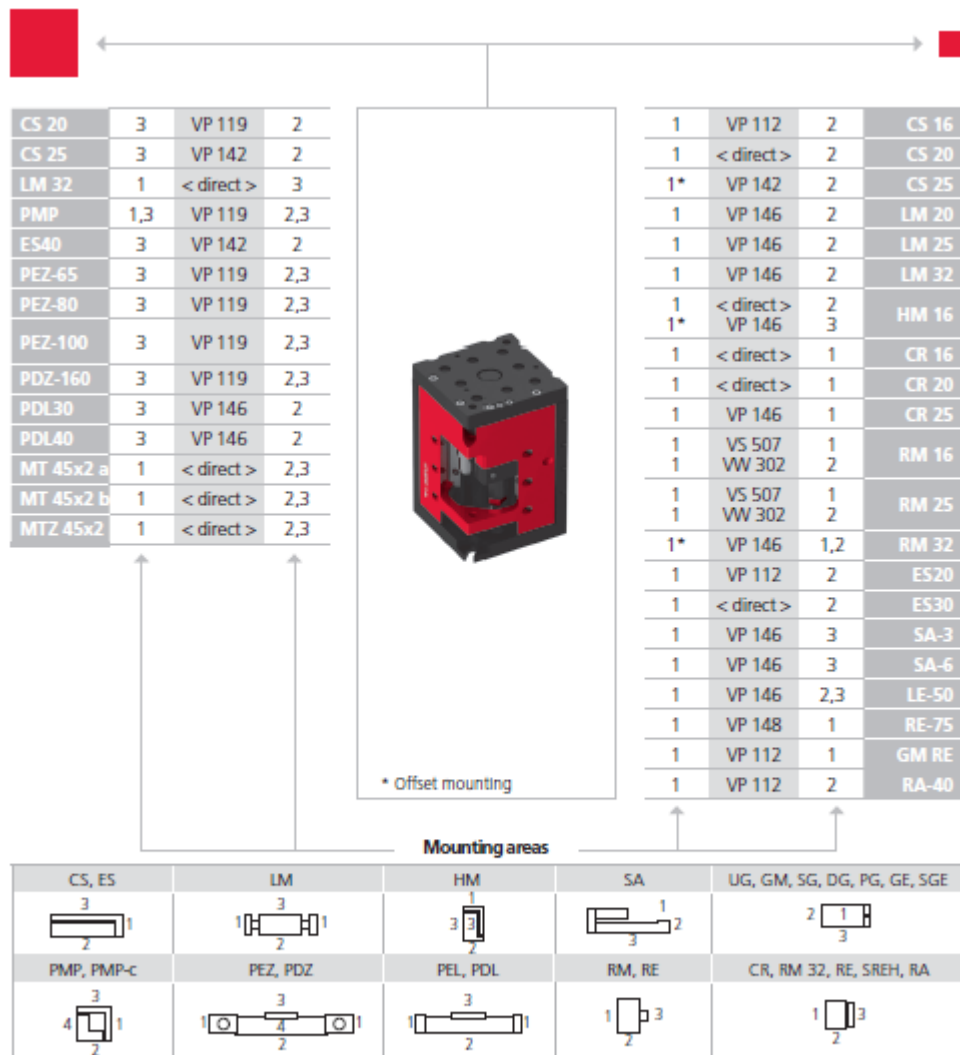

Note that there might be different mounting positions from one module to another one.
The required connection elements and the range of support columns are depicted in the catalogue HT accessories.

3.3.4 Module loads HM 25

Type	HM 25/25	HM 25/64
Max. static torque Mx	50 Nm	56 Nm
Max. static torque My	25 Nm	27 Nm
Max. static torque Mz	25 Nm	27 Nm
Max. effective force Fy	410 N	400 N
Max. effective force Fz	410 N	400 N
Effective distance Wx	60 mm	66.5 mm

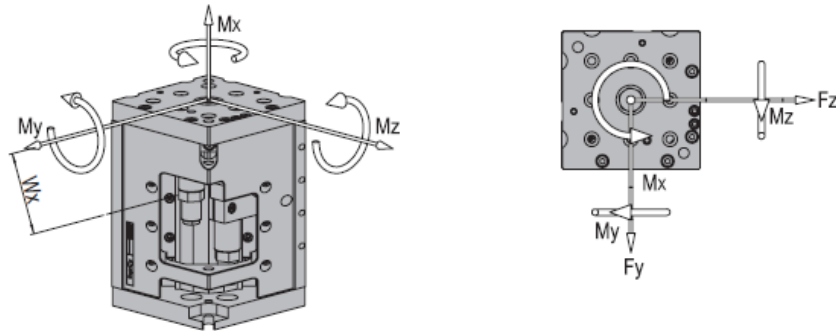
Operation time diagrams

Stroke times HM 25/25 extend vertically

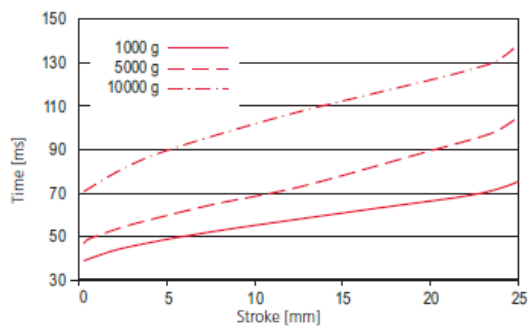

Stroke times HM 25/64 extend vertically

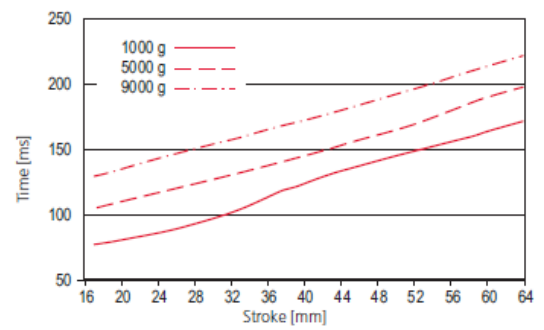

3.3.5 Diagrams stroke range HM 25/25 and HM 25/64

minimal möglicher Hub

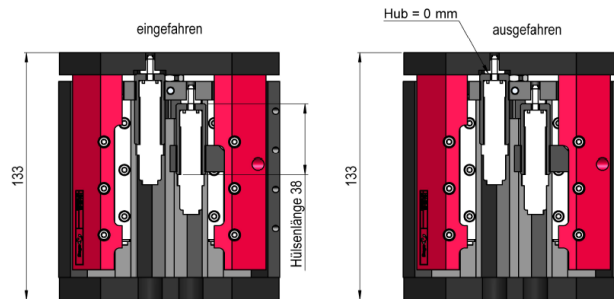

Hub bei kleinster Bauhöhe

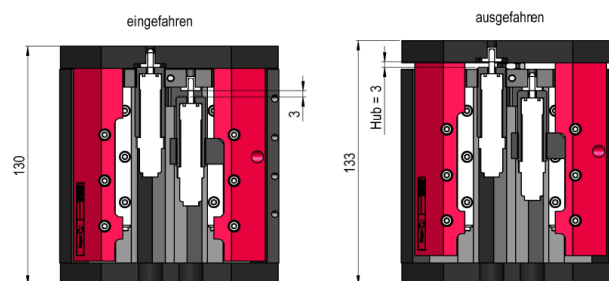

maximal möglicher Hub

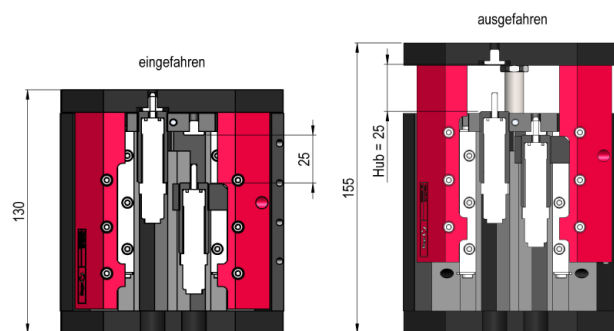

Hubbereich HM 25/25

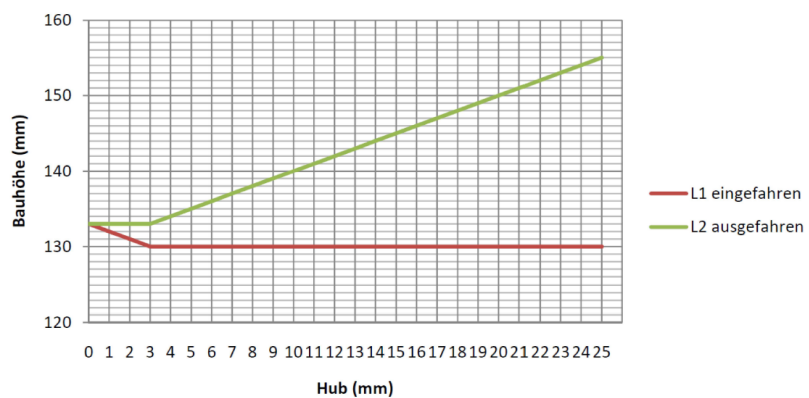

minimal möglicher Hub

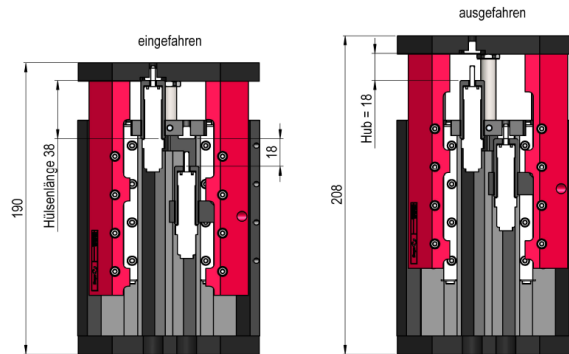

Hub bei kleinster Bauhöhe

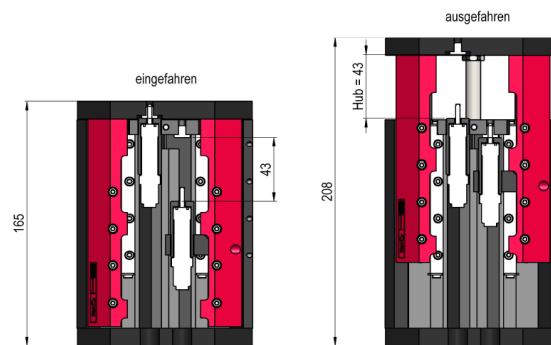

maximal möglicher Hub

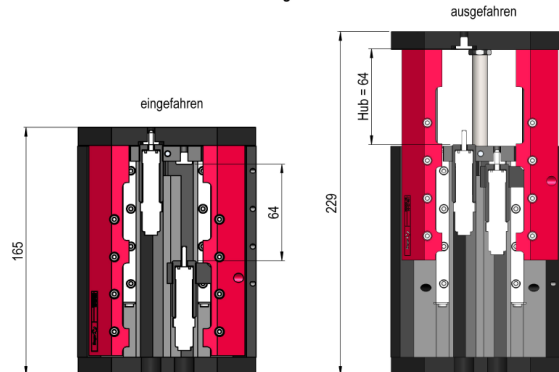

Hubbereich HM 25/64

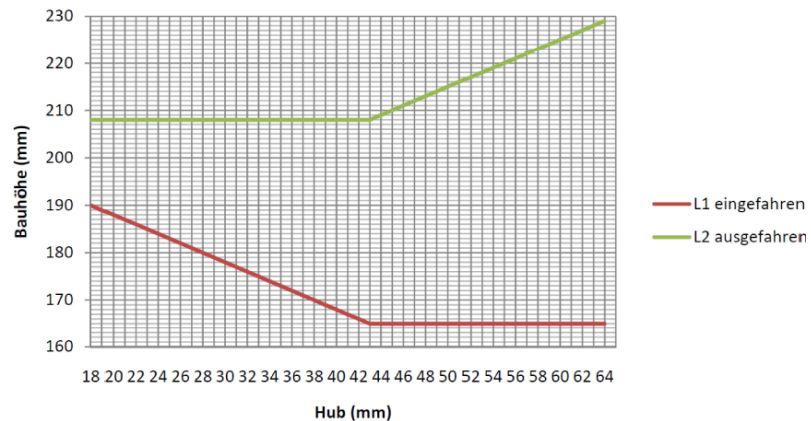

4 Transport, packaging and storage

4.1 Safety instructions for transport



The stroke module is a fine mechanical unit and must be handled with the necessary care and cleanliness during transport and storage as well as when handling, setting up and assembling!

CAUTION



Risk of injury when unpacking the module!

The stroke modules have a weight of 0.5 kg to 2.6 kg. If handled incorrectly, the module may fall out of the box when unpacked and cause limb injuries.

- Carefully unpack the stroke modules.

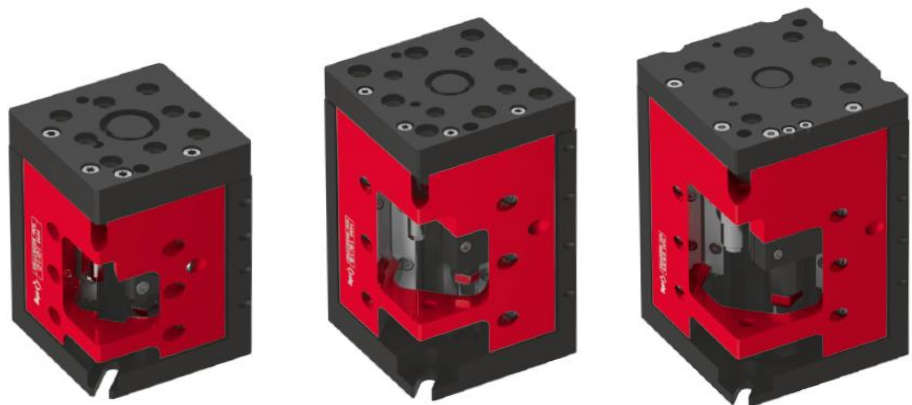

The delivery state of the modules is always extended due to the spring pressure of the integrated load balancer!



Also observe the safety instructions in  chap. 2 „Safety instructions“ in this manual.

4.2 Scope of supply



The scope of delivery of the modules includes assembly and operating instructions as well as a safety information sheet.

the assembly and safety information sheet must be read by every person who carries out work with and on modules!

[Unt]	Stroke module HM 10
1 x	Stroke module
2 x	Centering bushing Ø 7x3 mm
2 x	Fastening screws M4x8 mm
2 x	Fastening screws M4x12 mm
2 x	M4 washers
1 x	Installation instructions

[Unt]	Stroke module HM 16 and HM 25
1 x	Stroke module
2 x	Centering bushing Ø 9x4 mm
2 x	Fastening screws M6x16 mm
2 x	M6 washers
1 x	Installation instructions

4.3 Transport



No liability can be assumed for damages caused by improper installation on the part of the operating company.



The following conditions must be complied with for transport and storage:

- Storage temperature: 0-50 °C
- Relative air humidity: < 90%, non condensing

4.4 Packaging

The module is transported in the Afag Automation transport packaging. If no Afag packaging is used, stroke module must be packed in such a way that it is protected against shocks and dust.

NOTICE

Risk to the environment due to incorrect disposal of the packaging material.

Environmental damage can be caused by incorrect disposal of the packaging material.

- Dispose of the packaging material in an environmentally sensitive way in accordance with the local environmental regulations (➔ chap. 10.3).
-

4.5 Storage

If the stroke module is stored for an extended period, observe the following:

- Store the module in the transport packaging.
- Do not store the telescope spindle axes outdoors or expose them to weather conditions.
- The storage space must be dry and dust free.
- Room temperature of the storage space: 0-50 °C.
- Relative air humidity: < 90% non condensing.
- Clean the module and protect the blank metal parts against corrosion using the appropriate means.
- Protect the stroke module from dirt and dust.

5 Design and description

5.1 Structure of lifting module

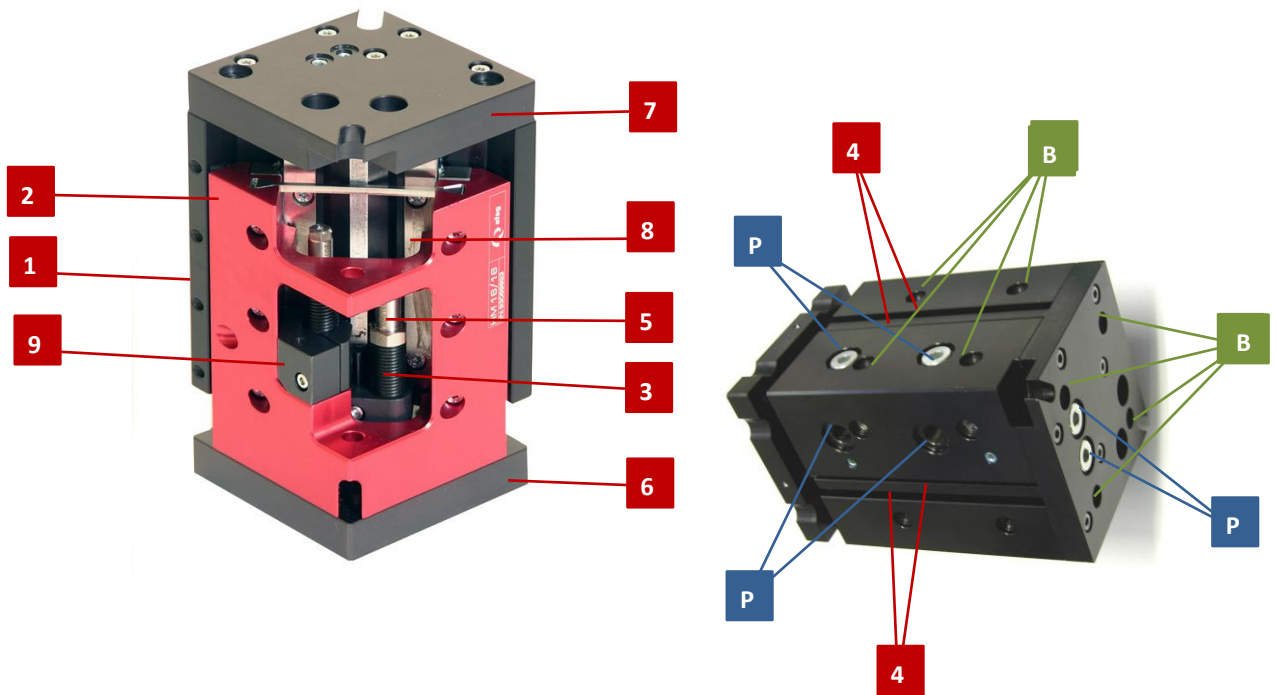

Fig. 7 Design of the stroke module

- | | |
|---|----------------------------------|
| 1. Base body | 7. Slide plate |
| 2. Slide | 8. Guides |
| 3. Stop sleeve | 9. Stop holder |
| 4. Slot for magnetic sensor (2x2 slots) | P = Pneumatic connections |
| 5. Shock absorber | B = Mounting holes |
| 6. Base plate | |

5.2 Product description

The stroke modules are pneumatically operated devices for linear movements from 0 to 64 mm stroke. All modules are delivered ready for installation according to the customer's order.

The stroke module consists of the base body (Fig. 7, 1), a cylinder, the pneumatic connections (Fig. 7, 10) as well as the movable slides (Fig. 7, 2). A double-acting piston driven by compressed air generates the longitudinal movement. The infinitely adjustable stop screws limit the stroke. The end positions are each adjusted via a stop sleeve (Fig. 7, 3).

The movement into the end positions is damped by a hydraulic shock absorber (Fig. 7, 5). Magnetic sensors (not included in the scope of delivery → chap. 5.3 accessories) can be attached in the C-slots (Fig. 7, 4) for sensing the end positions.

5.3 Accessories

INI c10x28.5-Em-PNP-NO-M8x1

Order number	50033432
Net weight	0.02 kg
Operating voltage	10 - 30 VDC

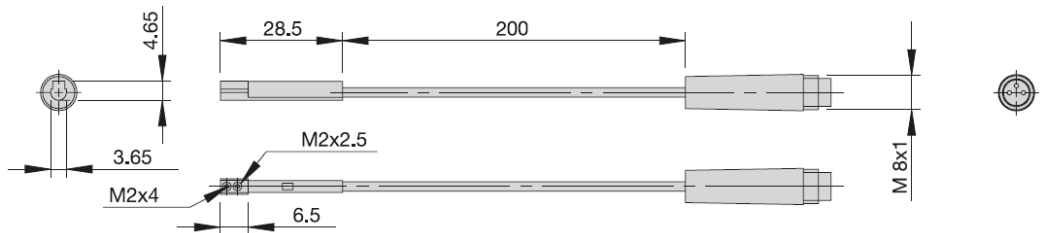

INI c10x19.5-Em-PNP-NO-M8x1

Order number	50313987
Net weight	0.021 kg
Operating voltage	10 - 30 VDC

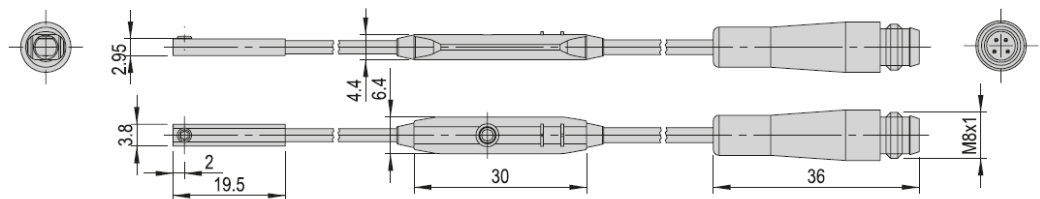

6 Installation, assembly & setting



The system operator is responsible for the installation of the stroke modules in a system!

When integrating a stroke module into an assembly system, the customer must provide an appropriate enclosure or safety barrier.

6.1 Safety Instructions for Installation & Assembly

The stroke modules are incomplete machines. For safe operation, the stroke modules must be integrated into the safety concept of the system in which they are installed. During normal operation, it must be ensured that the user cannot interfere with the working area of the modules.

CAUTION



Risk of injury when installing the stroke module in a system!

Improperly performed work can lead to injuries and damage to property.

- The installation may only be carried out by a qualified specialist!

CAUTION



Risk of injuries due to uncontrolled parts movements!

When operating the stroke module uncontrolled movements may occur which cause personal injury or property damage.

- When connecting the compressed air supply for the first time, make sure that all compressed air throttles are closed.
- Vent the system slowly!

CAUTION



Risk of injury due to mounted components!

Attachments to the stroke modules can be a hazard in connection with the moving carriages if the modules cannot move freely.

Take appropriate measures to ensure safe operation!



No liability for damages can be assumed for damages caused by improper installation/assembling work on the part of the operator.



Also observe the safety instructions in ↻ chap. 2 „Safety instructions“ in this manual.

6.2 Assembly and attachment



The modules can be installed in **vertical and horizontal** position!

6.2.1 Attachment options

The stroke modules can be screwed through for fastening. Use the Allen keys listed below.

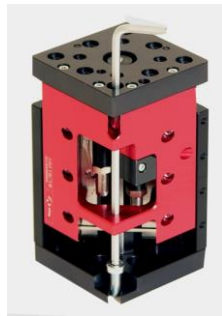

Types:	HM 10	HM 16	HM 25
Key:	3 mm	4 mm	4 mm



Fig. 8 Bolt-through stroke modules

Vertical installation position

Horizontal installation position

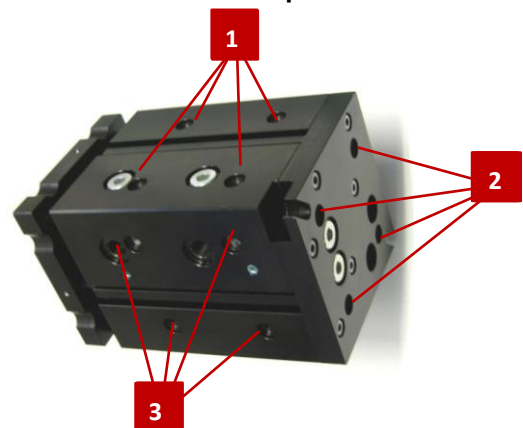

1: Horizontal installation 2: Bottom plate down 3: Thread

Fig. 9 Vertical and horizontal installation position

CAUTION



Risk of injury due to sudden movements when installed in vertical position!

When installed in a vertical position, unexpected movements may occur if the slide is not in its lowest position.

- Always move the slide to the lowest position before mounting.



When mounting vertically, make sure that the piston rod points upwards. This means that the maximum piston force is available for the upward movement.

To position the modules, insert the centring sleeves supplied bushings in two diagonally opposite holes.

6.2.2 Tightening torques

Use screws with the following minimum specifications for mounting:

Standard	VDI 2230
Strength:	Category 8.8
Surface:	Galvanized blue, oiled or greased

Thread	Tightening torque
M2	0.3 ... 0.35 Nm
M2.5	0.5 ... 0.73 Nm
M3	1.1 ... 1.4 Nm
M4	2.6 ... 3.3 Nm
M5	5.2 ... 6.5 Nm
M6	9.0 ... 11.3 Nm
M8	21.6 ... 27.3 Nm

6.3 Pneumatic connections



The unused pneumatic connections must be sealed airtight with the supplied screw plugs.



When connecting the compressed air supply for the first time, make sure that all compressed air throttles are closed. Vent the system slowly. **Operating pressure: 6 bar +/- 2**

There are 2 pneumatic connections HM 10 (M3); HM 16 (M5); HM 25 (G 1/8") each on the right and left side and at the bottom of the base body.

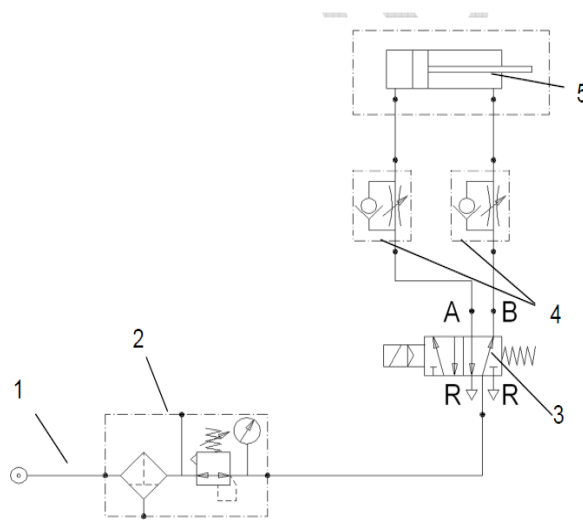

Fig. 10 Pneumatic connection stroke module

- | | |
|---------------------------------|-------------------|
| 1. Compressed air (6 bar +/- 2) | 4. Throttle valve |
| 2. Maintenance unit | 5. Stroke module |
| 3. Way valve 5/2) | |

The module can be connected directly via a mounting plate:



Fig. 11 Bottom module plate

1. Remove locking pin
2. Insert the O-rings from the accessory kit into the holes and connect them.

6.4 Installation of the initiator

WARNING



Risk of explosion!

The initiators must not be used in an explosive environment!

- Only use stroke modules and initiators in **non-hazardous** environments!

Contact bar with magnet

Two C-slots are provided on each side of the lifting modules for inserting the proximity switches. With the initiators, the end positions can be determined. A LED indicates the switching status.

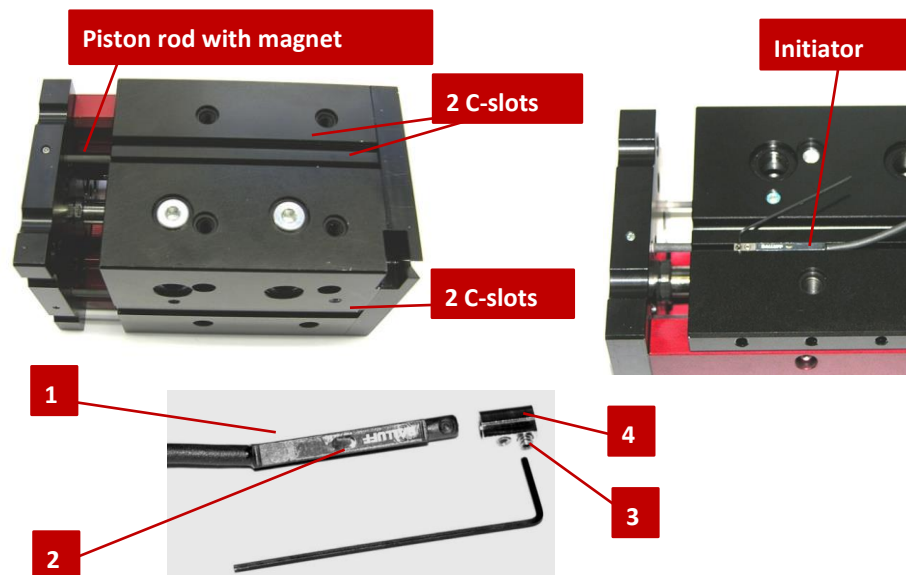

Fig. 12 Mounting the proximity switches

For assembly the initiator proceed as follows:

1. Insert holder (Fig. 12, 1) with clamping piece (Fig. 12, 4) into C-slots.
2. Roughly adjust the initiator and tighten it slightly with the screw (Fig. 12, 3).
3. Adjust the end positions and fasten the initiators completely.
4. Carry out a function check (LED 2 indicates the switching status).
⇒ The initiator is mounted.

7 Commissioning

After connection, the modules are put into operation for the first time via the system controller.

7.1 Safety instructions for commissioning

CAUTION



Risk of injuries due to uncontrolled parts movements!

When the control system is switched on, the stroke module can make unpredictable movements and cause injury or damage to property.

- Before working on the module, make sure that the controller is switched off and secured against being switched on again.
 - Connect or disconnect the cables only when the control is switched off.
 - Ensure that there are no persons/tools in the working area!
-

CAUTION



Risk of injury by reaching into the working area!

During normal operation, it must be ensured that the user cannot interfere with the working area of the stroke modules.

- The operator can provide suitable protective measures such as enclosures, light barrier or disconnecting the drive from the power supply.
-

CAUTION



Danger of injury in the working area of the module!

Due to the decentralised control system, the operator of the stroke module must not necessarily stand next to the module the slide so that he may not have a complete view of the working area. Persons during operation in the working area may be injured.

- When operating the stroke module, ensure a good overview of the entire working area.
 - Unauthorized persons must not stay within the working area during operation.
 - When working on the stroke module, switch off the regulator and compressed air and secure against being switched on again.
-



Observe the safety instructions in ➔ chap. 2 „Safety instructions“ of these assembly instructions!

7.2 Preparatory activities for commissioning



Before commissioning, adjust the shock absorbers and stop screws so that the desired angle of rotation is damped correctly.

7.2.1 Adjustment of the shock absorber

To achieve a smooth movement sequence, the stroke movement is braked in the end position against the stop screws by means of shock absorbers.

Tool	HM 10	HM 16	HM 25
Fork ring spanner	SW 9	SW 10	SW 14
Fork ring spanner	SW 5	Size 6	Size 8
Allen key	SW 2	SW 2.5	SW 2.5
Allen key		SW 2	



Procedure for adjusting the shock absorbers:

I. Position retracted:

1. Loosen the M8x1 lock nut (A).
 2. Turn the shock absorber to the end position (B).
 3. Tighten the lock nut (C).
- ⇒ The setting for the retracted position is completed.

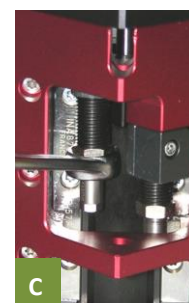

II. Position extended:

1. Loosen the M8x1 lock nut (D).
 2. Turn the shock absorber by hand to the end position (E).
 3. Tighten the lock nut (F).
- ⇒ The setting for the extended position is completed.

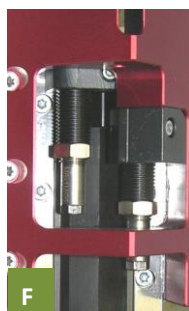
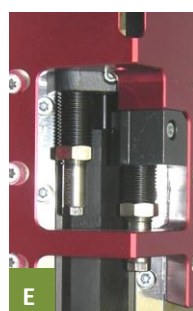

7.2.2 Setting the stroke (under pressure)

CAUTION

Risk of injuries due to uncontrolled parts movements!

The module is under pressure! This can cause sudden movements of the moving parts, which can cause crushing injuries!

- Proceed with the adjustment work carefully and in accordance with the instructions!

Procedure for setting the stroke:
I. Position retracted:

1. Loosen the locking screw (A)
 2. Turn stop sleeve to the end position (B)
 3. Tighten the locking screw (C).
- ⇒ The setting for the retracted position is completed.

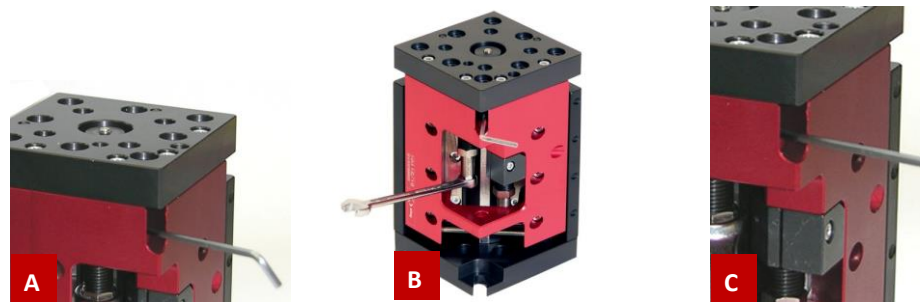
II. Position extended:

1. Loosen the locking screw (D).
 2. Turn the stop sleeve to the end position (E).
 3. Tighten the locking screw (F).
- ⇒ The setting for the extended position is completed.



7.3 Commissioning of the modules

Proceed carefully and follow the instructions step by step when commissioning the modules for the first time:

1. Slowly ventilate the entire system.
 2. Observe permissible values (⇒ chap. 3 Technical data):
 - Payload
 - Operating pressure
 - Movement frequency
 - Moment load
 3. Make sure that there are no persons or tools in the working area of the modules.
 4. Perform test run:
 - Start with slow movements.
 - subsequently under normal operating conditions.
- ⇒ Commissioning is completed.

8 Fault elimination

8.1 Safety instructions for troubleshooting

WARNING



Danger of injury due to faulty troubleshooting!

Poorly performed troubleshooting work can lead to serious injuries and damage to property.

- Only use trained specialist personnel for troubleshooting.
- All work on the module must be carried out with the power supply cut off!



Also observe the safety instructions in ↻ chap. 2 „Safety instructions“ in this manual.

8.2 Fault causes and remedy

Fault	Possible cause	Remedy:
Module does not retract or extend	<ul style="list-style-type: none"> ▪ No compressed air ▪ Module incorrectly connected 	<ul style="list-style-type: none"> ▪ Check connections ▪ Check connections
End position no signal	<ul style="list-style-type: none"> ▪ Limit stop screw incorrectly adjusted ▪ Initiator defect ▪ Cable break in sensor cable 	<ul style="list-style-type: none"> ▪ Correct the setting of the stop screw ▪ Replace initiator ▪ Replace proximity switch cable
Module hits the end positions	<ul style="list-style-type: none"> ▪ Shock absorber incorrectly adjusted ▪ Shock absorber defective ▪ No shock absorber available ▪ Exhaust flow control defective ▪ Lifting speed too high 	<ul style="list-style-type: none"> ▪ Readjust shock absorber ▪ Replace shock absorber ▪ Retrofitting of shock absorber ▪ Replace exhaust flow control ▪ Adjust exhaust flow control
Payload swings in the end position	<ul style="list-style-type: none"> ▪ Lifting speed too high ▪ Suboptimal damping ▪ Unfavourable installation position ▪ Unfavourable type 	<ul style="list-style-type: none"> ▪ Adjust exhaust flow control ▪ Optimise damper type, stroke ▪ Adaptation of the construction ▪ Use larger type



Defective components must be replaced exclusively by original spare parts.

9 Maintenance and repair

9.1 General notes

The following maintenance activities can ensure optimum operating condition of the stroke modules.

9.2 Safety instructions for Maintenance and Repair

WARNING



Danger of injury due to improper maintenance!

Improperly carried out maintenance activities can cause considerable damage to property and serious injury.

- Only use trained specialist personnel to carry out the activities.
 - Always wear personal protective equipment when carrying out maintenance and repair work!
-

CAUTION



Risk of injury from pneumatics!

When operating the modules uncontrolled movements may occur which cause personal injury or property damage.

- Only work on the module when the system is vented and deactivated!
-

CAUTION



Risk of injury due to uncontrolled movements of the module!

Signals from the control system can trigger unintentional movements of the servo gripper, which can cause injury.

- Before starting any activities, switch off the controller and secure it from being switched on again!
 - Observe the operating instructions of the controller used!
-



Also observe the safety instructions in ➔ chap. 2 „Safety instructions“ in this manual.

9.3 Maintenance activities and maintenance intervals



9.3.1 Overview of the maintenance points



Observe the specified maintenance and care intervals. The intervals apply to normal operating conditions and are to be shortened accordingly for other conditions.



Fig. 13 Maintenance of stroke module (exemplary HM 16)

No.	Maintenance point	Maintenance work	Interval	System [On/Off]	Remarks
1	Fastening elements	check 	Regularly	[Off]	- <ul style="list-style-type: none">Check fastening elements for tight fit.
2	Stroke module	Cleaning 	As required	[Off]	<ul style="list-style-type: none">With lint-free, dry clothDo not spray module with water, do not use aggressive cleaning agents.

9.3.2 Further maintenance

Further maintenance is not required, if the ambient conditions listed below are complied with:

- Clean working area
- No use of splash water
- No abrasive or process dust and vapours
- Environmental conditions as specified in the technical data

9.3.3 Compressed air specification

The modules are lifetime lubricated and can be operated with lubricated or non-lubricated compressed air.

Compressed air specification

Dry (condensation-free)

Filtered (40 µm filter for oil-lubricated air)

Filtered (5 µm filter for oil-lubricated air)

If the modules are operated with lubricated compressed air, we recommend that you use the following types of oil:

oil type	
Festo Special Oil	Shell Tellus Oel C 10
Avia Avilub RSL 10	Mobil DTE 21
BP Energol HPL 10	Blaser Blasol 154
Esso Spinesso 10	

Oil quantity: 5-10 drops of oil per 1000 ltr. Compressed air

Viscosity range: 9 to 11 mm²/s (= cST) at 40°C, ISO class VG 10 according to ISO 3448.

NOTICE

Risk of damage to property!

The operation of the modules with oil-lubricated compressed air causes the factory primary lubrication to be washed out. Therefore, it is essential that the modules continue to be operated with oil-lubricated compressed air in order to avoid damage to the modules.

- Once the modules have been operated with oil-lubricated compressed air, they **may never** be operated without oil-lubricated compressed air.

NOTICE

Material damage due to incorrectly adjusted, defective or missing shock absorbers!

Incorrectly adjusted, missing or defective shock absorbers impair the function of the module and can lead to its destruction!

- Always operate the stroke module with shock absorbers.
- Check shock absorbers for correct adjustment and function!

NOTICE

Risk of corrosion!

When used in ionised air environments (e.g., high voltage processors/corona ionisation), the modules may corrode.

- Regularly coat open flanges/shafts as well as guides and tongs with lubricant.
- We recommend monthly cleaning and lubrication according to Afag standard:
 - Staburax NBU8EP (flat guides)
 - Blasolube 301 (piston rod)

9.4 Spare and wear parts lists

9.4.1 General notes

Afag Automation AG offers a reliable repair service. Defective compact slides can be sent to Afag for warranty repair within the warranty period.

After the official warranty period has expired, wear parts can be replaced by the customer. Other defective module parts may only be replaced by Afag!



Please note that Afag does not assume any warranty for compact slides that have not been replaced or repaired by Afag!

9.4.2 Safety instructions

CAUTION



Danger of injury when dismantling the modules!

If pneumatic connections are disconnected under pressure, sudden rapid movements of moving parts can cause serious injuries!

- Only remove the modules when the system is vented and deactivated!



Damaged modules may only be replaced or repaired by Afag!

Please note that AFAGF does not assume any warranty for telescope spindle axis that have not been replaced or repaired by AFAG!

9.4.1 Spare parts

Seq. No.	Spare parts	Order Number
1	Shock absorber SD M6x0.5-3 (to HM 10)	50287720
2	Shock absorber SD M8x1-5 (to HM 16)	50288020
3	Shock absorber SD M12x1-1 (to HM 25)	50287972

For retrofitting the 1 module generation

Seq. No.	Spare parts	Order Number
1	Set load compensation LA-HM 10/10	50320992
2	Set load compensation LA-HM 10/25	50320993
3	Set load compensation LA-HM 16/16	50320994
4	Set load compensation LA-HM 16/40	50320995
5	Set load compensation LA-HM 25/25	50320996
6	Set load compensation LA-HM 25/64	50320997

9.5 Repair and overhaul

9.5.1 Dismantling the extension shock absorbers

The following tools are required for removing the shock absorbers:

Type	HM 10	HM 16	HM 25
Allan key:	SW 2 mm	SW 2.5 mm	SW 2.5 mm

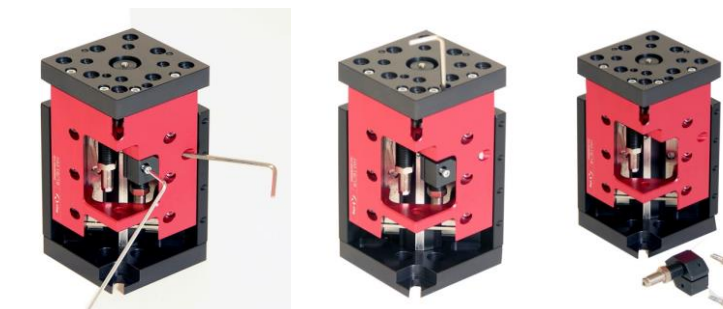

After removing the holders, the defective shock absorber can be replaced (order number of the shock absorbers → chap. 5.3 Accessories).

9.5.2 Replacing the retractable shock absorber

Defective shock absorbers can be replaced with the corresponding accessories of the respective module type (→ chap. 5.3 Accessories).

Procedure:

1. Loosen the lock nut.
 2. Loosen and remove the defective shock absorber.
 3. Insert and fix the new shock absorber.
 - Adjust new shock absorber (→ chap. 7.2.1)
 4. Tighten the lock nut.
- ⇒ The retractable shock absorber has been replaced.

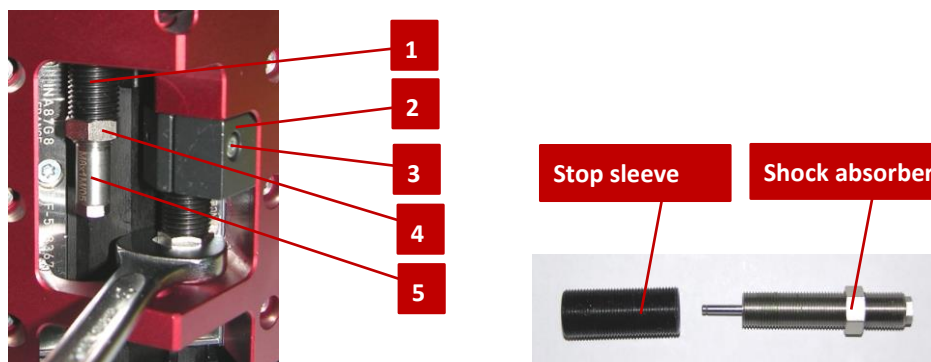

Fig. 14 Replacing the retractable shock absorber

1. Stop sleeve
2. Stop holder
3. Clamping screw
4. Lock nut (retract shock absorber)
5. Extend shock absorber

9.5.3 Remove load compensation of the lifting module

The HM modules are equipped with load compensation as standard.

The load compensation is taken over by a compression spring on the piston rod. The load compensation supports the extension stroke and dampens the retraction stroke. This increases the service life of the shock absorbers.



If the load compensation is not required for your application, the pressure spring in the module can also be removed (→ chapter 9.4.4).

9.5.4 Remove the pressure spring of the load compensation

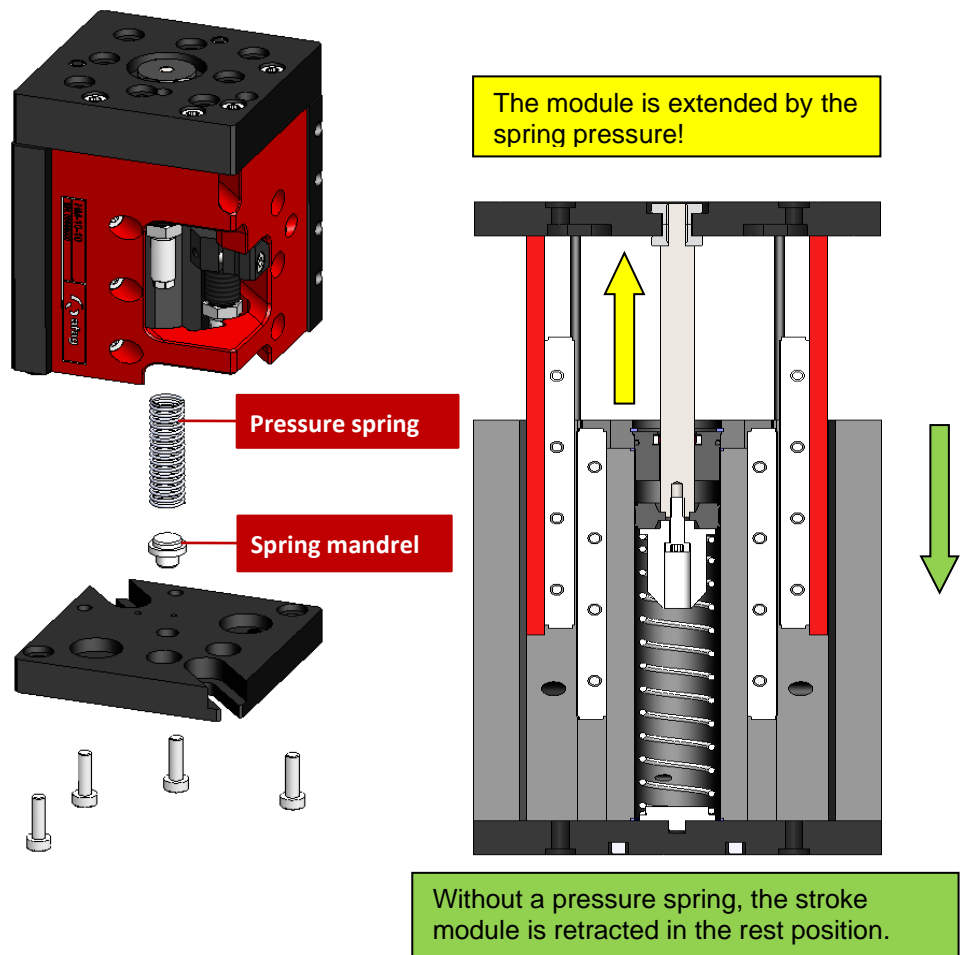

Procedure:

1. Loosen and remove four screws on the base plate.
 2. Carefully lift off the base plate.
 3. Remove the pressure spring from the cylinder bore.
 4. Remove the spring pin from the base plate.
 5. Carefully place the base plate back onto the module body.
 6. Insert and tighten four screws.
- ⇒ The pressure spring is removed.

10 Decommissioning, disassembly, disposal

The stroke modules must be properly dismantled after use and disposed of in an environmentally friendly manner.

10.1 Safety instructions

WARNING



Risk of injury due to improper decommissioning, disassembly and disposal!

Improperly carried out activities can result in considerable material damage and serious injury.

- Only use trained specialist personnel to carry out the activities.
 - Disconnect the media supply (pneumatics) before removing the modules!
 - Only remove module when the controller is switched off and secured!
-



Also observe the safety instructions in ➔ chap. 2 „Safety instructions“ in this manual.

10.2 Decommissioning

If the stroke modules are not used for a longer period, they must be properly commissioned and stored as described in ➔ chapter 4.5.

10.3 Disposal

The module must be disposed of properly at the end of their service life and the raw materials used must be recycled. Observe the legal regulations and company requirements.

The stroke modules must not be disposed of as a complete unit. Dismantle the stroke module and separate the various components according to type of material and dispose of them properly:

- Scrap the metallic materials.
- Hand over plastic parts for recycling.
- Sort the rest of the components by their material properties and dispose of them accordingly.

NOTICE

Risk to the environment due to incorrect disposal of the packaging material of the module!

Environmental damage can be caused by improper disposal of the modules.

- Electronic parts, electrical scrap, auxiliary and operating materials must be disposed of by approved specialist companies.
 - Information on proper disposal can be obtained from the responsible local authorities.
-

11 Declaration of incorporation

Declaration of incorporation

for partly completed machinery according to the Machinery Directive 2006/42/EC, Annex II, 1.B

The manufacturer hereby declares:

Afag Automation AG, Luzernstrasse 32, CH-6144 Zell

that the partly completed machine:

Product description	Stroke module HM 10, HM 16, HM 25
Type:	HM 10/10, HM 10/25, HM 16/16, HM 16/40, HM 25/25, HM 25/64

complies with the following essential health and safety requirements of the Machinery Directive 2006/42/EC at the time of declaration: 1.1; 1.1.1; 1.1.2; 1.2.3; 1.2.4.4; 1.3; 1.3.5; 1.3.6; 1.3.7; 1.3.9; 1.4.1; 1.5; 1.5.3; 1.6; 1.6.1; 1.6.3; 1.6.4; 1.7; 1.7.4; 1.7.4.1; 1.7.4.2; 1.7.4.3.

Harmonised standards applied, in particular:	
EN ISO 12100:2010	Safety of machinery - General design principles - Risk assessment and risk reduction.

Note: The partly completed machinery must not be put into service until the machinery into which it is to be incorporated has been declared in conformity with the provisions of Machinery Directive 2006/42/EC.

The manufacturer undertakes to transmit, in response to a reasoned request by the national authorities, relevant technical documentation for the partly completed machinery.

The relevant technical documentation was created according to Annex VII, Part B of the above-mentioned Directive .

Authorised representative for compiling the technical documentation:

Niklaus Röthlisberger, Product Manager, Afag Automation AG, CH-6144 Zell

Zell, 31.05.2023

Adrian Fuchser



CEO Afag Gruppe

Klaus Bott



CTO Afag Gruppe

Afag Automation AG
Luzernstrasse 32
6144 Zell
Switzerland
T +41 62 959 86 86
sales@afag.com

Afag GmbH
Wernher-von-Braun-Straße 1
92224 Amberg
Germany
T +49 9621 650 27-0
sales@afag.com

Afag Engineering GmbH
Gewerbestraße 11
78739 Hardt
Germany
T +49 7422 560 03-0
sales@afag.com

Afag Automation Americas
Schaeff Machinery & Services LLC.
883 Seven Oaks Blvd, Suite 800
Smyrna, TN 37167
USA
T +1 615 730 7515
nashville@afag.com

Afag Automation APAC
Afag Automation Technology (Shanghai) Co., Ltd.
Room 102, 1/F, Bldg. 56, City Of Elite
No.1000, Jinhai Road, Pudong New District
Shanghai, 201206
China
T +86 021 5895 8065
shanghai@afag.com