

Assembly and operating instructions

Rotary-gripper module (pneumatic/electric)

GMQ 20 / RE-50

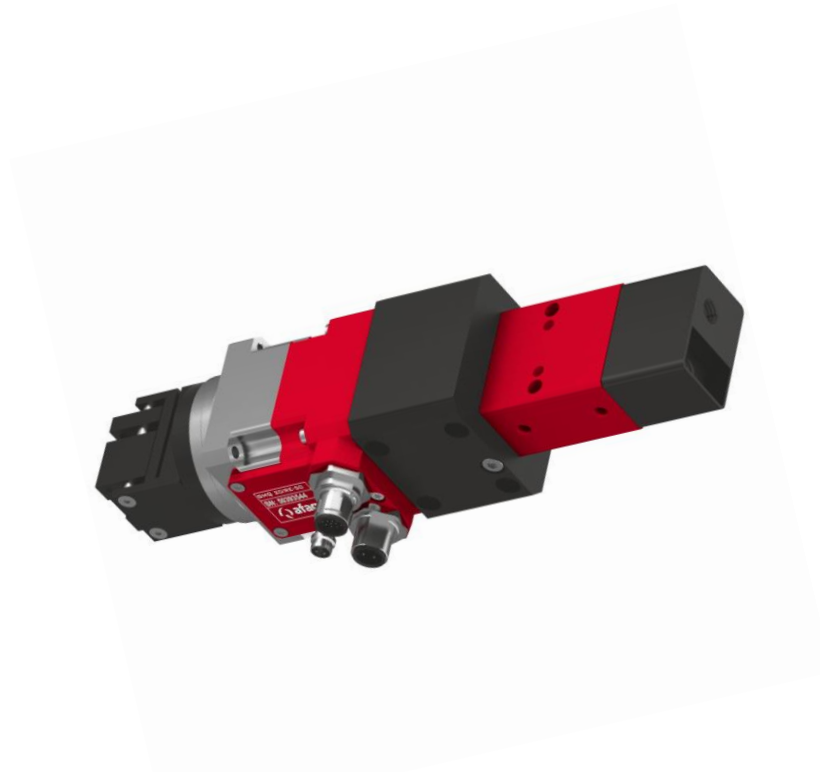

Translation of the Original Assembly Instructions EN

- | | |
|---------------------------------|-----------------------|
| ■ GMQ 20/K/ RE-50 | ⇒ Order no.: 50355546 |
| ■ GMQ 20/P/ RE-50 | ⇒ Order no.: 50355544 |
| ■ GMQ 20/P-01 / RE-50 | ⇒ Order no.: 50410326 |
| ■ GMQ 20/K / RE-50 (18-100V) | ⇒ Order no.: 50355549 |
| ■ GMQ 20/P / RE-50 | ⇒ Order no.: 50355547 |
| ■ GMQ 20/P-01 / RE-50 (18-100V) | ⇒ Order no.: 50410327 |

Dear Customer

Thank you for choosing our products and placing your trust and confidence in our company!

These assembly and operating instructions contain all essential information you need about your product. Our aim is to provide the required information as concisely and clearly as possible. If, however, you still have any questions on the contents or suggestions, please do not hesitate to contact us. We are always grateful for any feedback.

Our team will also be glad to answer any further question you may have regarding the rotary-gripper module or other options.

We wish you every success with our products!

With kind regards

Your Afag team

© Subject to modifications

The rotary modules have been designed by Afag Automation AG according to the state of the art. Due to the constant technical development and improvement of our products, we reserve the right to make technical changes at any time.

© Copyright 2023 Afag Automation AG

All contents of the present assembly and operating instructions, in particular the texts, photographs and graphics, are protected by copyright. All rights reserved. No part of these assembly and operating instructions may be reproduced, distributed (made available to third parties), or transmitted in any form or by any means, including photocopying, recording, or other electronic or mechanical methods, without the prior written permission of Afag Automation AG.

Afag Automation AG
Luzernstrasse 32
CH-6144 Zell (Switzerland)
Tel.: +41 62 959 86 86
e-mail: sales@afag.com
Internet: www.afag.com

Table of contents

1	General	5
1.1	Contents and purpose of these assembly instructions.....	5
1.2	Explanation of symbols.....	5
1.3	Additional symbols.....	6
1.4	Applicable documents	7
1.5	Warranty	7
1.6	Liability.....	7
2	Safety instructions	8
2.1	General	8
2.2	Intended use.....	8
2.3	Foreseeable misuse	8
2.4	Obligations of the operator and the personnel	9
2.4.1	Observe the assembly instructions	9
2.4.2	Obligations of the operating company.....	9
2.4.3	Obligations of the personnel	9
2.5	Personnel requirements	10
2.5.1	Personnel qualification	10
2.6	Personal protective equipment (PPE)	10
2.7	Changes and modifications	11
2.8	General hazards / residual risks.....	11
2.8.1	General hazards at the workplace	11
2.8.2	Danger due to electricity	12
2.8.3	Danger due to high temperatures	13
2.8.4	Mechanical hazards	13
3	Technical data	14
3.1	Rotary-gripper module GMQ 20	14
3.1.1	Dimensional drawing GMQ 20	14
3.1.2	Technical data GMQ 20	15
3.1.3	Preferred combinations	16
3.1.4	Diagrams gripping force GMQ 20	17
3.2	Rotary module RE-50 (without flange)	18
3.2.1	Dimensional drawing RE-50.....	18
3.2.2	Technical data RE-50.....	19
3.2.3	Preferred combinations	20
3.2.4	Load diagrams RE-50 (without flange)	21
4	Transport, packaging and storage	22
4.1	Safety instructions	22
4.2	Scope of supply	22
4.3	Transport	23
4.4	Packaging.....	23

4.5	Storage	23
5	Design and description	24
5.1	Design rotary-gripper module GMQ 20/RE-50	24
5.2	Product description	24
5.3	Accessories	25
6	Installation, assembly and setting	26
6.1	Safety instructions	26
6.2	Assembly & attachment	27
6.2.1	Fastening the module	27
6.2.2	Tightening torques	27
6.2.3	Electrical interfaces	29
6.3	Gripping jaws	30
6.3.1	Assembly of gripping jaws	30
6.3.2	Dismounting the gripping jaws	31
6.3.3	Manufacture of the gripper fingers	32
7	Commissioning	33
7.1	Safety instructions	33
7.2	Preparatory activities for commissioning	34
7.3	Commissioning of the modules	34
7.4	Setting-up and retrofitting	35
8	Fault elimination	37
8.1	Safety instructions	37
8.2	Fault causes and remedy	38
9	Maintenance and repair	39
9.1	General notes	39
9.2	Safety instructions	39
9.3	Maintenance activities and maintenance intervals	40
9.3.1	Overview of the maintenance points	40
9.3.2	Further maintenance	40
9.4	Repair and overhaul	41
9.4.1	Replacing the GMQ 20 gripper drive	41
9.4.2	Replacing the RE-50 rotary module	43
9.4.3	Replace end position sensor	44
9.5	Spare parts and repair work	45
10	Decommissioning, disassembly, disposal	46
10.1	Safety instructions	46
10.2	Decommissioning	46
10.3	Disposal	46
11	Declaration of incorporation	47

1 General

1.1 Contents and purpose of these assembly instructions

These assembly instructions contain important information on assembly, commissioning, functioning and maintenance of the rotary-gripper module GMQ 20/RE-50 to ensure safe and efficient handling and operation.

Consistent compliance with these assembly instructions will ensure:

- permanent operational reliability of the module,
- optimal functioning of the module,
- timely detection and elimination of defects (thereby reducing maintenance and repair costs)
- prolongation of the module service life.

The illustrations in this manual shall provide you with a basic understanding of the module and may vary from the actual design of your module.

1.2 Explanation of symbols

The safety notes are marked by a pictogram and a signal word. The safety notes describe the extent of the hazard.

DANGER



Danger!

This safety note indicates an imminently hazardous situation which, if not avoided, will result in death or serious injury.

WARNING



Warning!

This safety note points out a potentially hazardous situation which, if not avoided, could result in death or serious injury.

CAUTION



Caution!

This safety note points out a potentially dangerous situation which, if not avoided, can result in minor or slight injuries.

NOTICE

This safety note points out a potentially dangerous situation which, if not avoided, can cause substantial damage to property and the environment.



This note contains important additional information as well as useful tips for safe, efficient and trouble-free operation of the module.

Further warning signs:

Where applicable, the following standardised symbols are used in this manual to point out the various potential health risks.

	Warning - Dangerous electrical voltage.
	Warning - Risk of injury from contact with hot surfaces.
	Warning - Risk of hand and finger injury due to uncontrolled movements of components.
	Warning - Magnetic field
	Warning - back injury due to heavy lifting.
	Warning - Risk of injury as a result of parts being flung out!
	Warning - high noise levels.

1.3 Additional symbols

In these assembly instructions the following symbols are used to highlight instructions, results, references, etc..

Symbol	Description
1.	Instructions (steps ...)
⇒	Results of actions
↻	References to sections
■	Enumerations not ordered

1.4 Applicable documents

In addition to the assembly instructions, the following documents must be observed:

- Safety data sheets etc.
- Instructions for integrated components (📄supplier documentation)



Each rotary-gripper module is accompanied by a safety information sheet. This information sheet must be read carefully by every person who carries out work on and with the rotary-gripper module.

1.5 Warranty

The warranty terms for Afag handling components and handling systems are the following:

- 24 months from initial operation and up to a maximum of 27 months from delivery.
- Wear parts are excluded from the warranty (The customer is entitled to a product free of defects. *This does also apply to defective accessories and wear parts. Normal wear and tear are excluded from the warranty.*)

The warranty covers the replacement or repair of defective Afag parts. Further claims are excluded.

The warranty shall expire in the following cases:

- Improper use of the module
- Non-observance of the instructions regarding assembly, commissioning, operation and maintenance of the module.
- Improper assembly, commissioning, operation and maintenance
- Repairs and design changes carried out without prior technical instructions of Afag Automation AG
- Removing the serial number from the product
- Inadequate checking of wear parts
- Non-observance of the EC Machinery Directive, the Accident Prevention Regulations, the Standards of the German Electrotechnology Association (VDE) and these safety and assembly instructions.

1.6 Liability

No changes shall be made to the GMQ modules unless described in this instructions manual or approved in writing by Afag Automation AG.

Afag Automation AG accepts no liability for unauthorized changes or improper assembly, installation, commissioning, operation, maintenance or repair work.

2 Safety instructions

2.1 General

This chapter provides an overview of all important safety aspects to ensure safe and proper use of the gripper and optimal protection of personnel.



Failure to follow the directions and safety instructions given in this instructions manual may result in serious hazards.

2.2 Intended use

The GMQ module is intended for the shock-free gripping movement of loads in **non-hazardous** and in the ambient and operating conditions defined for this module (→ Chapter 3 Technical data).

The modules are designed exclusively for rotate payloads that do not pose any danger to persons, property or the environment during manipulation. In combination with other modules the GMQ can be used as a pick & place station.

Any use beyond the described purpose is not in accordance with the intended use.



The intended use of the module also includes:

- observance of all instructions given in this instructions manual.
- compliance with the inspection and maintenance work and the specifications in the data sheets,
- using only original spare parts.

2.3 Foreseeable misuse

Any use other than or beyond the intended use described above is considered a misuse of the rotary-gripper modules.

Especially the following use is considered a misuse:

- Use in potentially explosive atmospheres.

WARNING

Risk of injury if the module is not used as intended!

The improper use of the module poses a potential hazard to the personnel.

- The modules may only be used in a technically perfect condition in accordance with its intended use and the instructions in this manual as well as in compliance with the safety requirements!
- Any malfunctions, particularly those that could impair safety, must be eliminated immediately!





Risks can occur if the module is not used as intended. In the event of damages caused by improper use the following shall apply:

- the operating company shall be solely responsible for such damage, and
 - AFAG does not assume any liability for damage caused by improper use.
-

2.4 Obligations of the operator and the personnel

2.4.1 Observe the assembly instructions

A basic prerequisite for safe and proper handling of modules is a good knowledge of the basic safety instructions.



These assembly instructions, in particular the safety instructions contained therein, must be observed by all persons working with the modules.

2.4.2 Obligations of the operating company

In addition to the safety instructions given in this manual, the operating company must comply with the safety, accident prevention and environmental protection regulations valid for the field of application of the rotary-gripper modules.

The operator undertakes to allow only persons to the GMQ who:

- have the necessary professional qualifications and experience,
- are familiar with the basic rules regarding occupational safety and accident prevention,
- have been instructed in the correct handling of the modules,
- have read and understood these assembly instructions.

The operating company is also required to:

- monitor on an ongoing basis that the personnel work safely considering any potential hazard involved and the assembly instructions are observed,
- ensure that the assembly instructions are always kept at hand at the installation in which the modules are mounted,
- observe and communicate universally applicable laws and regulations regarding accident prevention and environmental protection,
- provide the necessary personal protective equipment (e.g. protective gloves) and instruct the personnel to wear it.

2.4.3 Obligations of the personnel

All personnel working with the modules are required to:

- read and observe these assembly instructions (especially the chapter safety),
 - observe the occupational safety and accident prevention regulations,
 - observe all safety and warning signs on the modules,
 - refrain from any activity that might compromise safety and health.
-



In addition, the personnel must wear the personal protective equipment required for carrying out their work. (➡Chapter 2.6).

2.5 Personnel requirements

2.5.1 Personnel qualification

The activities described in the assembly instructions require specific requisites at the level of professional qualifications of the personnel.

Personnel not having the required qualification will not be able to assess the risks that may arise from the use of the module thus exposing himself and others to the risk of serious injury. Therefore, only qualified personnel may be permitted to carry out the described activities on the modules.

Persons whose ability to react is restricted due to the intake of medication or the like must not interact with the stroke module.

These installation instructions are intended for skilled personnel (installers, system integrators, maintenance personnel, technicians), electricians and operating personnel.

The following is a description of the professional skills (qualifications) required for carrying out the different activities:

Qualified personnel:

Qualified personnel with appropriate training who are qualified due to their special know-how and fully familiar with the machine and who have been given instructions on how to carry out the task entrusted to them safely.

Qualified electrician:

Persons who have obtained their electrical qualifications through appropriate professional training and complementary courses that enables them to identify risks and prevent possible hazards resulting from electricity.

Operator (trained personnel):

Authorized persons who due to their specialized professional training, expertise and experience can identify risks and preventing possible hazards arising from the use of the machine.





2.6 Personal protective equipment (PPE)

The personal protective equipment serves to protect the personnel from hazards affecting their safety and health at work.

When working on/with the RM modules, the personnel must wear the personal protective equipment assigned by the safety officer of the operating company or as required by safety regulations. In addition, the personnel is required to:

- wear the personal protective equipment provided by the operating company (employer),
- check the personal protective equipment for proper condition, and
- immediately notify the person responsible on site of any defects found on the personal protective equipment.

Personal protective equipment and the respective mandatory signs:

	<p><i>Protective clothing</i> is a close-fitting clothing specifically designed to protect personnel from hazards during work.</p>
	<p><i>Protective gloves</i> are specifically designed to protect the personnel against hand injuries (such as cuts, abrasion, burns).</p>
	<p><i>Safety shoes</i> are specifically designed to protect the personnel against foot injuries from crushing, falling objects or slipping on slippery surfaces.</p>
	<p>Hearing protectors are required to protect the personnel against excessive noise levels to prevent noise-induced hearing loss.</p>

2.7 Changes and modifications

No changes may be made to the module which have not been described in these assembly instructions or approved in writing by Afag Automation AG.

Afag Automation AG accepts no liability for unauthorised changes or improper assembly, installation, commissioning, maintenance or repair work.



The GMQ module may not be changed or modified in any way, except with the prior written consent of Afag.

2.8 General hazards / residual risks

Despite the safe design of the machine and the technical protective measures taken, there still remain residual risks that cannot be avoided, and which present a non-obvious residual risk when operating the rotary modules.

Observe the safety instructions in this chapter and in the other sections of this manual to avoid damage to property and dangerous situations for the personnel.

2.8.1 General hazards at the workplace

The modules has been built according to the state-of-the-art and the applicable health and safety requirements. However, improper use of the module may cause the following hazards to the personnel:

- danger to life and limb of the operator or third parties,
- on the modules themselves,
- property damage.



Always keep the assembly instructions ready at hand at the workplace!
Please, also observe:

- the general and local regulations on accident prevention and environmental protection,
- the safety information sheet for the module.

WARNING



Danger - Do not use in unsuitable environment !

The modules are designed for use in **non** explosive atmospheres.

- Do **not** use the modules in potentially explosive atmospheres!

CAUTION



Risk of injury from being caught!

The rotational movements of the gripper jaws can catch pieces of clothing, hair or other materials and injure people.

- Activities should only be carried out by qualified personnel.
- Wear personal protective equipment!

CAUTION



Risk of injuries due to uncontrolled parts movements!

When connecting and operating the modules, unexpected movements can cause personal injury or damage to property.

- Only qualified personnel may work with or on the modules.

2.8.2 Danger due to electricity

DANGER



Danger! Risk of electric shock!

If work on electrical components is required, ensure that the work is carried out properly, failure to do so will cause serious or fatal injuries.

- Work on the machine's electrical equipment may only be performed by skilled electrician or trained personnel under the supervision of a skilled electrician in accordance with all relevant electrical regulations.

2.8.3 Danger due to high temperatures

CAUTION



Danger of injury from hot surfaces.

During continuous operation of the modules, the surface of the module heats up.

- Before touching hot surfaces without protective gloves, make sure they have cooled down to ambient temperature.
-

2.8.4 Mechanical hazards

CAUTION



Danger of injury by moving components!

Limbs can be crushed by moving components!

- Work on and with the modules may only be carried out by qualified personnel.
 - Never reach into the system during normal operation!
-

3 Technical data

3.1 Rotary-gripper module GMQ 20

3.1.1 Dimensional drawing GMQ 2 0

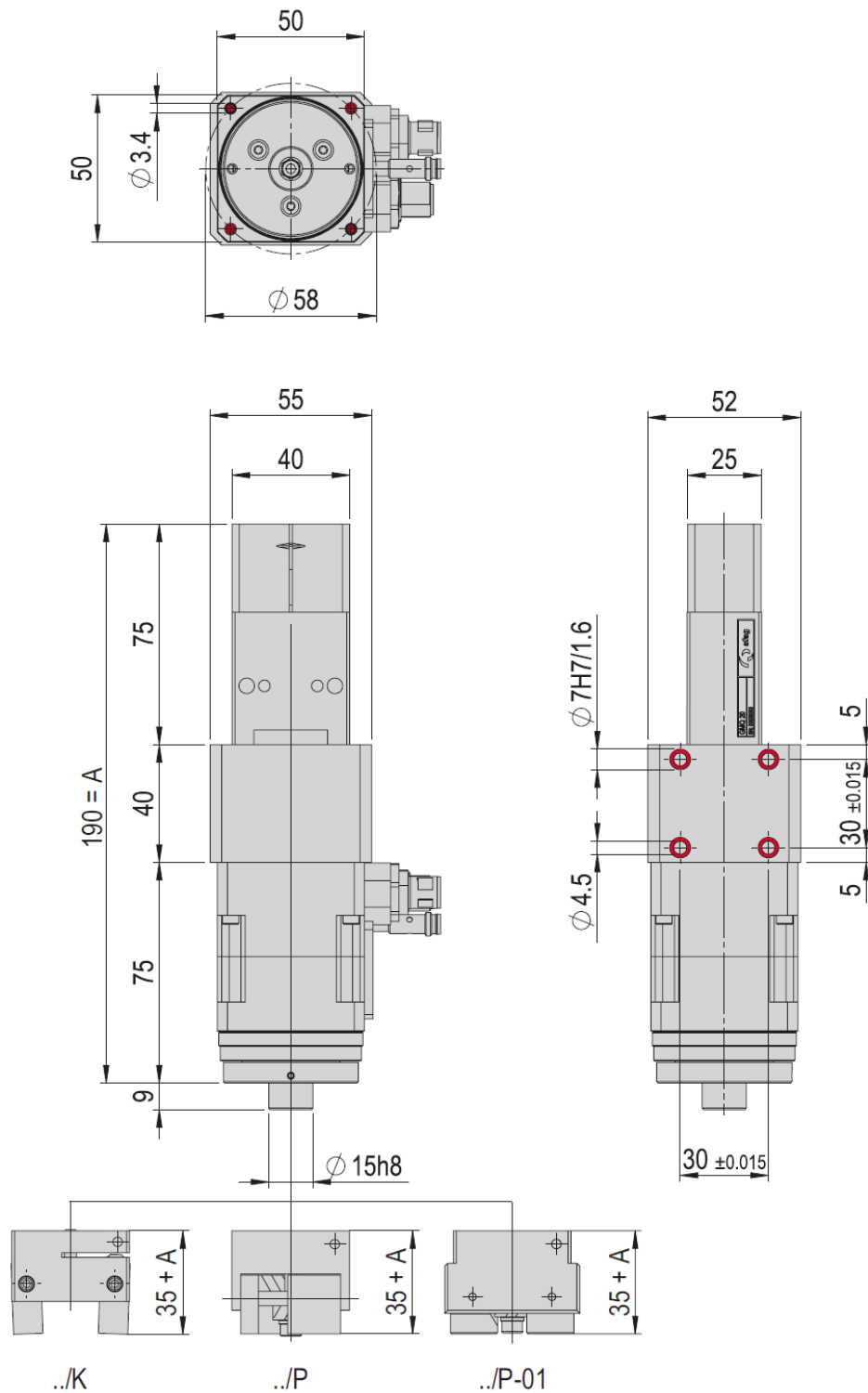

Bores can be screwed through

Fig. 1 Dimensional drawing module GMQ 20

Technical data

3.1.2 Technical data GMQ 20

GMQ 20	
Attachment grid	30 mm
Operating pressure	6 +/- 2 bar
Air connection P	M5
Cylinder Ø	20 mm
Operating temperature	0 - 50 °C

Type	GMQ 20/K	GMQ 20/P	GMQ 20/P-01
Order number	11010477	11010483	50409827
Net weight	0.335 kg	0.411 kg	0.322 kg
Max. admissible weight per gripper finger	60 g	80 g	80 g
Air consumption/cycle	0.021 NL	0.021 NL	0.021 NL
Gripping time	*0.16 s	*0.11 s	*0.11 s
Gripping force	*57 N	*40 N	*60 N
Spring force	17-70 N	17-70 N	17-70 N
Opening angle	180 °	-	-
Opening stroke	-	10 mm	10 mm
Repeat accuracy	+/- 0.02 mm	+/- 0.02 mm	+/- 0.01 mm
Mounting position	✦	✦	✦

The technical data refer to a nominal pressure of 6 bar under Afag standard test conditions.

Note: It must be ensured that the jaw movement is carried out without impact or bouncing. This can be done via the corresponding throttling. Otherwise, the service life will be reduced.

The module can be operated with lubricated or dry air.
Cleanroom class ISO 14644-1, class ISO 7

*Observe gripping force diagrams
- Measurements for slowly closing fingers
- All module measurements carried out via outer clamping.

Included in the delivery (Catalogue HT accessories)

- 2x Centering pin Ø4x6
- 4x Mounting screw M5x35
- 2x Washer M5

Accessories

(Catalogue HT accessories)

- Stop screw AS 08/15
- Adjusting stop pin M8x1/25
- Shock absorber SD M8x1 -2
- INI d6.5x35-Sn1.5-PNP-NO-M8x1
- INI d6.5x44-Sn1.5-PNP-NO-M8x1

3.1.3 Preferred combinations

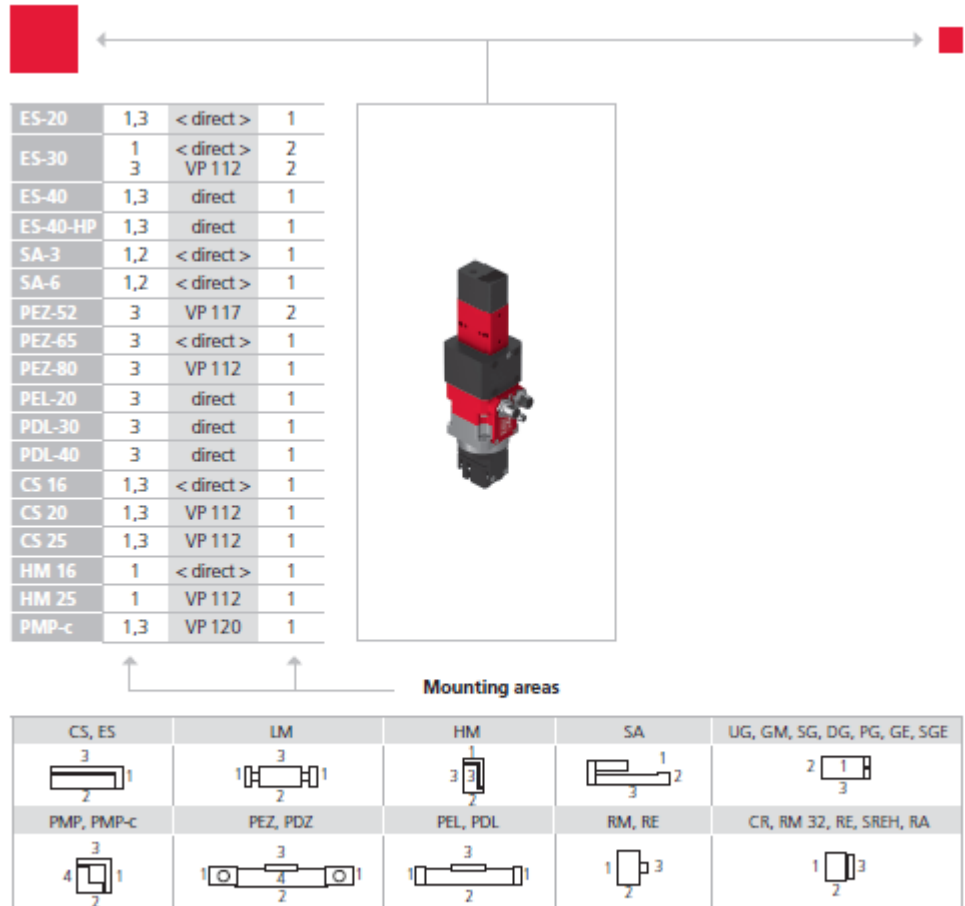

Note that there might be different mounting positions from one module to another one.

The required connection elements and the range of support columns are depicted in the catalogue HT accessories.

3.1.4 Diagrams gripping force GMQ 20

Gripping force diagrams per jaw

GMQ 20/K centric gripping force

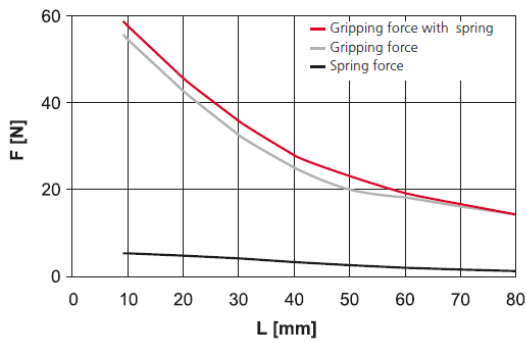

GMQ 20/P eccentric spring force

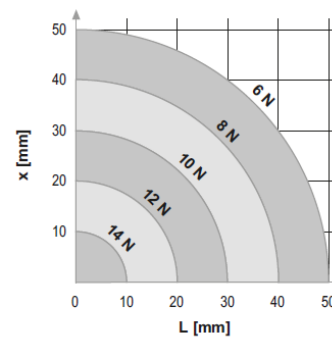

GMQ 20/P eccentric gripping force

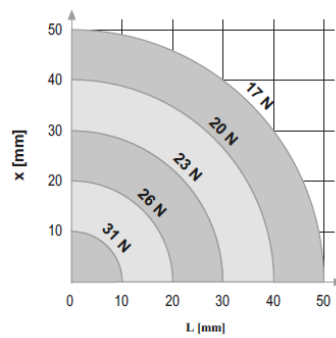

GMQ 20/P eccentric gripping force with gripping force securing

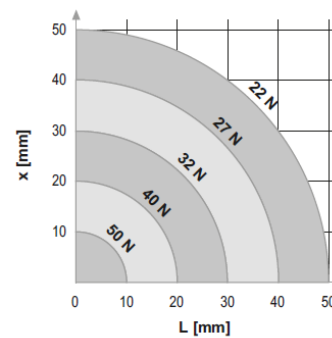

GMQ 20/P centric gripping force

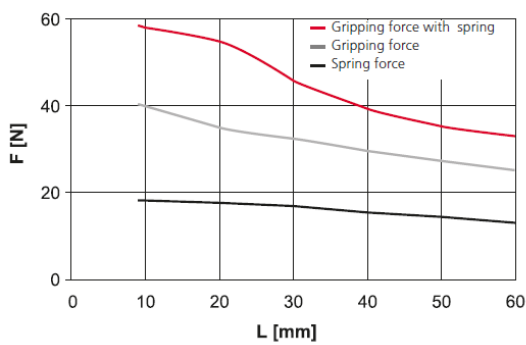

GMQ 20/P-01 centric gripping force

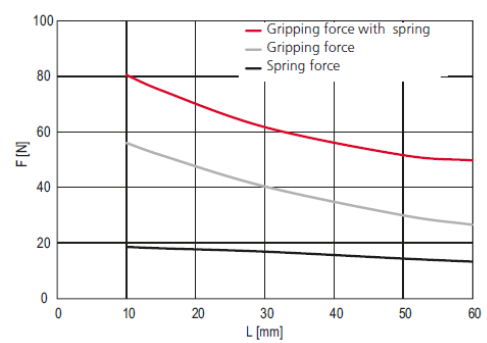

3.2 Rotary module RE-50 (without flange)

3.2.1 Dimensional drawing RE-50

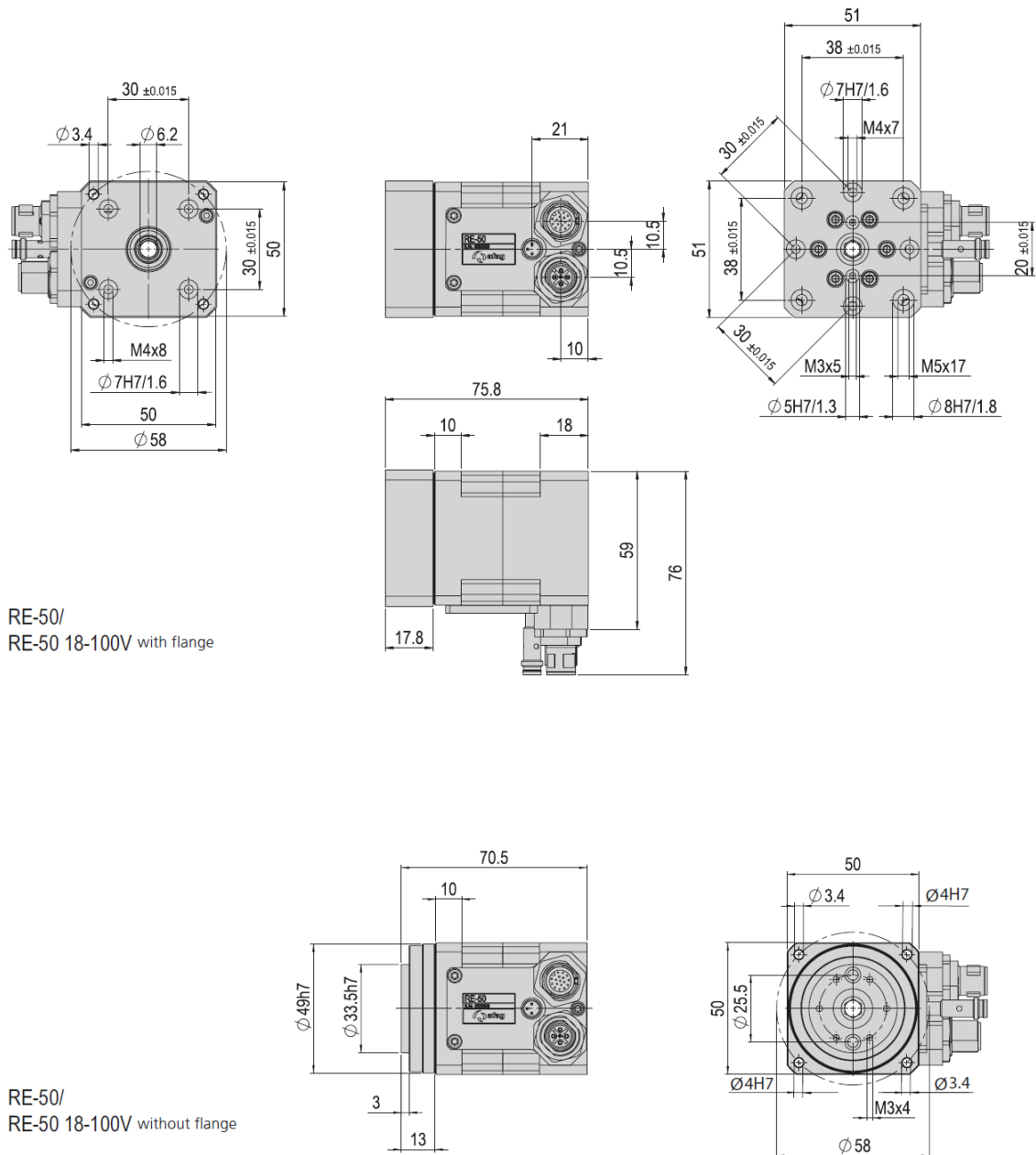

Fig. 2 Dimensional drawing of rotary module RE-50

Technical data

3.2.2 Technical data RE-50

RE-50	
Attachment grid rear	30 x 30 mm
Attachment grid rear LK Ø	58 mm
Attachment grid, front	30 x 30 mm
Attachment grid, front, alternative	38 x 38 mm
Operating temperature	0 - 40 °C
Storage temperature	0 - 50 °C

Type	RE-50	RE-50 without flange	RE-50 18-100V	RE-50 18-100V without flange
Order number	50285554	50294005	50328767	50328768
Net weight	0.575 kg	0.502 kg	0.575 kg	0.502 kg
Max. payload, radial	*0 - 800 N	*0 - 800 N	*0 - 800 N	*0 - 800 N
Max. payload, axial	*0 - 200 N	*0 - 200 N	*0 - 200 N	*0 - 200 N
Max. rotational speed	*200 rpm	*200 rpm	*/ **200 rpm	*200 rpm
Noise level	< 65 dB (A)	< 65 dB (A)	< 65 dB (A)	< 65 dB (A)
Repeat accuracy	+/- 0.0017 °	+/- 0.0017 °	+/- 0.0017 °	+/- 0.0017 °
Hollow shaft Ø	6.2 mm	6.2 mm	6.2 mm	6.2 mm
Operating voltage	230 V	230 V	18 - 100 V	18 - 100 V
Nominal torque	0.75 Nm	0.75 Nm	0.75 Nm	0.75 Nm
Max. output torque	*1.8 Nm	*1.8 Nm	*1.8 Nm	*1.8 Nm
Max. static tipping torque	93 Nm	93 Nm	93 Nm	93 Nm
Max. dynamic tipping torque	15 Nm	15 Nm	15 Nm	15 Nm
Tipping strength	5.8 Nm/arcmin	5.8 Nm/arcmin	5.8 Nm/arcmin	5.8 Nm/arcmin
Protection type	IP 40	IP 40	IP 40	IP 40
Ratio	i = 30	i = 30	i = 30	i = 30
Nominal speed	117 rpm	117 rpm	117 rpm	117 rpm
Mounting position	✦	✦	✦	✦

The technical data pertains to Afag standard test conditions.
Cleanroom class ISO 14644-1, class ISO 7

*The maximum values listed above depend on the application and must not be combined. In case of doubt, please contact your Afag partner
**With SE-24: 117 rpm

Included in the delivery
(Catalogue HT accessories)

- 2x Centering bushing Ø7x3
- 4x Mounting screw M3x22

Accessories

- Flange plate set RE-50 [p. 223]

3.2.3 Preferred combinations

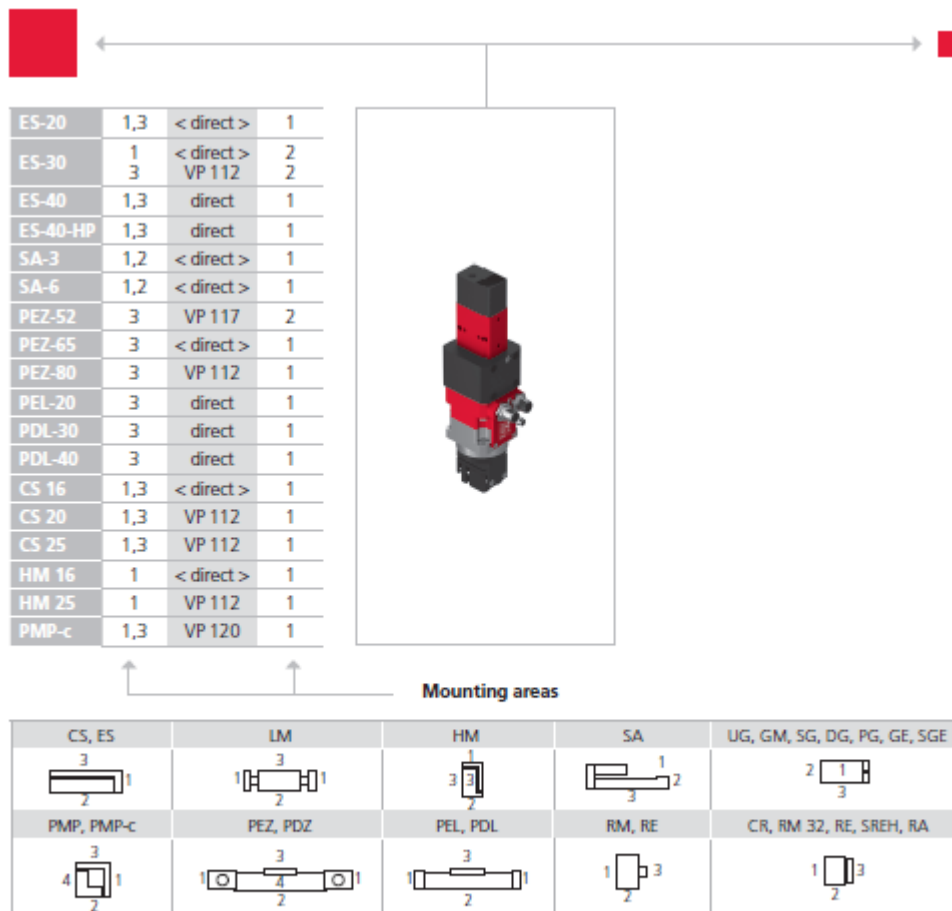

Note that there might be different mounting positions from one module to another one.

The required connection elements and the range of support columns are depicted in the catalogue HT accessories.

3.2.4 Load diagrams RE-50 (without flange)

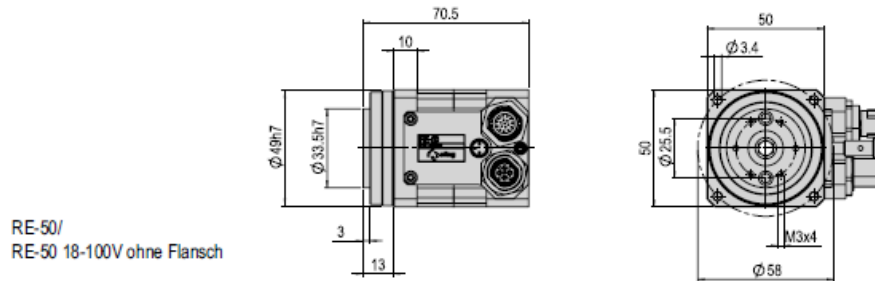

RE-50/
RE-50 18-100V ohne Flansch

Belastungsdiagramme

Schwenkzeit RE-50, 180° - horizontal mit SE-Power

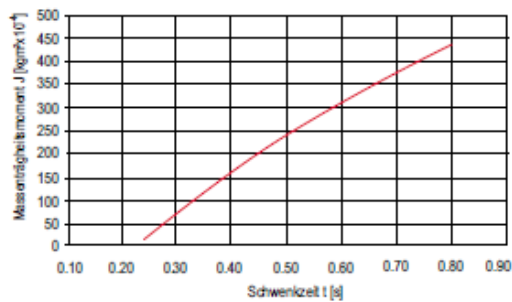

Schwenkzeit RE-50 18-100V, 180° - horizontal mit SE-24

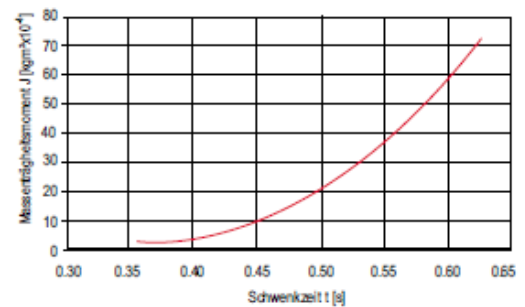

Schwenkzeit RE-50 18-100V, 180° - horizontal mit SE-48

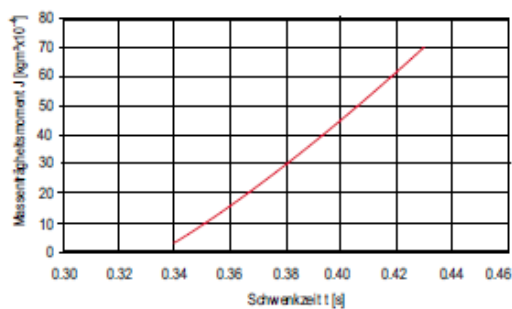

4 Transport, packaging and storage

4.1 Safety instructions



CAUTION

Risk of injury when unpacking the module!

The rotary-gripper modules are packed in the original packaging (cardboard box). If handled incorrectly, the module may fall out of cardboard box when unpacked and cause limb injuries.

- Carefully unpack the module.



Also observe the safety instructions in ↗ chap. 2 „Safety instructions“ in this manual.

4.2 Scope of supply



In addition to the assembly and operating instructions, a safety information sheet is enclosed with each module.

This information sheet must be read by every person who carries out work with and on the module!

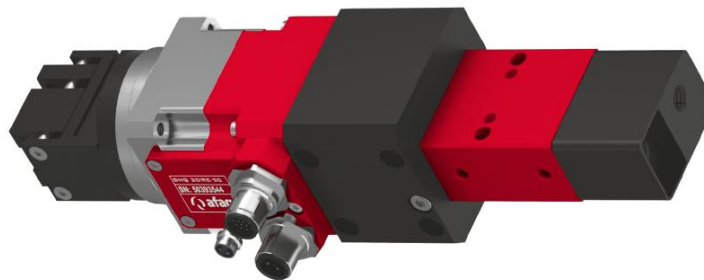

Fig. 3 Scope of supply module GMQ 20/RE-50

[Unt]	GMQ 20	RE-50
1 x	Rotary module (weight < 1 kg)	Rotary module (weight < 2 kg)
2 x	Centering bushing \varnothing 7x3 mm	Centering bushing \varnothing 9x4 mm
2 x	Fastening screws M3x22 mm	Fastening screws M4x30 mm
1 x	Assembly & operat. instructions	Assembly & operating instructions

4.3 Transport



No liability can be assumed for damages caused by improper installation on the part of the operating company.



The following conditions must be complied with for transport and storage:

- Storage temperature: 0-50 °C
 - Relative air humidity: < 90%, non condensing
-

4.4 Packaging

The module is transported in the Afag Automation AG transport packaging. If no Afag packaging is used, the module must be packed in such a way that it is protected against shocks and dust.

NOTICE

Risk to the environment due to incorrect disposal of the packaging material

Environmental damage can be caused by incorrect disposal of the packaging material.

- Dispose of the packaging material in an environmentally sensitive way in accordance with the local environmental regulations.
-

4.5 Storage

Observe the following points when storing the modules for a longer period:

- Store the modules in the transport packaging.
- Do not store the module outdoors or expose it to weather conditions.
- The storage space must be dry and dust free.
- Room temperature of the storage space: 0-50 °C.
- Relative air humidity: < 90% non condensing.
- Clean modules and protect the blank metal parts against corrosion using the appropriate means.
- Protect the modules from dirt and dust.

5 Design and description

5.1 Design rotary-gripper module GMQ 20/RE-50

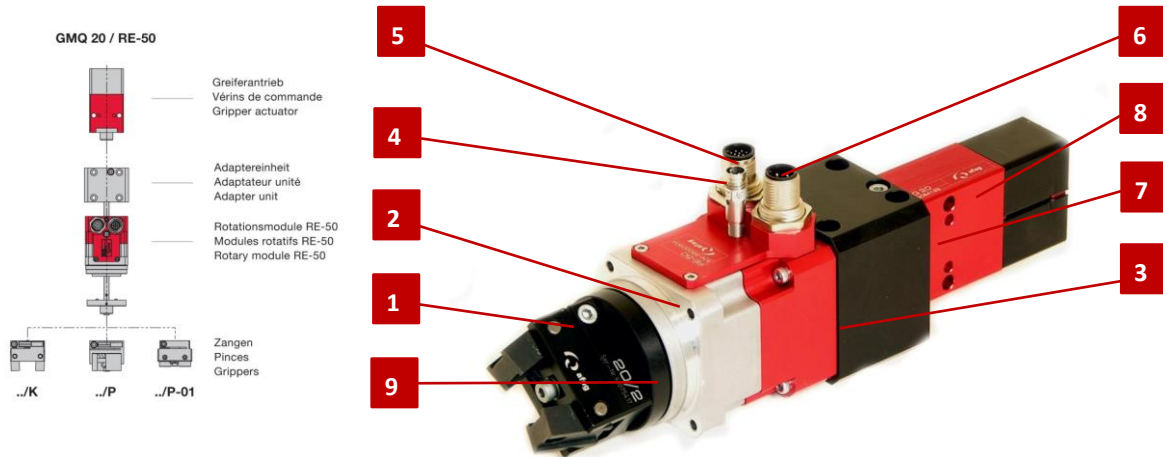
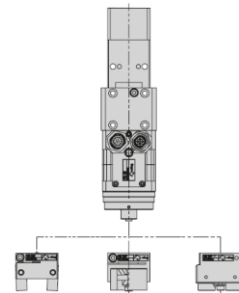

Fig. 4 Rotary-gripper module (pneumatic-electric)

- | | |
|-----------------------------|----------------------|
| 1. Gripping jaws | 6. Motor connection |
| 2. Servo drive with gearbox | 7. Adapter unit |
| 3. Encoder housing | 8. Air connections |
| 4. Proximity switch | 9. Connecting flange |
| 5. Encoder connection | |

GMQ 20/RE-50



Grippers	..K	..P	..P-01
GMQ 20/.. / RE-50 18-100V	50355549	50355547	50410327
Net weight	1.141 kg	1.148 kg	1.194 kg
GMQ 20/.. / RE-50	50355546	50355544	50410326
Net weight	1.141 kg	1.148 kg	1.194 kg

5.2 Product description

The GMQ 20/RE-50 module is a highly compact pneumatic-electric rotary module for rotating and gripping payloads. The rotary modules are equipped with a 17-pin industrial connector (G13) and a 4-pin M15 connector. The rotary modules are designed for operation with the Afag controllers SE-Power 1kVA, SE-48 and SE-24. The modules can also be operated with other third-party controllers.

Further technical information can be found in the chapter 3 Technical data in these installation instructions.

5.3 Accessories

Cr.	Designation	Order Number
1	Centring sleeve 7x3mm	11016850
2	Centring sleeves 9x4mm	11004942
3	Flange plate set RE-50	50294008
4	Flange plate set RE-50	50294009
5	Motor cable-M12-5m-0-open (SE-Power)	50290459
6	Motor cable-M12-10m-0-open (SE-Power)	50310506
7	Motor cable-M12-5m-90-open (SE-Power)	50290460
8	Motor cable-M12-10m-90-open (SE-Power)	50310507
9	Motor cable-M15-3m-0-0 (SE24/48)	50332418
10	Motor cable-M15-3m-0-0 (SE24/48)	50332420
11	Motor cable-M15-5m-0-0 (SE24/48)	50338977
12	Motor cable-M15-5m-90-0 (SE24/48)	50338978
13	Encoder cable-G10-5m-0-0 (SE-Power)	50297199
14	Encoder cable-G10-10m-0-0 (SE-Power)	50310508
15	Encoder cable-G10-5m-90-0 (SE-Power)	50297200
16	Encoder cable-G10-10m-90-0 (SE-Power)	50310509
17	Encoder cable-G10-5m-0-open	50290461
18	Encoder cable-G10-10m-0-open	50310511
19	Encoder cable-G10-5m-90-open	50290462
20	Encoder cable-G10-10m-90-open	50310512
21	Encoder cable-G12-3m-0-0 (SE24/48)	50332416
22	Encoder cable-G12-3m-0-0 (SE24/48)	50332417
23	Encoder cable-G12-5m-0-0 (SE24/48)	50338975
24	Encoder cable-G-12-5m-0-0 (SE24/48)	50338976
25	Proximity switch cable-R1-5m-0-open (SE-Power)	11006446
26	Proximity switch cable-R1-10m-0-open (SE-Power)	50072072
27	Proximity switch cable-R1-5m-90-open (SE-Power)	11007826
28	Proximity switch cable-R1-10m-90-open (SE-Power)	50310513
29	Proximity switch cable-R2-3m-0-0 (SE-24/SE-48)	50340271
30	Proximity switch cable-R2-5m-0-0 (SE-24/SE-48)	11017754
31	Proximity switch cable-R2-3m-90-0 (SE24/SE-48)	50340272
32	Proximity switch cable-R2-5m-90-0 (SE24/SE-48)	50340903
33	Controller SE-24	-
34	Controller SE-48	-
35	Controller SE-Power 1 kVA	-
36	Sensor INI d8x36-SN2.0-PNP-NCM8x1	50285525
37	Mounting wrench for RE-50	50355913

6 Installation, assembly and setting

The rotary-gripper module is an incomplete machine. For safe operation, the module must be integrated into the safety concept of the system in which it is installed.

During normal operation, it must be ensured that the user cannot interfere with the working area of the module. This can be achieved through suitable protective measures (e.g. enclosure, light grid).

When the system is running in special operating modes, it must be ensured that there is no danger to the operator.



The system operator is responsible for the installation of the rotary-gripper modules in a system!

6.1 Safety instructions

CAUTION



Personal injury caused by hot surfaces!

High surface temperatures (up to 80°C) can occur on the module. There is a risk of injury and damage to property.

- No temperature-sensitive parts such as cables or electronic components may be in contact with or attached to the module!
- Before touching hot surfaces without protective gloves, make sure they have cooled down to ambient temperature.

CAUTION



Risk of injuries due to uncontrolled parts movements!

When connecting to the control system and during operation of the modules, unpredictable movements may occur and cause injury/property damage.

- Before working on the rotary-gripper module, make sure that the control unit is switched off and secured against being switched on again.

CAUTION



Risk of injury due to mounted components!

Attachments on the module can be a risk in conjunction with moving parts.

- Take appropriate measures to ensure safe operation!



Also observe the safety instructions in  chap. 2 „Safety instructions“ in this manual.

6.2 Assembly & attachment

The rotary-gripper module can be mounted both in horizontal and vertical position.

6.2.1 Fastening the module

The fastening is performed to the black intermediate part in a 30x30 mm grid by means of 4 x M4 screws.

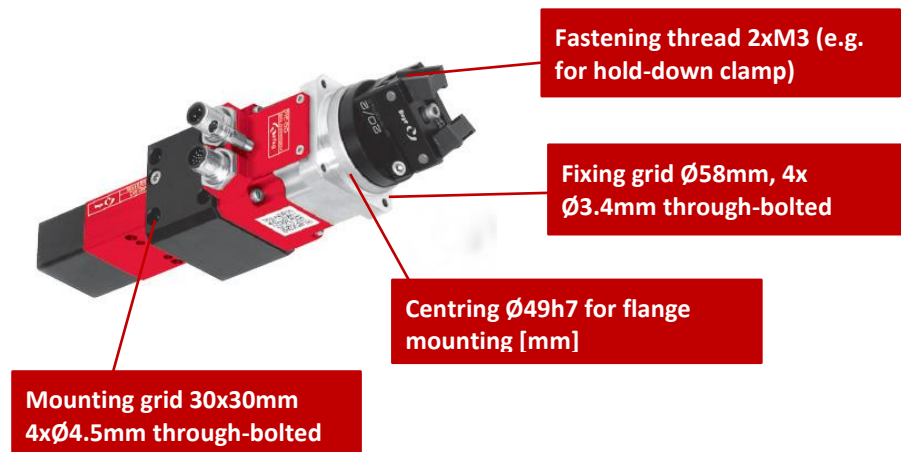

Fig. 5 Fastening the gripper-rotary modules



For positioning use the centring sleeves included in the supply. Insert the centering sleeves into two diagonally opposite holes of the attachment grid.

6.2.2 Tightening torques

For assembling use screws with the following minimum specifications:

Standard	VDI 2230
Screw strength	Category 8.8
Surface:	Galvanized blue, oiled or greased

Thread	Tightening torque
M2	0.3 ... 0.35 Nm
M2.5	0.5 ... 0.73 Nm
M3	1.1 ... 1.4 Nm
M4	2.6 ... 3.3 Nm
M5	5.2 ... 6.5 Nm
M6	9.0 ... 11.3 Nm
M8	21.6 ... 27.3 Nm

Centering bushings	Ø4x2	Ø5x2.5	Ø7x3	Ø8x3.5	Ø9x4	Ø12x4.8	Ø19x5.8
Order number	50332257	50035831	11016850	50263565	11004942	50187424	50189497
Net weight	0.001 kg	0.001 kg	0.001 kg	0.001 kg	0.001 kg	0.002 kg	0.006 kg
A	4 mm	5 mm	7 mm	8 mm	9 mm	12 mm	19 mm
B	2 mm	2.5 mm	3 mm	3.5 mm	4 mm	4.8 mm	5.8 mm
C	2.6 mm	3.2 mm	4.3 mm	5.4 mm	6.5 mm	8.5 mm	13 mm

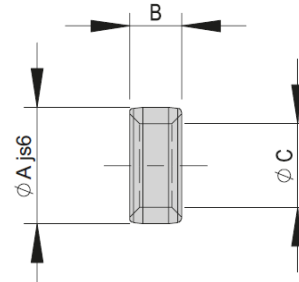

Attachment grid	16x16 mm	20x20 mm	30x30 mm	38x38 mm	48x48 mm	60x60 mm	75x75 mm	96x96 mm
A	16 mm	20 mm	30 mm	38 mm	48 mm	60 mm	75 mm	96 mm
B	8 mm	10 mm	15 mm	19 mm	24 mm	30 mm	38 mm	48 mm
C	4x1.1 mm	5x1.3 mm	7x1.6 mm	8x1.8 mm	9x2.1 mm	12x2.5 mm	15x2.7 mm	19x3 mm
D	M2.5	M3	M4	M5	M6	M8	M10	M12

Module-centering, centering bushings

In order to guarantee a high and repetitive fit accuracy during installation, operation or replacement of a module, all components of the entire program are consequently provided with a precise module centering. Centering bushings or pins are supplied as standard with each module.

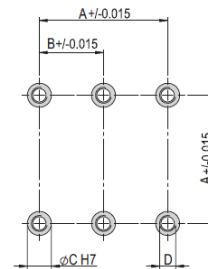

6.2.3 Electrical interfaces

Motor cable (M12 or M15)

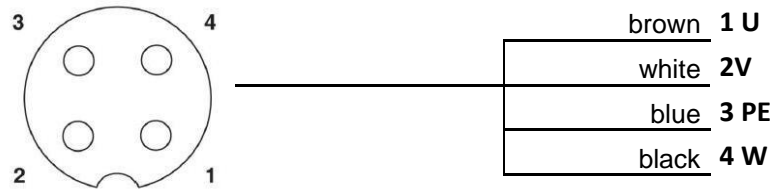

Encoder cable (G10 or G12)

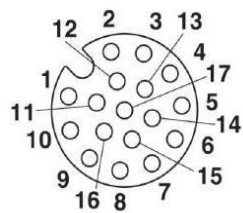

1	U
2	V
3	B/
4	A
5	W/
6	Z
7	GND
8	B
9	+ 5 V
10	V/
11	W
12	Z/
13	A/
14	U/
15	n.a.
16	n.a.
17	n.a.

Sensor plug (M5x0.5)

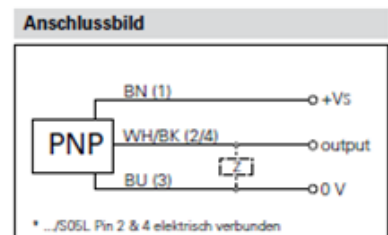
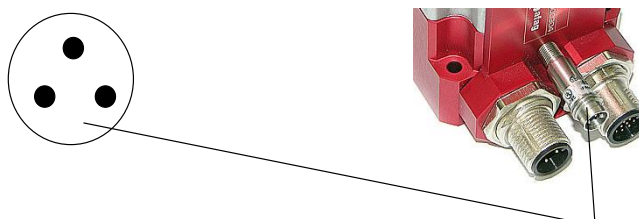

6.3 Gripping jaws

If the GMQ 20/RE-50 module was ordered without tongs, the tongs can be reordered.

The GMQ 20 gripper drive can be equipped with the normal gripping jaws of the GMQ 20 pneumatic gripper. There are 4 types to choose.

GMQ 20 /.. / RE-50	50355546	50355544	50410326
GMQ 20 /.. / RE-50 : 18-100 V	50355549	50355547	50410327
	..K	..P	..P-01

Wählen Sie Ihre Greifzange aus
 Sélectionnez vos pinces
 Select your grippers

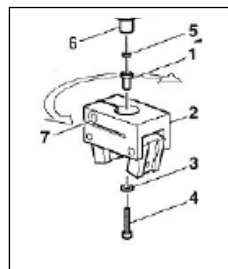

1. Centering bushing
2. Gripping jaws
3. Washer
4. Fastening screw
5. Centring ring
6. Drawbar
7. Clamping screw

6.3.1 Assembly of gripping jaws



The drawbar on the gripping drive must be extended to mount the gripping jaws!

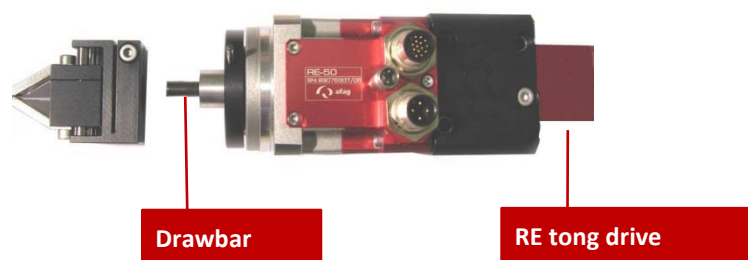

Proceed as follows to assemble the gripper:



1. Insert centring ring (5) and centring sleeve (2).
 2. Insert (lock) the cylindrical pin into the flange.
 3. Dismount the gripping jaws (2).
 4. Tighten the screw (4).
 5. Align the gripping jaws.
 6. Fasten clamping screw (7).
- ⇒ The assembly of the gripping jaws is completed.

6.3.2 Dismounting the gripping jaws



The drawbar on the gripping drive must be extended to mount the gripping jaws!

Required tools:

	GMQ 20/K	Socket wrench key width 5.5
	GMQ 20/P	Socket wrench key width 5.5
	GMQ 20/P-01	Allan key size 2.5

To dismount of the gripping jaws, proceed as follows:

1. The gripping jaws must be completely opened.
2. Insert the straight pin into the flange hole so that the gripping jaws is locked in place.
3. Loosen the screw with the hexagonal screwdriver.

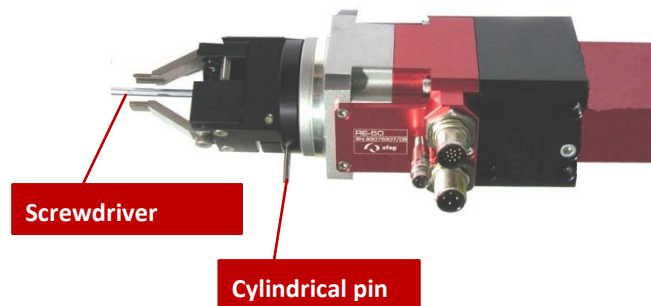

4. Loosen the clamping screw on the gripping jaws:
 - Gripping jaws can be extracted.



⇒ The disassembly is completed.

6.3.3 Manufacture of the gripper fingers

The gripping fingers are not included in the scope of delivery. The preparation of the gripping fingers is the responsibility of the system operator.

The jaws of the grippers are provided with a standard fit (**12 G8**).

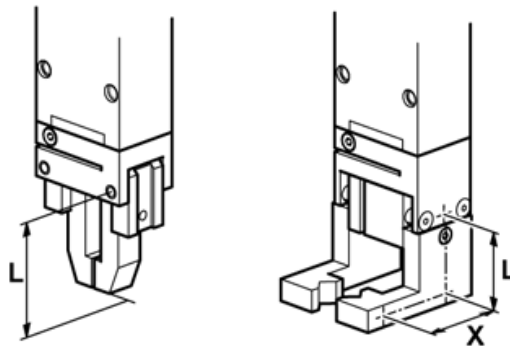

The drawings of the gripping jaws can be found in the AFAG technical catalogue!

7 Commissioning

After connection, the GMQ-modules are put into operation for the first time via the system controller.



Commissioning must only be carried out in setup/jog mode.

7.1 Safety instructions



DANGER

Risk of injury due to electric shock!

Unauthorized removal of the plug cover causes a risk of electric shock!

- Do NOT dismount the plug cover!
- Avoid any action on the module which could endanger safety!



CAUTION

Danger of injury in the working area of the rotary modules!

Due to the decentralised controller, the operator of the module must not necessarily stand next to the module during operation so that he may not have a complete view of the working area. Persons in the working area may be injured.

- During operation, ensure a good overview of the working area.
- Unauthorised persons are not allowed in the work area.



CAUTION

Risk of injuries due to uncontrolled parts movements!

When the controller is switched on, signals from the controller can lead to unintentional movements of the module and cause serious injuries or damage to property.

- Before working on the module, make sure that the controller is switched off and secured against being switched on again.
- Only connect or disconnect the cables when the control unit is switched off.



CAUTION

Risk of injury due to mounted components!

Attachments on the module can be a risk in conjunction with moving parts.

- Take appropriate measures to ensure safe operation!



When carrying out set-up work on the module, the controller enable must be deactivated and only switched on again after the work has been completed!



Also observe the safety instructions in ↷ chap. 2 „Safety instructions“ in this manual.

Please also observe the installation instructions for the control unit used!

7.2 Preparatory activities for commissioning

The rotary module is designed for operation with AFAG - servo controller. The modules can also be operated with other control systems.

The operation of the AFAG servo controller is described in the separate installation instructions for the respective servo controller.

Perform a test run in preparation for commissioning. To turn de connectors, proceed as follows:

1. Connect the servo controller to the computer (operating software must be installed).
 - The use of the operating software is described in the installation instructions for the servo controller used.
2. If the rotary-gripper module is supplied with an Afag servo controller, no further action is required (operating parameters already stored in the controller).
3. When using a different servo controller, special cables must be made and the operating parameters determined.
 - ⇒ The test operation can now be carried out.

7.3 Commissioning of the modules

Proceed carefully and follow the instructions step by step when commissioning the modules for the first time:

1. Observe the permissible technical values (↷ Chapter 3).
 - Payload
 - Movement frequency
 - Momentary load
2. First, make sure that there are no persons or tools in the working area.
3. Perform test run:
 - Start with slow movements.
 - Then continue under normal operating conditions.
 - ⇒ Commissioning is completed.

7.4 Setting-up and retrofitting

Adjusting the cable connection position

The position of the cable connections is freely selectable. In the standard delivery of the module, the cable connections point to the front.

If necessary, the black mounting part of the module can be rotated so that the cable connection on the module is on the left or right side.

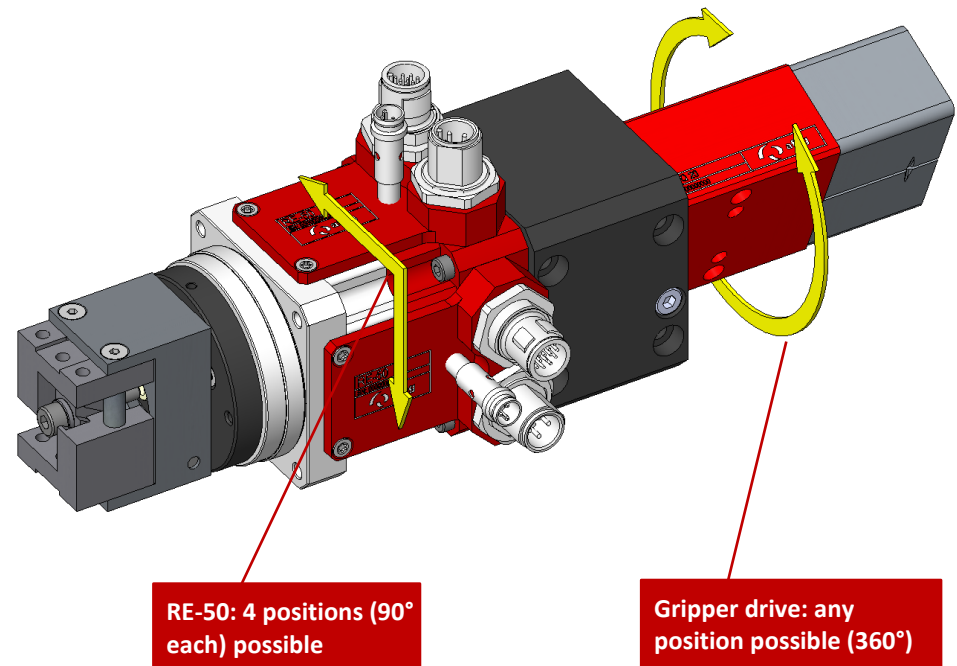

Fig. 6 Adjustment options for cable connections

Procedure: Change the position of the cable connections

1. Loosen four screws on the RE-50 module with the 2.5 mm hexagonal screwdriver.



2. Remove the module RE-50, then turn it to the desired side and mount it again.



3. Screw the RE-50 module back into the new position.

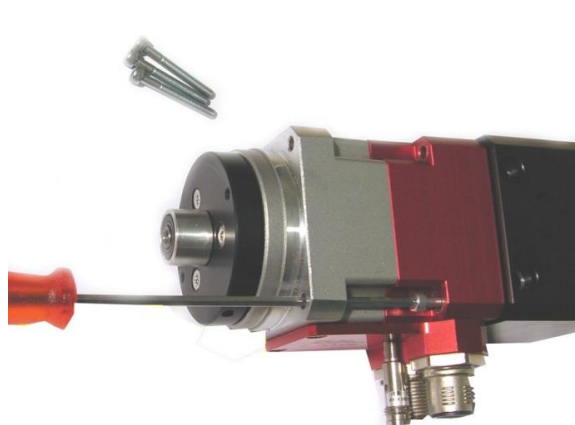

⇒ The process is complete.

8 Fault elimination

8.1 Safety instructions



DANGER

Risk of injury due to electric shock!

Unauthorized removal of the plug cover causes a risk of electric shock!

- Do NOT dismount the plug cover!
 - Avoid any action on the module which could endanger safety!
-



WARNING

Danger of injury due to faulty troubleshooting!

Poorly performed troubleshooting work can lead to serious injuries and damage to property.

- Only use trained specialist personnel for troubleshooting.
 - All work on the modules must be carried out with the power supply cut off!
-



WARNING

Risk of injuries due to uncontrolled parts movements!

Signals from the controller can trigger unintentional movements of the module, which can cause injury.

- Before starting any work on the module, switch off the controller and secure to prevent it from being switched on.
 - Observe the operating instructions of the controller used!
-



Also observe the safety instructions in ➔ chap. 2 „Safety instructions“ in this manual.

8.2 Fault causes and remedy

The following table contains an overview of possible fault causes and how to proceed to eliminate them.

Fault	Possible cause	Remedy:
Rotary shaft (gripper) oscillates (very strong vibrations at the drive)	<ul style="list-style-type: none"> ▪ Too large mass moments of inertia of the elements/payload on the rotating flange 	<ul style="list-style-type: none"> ▪ Reduce mass moment of inertia (details according to technical data)
Rotary shaft (gripping jaws) continues to rotate without interruption (stop not mounted)	<ul style="list-style-type: none"> ▪ Controller parameters set incorrectly ▪ End position sensor incorrectly connected ▪ Interruption in the connection of the end position sensor ▪ End position sensor defective 	<ul style="list-style-type: none"> ▪ Readjust the parameters on the controller ▪ Check pin assignment; correct if necessary ▪ Check end position sensor cable ▪ Replace end position sensor (only by Afag service technician - see below!)
Rotating shaft (gripping jaws) rotates to the wrong side of the optional stop and stands still	<ul style="list-style-type: none"> ▪ Incorrect homing (reference) direction ▪ Drive incorrectly connected 	<ul style="list-style-type: none"> ▪ Check the reference travel direction, change if necessary ▪ Check pin assignment, correct if necessary
Rotary shaft (gripping jaws) does not move	<ul style="list-style-type: none"> ▪ Drive incorrectly connected ▪ Motor disconnection ▪ Drive defective 	<ul style="list-style-type: none"> ▪ Check pin assignment, correct if necessary ▪ Check motor cable ▪ Replace drive (only by Afag service technicians!)
Rotary shaft (gripping jaws) stops after a short rotation	<ul style="list-style-type: none"> ▪ Significant contouring error ▪ Interruption in the encoder connection 	<ul style="list-style-type: none"> ▪ Reduce values for acceleration and speed ▪ Check if the module shaft is mechanically blocked ▪ Check encoder cable ▪ Check functioning of encoder

9 Maintenance and repair

9.1 General notes

The rotary-gripper modules are almost maintenance-free. Nevertheless, some maintenance work must be carried out to ensure an optimum operating condition of the modules.

9.2 Safety instructions



DANGER

Risk of injury due to electric shock!

Unauthorized removal of the plug cover causes a risk of electric shock!

- Do NOT dismount the plug cover!
 - Avoid any action on the module which could endanger safety!
-



WARNING

Danger of injury due to improper maintenance!

Improperly carried out maintenance activities can cause considerable damage to property and serious injury.

- Only use trained specialist personnel to carry out the activities.
 - Always wear personal protective equipment when carrying out maintenance and repair work!
-



WARNING

Risk of injuries due to uncontrolled parts movements!

Signals from the controller can trigger unintentional movements of the module, which can cause injury.

- Before starting any work on the module, switch off the controller and secure to prevent it from being switched on.
 - Observe the operating instructions of the controller used!
-



Also observe the safety instructions in ➔ chap. 2 „Safety instructions“ in this manual.

9.3 Maintenance activities and maintenance intervals



- The maintenance intervals must be strictly observed. The intervals refer to a normal operating environment.

9.3.1 Overview of the maintenance points

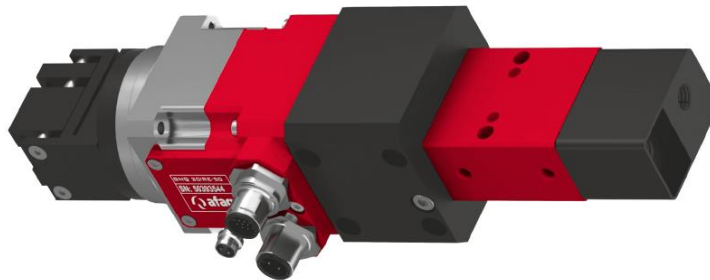



Fig. 7 Maintenance points of the module

No.	Maintenance point	Maintenance work	Interval	System [On/Off]	Remarks
1	Module	Cleaning and checking 	As required	[Off]	-

NOTICE

Risk of damage to property!

The servo grippers can be damaged by incorrectly adjusted, missing or defective shock absorbers.

- We recommend replacing the shock absorbers after max. 5 million load cycles

9.3.2 Further maintenance

Further maintenance is not required, if the ambient conditions listed below are complied with:

- Clean working area.
- No use of splash water.
- No abrasion or process dusts.
- Environmental conditions as specified in the technical data.

9.4 Repair and overhaul

9.4.1 Replacing the GMQ 20 gripper drive

If a gripper drive fails or is defective after the warranty period, it can be replaced by the system operator as described below.



A special tool (assembly spanner combination) is required to replace the gripper drive and must be ordered separately!

Product	Order Number
Gripper drive GMQ 20	11009173
Assembly key	50355913 (for RE-50)



If the gripper drive is replaced by the system operator within the warranty period, the warranty claim expires.

Proceed as follows to replace the gripper drive GMQ 20:

1. Loosen and remove four cap screws on the RE-50 module.



2. Remove the RE-50 module.



3. Insert the assembly key.

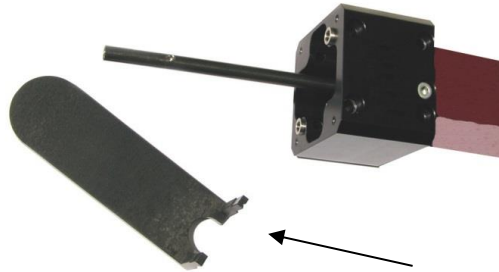

4. Use the assembly key to loosen the pivot bearing so that the pivot bearing can be removed together with the drawbar.

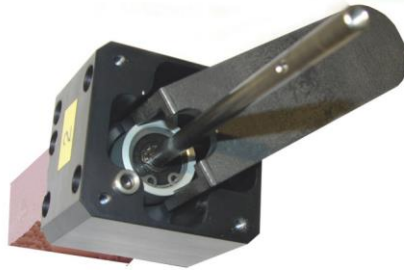

5. Loosen the clamping screw on the middle section.

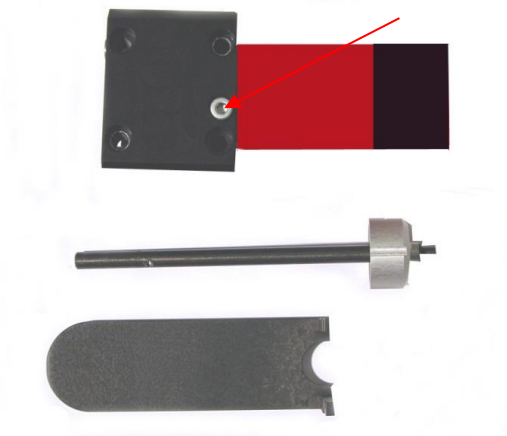

6. Remove the gripper drive.

⇒ The disassembly of the gripper drive is completed.

9.4.2 Replacing the RE-50 rotary module

If a gripper drive fails or is defective after the warranty period, it can be replaced by the system operator as described below.

Product	Order Number
RE-50	50294005
RE-50 (18-100V)	50328768



If the rotary module is replaced by the system operator within the warranty period, the warranty claim expires.

Proceed as follows to replace the rotary module RE-50:

1. Loosen and remove four cap screws (M3) on the RE-50 module.



2. Remove the defective RE-50 module.



3. Mount the new RE-50 module on the diagonal centring sleeves on the intermediate part of the module.
 - Note the cable connections on the new rotary module!



⇒ The RE-50 module has been replaced.

9.4.3 Replace end position sensor



The end position sensor may only be replaced by the manufacturer.

The manufacturer does not accept any warranty for sensors that have been replaced by the customer himself!

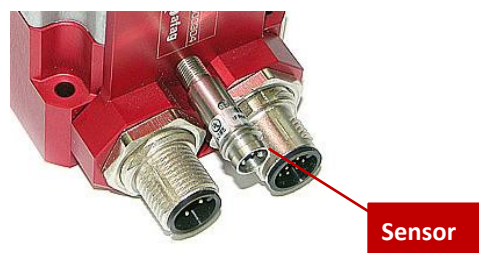

9.5 Spare parts and repair work

Afag Automation AG offers a reliable repair service. Defective modules can be sent to AFAG for warranty repair within the warranty period.



Damaged rotary-gripper modules may only be replaced or repaired by Afag Automation AFAG!

WARNING



Danger of injury in case of improper dismantling!

Improperly carried out activities can result in considerable material damage and serious injury.

- Disconnect the media supply (electrics, pneumatics) before removing the modules!
 - Only remove module when the controller is switched off and secured!
-



The manufacturer does not provide any warranty for work on the module carried out by the system operator after the warranty period has expired.

Repairs will be charged!

10 Decommissioning, disassembly, disposal

The rotary-gripper modules must be properly dismantled after use and disposed of in an environmentally friendly manner.

10.1 Safety instructions

WARNING



Danger of injury due to improperly performed activities!

Improperly carried out activities can result in considerable material damage and serious injury.

- Only use trained specialist personnel to carry out the activities.
 - Disconnect the media supply (electrics, pneumatics) before removing modules!
 - Only remove module when the controller is switched off and secured!
-

10.2 Decommissioning

If the rotary-gripper modules are not used for a longer period, they must be properly commissioned and stored as described in ➔ chapter 4.5.

10.3 Disposal

The rotary-gripper module must be disposed of properly at the end of their service life and the raw materials used must be recycled. Observe the legal regulations and company requirements.

The rotary-gripper modules must not be disposed of as a complete unit. Dismantle the controller into individual parts and separate the various components according to type of material and dispose of them properly:

- Scrap the metallic materials.
- Hand over plastic parts for recycling.
- Sort the rest of the components by their material properties and dispose of them accordingly.

NOTICE

Risk to the environment due to incorrect disposal of the rotary modules!

Environmental damage can be caused by incorrect disposal of the packaging material.

- Electronic parts, electrical scrap, auxiliary and operating materials must be disposed of by approved specialist companies.
 - Information on proper disposal can be obtained from the responsible local authorities.
-

Declaration of incorporation

11 Declaration of incorporation

Declaration of incorporation

for partly completed machinery according to the Machinery Directive 2006/42/EC, Annex II, 1.B

The manufacturer hereby declares:

Afag Automation AG, Luzernstrasse 32, CH-6144 Zell

that the partly completed machine:

Product description	Gripper-rotary module GMQ (pneumatic/electric)
Type:	GMQ 20 / RE-50, GMQ 20 / RE-50 (18-100 V)

complies with the following essential health and safety requirements of the Machinery Directive 2006/42/EC at the time of declaration: 1.1; 1.1.1; 1.1.2; 1.2; 1.2.1; 1.2.3; 1.2.4.4; 1.2.5; 1.3; 1.3.3; 1.3.5; 1.3.6; 1.3.7; 1.3.8.1; 1.3.8.2; 1.3.9; 1.4; 1.4.1; 1.5; 1.5.1; 1.6; 1.6.1; 1.6.3; 1.6.4; 1.7; 1.7.1; 1.7.4.; 1.7.4.1; 1.7.4.2; 1.7.4.3; 3.3.5; 3.4.1

Harmonised standards applied, in particular:	
EN ISO 12100:2010	Safety of machinery - General design principles - Risk assessment and risk reduction.

Note: The partly completed machinery must not be put into service until the machinery into which it is to be incorporated has been declared in conformity with the provisions of Machinery Directive 2006/42/EC.

The manufacturer undertakes to transmit, in response to a reasoned request by the national authorities, relevant technical documentation for the partly completed machinery.

The relevant technical documentation was created according to Annex VII, Part B of the above-mentioned Directive .

Authorised representative for compiling the technical documentation:

Niklaus Röthlisberger, Product Manager, Afag Automation AG, CH-6144 Zell

Zell, 31.05.2023

Adrian Fuchser



CEO Afag Gruppe

Klaus Bott



CTO Afag Gruppe

Afag Automation AG
Luzernstrasse 32
6144 Zell
Switzerland
T +41 62 959 86 86
sales@afag.com

Afag GmbH
Werner-von-Braun-Straße 1
92224 Amberg
Germany
T +49 9621 650 27-0
sales@afag.com

Afag Engineering GmbH
Gewerbestraße 11
78739 Hardt
Germany
T +49 7422 560 03-0
sales@afag.com

Afag Automation Americas
Schaeff Machinery & Services LLC.
883 Seven Oaks Blvd, Suite 800
Smyrna, TN 37167
USA
T +1 615 730 7515
nashville@afag.com

Afag Automation APAC
Afag Automation Technology (Shanghai) Co., Ltd.
Room 102, 1/F, Bldg. 56, City Of Elite
No.1000, Jinhai Road, Pudong New District
Shanghai, 201206
China
T +86 021 5895 8065
shanghai@afag.com