

Flexim PIOX R532 Process Refractometer



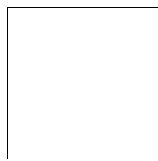

Table of contents

| | | |
|----------|---|----|
| 1 | Introduction | 5 |
| 2 | Safety instructions | 6 |
| 2.1 | General safety instructions | 6 |
| 2.2 | Intended use | 6 |
| 2.3 | Not intended use | 7 |
| 2.4 | Safety instructions for the user | 7 |
| 2.5 | Safety instructions for the operator | 7 |
| 2.6 | Safety instructions for electrical work | 7 |
| 2.7 | Safety instructions for transport | 8 |
| 2.8 | Recommended procedure in hazardous situations | 8 |
| 3 | General principles | 9 |
| 3.1 | Measurement principle | 9 |
| 3.2 | Diagnostic values | 12 |
| 3.3 | Sensor values | 12 |
| 4 | Product description | 13 |
| 4.1 | Handling concept | 13 |
| 4.2 | Display | 15 |
| 4.3 | Keyboard | 16 |
| 5 | Transport and storage | 17 |
| 5.1 | Transport | 17 |
| 5.2 | Storage | 17 |
| 6 | Mounting | 18 |
| 6.1 | Transmitter | 19 |
| 6.2 | Sensor | 23 |
| 7 | Connection | 29 |
| 7.1 | Sensor | 29 |
| 7.2 | Power supply | 33 |
| 7.3 | Outputs | 34 |
| 7.4 | Service interfaces | 37 |
| 8 | Start-up | 39 |
| 8.1 | Start-up settings | 39 |
| 8.2 | Switching on | 40 |
| 8.3 | Language | 40 |
| 8.4 | Initialization | 41 |
| 8.5 | Date and time | 41 |
| 8.6 | Information regarding the transmitter | 41 |
| 9 | Measurement | 42 |
| 9.1 | Parameter input | 42 |
| 9.2 | Measurement settings | 45 |
| 9.3 | Units of measurement | 46 |
| 9.4 | Start of measurement | 46 |
| 9.5 | Display during the measurement | 46 |
| 9.6 | Stop of measurement | 48 |

10 Troubleshooting 49

10.1 Problems with the measurement 50

10.2 Measuring point selection 50

10.3 Application-specific problems 50

11 Maintenance and cleaning 51

11.1 Maintenance 51

11.2 Cleaning 52

12 Dismounting and disposal 53

12.1 Dismounting 53

12.2 Disposal 53

13 Outputs 54

13.1 Analog output 54

13.2 Digital output 60

14 Data logger 69

14.1 Configuration of the data logger 69

14.2 Deletion of the data logger 72

14.3 Information regarding the data logger 73

15 Data transmission 74

15.1 Service interfaces 74

15.2 Process interface 75

16 Event trigger 76

16.1 Apparent switching delay 79

16.2 Reset and initialization of the event trigger 79

16.3 Event trigger during the measurement 79

16.4 Status display of the event trigger 80

16.5 Event log 80

17 Calibration 81

18 Settings 82

18.1 Dialogs and menus 82

18.2 Working with parameter sets 83

18.3 Contrast settings 84

18.4 HotCodes 84

18.5 Key lock 85

Annex

A Menu structure 87

B Start-up protocol 95

C Maintenance protocol 97

D Legal information – open source licenses 99

E Conformity declarations 103



1 Introduction

This operating instruction has been written for users operating the process refractometer PIOX R532. It contains important information about the measuring equipment, how to handle it correctly, and how to avoid damages. Read the safety instructions carefully. Make sure you have read and understood the operating instruction before using the measuring equipment.

Any work on the measuring equipment has to be carried out by authorized and qualified personnel only, able to detect and avoid possible risks and dangers.

Presentation of warnings

This operating instruction contains warnings marked as follows:

| | |
|--|---|
| Danger! | |
|  | Type and source of danger danger with high level of risk, which, if not avoided, can lead to death or serious injuries → measures of prevention |
| Warning! | |
|  | Type and source of danger danger with medium level of risk, which, if not avoided, can lead to serious or moderate injuries → measures of prevention |
| Caution! | |
|  | Type and source of danger danger with low level of risk, which, if not avoided, can lead to moderate or minor injuries → measures of prevention |
| Important! | |
| This text contains important information which should be observed in order to avoid material damage. | |
| Notice! | |
| This text contains important information about the handling of the measuring equipment. | |

Storage of the operating instruction

The operating instruction must permanently be available at the place where the measuring equipment is used. It must be available to the user at all times.

User comments

All reasonable effort has been made to ensure the correctness of the content of this operating instruction. If you, however, find some erroneous information or miss information, please inform us.

We will be grateful for any suggestions and comments regarding the concept and your experience when working with the measuring equipment. If you have any suggestions about improving the documentation and particularly this operating instruction, please let us know so that we can consider your comments for future reprints.

Copyright

The contents of this operating instruction are subject to changes without prior notice. All rights reserved. No part of this operating instruction may be reproduced in any form without FLEXIM's written permission.

2 Safety instructions







2.1 General safety instructions

Prior to any work, read the operating instruction carefully and in full.

Failure to comply with the instructions, in particular with the safety instructions, poses a risk to health and can lead to material damages. For further information, contact FLEXIM.

During installation and operation of the measuring equipment, observe the ambient and installation conditions specified in the documentation. The measuring equipment comprises the transmitter, the sensors and the accessories.

Explanation of symbols on the transmitter and accessories:

| symbol | meaning |
|---|--|
|  | direct current |
|  | connection for equipotential bonding/grounding |
|  | protective ground terminal |
|  | Electric devices and batteries must be disposed of separately. If necessary, additional hazardous substances are indicated for disposal. |
|  | Warning! Electric shock possible. |
|  | Observe the operating instruction. |
|  | Warning! Observe the safety instructions in the manufacturer's documentation. |

The measuring equipment has to be checked for proper condition and operational safety before each use. If troubles or damages have occurred during installation or operation of the measuring equipment, please inform FLEXIM.

It is not allowed to make unauthorized modifications or alterations to the measuring equipment.

The personnel has to be suitably trained and experienced for the work.

2.2 Intended use

The measuring equipment is intended for the measurement of fluid properties in closed pipes. The refractive index and temperature are measured via the connected sensor.

The transmitter uses the measured values to calculate the sought analysis quantities, e.g., concentration.

Through comparison with the values stored in the transmitter, further physical quantities can be calculated.

The physical quantities are provided via the outputs and the display.

- All instructions of this operating instruction have to be observed to ensure intended use.
- Any use beyond or other than the intended use is not covered by warranty and can present a danger. Any damage arising from not intended use shall be solely the liability of the operator or user.
- The sensor is installed into a standardized flange using the supplied process connection.
- Observe the operating conditions, e.g., environment, voltage ranges. For technical data of the transmitter, sensor and accessories, see technical specification.

2.3 Not intended use

Not intended use in terms of a misuse means:

- any work on the measuring equipment without observing all instructions in this operating instruction
- use of transmitter, sensor and accessories combinations not intended by FLEXIM
- installation of the transmitter, sensor and accessories in explosive atmospheres they are not approved for
- any work on the measuring equipment (e.g., installation, dismantling, connection, start-up, operation, service and maintenance) carried out by unauthorized and untrained personnel
- storage, installation and operation of the measuring equipment outside the specified ambient conditions (see technical specification)

2.4 Safety instructions for the user

Any work on the transmitter has to be carried out by authorized and qualified personnel. Observe the safety instructions in the operating instruction. For the technical data of the transmitter, sensor and accessories, see technical specification.

- Observe the safety and accident prevention regulations applicable on the site of operation.
- Only use the supplied mounting fixtures, the sensor as well as the intended accessories.
- Always wear the required personal protective equipment.

2.5 Safety instructions for the operator

- The operator shall qualify the personnel to perform their assigned tasks. The operator shall provide the required personal protective equipment and oblige the personnel to wear it. It is recommended to risk assess the workplace.
- Besides the safety instructions in this operating instruction, the health, safety and environment regulations applicable for the range of application of the transmitter, sensor and accessories have to be observed.
- With the exceptions stated in chapter 11, the measuring equipment is maintenance-free. Any components and spare parts may only be replaced by FLEXIM. The operator shall carry out periodic checks for changes or damages that can present a danger. For further information, contact FLEXIM.
- Observe the specifications for the installation and connection of the transmitter, sensor and accessories.

2.6 Safety instructions for electrical work

- Prior to any work on the transmitter (e.g., installation, dismantling, connection, service and maintenance), the transmitter has to be disconnected from the power supply. It is not sufficient to remove the internal fuse of the instrument.
- Electrical work may only be carried out if there is enough space.
- Open the transmitter in safe ambient conditions only (e.g., air humidity < 90 %, no conductive pollution, no explosive atmosphere). Otherwise, additional protective measures have to be taken.
- The degree of protection of the transmitter is only ensured if all cables are tightly fitted using cable glands and the housing is firmly screwed.
- The condition and tight fit of the electrical connections have to be checked at regular intervals.
- When connecting the transmitter to the power supply, an appropriate equipment switch according to IEC 60947-1 and IEC 60947-3 has to be installed as disconnecting device. The equipment switch has to disconnect all live wires. The ground conductor connection must not be interrupted. The equipment switch has to be easily accessible and clearly marked as a disconnecting device for the transmitter. It should be located near the transmitter. If the transmitter is used in an explosive atmosphere, the equipment switch has to be installed outside the explosive atmosphere. If this is not possible, it has to be installed in the least hazardous area.
- The connection may only be made to networks up to overvoltage category II. When connecting the inputs and outputs as well as the power supply, observe the installation instructions, in particular the terminal assignment.

Fig. 2.1: Transmitter PIOX R532

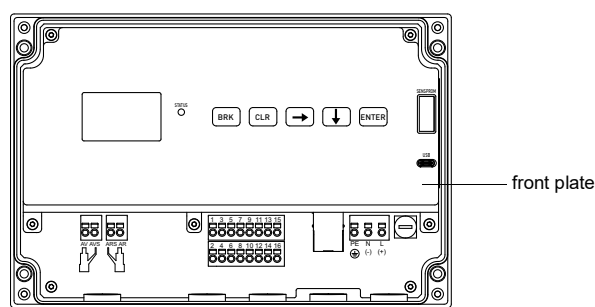

2.7 Safety instructions for transport

Caution!



Warning of injuries due to falling objects

- Unsecured and falling objects can lead to severe injuries.
- Secure all components against falling during transport.
 - Wear the required personal protective equipment.
 - Observe the applicable rules.

- If you detect a transport damage when unpacking the delivery, please contact the supplier or FLEXIM immediately.
- The transmitter is a sensitive electronic measuring instrument. Avoid shocks or impacts.
- Handle the sensor cable with care. Avoid excessive bending or buckling. Observe the ambient conditions.
- Select a solid surface to put the transmitter, sensor and accessories on.
- The transmitter, sensor and accessories have to be properly packed for transport:
 - Use, if possible, the original packaging by FLEXIM or an equivalent cardboard box.
 - Position the transmitter, sensor and accessories in the middle of the cardboard box.
 - Fill any voids with appropriate packaging material (e.g., paper, foam, bubble wrap).
 - Protect the cardboard box against humidity.

2.8 Recommended procedure in hazardous situations

Fire fighting measures

- If possible, disconnect the transmitter from the power supply.
- Prior to extinguishing, protect any electrical parts that are not affected by the fire (e.g., using a cover).
- Select a suitable extinguishing agent. Avoid, if possible, conductive extinguishing agents.
- Observe the applicable minimum distances. The minimum distances differ depending on the used extinguishing agent.

3 General principles

3.1 Measurement principle

Terms and abbreviations

| term/abbreviation | explanation |
|-----------------------------|--|
| analyte | components of a mixture which are to be chemically analyzed |
| matrix | components of a mixture which are not to be chemically analyzed |
| fluid data set | data set containing fluid and its properties |
| • standard fluid data set | data set of a standard fluid (one of the most important watery solutions) |
| • customized fluid data set | data set of a customized fluid |
| scale | conversion to a scale value for an arbitrary or unknown material system (e.g., Brix scale) |

Determination of the refractive index

The refractive index of a fluid is determined using transmitted light refractometry. A light beam propagates through the fluid and is refracted at the interface of a measuring prism. The angle of refraction is measured and used for the calculation of the refractive index.

The refractive index is calculated using Snell's law of refraction:

$$n_i \cdot \sin\theta_i = n_t \cdot \sin\theta_t$$

where

- n_i – refractive index of the fluid
- n_t – refractive index of the measuring prism
- θ_i – angle of incidence
- θ_t – angle of refraction

An LED with a wave length $\lambda = 590$ nm (sodium D-line) is used as the light source. The light passes through a slit, is parallelized by a lens and reversed by a deviating prism.

Then the light enters the fluid through a window and hits a measuring prism. The light beam is split and refracted at the lateral surfaces of the measuring prism.

The resulting light rays are focused in a lens and reproduced on the image sensor creating 2 slit images. The angle of refraction is determined from the distance between the 2 slit images. Influences of pressure and temperature are compensated.

Fig. 3.1: Path of light beam within the sensor

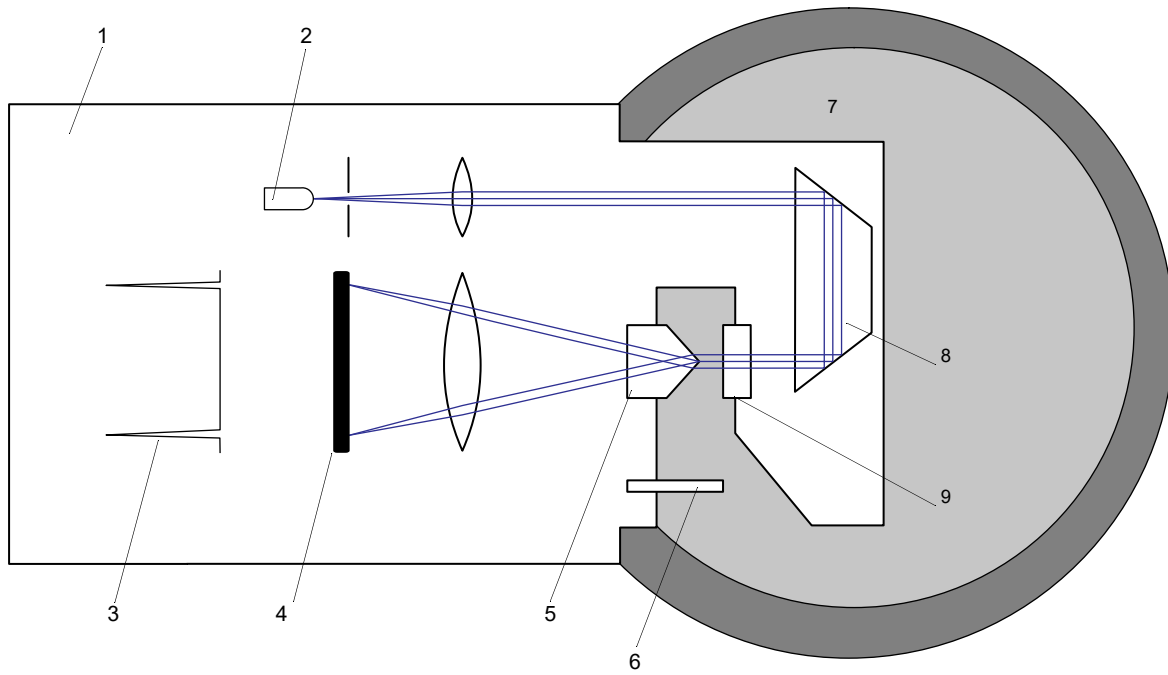

- 1 – sensor electronics
- 2 – LED
- 3 – slit image
- 4 – image sensor
- 5 – measuring prism
- 6 – temperature probe
- 7 – fluid
- 8 – deviating prism
- 9 – window

Determination of the concentration

The concentration is determined with the refractive index.

The refractive index depends on the temperature and concentration of the fluid. This relationship between temperature, refractive index and concentration is depicted with a function. The coefficients and the function are stored in a fluid data set.

Fig. 3.2: Characteristic curves (saccharose solution)

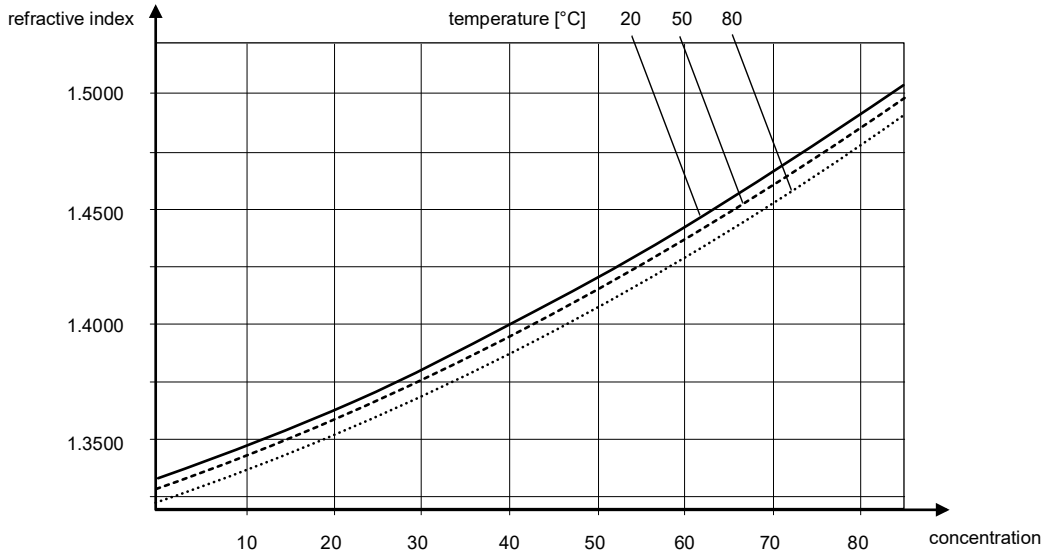

Temperature compensation

For industrial applications, it is often necessary not to determine the refractive index of the measured fluid temperature but rather at a reference temperature. The transmitter converts the refractive index.

In case temperature coefficients for the fluid are stored, they will be used to calculate the refractive index at a reference temperature.

Multi-component system

If the fluid consists of more than 2 components, apart from the refractive index and the temperature, other physical quantities (e.g., sound speed, density, conductivity) are needed to determine the physical quantities for analysis. These physical quantities can be read via the fieldbuses and are processed with the fluid data set stored in the transmitter. For the connection of the fieldbuses to the transmitter, see supplement to operating instruction.

3.2 Diagnostic values

Amplitude

The amplitude (unit: %) is the ratio of max. values of the signals to the product of LED lightness and exposure time of the image sensor. At delivery, the amplification with water is normalized to 100 %.

Amplification (gain)

The amplification (unit: dB) is the ratio of max. values of the signals to the product of LED lightness and exposure time of the image sensor. At delivery, the amplification with water is normalized to 20 dB. 0.01 % of the amplification corresponds to a image amplification of 100 dB.

Symmetry

Symmetry is the relation of amplitudes of both slit images. At delivery, they are optically adjusted to the same value.

Quality

The quality (unit: %) is an evaluation of the signal shape in comparison to the ideal one.

SNR

The SNR (unit: dB) is the ratio of useful signal and noise signal. A high SNR is ideal.

Combination of diagnostic values

It is possible to realize a combined evaluation of diagnostic values to determine the cause of error in situations with strong light scattering:

- A contaminated measurement optics and a turbid fluid can lead to a very low amplitude (e.g., < 0.1 %) or to a very high amplification (> 80 dB).
- A contaminated measurement optics and optical maladjustment lead to a symmetry $\gg 1$ or $\ll 1$.
- A contaminated measurement optics decreases the quality more than a turbid fluid.
- A turbid fluid decreases the SNR more than a strongly absorbing fluid.

3.3 Sensor values

Sensor humidity

The relative humidity within the sensor electronics is measured with an integrated humidity sensor. The humidity sensor only measures water vapor but does not measures other vapors. The sensor humidity must not exceed 80 %.

Sensor temperature

The temperature within the sensor electronics is measured with an integrated temperature sensor.

4 Product description

The transmitter and sensor are the main components of the process refractometer. Both are interconnected with the supplied cable.

Fig. 4.1: Measuring setup

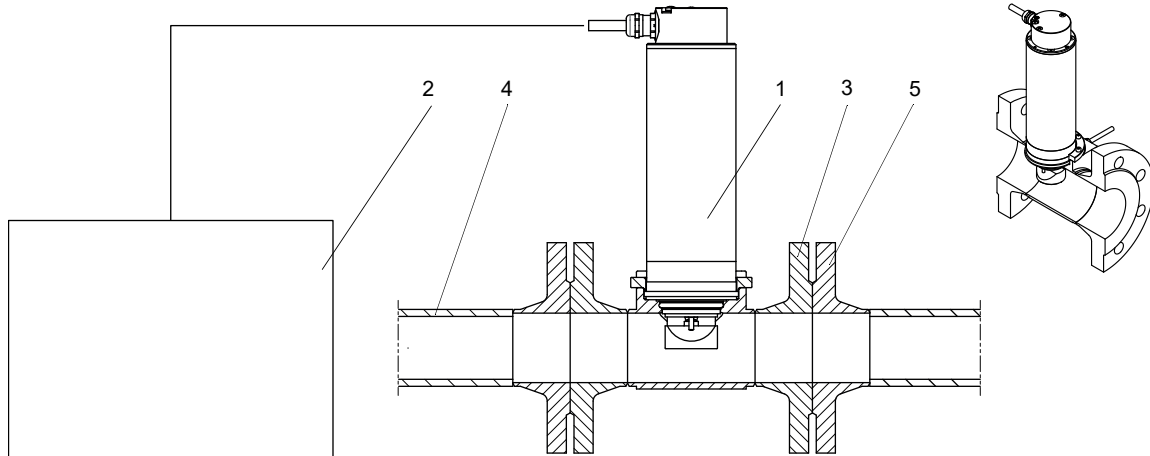

- 1 – sensor
- 2 – transmitter
- 3 – process connection (example)
- 4 – pipe
- 5 – connection (customer side)

4.1 Handling concept

The transmitter is operated via the keyboard. By pressing  or CLR the menus are displayed consecutively.

Fig. 4.2: Command panel of the transmitter



- 1 – LCD display (backlit)
- 2 – keyboard

Tab. 4.1: Description of the menus

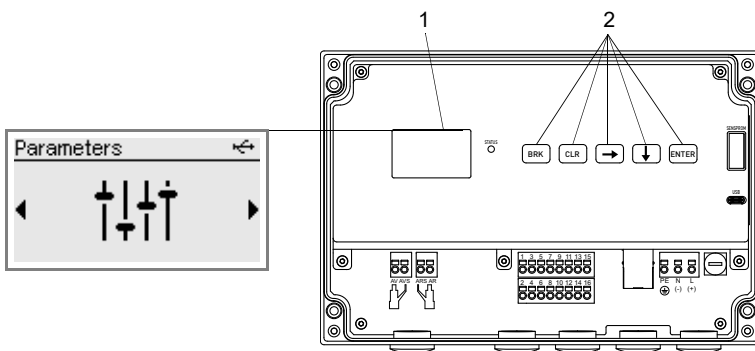
| menu | description |
|-------------------|---|
| Parameters | input of sensor and fluid parameters |
| Start measurement | measurement start ⁽¹⁾ |
| Show measurement | measured value display ⁽²⁾ |
| Stop measurement | measurement stop ⁽²⁾ |
| Inputs | input assignment ⁽³⁾ |
| Outputs | output configuration |
| Functions | configuration of event triggers R1...R4 |
| Storage | configuration of the data logger, deletion of measured values |
| Calibration | input of correction values, which are added to the calculated physical quantities or scale values |
| Communication | configuration of the communication interface (e.g., fieldbuses (optional)) |
| Miscellaneous | change of system, measurement and dialog/menu settings |

⁽¹⁾ will only be displayed if no measurement is running

⁽²⁾ will only be displayed if a measurement is running

⁽³⁾ will only be displayed if a fieldbus is connected

When starting up the transmitter for the first time, settings relating to the language, time, date and system of units have to be made. Afterwards the menu `Parameters` will be displayed.

At later start-ups the measured values will be displayed in case the measurement had not been stopped before the transmitter was disconnected from the power supply. If the measurement is stopped, the menu `Parameters` will be displayed.

After starting the measurement, the parameter settings or the configuration of the transmitter outputs can be displayed at any time without interrupting the measurement. A change of the parameter settings is not possible during the measurement. The measurement has to be stopped in order to change the parameter settings or configuration of the transmitter outputs.

4.2 Display

Structure

Fig. 4.3: Menu Parameters (example)

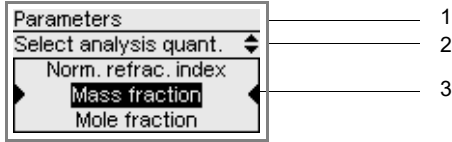

- 1 – menu
- 2 – menu item currently edited
- 3 – area for scroll lists, selection fields or input fields

Tab. 4.2: Navigation

| horizontal scroll list | vertical scroll list | input fields |
|--|---|--|
| | | |
| <ul style="list-style-type: none"> • scroll horizontally with or CLR | <ul style="list-style-type: none"> • scroll vertically with or | <ul style="list-style-type: none"> • input numbers or text with or • delete with CLR |



Status indications

Several symbols are used for the status indications.

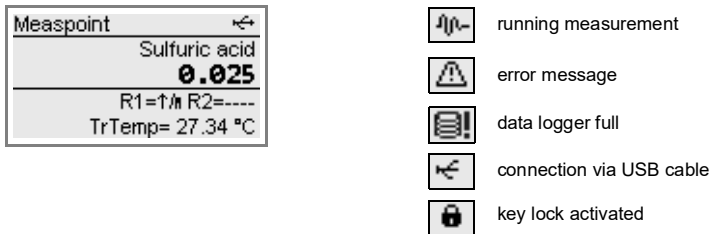
Fig. 4.4: Status indications (line 1)





4.3 Keyboard

The keyboard consists of the following keys: ENTER, BRK, CLR,  and . The keys are operated using a magnetic pen with the housing being closed.



Tab. 4.3: General functions

| | |
|-----------------|--|
| ENTER | confirmation of selection or input |
| BRK | during the parameter input: short press: return to the previous menu item long press (several seconds): return to the beginning of the menu during the measurement: display of scroll list: <i>Stop measurement, Show parameters, Show measurement</i> |
| BRK + C + ENTER | Reset: press these 3 keys simultaneously to correct a malfunction. The reset has the same effect as a restart of the transmitter. Stored data are not affected. |
| BRK + C | INIT: when initializing the transmitter, all settings are reset to the factory settings. |



Tab. 4.4: Navigation

| | |
|---|---|
|  | scroll to the right or up through a scroll list |
|  | scroll down through a scroll list |
| CLR | scroll to the left through a scroll list |

Tab. 4.5: Input of numbers

| | |
|---|--|
|  | move the cursor to the right |
|  | scroll through the numbers above the cursor |
| CLR | short press: move the cursor to the left long press (several seconds): reset the value to the previously stored one |

Tab. 4.6: Input of text

| | |
|---|---|
|  | move the cursor to the right |
|  | scroll through the characters above the cursor |
| CLR | short press: move the cursor to the left long press (several seconds): reset the text to the previously stored one |

5 Transport and storage

Caution!

**When packaging, the transmitter can fall down.**

There is a danger of crushing body parts or damaging the measuring equipment.

- Secure the transmitter against falling during packaging.
- Wear the required personal protective equipment.
- Observe the applicable rules.

Caution!

**When lifting, the center of gravity of the transmitter can be displaced within the cardboard box. The transmitter can fall down.**

There is a danger of crushing body parts or damaging the measuring equipment.

- Secure the transmitter against falling during transport.
- Wear the required personal protective equipment.
- Observe the applicable rules.

5.1 Transport

The measuring equipment must be packaged properly for transport. For weight indications, see technical specification.

- Use, if possible, the original packaging by FLEXIM or an equivalent cardboard box.
- Position the transmitter, sensor and accessories in the middle of the cardboard box.
- Fill any voids with appropriate packaging material (e.g., paper, foam, bubble wrap).
- Protect the cardboard box against humidity.

5.2 Storage

- Store the measuring equipment within the original package.
- Do not store the measuring equipment outdoors.
- Seal all openings with blind plugs.
- Protect the measuring equipment against sunlight.
- Storage the measuring equipment in a dry place without dust and within the valid temperature range (see technical specification).

6 Mounting

Warning!

**Installation, connection and start-up by unauthorized and unqualified personnel**

This may result in personal or material damage or dangerous situations.

→ Any work on the transmitter has to be carried out by authorized and qualified personnel.

Warning!

**Touching live parts**

Electric shock or arc faults can lead to severe injuries. The measuring equipment can be damaged.

→ Prior to any work on the transmitter (e.g., installation, dismantling, connection, start-up), the transmitter has to be disconnected from the power supply. It is not sufficient to remove the internal fuse of the instrument.

Caution!

**Safety and accident prevention regulations for electrical systems and equipment**

Failure to observe these regulations may lead to severe injuries.

→ Observe the safety and accident prevention regulations for electrical systems and equipment.

Caution!

**Touching hot or cold surfaces**

This may result in injuries (e.g., thermal damages).

→ Observe the ambient conditions at the measuring point during installation.
→ Wear the required personal protective equipment.
→ Observe the applicable rules.

Notice!

Protective foils on measuring equipment and sensor mounting fixture can be removed.

6.1 Transmitter

6.1.1 Opening and closing the housings

Opening

Important!

Do not use objects which may damage the housing gasket to open the housing cover.

- Loosen the screws of the transmitter housing.
- Open the housing cover of the transmitter.
- Remove the protection foils on the window of the housing cover (inside and outside) as well as on the transmitter display.

Closing

- Close the housing cover.
- Tighten the screws on the transmitter housing evenly.

Fig. 6.1: Transmitter

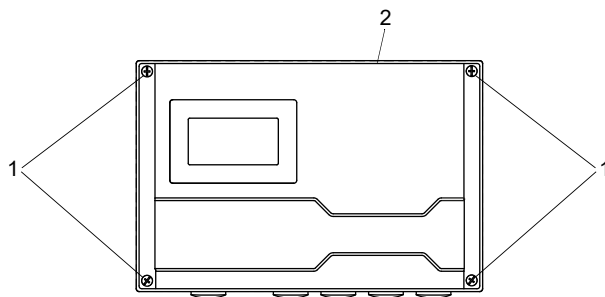

- 1 – screws
2 – housing cover

6.1.2 Installation of the transmitter

6.1.2.1 Wall mounting

- Loosen the screws of the transmitter housing.
- Open the housing cover of the transmitter.
- Fix the transmitter to the wall using 4 screws.

Fig. 6.2: Transmitter (dimensions in mm)

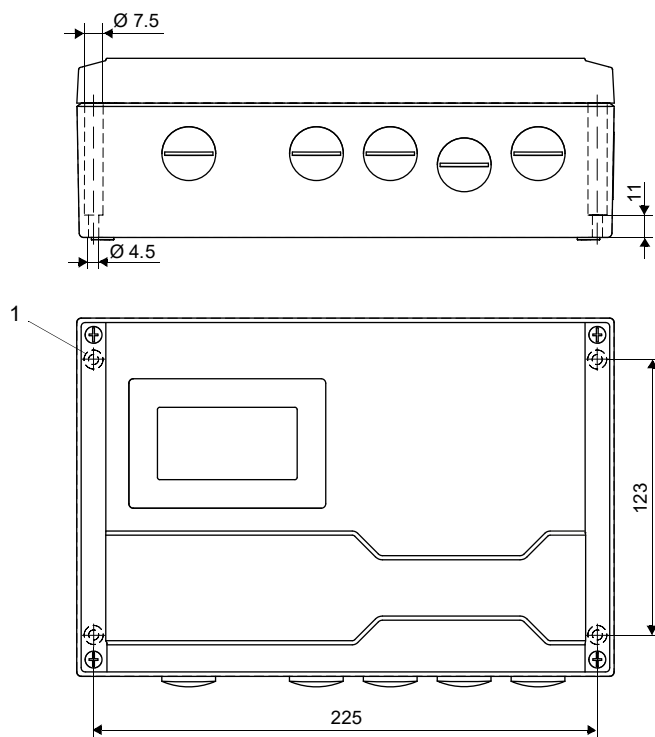

1 – fixing holes for wall mounting

6.1.2.2 Pipe mounting

Important!

The pipe has to be sufficiently stable to withstand the pressure exerted by the transmitter and the shackles.

Mounting on a 2" pipe

The pipe mounting kit is fixed to the pipe using a shackle.

- Fix the pipe mounting plate (2) to the instrument mounting plate (3) using the supplied screws. Make sure the pipe mounting plate is aligned corresponding to the pipe orientation.
- Fix the pipe mounting plate and the instrument mounting plate to the pipe using the nuts (4) and the shackle (1).
- Use the screws to fix the transmitter to the instrument mounting plate.

Fig. 6.3: Pipe mounting kit

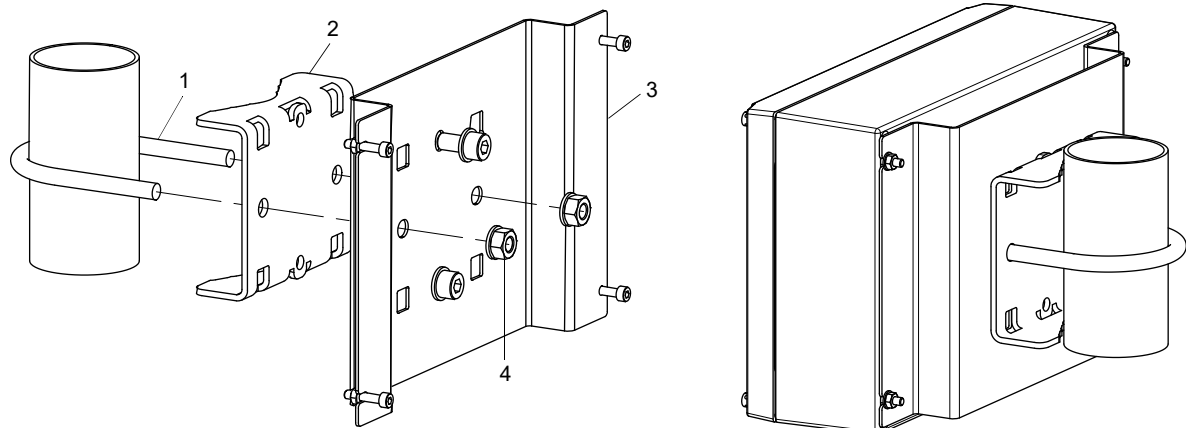

- 1 – shackle
- 2 – pipe mounting plate
- 3 – instrument mounting plate
- 4 – nut

Mounting on a pipe > 2"

The pipe mounting kit is fixed to the pipe by using tension straps.

Caution!



The edge of the tension strap is very sharp.

Risk of injury.

- Debur sharp edges.
- Wear the required personal protective equipment.
- Observe the applicable rules.

- Fix the pipe mounting plate (1) to the instrument mounting plate (2) using the supplied screws. Make sure the pipe mounting plate is aligned corresponding to the pipe orientation.
- Insert the tension straps (3) into the holes of the pipe mounting plate and the instrument mounting plate.
- Fix the pipe mounting plate and the instrument mounting plate to the pipe using the tension straps.
- Use the screws to fix the transmitter to the instrument mounting plate.

Fig. 6.4: Pipe mounting with tension straps

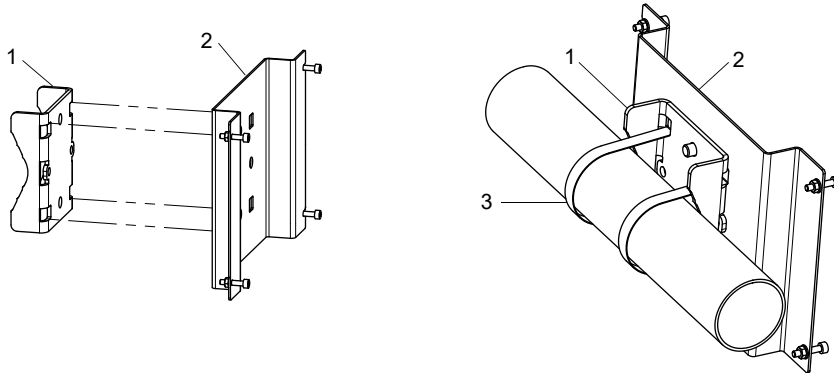

- 1 – pipe mounting plate
- 2 – instrument mounting plate
- 3 – tension strap

6.2 Sensor

6.2.1 Sensor design

The sensor consists of a sensor head with wetted parts (measuring prism, window, temperature probe) and the sensor housing containing the electronic components.

The junction box is situated at the rear part of the sensor housing.

The following 2 sensor designs are available:

- chemistry design
- hygiene design

The designs essentially differ in sealing concept and size and form of the optical components.

Fig. 6.5: Sensor PIOX R500 (chemistry design)

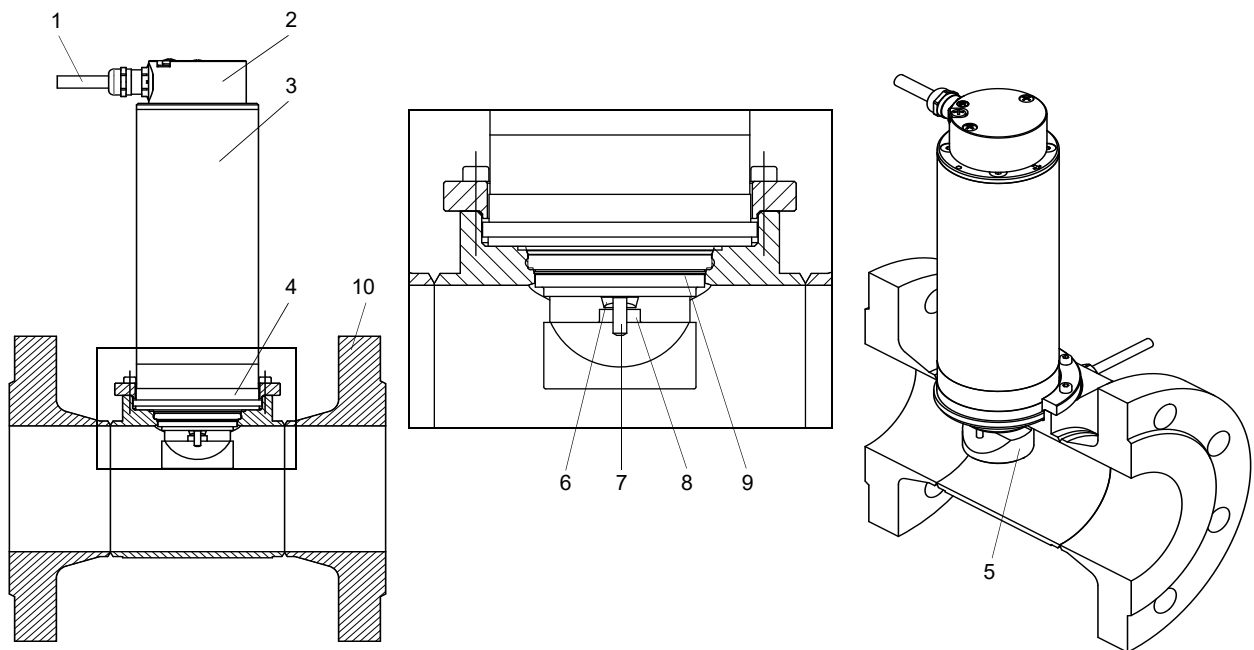

- 1 – sensor cable
- 2 – junction box with cover
- 3 – sensor housing with electronic components
- 4 – flange
- 5 – sensor head
- 6 – measuring prism
- 7 – temperature probe
- 8 – window
- 9 – O-ring
- 10 – process connection (example)

6.2.2 Mounting of the sensor

6.2.2.1 Selection of the measuring point

Caution!



Warning of severe injuries from hot or cold components

Touching hot or cold components can lead to severe injuries (e.g., thermal damage).

- Any mounting, installation or connection work has to be concluded.
- Any work on the measuring point during the measurement is prohibited.
- Observe the ambient conditions at the measuring point during installation.
- Wear the required personal protective equipment.
- Observe the applicable rules.

Danger!



Warning of severe injuries caused by leakage of dangerous fluids

Dangerous fluids can escape from insufficiently tightened screw connections. The contact to the fluid may result in personal or material damage or dangerous situations.

- The mounting has to be carried out with a reproducible torque procedure and defined screw tightening torque. The screw tightening torque depends on the used gasket and has to be defined by the customer.

- Select a measuring point:
 - which is representative for the process and relevant to the given application
 - where the sensor can quickly respond to changes in the process
 - where the pipe is always filled and no gas bubbles can form in the pipe
 - where the flow can be stopped and the sensor can be installed and removed without problems
- In order to counteract the formation of deposits on the measuring prism and the window, the measuring point should be selected in such a way that:
 - a minimum flow is always present in pipe
 - the sensor is installed in pipe segments with small pipe diameters because smaller pipe diameters cause higher pressures and, therefore a better cleaning effect
 - the fluid temperature is relatively high but always within the operating range of the sensor because higher temperatures increase the solubility and reduce the viscosity
- Select the location of the transmitter within the cable range of the measuring point. The ambient temperature at the measuring point has to be within the operating temperature range of the transmitter and the sensor (see technical specification).
- Protect the sensor against direct sunlight, rain and vibrations. The ambient temperature at the measuring point has to be within the operating temperature range of the sensor (see technical specification).

Important!

The sensor cable must never be wrapped around hot pipes.

If the measuring point is within an explosive atmosphere, possibly present danger zones and gases have to be determined. The transmitter and sensor have to be appropriate for these conditions.

Observe the notes in the following table.

Tab. 6.1: Sensor positioning on a horizontal pipe (basic presentation)

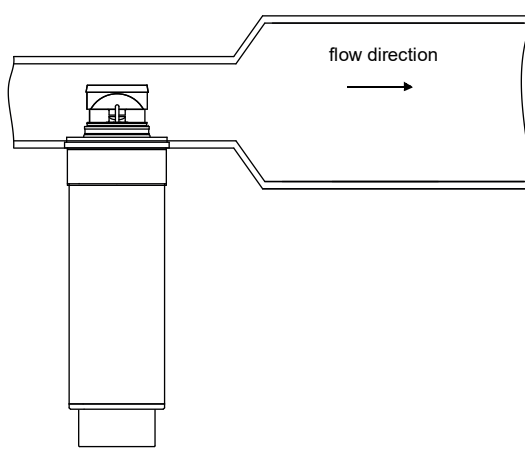
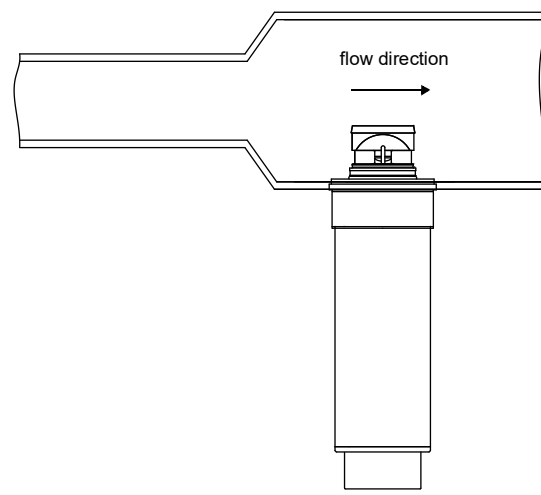
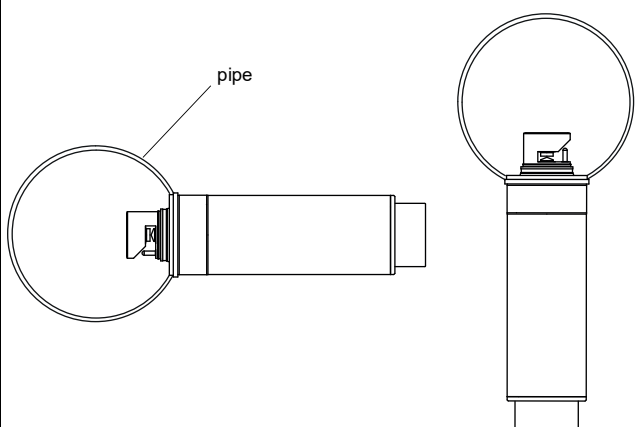
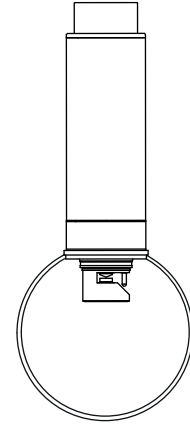
| Horizontal pipe | |
|--|---|
| <p>Diffuser If possible, install the sensor in the pipe segment with the smaller pipe diameter (if the flow direction is as indicated).</p> | |
| <p>correct</p>  | <p>disadvantageous</p>  |
| <p>Positioning of the sensor If possible, install the sensor on the side or at the bottom of the pipe in such a way that any gas bubbles at the top of the pipe do not influence the measurement.</p> | |
| <p>correct</p>  | <p>disadvantageous</p>  |

Tab. 6.1: Sensor positioning on a horizontal pipe (basic presentation)

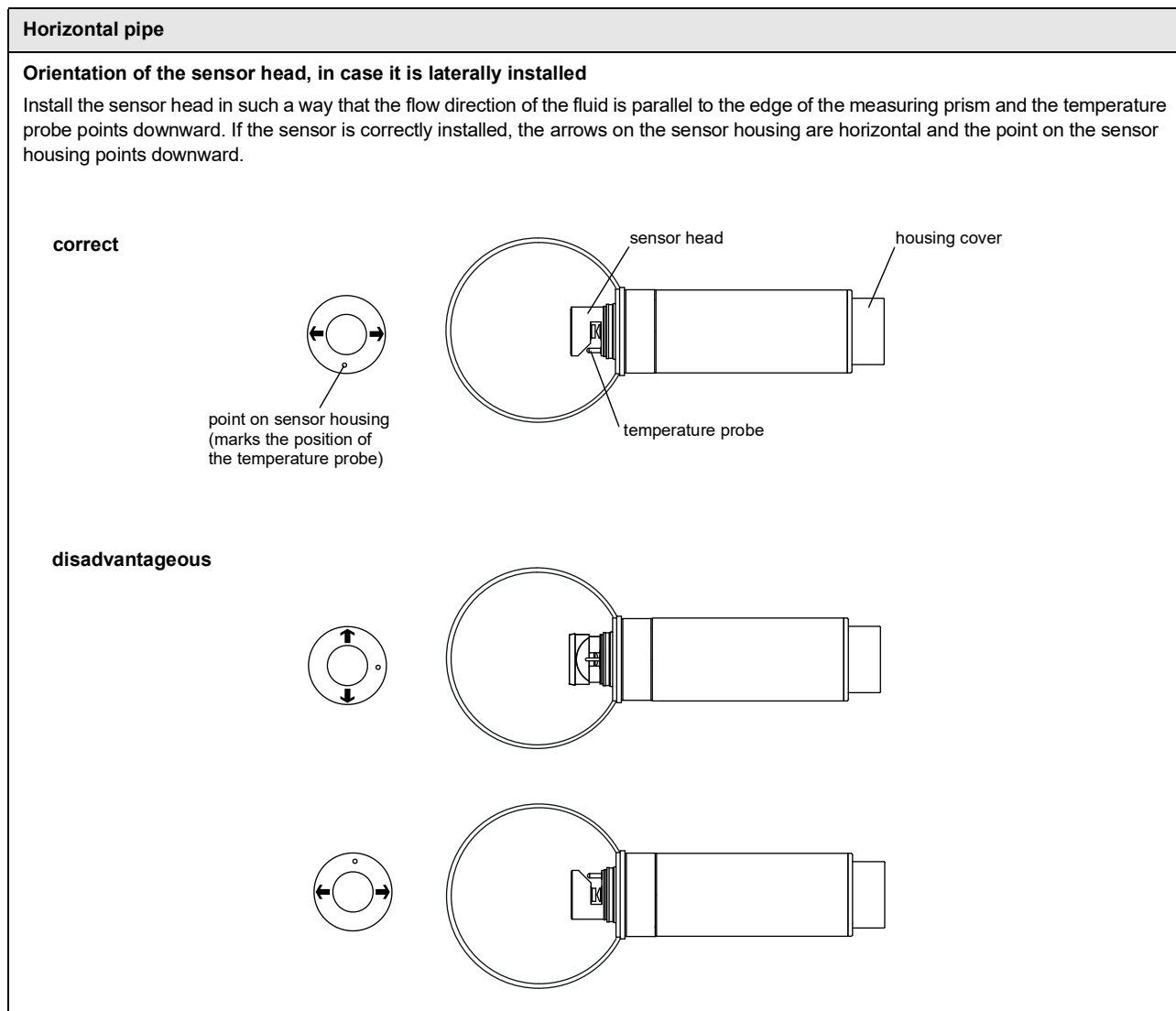

Tab. 6.1: Sensor positioning on a horizontal pipe (basic presentation)

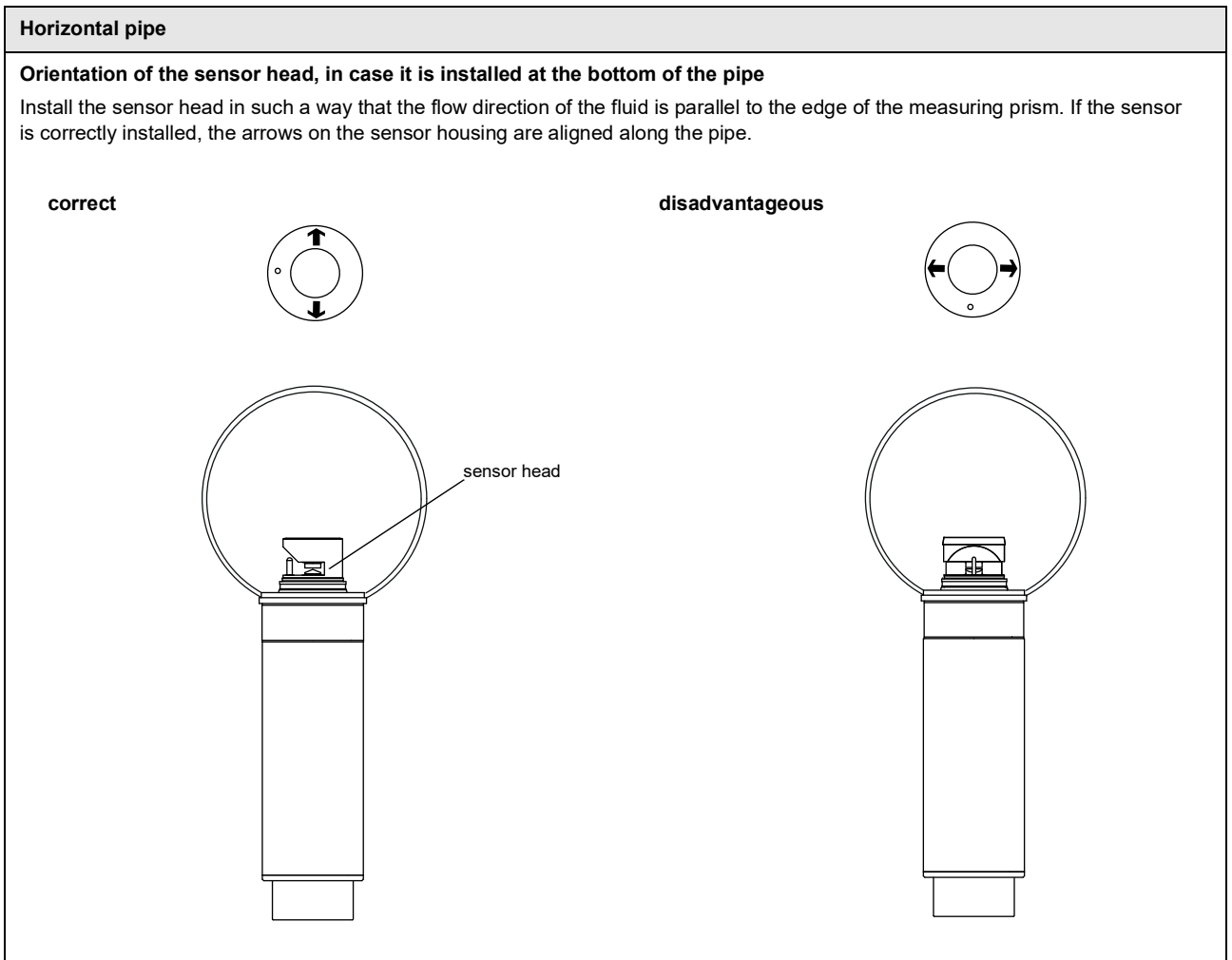

Tab. 6.2: Sensor positioning on a vertical pipe (basic presentation)

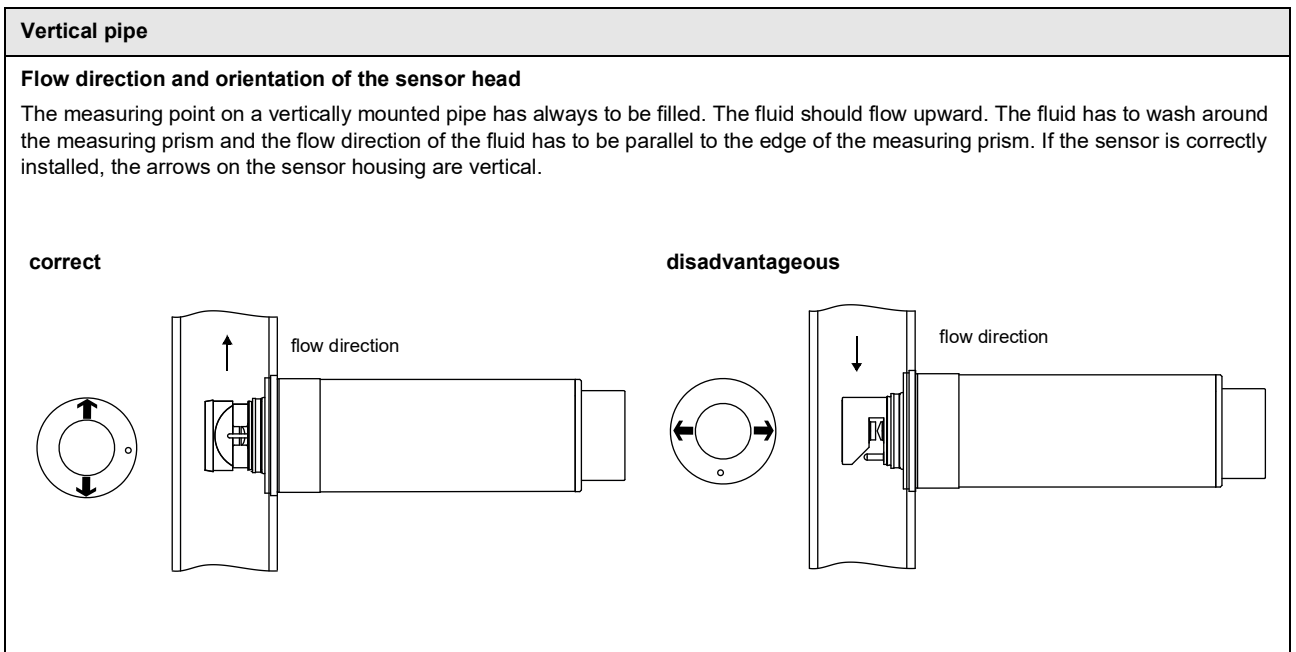

6.2.2.3 Installation of the sensor (chemistry design)

The sensor is installed into a standardized flange using the supplied process connection or directly flanged into a T-piece as a long version.

6.2.2.4 Installation of the sensor (hygienic design)

The sensor can be connected to the standardized clamp flange connection Varivent type N or TriClamp 3".

| |
|--|
| Important! |
| After installing the sensor, check the tightness of the complete system with a compression test. |

7 Connection

Warning!



Installation, connection and start-up by unauthorized and unqualified personnel

This may result in personal or material damage or dangerous situations.

→ Any work on the transmitter has to be carried out by authorized and qualified personnel.

Warning!



Touching live parts

Electric shock or arc faults can lead to severe injuries. The measuring equipment can be damaged.

→ Prior to any work on the transmitter (e.g., installation, dismantling, connection, start-up), the transmitter has to be disconnected from the power supply. It is not sufficient to remove the internal fuse of the instrument.

Caution!



Safety and accident prevention regulations for electrical systems and equipment

Failure to observe these regulations may lead to severe injuries.

→ Observe the safety and accident prevention regulations for electrical systems and equipment.

7.1 Sensor

It is recommended to run the cables from the measuring point to the transmitter before connecting the sensor to avoid load on the connectors.

7.1.1 Connection of the cable to the sensor

Important!

The degree of protection of the transmitter is only ensured if all cables are tightly fitted using cable glands and the housing is firmly screwed.

- Loosen the 2 screws on the junction box of the sensor.
- Remove the housing cover.
- Remove the blind plug on the housing cover to connect the sensor cable.
- Open the cable gland of the sensor cable. The compression part remains in the cap nut.
- Insert the sensor cable through the cap nut, the compression part and the basic part.
- Prepare the sensor cable with the cable gland.
- Insert the sensor cable through the housing cover.
- Tighten the gasket ring side of the basic part firmly into the housing cover.
- Connect the sensor cable to the terminals of the transmitter.

Important!

The external shield of the sensor cable must not have any electrical contact to the sensor housing.

Tab. 7.1: Terminal assignment

| terminal | connection |
|----------|------------|
| + | yellow |
| - | green |
| A+ | brown |
| B- | white |
| S | shield |

Fig. 7.1. Sensor PIOX R500

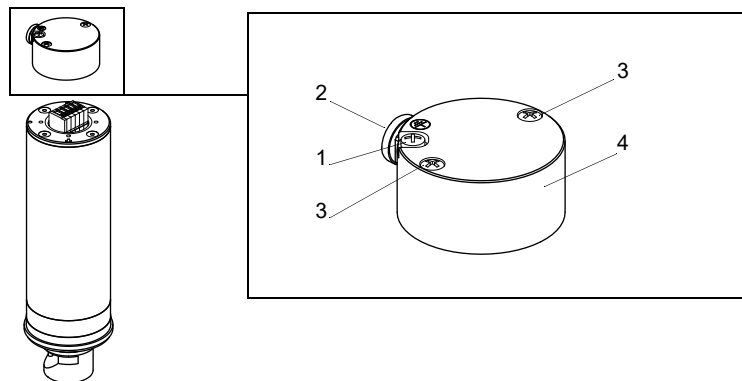

- 1 – equipotential bonding terminal
- 2 – blind plug
- 3 – screws
- 4 – housing cover

Fig. 7.2: Preparation of the sensor cable

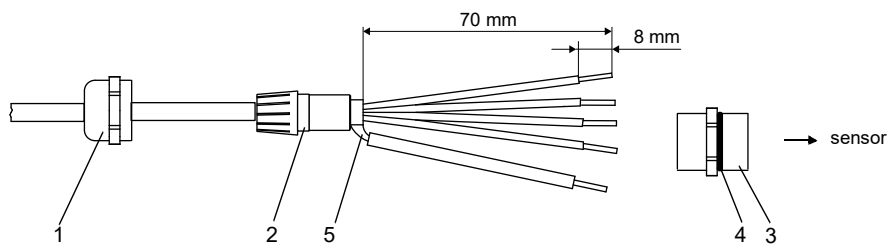

- 1 – cap nut
- 2 – compression part
- 3 – basic part
- 4 – gasket ring side of the basic part
- 5 – external shield

- Position the housing cover with the screws on the holes. Observe the orientation of the cable entries on the housing cover.
- Tighten the screws.
- Fix the cable gland by screwing the cap nut onto the basic part.

Fig. 7.3: Connection of the sensor cable and terminal strip

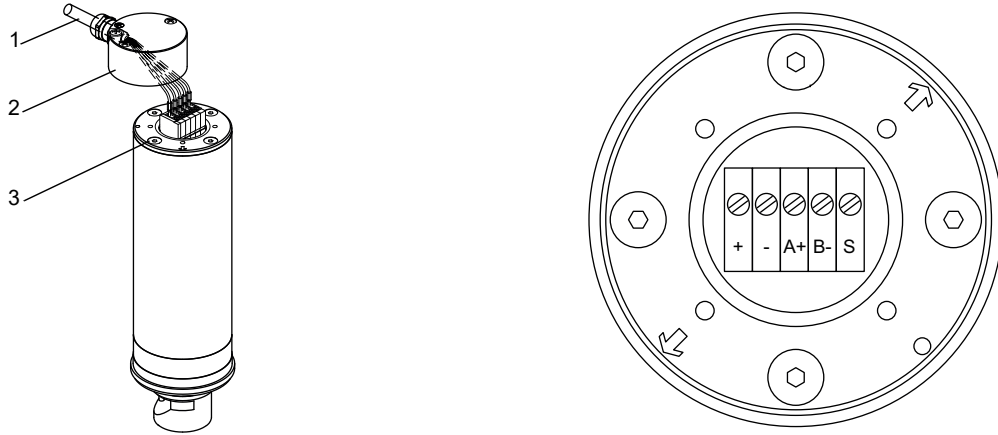

- 1 – sensor cable
- 2 – housing cover
- 3 – hole

7.1.2 Connection of the sensor cable to the transmitter

Important!

The degree of protection of the transmitter is only ensured if all cables are tightly fitted using cable glands and the housing is firmly screwed.

- Remove the blind plug on the left for the connection of the sensor cable.
- Open the cable gland of the sensor cable. The compression part remains in the cap nut.

Notice!

For the connection of the sensor cable to the transmitter, cable glands made from metal have to be used.

- Push the sensor cable through the cap nut and the compression part.
- Prepare the sensor cable.
- Shorten the external shield and brush it back over the compression part.
- Screw the gasket ring side of the basic part tightly into the housing of the transmitter.
- Insert the sensor cable into the housing.
- Fix the cable gland by screwing the cap nut onto the basic part.
- Connect the sensor cable to the terminals of the transmitter.

Tab. 7.2: Terminal assignment

| terminal | connection |
|----------|------------|
| 1 | brown |
| 3 | green |
| 2 | white |
| 4 | yellow |

Fig. 7.4: Connection of the sensor to the transmitter

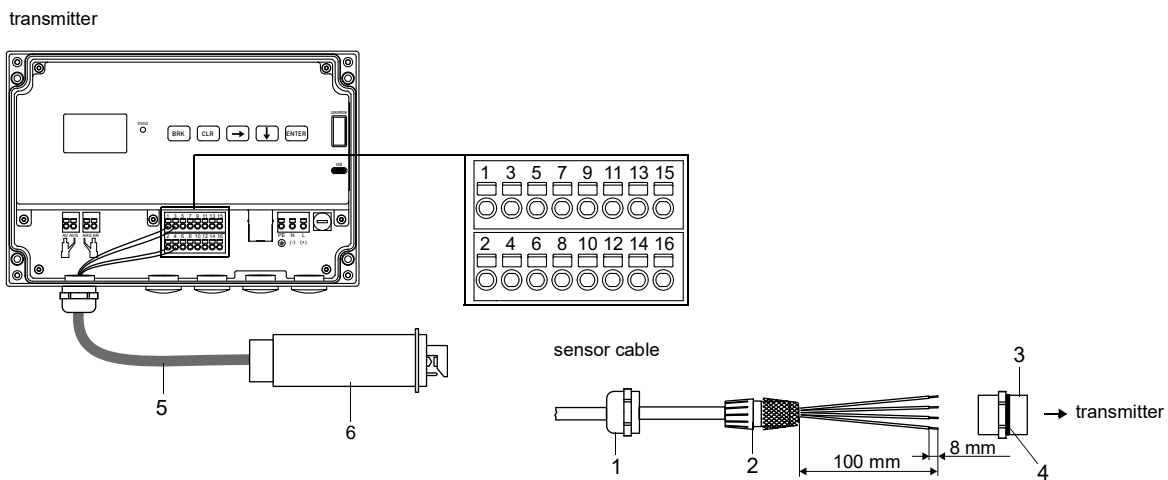

- 1 – cap nut
- 2 – compression part
- 3 – basic part
- 4 – sealing ring side of the basic part
- 5 – sensor cable
- 6 – sensor

7.2 Power supply

The installation of the power supply is carried out by the operator. The operator has to provide an overcurrent protector of max. 16 A (fuse or similar device) disconnecting all energizing wires in case of an inadmissible high current consumption. The impedance of the protective ground has to be low ohmic in order not to allow touch voltage pass the permissible limit.

| |
|--|
| Important! |
| The degree of protection of the transmitter will only be guaranteed if the power cable fits firmly and tightly in the cable gland. |

- Connect the power cable to the transmitter (see section 7.2.1, Fig. 7.5 and Tab. 7.3).

Fig. 7.5: Connection of the power supply to the transmitter

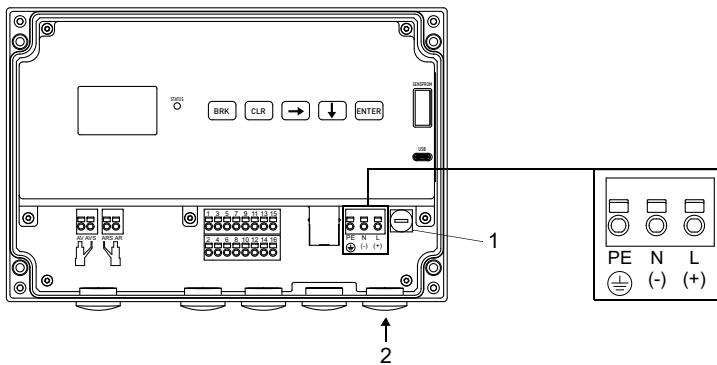

- 1 – fuse
- 2 – connection of the power supply

Tab. 7.3: Terminal assignment

| terminal | connection AC | connection DC |
|----------|----------------------|----------------------|
| L(+) | outer conductor | DC |
| N(-) | neutral conductor | GND |
| PE | protective conductor | protective conductor |

7.2.1 Cable connection

- Remove the blind plug to connect the cable to the transmitter.
- Prepare the cable with an M20 cable gland. The used cable has to have a wire cross-section of 0.25...2.5 mm².
- Push the cable through the cap nut, compression part and basic part of the cable gland.
- Insert the cable into the transmitter housing.
- Screw the sealing ring side of the basic part into the transmitter housing.
- Fix the cable gland by screwing the cap nut onto the basic part.

If the transmitter is connected to a AC power supply, the power cable has to be prepared as shown in Fig. 7.7.

- Connect the cable to the terminals of the transmitter.

Fig. 7.6: Cable gland

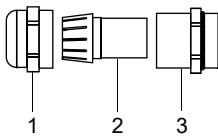

- 1 – cap nut
- 2 – compression part
- 3 – basic part

Fig. 7.7: Preparation of the power cable

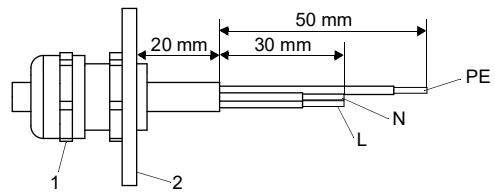

- 1 – cable gland
- 2 – transmitter housing

7.3 Outputs

Important!

The max. permissible voltage between the outputs and against PE is 60 V DC (permanent).

Fig. 7.8: Connection of the outputs to the transmitter

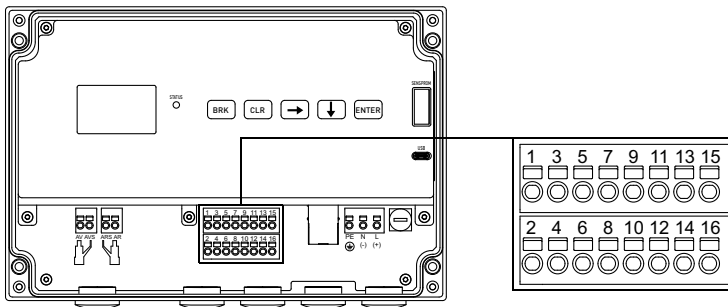

7.3.1 Output circuits

Tab. 7.4: Switchable current output Ix

| transmitter | | external circuit | remark |
|------------------|--------------|------------------|---|
| internal circuit | connection | | |
| active | | | |
| | x+ x- | | $R_{ext} = 250...530 \Omega$ $U_{opencircuit} = 28 \text{ V DC}$ adjustable fault current (no valid measured value, no measurement): 3.2...3.99 mA, 20.01...24 mA hardware fault current: 3.2 mA |
| passive | | | |
| | x+ x- | | $U_{ext} = 9...30 \text{ V DC}$, dependent on R_{ext} ($R_{ext} < 458 \Omega$ with 20 V) adjustable fault current (no valid measured value, no measurement): 3.2...3.99 mA, 20.01...24 mA hardware fault current: 3.2 mA |

Tab. 7.5: Switchable current output Ix/HART

| transmitter | | external circuit | remark |
|------------------|--------------|------------------|---|
| internal circuit | connection | | |
| active | | | |
| | x+ x- | | $R_{ext} = 250...530 \Omega$ $U_{opencircuit} = 28 \text{ V DC}$ adjustable fault current (no valid measured value, no measurement): 3.5...3.99 mA, 20.01...22 mA hardware fault current: 3.2 mA |
| passive | | | |
| | x+ x- | | $U_{ext} = 9...30 \text{ V DC}$, dependent on R_{ext} ($R_{ext} = 250...458 \Omega$ with 20 V) adjustable fault current (no valid measured value, no measurement): 3.5...3.99 mA, 20.01...22 mA hardware fault current: 3.2 mA |

Tab. 7.6: Digital output (according to IEC 60947-5-6 (NAMUR))

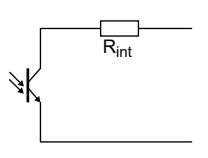
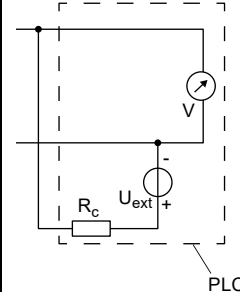
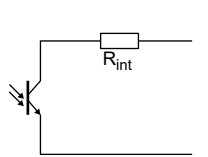
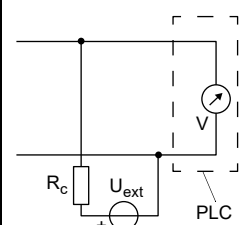
| transmitter | | external circuit | remark |
|---|---------------------|--|--|
| internal circuit | connection | | |
| circuit 1 | | | |
|  | <p>x+</p> <p>x-</p> |  | <p>$U_{ext} = 8.2 \text{ V}$ $I_{max} = 8 \text{ mA with } 29 \text{ V DC}$ $f = 2 \dots 10 \text{ kHz}$ $T_p = 0.05 \dots 1000 \text{ ms}$</p> |
| circuit 2 | | | |
|  | <p>x+</p> <p>x-</p> |  | |

For all circuits apply:

- R_{ext} is the sum of all ohmic resistances in the circuit (e.g., resistance of the conductors, resistance of the ammeter/voltmeter).
- The number, type and connections of the outputs depend on the order.
- The terminal assignment is displayed on the transmitter during configuration of the outputs.

7.4 Service interfaces

7.4.1 USB interface

The transmitter can be connected directly to the PC via the USB interface.

- Connect the USB cable to the USB interface of the transmitter and to the PC.

Fig. 7.9: Connection of the USB cable

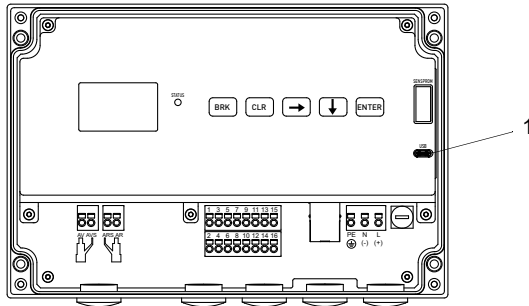

1 – USB interface

7.4.2 LAN interface

The transmitter can be connected to a PC or the local area network via the LAN cable.

Fig. 7.10: Connection of the LAN cable

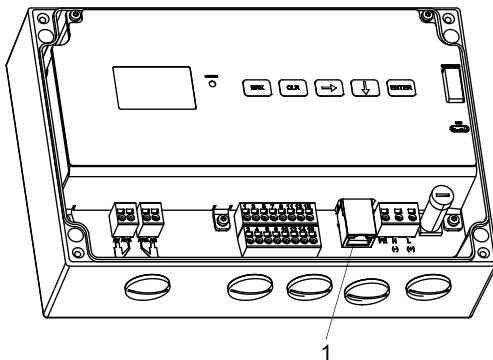

1 – LAN interface

- Remove the blind plug to connect the cable to the transmitter.
- Slide the flat gasket ring onto the LAN cable.
- Insert the cable into the transmitter housing.
- Insert the connector into the LAN interface port.
- Mount the split cable gland on the LAN cable.
- Slide the flat gasket ring onto the cable gland and screw the latter into the transmitter housing.

Fig. 7.11: Split cable gland

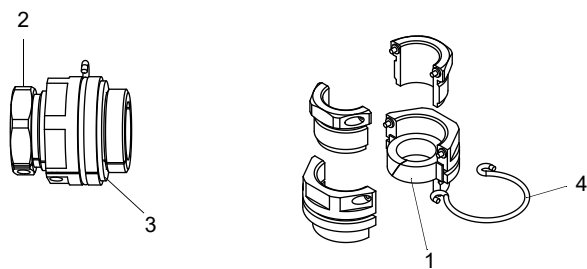

- 1 – split sealing ring
- 2 – split fitting
- 3 – flat gasket ring
- 4 – annular spring

8 Start-up

Warning!



Installation, connection and start-up by unauthorized and unqualified personnel

This may result in personal or material damage or dangerous situations.

→ Any work on the transmitter has to be carried out by authorized and qualified personnel.

Caution!



Safety and accident prevention regulations for electrical systems and equipment

Failure to observe these regulations may lead to severe injuries.

→ Observe the safety and accident prevention regulations for electrical systems and equipment.

Caution!



Warning of severe injuries from hot or cold components

Touching hot or cold components can lead to severe injuries (e.g., thermal damage).

→ Any mounting, installation or connection work has to be concluded.

→ Any work on the measuring point during the measurement is prohibited.

→ Observe the ambient conditions at the measuring point during installation.

→ Wear the required personal protective equipment.

→ Observe the applicable rules.

Notice!

The transmitter and the sensor have to be checked for proper condition and operational safety before each use. The housing of the transmitter must always be closed during operation. Observe that maintenance work must be concluded.

8.1 Start-up settings

When starting up the transmitter for the first time, the following settings are required:

- language
- time/date
- system of units

These displays will only be indicated when the transmitter is switched on for the first time or after an initialization.

Language

The available transmitter languages are displayed.

- Select a language.
- Press ENTER.

The menus are displayed in the selected language.

Set time

The current time is displayed.

- Press ENTER to confirm the time or set the current time via the numeric field.
- Press ENTER.

Set date

The current date is displayed.

- Press ENTER to confirm the date or set the current date via the numeric field.
- Press ENTER.

Units of measurement

- Select `Metric` or `Imperial`.
- Press ENTER.

Region of Canada

- Select `Yes` if the transmitter is to be used in the region of Canada.
- Press ENTER.

This display will only be indicated if `Imperial` is selected.

8.2 Switching on

As soon as the transmitter is connected to the power supply, the menu is displayed in the adjusted language. The language can be changed.

Notice!

The parameters cannot be changed during the measurement. The measurement has to be stopped in order to change the parameters.

If the transmitter was switched off during the measurement, the message `Measurement started` will be displayed after connecting the transmitter to the power supply. The measurement continues with the parameters set last.

By pressing BRK in the menu `Measurement` it is possible either to stop the measurement or to display the current parameter settings.

8.3 Language

Miscellaneous\System settings\Language

The language of the transmitter can be selected:

- Select the menu item `Language`.
- Press ENTER.
- Select the desired language from the scroll list.
- Press ENTER.

Afterwards the menu will be displayed in the selected language. The selected language remains activated when the transmitter is switched off and on again.

The language can also be changed by entering a HotCode.

8.4 Initialization

During an initialization (INIT) of the transmitter, all settings are reset to factory default. The initialization is started with the HotCode **909000**.

During an initialization it is tested whether the key lock is activated. If so, it has to be deactivated.

- Enter the 6-digit key lock code. For the input of numbers, see section 4.3.
- Press ENTER.

If a measurement is running, it will be stopped.

It will be asked whether the initial settings are to be carried out.

```
Initial settings
```

If Yes is selected, the following setting dialogs will be displayed:

- Language
- Date/time
- Units of measurement
- Delete meas. values
- Delete user subst. (all customized fluids which were stored after delivery will be deleted)

The initialization can also be started with the HotCode **909000**.

8.5 Date and time

```
Miscellaneous\System settings>Date/time
```

The transmitter has a battery-powered clock. Measured values are automatically stored with date and time.

- Select the menu item `Date/time`.

The adjusted time is displayed.

- Enter the current time. For the input of numbers, see section 4.3.
- Press ENTER.

The adjusted date is displayed.

- Enter the current date. For the input of numbers, see section 4.3.
- Press ENTER.

8.6 Information regarding the transmitter

```
Miscellaneous\System settings\Transmitter info
```

- Select the menu item `Transmitter info`.
- Press ENTER.
- Press  to scroll through the list.
- Press BRK to return to the menu item `System settings`.

The following information relating to the transmitter is displayed:

| display | description |
|------------------|--|
| Serial number | serial number of the transmitter |
| Firmware version | version number of the installed firmware |
| Firmware date | creation date of the installed firmware |
| Verification log | state of the verification logger |

9 Measurement

Caution!



Warning of injuries when operating devices with damaged components

The transmitter and the sensor with damaged components must not be used.

- The transmitter and the sensor have to be checked for proper condition and operational safety before each use.
- The housing of the transmitter must always be closed during operation.
- Observe that connection and maintenance work must be concluded.

Caution!



Warning of severe injuries from hot or cold components

Touching hot or cold components can lead to severe injuries (e.g., thermal damage).

- Any mounting, installation or connection work has to be concluded.
- Any work on the measuring point during the measurement is prohibited.
- Observe the ambient conditions at the measuring point during installation.
- Wear the required personal protective equipment.
- Observe the applicable rules.

9.1 Parameter input

Notice!

Avoid a simultaneous parameter entry via the keyboard and the USB, LAN or process interface.
The parameter records received via these interfaces will overwrite the current transmitter parametrization.

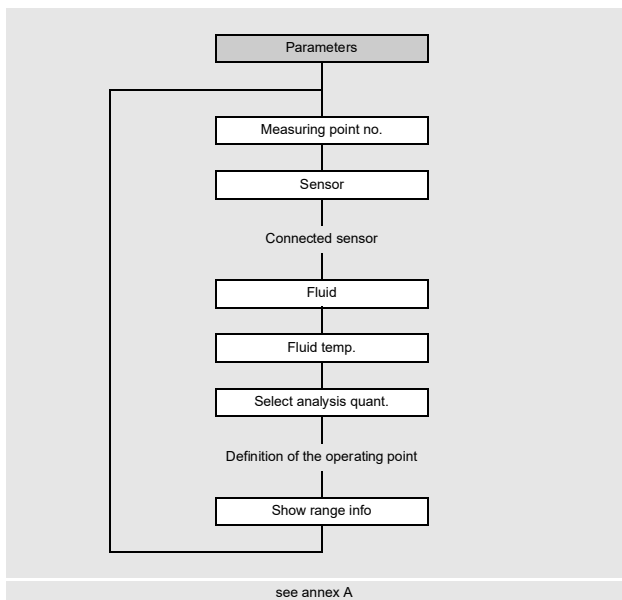

- Select the menu `Parameters`.
- Press ENTER.

9.1.1 Display of the sensor type

Parameters\Connected sensor

The sensor type and the terminal assignment are displayed.

- Press  to scroll through the list.
- Press ENTER.

9.1.2 Input of the measuring point number

Parameters\Measuring point no.

- Enter the number of the measuring point.
- Press ENTER.

For the activation of text input see `Miscellaneous\Dialogs/Menus\Measuring point no.`

9.1.3 Input of fluid parameters

The fluid parameters are entered for the selected measuring point.

Notice!

Customized fluids which are not included in the fluid scroll list can be read via the program FluxDiag. These fluids are displayed in the fluid scroll list with an asterisk.

Notice!

The supplied fluid data remain stored even after an initialization of the transmitter.

Fluid

Parameters\Fluid

- Select the fluid from the scroll list.
- Press ENTER.

If the fluid is not in the scroll list, select the list item `Other fluid`.

Scale

Parameters\Fluid\Other fluid\Scale

- Select the scale (Brix, API) from the scroll list.
- Press ENTER.

This display will only be indicated if `Other fluid` is selected.

Fluid temperature

Parameters\Fluid temp.

- Enter the fluid temperature at the operating point.
- Press ENTER.

9.1.4 Selection of the physical quantity for analysis

A fluid data set consisting of analyte and matrix was developed in the FLEXIM laboratory. This allows to calculate the physical quantity for analysis from the measured refractive index and the fluid temperature.

Tab. 9.1: Physical quantities for analysis

| physical quantity for analysis | display | description | unit of measurement |
|--------------------------------|----------------------|---|---|
| mass fraction | Mass fraction | mass fraction of the analyte in the mixture (weight proportion) | wt% ppm |
| mole fraction | Mole fraction | proportion of the analyte in the mixture (mole fraction, particle fraction) | mol% ppm |
| volume fraction | Volume fraction | volume fraction of the analyte in the mixture | vol% ppm |
| analyte concentration | Analyte concentr. | mass of the analyte per volume of the mixture at reference temperature | g/l |
| matrix concentration | Matrix concentration | mass of the matrix per volume of the mixture at reference temperature | g/l |
| density | Density | density at current fluid temperature (operating density) | kg/m ³ g/cm ³ pounds per gallon |
| standardized density | Norm. density | density at reference temperature (laboratory density, reference density) | kg/m ³ g/cm ³ pounds per gallon |
| normalized refractive index | Norm. refrac. index | refractive index at reference temperature | - |

Notice!

The physical quantity for analysis `Matrix concentration` is only displayed in the menu `Parameters\Select analysis quant.` if a fluid is selected in which analyte and matrix are miscible in any proportion.

Notice!

For the conversion of kg/m³ to g/cm³ and of metric to imperial units, see the menu item `Miscellaneous\Units of measurement.`

`Parameters\Select analysis quant.`

- Select the physical quantity for analysis.
- Press ENTER.

This display will not be indicated if `Other fluid` is selected.

`Parameters\Select analysis quant.\...\OP analysis quantity`

- Enter the operating point for the physical quantity for analysis.
- Press ENTER.

Parameters>Select analysis quant.\...\Show range info

The valid range of the physical quantity for analysis and of the temperature, density and refractive index can be displayed.

- Select **Yes** to display the valid range.
- Press to display the max. and min. values of the valid range.
- Press **ENTER**.

9.1.5 Input of the damping

Parameters\Damping

- Enter the damping factor. Values between 0...100 s are accepted.
- Press **ENTER**.

9.1.6 Input of the error delay

Parameters>Error delay

The error delay is the time interval after which the error value is transmitted to the output.

This display will only be indicated if the list item **Edit** is selected in the menu item **Miscellaneous\Dialogs/Menu\Error delay**.

If no error delay is entered, the damping factor will be used.

- Enter a value for the error delay.
- Press **ENTER**.

9.2 Measurement settings

Swift damping

If **Swift damping** is activated, each displayed measured value is a floating average of the last x seconds, with x being the damping factor. The display thus takes x seconds to fully respond to changes of the measured value.

If **Swift damping** is deactivated, the damping is calculated as first order low-pass filter, i.e. changes of measured values become effective in form of an exponential time course in the measuring result.

Miscellaneous\Measurement settings\Swift damping

- Select the menu item **Swift damping**.
- Select **On** to activate **Swift damping**. Select **Off** to deactivate **Swift damping**.
- Select **Default** (**Swift damping = On**) if no customized inputs are to be made.
- Press **ENTER**.

Input of the reference temperature

Miscellaneous\Measurement settings\Reference temp.

- Enter the temperature for the local reference conditions (default value: 20 °C).
- Press **ENTER**.

Input of the reference pressure

Miscellaneous\Measurement settings\Reference pressure

- Enter the pressure for the local reference conditions (default value: 1 bar).
- Press **ENTER**.

9.3 Units of measurement

Miscellaneous\Unit of measurement

- Select the menu item Miscellaneous\Unit of measurement.

The following units of measurement for the physical quantities can be selected:

- Temperature
- Pressure
- Sound speed
- Density
- Kinematic viscosity

- Select the unit of measurement of the physical quantity.
- Press ENTER.

Notice!

If the physical quantity or the unit of measurement is changed, the settings of the outputs will have to be checked.

9.4 Start of measurement

- Select the menu Start measurement.
- Press ENTER.

The measurement is started.

9.5 Display during the measurement

9.5.1 Measured value

The measured values are displayed during the measurement as follows:

Fig. 9.1: Display of measured values

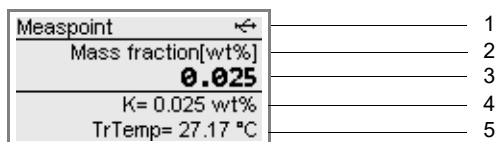

- 1 – menu, status indications
- 2 – physical quantity
- 3 – measured value
- 4 – further physical quantity
- 5 – further physical quantity

By pressing or , additional physical quantities can be displayed during the measurement.

- Press to display the measured values in line 5. The designation of the physical quantity is displayed in line 4 by pressing for several seconds.
- Press to display the measured values in line 4. The designation of the physical quantity is displayed in line 5 by pressing for several seconds.

9.5.2 Parameters

Parameter settings

The parameter settings can be displayed during the measurement.

- Press BRK during the measurement.

The transmitter returns to the main menu.

Fig. 9.2: Display of the main menu during the measurement

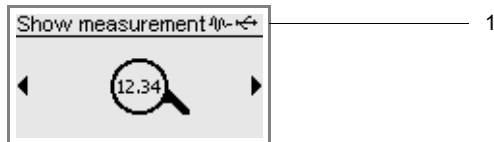

1 – status indication

The measurement is running in the background. The symbol  is displayed in the status indication.

- Press  or CLR to select the corresponding menu to display the parameters.

Notice!

The parameters cannot be changed during the measurement. When attempting to change the parameters, the message `Read-only mode` will be displayed.

The measurement has to be stopped in order to change the parameters.

Information regarding the data logger

Information regarding the data logger can be displayed during the measurement.

- Press  until the following is displayed:

Fig. 9.3: Information regarding the data logger



If the ringbuffer is deactivated, line 4 indicates when the data logger will be full in case all settings are kept.

If the ringbuffer is activated, line 4 indicates how long measurement data can still be stored without losing older measurement data.

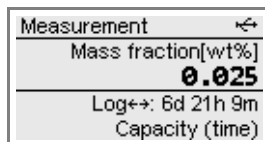
The information regarding the data logger can also be displayed using the function `Show parameters`.

```
Storage\Data logger\Data logger info
```

- Press BRK during the measurement.
- Select the list item `Data logger\Data logger info` in the menu `Storage`.
- Press ENTER.

The information regarding the data logger is displayed.

9.5.3 Change to the display of measured values

- Press and hold BRK to return to the main menu.
- Select the menu `Show measurement`.
- Press ENTER.

The measured values are displayed.

9.6 Stop of measurement

- Press and hold BRK to return to the main menu.
- Select the menu `Stop measurement`.

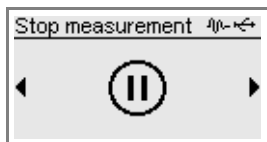

- Press ENTER.
- Select `Yes` to stop the measurement.
- Press ENTER.

The measurement is stopped. The main menu will be displayed.

10 Troubleshooting

Warning!



Service works by unauthorized and unqualified personnel

This may result in personal or material damage or dangerous situations.

→ Any work on the transmitter has to be carried out by authorized and qualified personnel.

Caution!



Safety and accident prevention regulations for electrical systems and equipment

Failure to observe these regulations may lead to severe injuries.

→ Observe the safety and accident prevention regulations for electrical systems and equipment.

Warning!



Touching live parts

Electric shock or arc faults can lead to severe injuries. The measuring equipment can be damaged.

→ Prior to any work on the transmitter (e.g., installation, dismantling, connection, start-up), the transmitter has to be disconnected from the power supply. It is not sufficient to remove the internal fuse of the instrument.

Caution!



Touching hot or cold surfaces

This may result in injuries (e.g., thermal damages).

- Observe the ambient conditions at the measuring point during installation.
- Wear the required personal protective equipment.
- Observe the applicable rules.

If any problem appears which cannot be solved with the help of this operating instruction, contact our sales office and give a precise description of the problem. Specify the type, the serial number and the firmware version of the transmitter.

The display does not work at all or fails regularly.

- Check the contrast setting of the transmitter or enter the HotCode **555000** to set the display to medium contrast.
- Make sure that the correct voltage is available at the terminals. The destined transmitter voltage is indicated on the nameplate below the outer right terminal strip.
- If the power supply is OK, the sensor or an internal component of the transmitter is defective. The sensor and the transmitter have to be sent to FLEXIM for repair.
- If the transmitter is only connected via the USB interface, the backlight will be switched off.

An error is displayed in the status indication (symbol .

- Press BRK to return to the main menu.
- Select the menu item `Storage\Event log`.
- Press ENTER.

The error message list will be displayed.

An output does not work.

- Make sure that the outputs are configured correctly. Check the function of the output. If the output is defective, contact FLEXIM.

10.1 Problems with the measurement

A measurement is not possible because no signal is received. An interrogation point is displayed after the physical quantity. The LED lights red after starting the measurement.

- Make sure the sensor is correctly connected to the transmitter. The sensor must be recognized by the transmitter. The serial number of the sensor will be displayed (see menu item `Parameters\Connected transd.`).

The signal is lost during the measurement.

- If there is no measuring signal after the pipe had been run empty and refilled, contact FLEXIM.
- Make sure the pipe is filled with the fluid and the sensor head is completely submerged into the fluid. The sensor can only measure within the fluid, otherwise the measurement becomes invalid. The measurement can be interrupted due to a temporarily higher proportion of gas bubbles and solids in the fluid.
- The sensor functions according to the transmitted light principle. A turbid fluid and contaminated measurement optics can attenuate the light to such an extent that the measuring signal is invalid. Check the measurement optics for contamination.

10.2 Measuring point selection

- Avoid measuring points with deposit formation in the pipe.
- When measuring on a horizontal pipe, the sensor has to be mounted laterally on the pipe.
- A vertical pipe always has to be filled at the measuring point and the fluid should flow upward.
- No gas bubbles should form (even bubble-free fluids can form gas bubbles when the fluid expands, e.g., upstream of pumps and downstream of great cross-section enlargements).

10.3 Application-specific problems

The measuring points of the physical quantities for analysis are outside the valid range

- Check the entered value.

Turbid signals scatter the optical signal

- The measurement of fluids with a turbidity > 10000 FAU (Formazine Attenuation Units) becomes invalid.

Gas bubbles or solids present in high concentration in the fluid scatter and absorb the optical signal and thus attenuate the measuring signal

11 Maintenance and cleaning

Warning!



Service works by unauthorized and unqualified personnel
This may result in personal or material damage or dangerous situations.
→ Any work on the transmitter has to be carried out by authorized and qualified personnel.

Warning!



Touching live parts
Electric shock or arc faults can lead to severe injuries. The measuring equipment can be damaged.
→ Prior to any work on the transmitter (e.g., installation, dismantling, connection, start-up), the transmitter has to be disconnected from the power supply. It is not sufficient to remove the internal fuse of the instrument.

Caution!



Safety and accident prevention regulations for electrical systems and equipment
Failure to observe these regulations may lead to severe injuries.
→ Observe the safety and accident prevention regulations for electrical systems and equipment.

Caution!



Touching hot or cold surfaces
This may result in injuries (e.g., thermal damages).
→ Observe the ambient conditions at the measuring point during installation.
→ Wear the required personal protective equipment.
→ Observe the applicable rules.

11.1 Maintenance

The transmitter and the sensor are practically maintenance-free. In order to ensure security, the following maintenance intervals are recommended:

Tab. 11.1: Recommended maintenance intervals

| item | maintenance step | interval | measure |
|-------------|--|--|---|
| transmitter | • visual inspection for corrosion, damages and contamination | annually or more frequently, depending on the ambient conditions | cleaning |
| | • firmware check for updates | annually | update, if necessary |
| | • functional test | annually | reading of measured and diagnostic values |
| sensor | • dismantling and visual inspection of the O-rings and measurement optics for corrosion, damages and contamination | annually or more frequently, depending on the ambient conditions | cleaning, change of O-rings, if necessary |
| | • functional test | annually | reading of measured and diagnostic values |

11.2 Cleaning

Generally, the regular process cleaning and rinsing cycles are sufficient to keep the optical surfaces of the measuring prism and window clean. However, depending on the measured fluid, it can be necessary to clean the measuring prism or window to avoid the formation of deposits.

For manual cleaning the sensor is dismantled and cleaned with a cloth (see Fig. 11.1).

Important!

Do not use aluminous abrasives when cleaning the measuring prism and window.

Notice!

When using aggressive detergents observe the chemical resistance of the corresponding parts.

Fig. 11.1: Cleaning of measuring prism and window



12 Dismounting and disposal

Warning!



Installation, connection and start-up by unauthorized and unqualified personnel

This may result in personal or material damage or dangerous situations.

→ Any work on the transmitter has to be carried out by authorized and qualified personnel.

Warning!



Touching live parts

Electric shock or arc faults can lead to severe injuries. The measuring equipment can be damaged.

→ Prior to any work on the transmitter (e.g., installation, dismantling, connection, start-up), the transmitter has to be disconnected from the power supply. It is not sufficient to remove the internal fuse of the instrument.

Caution!



Safety and accident prevention regulations for electrical systems and equipment

Failure to observe these regulations may lead to severe injuries.

→ Observe the safety and accident prevention regulations for electrical systems and equipment.

12.1 Dismounting

Dismounting is carried out in reverse order to the installation.

12.2 Disposal

The measuring equipment has to be disposed of in accordance with the applicable regulations.

Important!

Proper disposal of components of the transmitter and accessories that are no longer required avoids environmental damage and conserves resources.

Depending on the material, the corresponding parts have to be disposed of in residual or special waste or recycled in accordance with the applicable regulations.

Batteries must be disposed of separately from electrical or electronic equipment.

For this purpose, remove the batteries from the device and take them to the designated disposal system.

The components are taken back free of charge by FLEXIM in accordance with national regulations. Contact FLEXIM.

13 Outputs

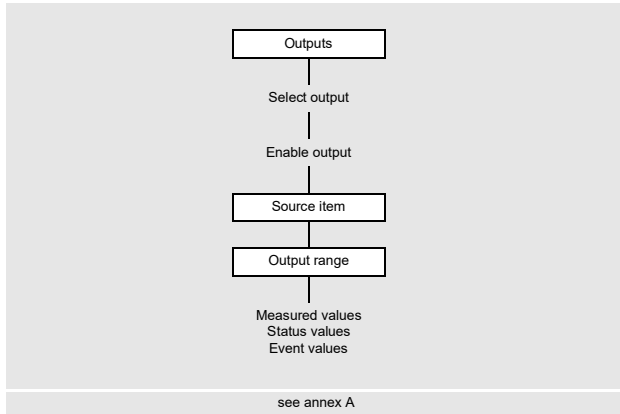

13.1 Analog output

If the transmitter is equipped with outputs, they have to be configured. In principle, the measured value, the status value or an event value can be transmitted via the different outputs.

- Select the menu `Outputs`.
- Press ENTER.

```
Outputs\Current I1(--)
```

- Select the output to be configured.
The scroll list contains all available outputs.
- Press ENTER.

13.1.1 Enabling an output

If the output has to be used, it has to be enabled (here: `Current I1`)

```
Outputs\Current I1(--)
```

- Select the output `Current Ix (--)`.
- Press ENTER.

If the output has already been enabled, it is displayed as follows: `Current I1 (√)`.

```
Outputs\Current I1\I1 Enable
```

- Select `Yes` to enable an output or change the settings for an already enabled output.
- Select `No` to cancel the enabling and to return to the previous menu item.
- Press ENTER.

13.1.2 Assignment of a source item

One source item has to be assigned to each selected output.

```
Outputs\...\Source item
```

- Select a source item whose measured value, status value or event value is to be transmitted to the output.
- Press ENTER.

Tab. 13.1: Configuration of the outputs

| source item | list item | output |
|------------------|-------------------------------------|---|
| Refractometer | Symmetry | diagnostic values |
| | Gain | |
| | Amplitude | |
| | Quality | |
| | SNR | |
| Sensor | Sensor humidity Transducer temp. | sensor values |
| Analysis | Mass fraction | physical quantity for analysis selected in the menu <code>Parameters</code> |
| | Brix scale | |
| Fluid properties | Fluid temp. | |
| | Fluid density | |
| | Norm. density | |
| Event trigger | R1 | limit message (Event trigger R1) |
| | R2 | limit message (Event trigger R2) |
| | R3 | limit message (Event trigger R3) |
| | R4 | limit message (Event trigger R4) |
| Miscellaneous | Custom. Input 1 | If a fieldbus is connected, input quantities (e.g., sound speed, density) which are not used for calculation can be assigned as source item. For the connection of the fieldbuses to the transmitter, see supplement to operating instruction. |
| | Custom. Input 2 | |
| | Custom. Input 3 | |
| | Custom. Input 4 | |
| Refractive index | Refractive index | |
| | Norm. refrac. index | |
| | Refractive index (Δ) | |

Depending on the selected source item, it is possible to output measured values, status values or event values.

Tab. 13.2: Output of measured values, status values or event values

| | source item | measured value | | event value |
|---------------------|------------------|----------------|--------|-------------|
| | | value | status | |
| physical quantities | Refractometer | X | X | - |
| | Analysis | X | X | - |
| | Fluid properties | X | X | - |
| | Miscellaneous | X | X | - |
| | Refractive index | X | X | - |
| events | Event trigger | - | - | X |

13.1.3 Output of a measured value

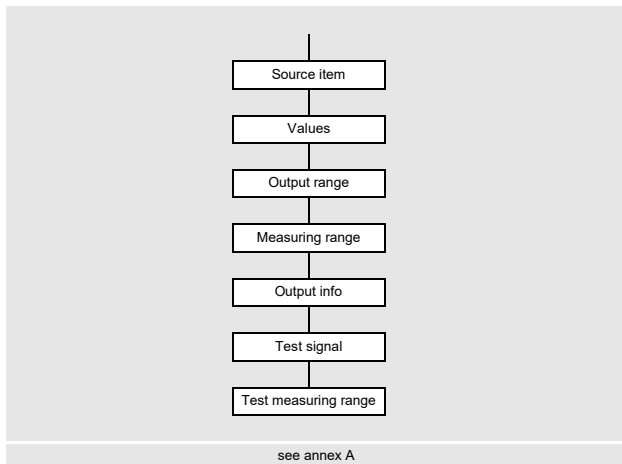

Output range

- Select `Values` in the menu item `Source item`.
- Press `ENTER`.

`Outputs\...\Output range`

- Select a list item.
 - `4...20 mA`
 - `Other range`

- Press `ENTER`.

If `Other range` is selected, enter the values `Output MIN` and `Output MAX`.

The output range has to be > 10 % of the max. output value (`Output MAX`).

If the output range is smaller, an error message will be displayed.

The next possible value will be displayed.

- Repeat the input.

Error output

`Outputs\...\Error value`

An error value can be defined which is output if the source item cannot be measured.

- Select a list item for the error output.
- Press `ENTER`.
- If `Other value` is selected, enter an error value. The value has to be outside the output range.
- Press `ENTER`.

Example

source item: normalized refractive index n_D
 output: current
 output range: `4...20 mA`
 error delay: $t_d > 0$

The normalized refractive index n_D cannot be measured during the time interval $t_0...t_1$. The error value will be output.

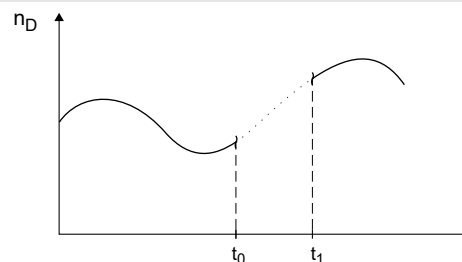

Tab. 13.3: Examples for the error output (output range: 4...20 mA)

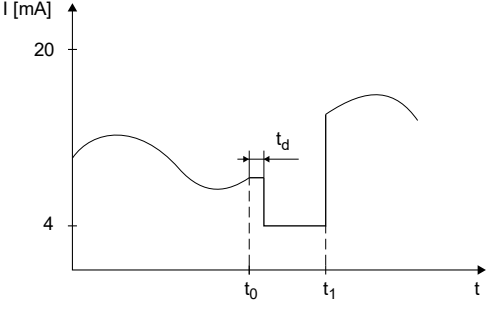
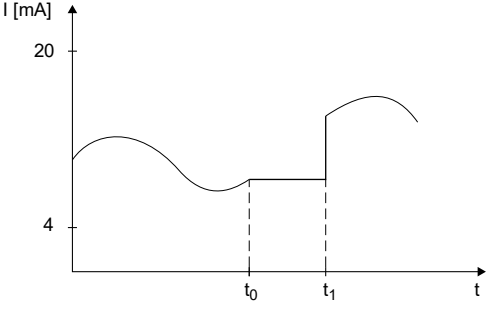
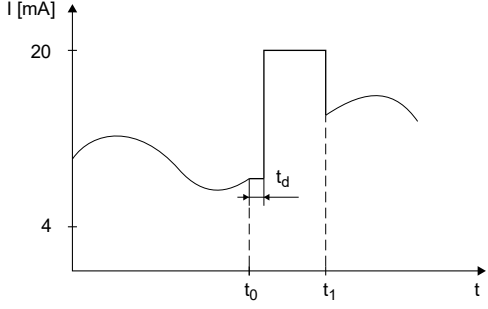
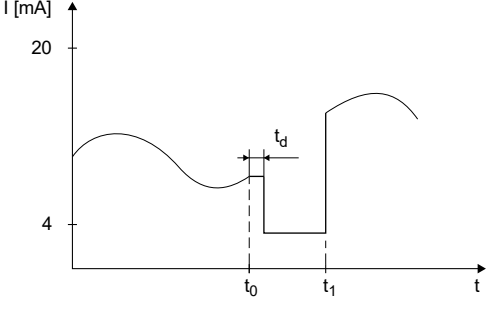
| list item | output signal |
|-------------------------------------|--|
| Minimum (4.0 mA) |  |
| Last value |  |
| Maximum (20.0 mA) |  |
| Other value error value = 3.5 mA |  |

Measuring range

The measuring range is defined.

```
Outputs\...\Start of meas. range
```

- Enter the lowest expected measured value. The unit of measurement of the source item will be displayed.

Start of meas. range is the value assigned to the value Output MIN of the output range.

```
Outputs\...\End of meas. range
```

- Enter the highest expected measured value. The unit of measurement of the source item will be displayed.

End of meas. range is the value assigned to the value Output MAX of the output range.

Terminal assignment

```
Outputs\...\Output info
```

The terminals for the connection of the output are displayed.

By pressing  or  further information is displayed.

- Press ENTER.

Output function test

The function of the output can now be tested.

- Connect an external measuring instrument to the terminals of the output.

```
Outputs\...\Test signal
```

- Select Yes to test the output. Select No to display the next menu item.

- Press ENTER.

```
Outputs\...\Enter test value
```

- Enter a test value. It has to be within the output range.

- Press ENTER.

If the external measuring instrument displays the entered value, the output functions correctly.

- Select Repeat to repeat the test, Finish to display the next menu item.

- Press ENTER.

```
Outputs\...\Test measuring range
```

- Select Yes to test the assignment of the measured value to the output signal. Select No to display the next menu item.

- Press ENTER.

```
Outputs\...\Enter test value
```

- Enter a test value. It has to be within the expected measuring range.

- Press ENTER.

If the external measuring instrument displays the corresponding current value, the output functions correctly.

- Select Repeat to repeat the test or Finish to display the next menu item.

- Press ENTER.

13.1.4 Output of a status/event value

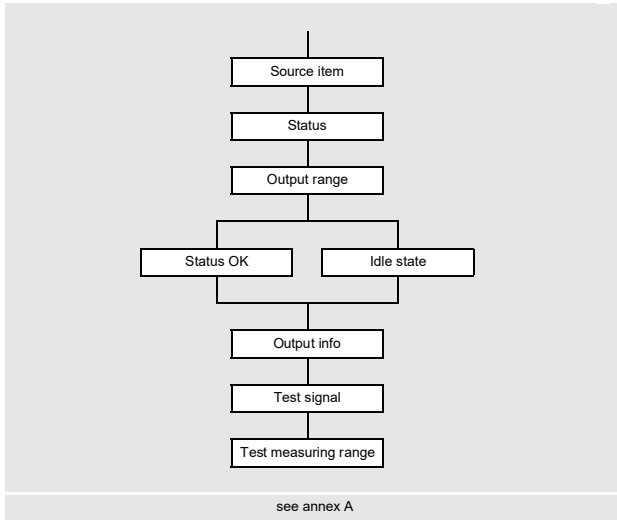

- Select `Status` in the menu item `Source item`.
- Press `ENTER`.

Output range

```
Outputs\...\Output range
```

- Select a list item.
 - `4...20 mA`
 - `Other range`
 - Press `ENTER`.
- If `Other range` is selected, enter the values `Output MIN` and `Output MAX`.

The output range has to be > 10 % of the max. output value (`Output MAX`). If the output range is smaller, an error message will be displayed. The next possible value will be displayed.

| status value – status OK | event value – idle state |
|---|---|
| The status of the output signal is defined which is to be output when measuring a measured value. | The status of the output signal is defined which is to be output if no event occurs. |
| <ul style="list-style-type: none"> • Select the value for status OK from the scroll list. • Press <code>ENTER</code>. | <ul style="list-style-type: none"> • Select the value for the idle state. • Press <code>ENTER</code>. |

Terminal assignment

```
Outputs\...\Output info
```

The terminals for the connection of the output are displayed.

By pressing or further information is displayed.

- Press `ENTER`.

Output function test

The function of the output can now be tested.

- Connect an external measuring instrument to the terminals of the output.

```
Outputs\...\Test signal
```

- Select `Yes` to test the output. Select `No` to display the next menu item.
- Press `ENTER`.

```
Outputs\...\Enter test value
```

- Enter a test value. It has to be within the output range.
- Press `ENTER`.

If the external measuring instrument displays the entered value, the output functions correctly.

- Select `Repeat` to repeat the test, `Finish` to display the next menu item.
- Press `ENTER`.

Outputs\...\Test measuring range

- Select **Yes** to test the assignment of the measured value to the output signal. Select **No** to display the next menu item.
- Press **ENTER**.

Outputs\...\Enter test value

- Select a list item as test value.
- Press **ENTER**.

| status value | event value |
|--|--|
| Status OK or Status error. If the external measuring instrument displays the value (min. output value for Status error, max. output value for Status OK), the output functions correctly. | Active or Passive. If the external measuring instrument displays the value (min. output value for Passive, max. output value for Active), the output functions correctly. |

- Select **Repeat** to repeat the test. Select **Finish** to display the next menu item.
- Press **ENTER**.

13.2 Digital output

The transmitter can also be equipped with digital outputs. A digital output combines the functions of the following outputs:

- binary output (output of binary switching conditions)
- pulse output (integrating output of quantities)
- frequency output (scaled output of flow quantities)

These functions depend on the selected physical quantity.

Tab. 13.4: Output via digital outputs

| | source item | binary output | | pulse output | frequency output |
|---------------------|-------------------|---------------|-------------|--------------|------------------|
| | | status value | event value | | |
| physical quantities | Refractometer | x | | | |
| | Analysis | x | | | |
| | Pulse | | | x | |
| | Fluid properties | x | | | x |
| | Diagnostic values | | | | x |
| | Miscellaneous | x | | | x |
| | Refractive index | x | | | |
| events | Event trigger | | x | | |

13.2.1 Configuration of a digital output as binary output

A binary output switches if one of the following switching conditions is met:

- the measured value exceeds or falls below a limit
- the measured value lays within or outside a defined range
- a measurement is not possible
- an event occurs
- Select the menu `Outputs`.
- Press ENTER.

`Outputs\Binary B1\Enable B1`

- Select `Yes` to change the settings for an assigned output or to assign a new output.
- Select `No` to cancel the assignment and to return to the previous menu item.
- Press ENTER.

Assignment of a source item

`Outputs\...\Source item`

Depending on the selected source item, status or event values can be output.

Tab. 13.5: Output of status values and event values

| | source item | status value | event value |
|---------------------|------------------|--------------|-------------|
| physical quantities | Refractometer | X | |
| | Analysis | X | |
| | Fluid properties | X | |
| | Miscellaneous | X | |
| | Refractive index | X | |
| events | Event trigger | | X |

- Select the source item.
- Press ENTER.

13.2.1.1 Definition of the switching function for the status/event value

- Select the switching function for the output of the status/event value.
- Press ENTER.

Tab. 13.6: Selection of the switching condition



| property | switching function | description |
|-----------------------------|--------------------|--|
| Status OK (status value) | NC | <ul style="list-style-type: none"> • valid measured value: binary output is closed • invalid measured value: binary output is open |
| | NO | <ul style="list-style-type: none"> • valid measured value: binary output is open • invalid measured value: binary output is closed |
| Idle state (event value) | NO | <ul style="list-style-type: none"> • event occurs: binary output is closed • event has not occurred yet: binary output is open |
| | NC | <ul style="list-style-type: none"> • event occurs: binary output is open • event has not occurred yet: binary output is closed |

If no measurement is carried out, all binary outputs are open (de-energized), independent of the set switching condition.

Terminal assignment

```
Outputs\...\Output info
```

The terminals for the connection of the output are displayed.

By pressing  or  further information is displayed.

- Press ENTER.

Output function test

The function of the output can now be tested.

- Connect a multimeter to the output.

```
Outputs\...\B1 Test signal
```

- Select **Yes** to test the output. Select **No** to display the next menu item.
- Press ENTER.

```
Outputs\...\B1 Enter test value
```

- Select a list item as test value.
- Press ENTER.

Tab. 13.7: Output function test – signal

| list item | description |
|-----------|---|
| NC | <ul style="list-style-type: none">• binary output is energized• measured value has to be low ohmic |
| NO | <ul style="list-style-type: none">• binary output is de-energized• measured value has to be high ohmic |

- Select **Repeat** to repeat the test or **Finish** to display the next menu item.
- Press ENTER.

```
Outputs\...\B1 Test measuring range
```

- Select **Yes** to test the status of the output signal. Select **No** to display the next menu item.
- Press ENTER.

```
Outputs\...\B1 Enter test value
```

- Select a list item as test value.
- Press ENTER.

Tab. 13.8: Output function test – measuring range

| list item | switching function | test value | description |
|-----------------------------|--------------------|--------------|--|
| Status OK (status value) | NC | Status OK | <ul style="list-style-type: none"> • binary output is energized • measured value has to be low ohmic |
| | | Status error | <ul style="list-style-type: none"> • binary output is de-energized • measured value has to be high ohmic |
| | NO | Status OK | <ul style="list-style-type: none"> • binary output is de-energized • measured value has to be high ohmic |
| | | Status error | <ul style="list-style-type: none"> • binary output is energized • measured value has to be low ohmic |
| Idle state (event value) | NC | Passive | <ul style="list-style-type: none"> • binary output is energized • measured value has to be low ohmic |
| | | Active | <ul style="list-style-type: none"> • binary output is de-energized • measured value has to be high ohmic |
| | NO | Passive | <ul style="list-style-type: none"> • binary output is de-energized • measured value has to be high ohmic |
| | | Active | <ul style="list-style-type: none"> • binary output is energized • measured value has to be low ohmic |

- Select Repeat to repeat the test or Finish to display the next menu item.
- Press ENTER.

13.2.2 Configuration of a digital output as pulse output

A pulse output is an integrating output which emits a pulse when the volume or the mass of the fluid which has passed the measuring point reaches a certain value (pulse value).

The integrated quantity is the selected physical quantity. The integration is restarted as soon as the pulse is emitted. Before the activation, the digital output has to be configured.

Outputs\Digital output B1\Source item

- Select the menu item Outputs\Digital output B1\Source item.
- Press ENTER.

Assignment of a source item

Outputs\Source item\Pulse

- Select Pulse as source item.
- Press ENTER.

Outputs\Pulse\Pulse +V

- Select a list item (here: Pulse +V).
- Press ENTER.

Tab. 13.9: Selection of the physical quantity

| source item | list item | output |
|-------------|-----------|--|
| Pulse | Pulse V | pulse without considering the sign of the volumetric flow rate |
| | Pulse +V | pulse for positive measured values of the volumetric flow rate |
| | Pulse -V | pulse for negative measured values of the volumetric flow rate |
| | Pulse m | pulse without considering the sign of the mass flow rate |
| | Pulse +m | pulse for the positive measured values of the mass flow rate |
| | Pulse -m | pulse for the negative measured values of the mas flow rate |

13.2.2.1 Pulse output by defining the pulse value

Outputs\Pulse output

- Select the list item `Pulse value`.
- Press ENTER.

The pulse output can be operated in 2 modes:

| mode | description |
|-------------------|---|
| Continuous pulses | <ul style="list-style-type: none"> • output of a continuous pulse sequence, reproducing the temporal behavior of the corresponding flow quantity (volumetric flow rate, mass flow rate), with simultaneous totalizing • smallest pulse break = pulse width at max. pulse rate (pulse width is constant) |
| Burst pulses | <ul style="list-style-type: none"> • output of a discontinuous pulse sequence, reproducing the behavior of the totalizer • several pulses can arise intermittently with equidistant pulse distances (pulse break = pulse width) • serves exclusively for totalizing • max. pulse rate (depends on the pulse width that is constant) |

- Select a list item.
- Press ENTER.

Outputs\Pulse value

- Enter the pulse value.

The unit of measurement will be displayed according to the actual physical quantity.

When the counted physical quantity reaches the entered pulse value, a pulse will be transmitted.

- Press ENTER.

Outputs\Pulse width

- Enter the pulse width.

The range of possible pulse widths depends on the specification of the instrument (e.g., counter, PLC) that is to be connected to the output.

- Press ENTER.

13.2.2.2 Pulse output by defining pulses per unit

Outputs\Pulse output

- Select the list item `Pulses per unit`.
- Press ENTER.

Outputs\Output range

- Select a list item:
 - 0...1 kHz
 - 0...5 kHz
 - Other range

- Press ENTER.

If `Other range` is selected, enter a value for `Output MAX`.

Outputs\Pulses per unit

- Enter the number of pulses per unit.
- Press ENTER.

The unit of measurement will be displayed according to the actual physical quantity.

13.2.2.3 Output options

Outputs\Idle state

- Select the setting of the idle state:

| setting | description |
|---------|---|
| NO | The pulse output is energized if a pulse is emitted and de-energized if no pulse is emitted (idle state). |
| NC | The pulse output is de-energized if a pulse is emitted and energized if no pulse is emitted (idle state). |

If no measurement is carried out, all pulse outputs are open (de-energized), independent of the set switching condition.

Terminal assignment

Outputs\...\Output info

The terminals for the connection of the output are displayed.

By pressing  or  further information is displayed.

- Press ENTER.

Output function test

Outputs\...\B1 Test signal

- Select *Yes* to test the status of the output signal. Select *No* to display the next menu item.
- Press ENTER.

Outputs\...\B1 Enter test value

- Select a list item as test value.
- Press ENTER.

Tab. 13.10: Output function test – signal

| output mode | test value | description |
|-----------------|---|---|
| Pulses per unit | The entered test value has to be within the output range. | If the external measuring instrument displays the entered value, the output functions correctly. |
| Pulse value | NO | <ul style="list-style-type: none"> • pulse output is de-energized • measured value has to be high ohmic |
| | NC | <ul style="list-style-type: none"> • pulse output is energized • measured value has to be low ohmic |

13.2.3 Configuration of a digital output as frequency output

The frequency output emits a square wave signal with a frequency which is proportional to the measured value of the source item sent to the output.

Outputs\Digital output B1\Source item

- Select the menu item *Outputs\Digital output B1\Source item*.
- Press ENTER.

Assignment of a source item

- Select one of the following source items:
 - Analysis
 - Fluid properties
 - Event trigger
 - Miscellaneous
 - Refractive index
 - Refractometer

Outputs\Flow quantities

- Select a list item (here: *Fluid properties*).
- Press ENTER.

Outputs\Volumetric flow rate

- Select a list item (here: *Fluid temp.*).
- Press ENTER.
- Select the list item *Values*.
- Press ENTER.

Output range

```
Outputs\...\Output range
```

- Select a list item.

- 0...1 kHz
- 0...10 kHz
- Other range

- Press ENTER.

If `Other range` is selected, enter the values `Output MIN` and `Output MAX`.

Error output

```
Outputs\...\Error value
```

An error value can be defined which is output if the source item cannot be measured.

- Select a list item for the error output.
- Press ENTER.

Measuring range

The sign of the measured value and the measuring range are determined.

```
Outputs\...\Measured values\Absolute value
```

- Select `Sign` if the sign of the measured values is to be considered for the output.
- Select `Absolute value` if the sign of the measured values is not to be considered for the output.

```
Outputs\...\Start of meas. range
```

- Enter the lowest expected measured value. The unit of measurement of the source item will be displayed.
- `Start of meas. range` is the value assigned to the value `Output MIN` of the output range.

```
Outputs\...\End of meas. range
```

- Enter the highest expected measured value. The unit of measurement of the source item will be displayed.
- `End of meas. range` is the value assigned to the value `Output MAX` of the output range.

Idle state

The idle state is the status of the output signal to be output when no measured value is measured.

- Select a list item for the idle state.
- Press ENTER.

Terminal assignment

```
Outputs\...\Output info
```

The terminals for the connection of the output are displayed.

By pressing  or  further information is displayed.

- Press ENTER.

Output function test

The function of the output can now be tested.

- Connect an external measuring instrument to the terminals of the installed output.

```
Outputs\...\Test signal
```

- Select **Yes** to test the output. Select **No** to display the next menu item.
- Press **ENTER**.

```
Outputs\...\Enter test value
```

- Enter a test value. It has to be within the output range.
- Press **ENTER**.

If the external measuring instrument displays the entered value, the output functions correctly.

- Select **Repeat** to repeat the test or **Finish** to display the next menu item.
- Press **ENTER**.

```
Outputs\...\Test measuring range
```

- Select **Yes** to test the assignment of the measured value to the output signal. Select **No** to display the next menu item.
- Press **ENTER**.

```
Outputs\...\Enter test value
```

- Enter a test value. It has to be within the output range.
- Press **ENTER**.

If the external measuring instrument displays the entered value, the output functions correctly.

- Select **Repeat** to repeat the test and **Finish** to finish it.
- Press **ENTER**.

14 Data logger

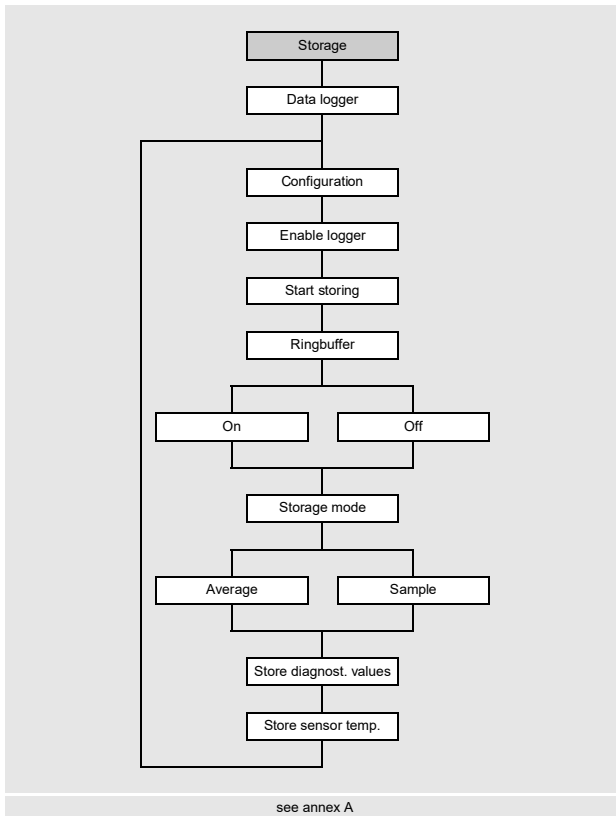

The transmitter has a data logger which stores the measured values during the measurement.

Notice!

In order to store measured data, the data logger has to be configured.

The following data is stored within the data logger:

- date
- time
- measuring point number
- fluid parameters
- sensor data
- physical quantity
- unit of measurement
- measured value

Measured values transmitted via the outputs are also stored in the data logger.

14.1 Configuration of the data logger

Enabling the data logger

```
Storage\Data logger\Configuration\Enable logger
```

- Select the menu item `Data logger\Configuration` in the menu `Storage`.
- Press ENTER.
- Select `Yes` to enable the data logger.
- Press ENTER.

Starting time

```
Storage\Data logger\Configuration\Start storing
```

It is possible to set a starting time if it is necessary to synchronize the storing of measured values for several transmitters.

- Select the menu item `Storage\Data logger\Configuration`.
- Press ENTER until the menu item `Start storing` is displayed.
- Select the moment at which to start the storing.
- Press ENTER.

| display | description |
|-----------------|---|
| Immediately | The storing starts immediately. |
| Full 5 minutes | The storing starts in the next full 5 minutes. |
| Full 10 minutes | The storing starts in the next full 10 minutes. |
| Full 15 minutes | The storing starts in the next full 15 minutes. |
| Full 30 minutes | The storing starts in the next full 30 minutes. |
| Full hour | The storing starts in the next full 60 minutes. |
| Event-based | The storing starts when a defined event occurs. |

Example

actual time: 09:06 am
 setting: Full 10 minutes
 The storing starts at 09:10 am.

Notice!

Make sure that the time of all transmitters is synchronized.

Event-based starting time

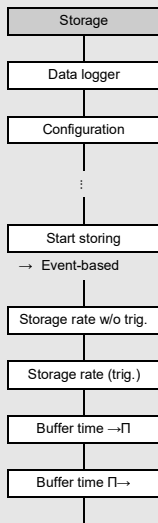

see annex A

```
Storage\Data logger\Configuration\
Start storing\Event-based
```

If it is necessary to start the storing of measured values at a particular event, select the list item *Event-based* as starting time.

The event is signaled via an event trigger. All configured event triggers are displayed in the scroll list.

- Select the event trigger through which the event is to be signaled.
- Press ENTER.

```
Storage\Data logger\Configuration\Start storing\Event-based\Storage rate w/o trig.
```

The storage rate is the frequency to transmit or store measured values.

- Select in the scroll list a storage rate for storing the measured values in case the event does not occur.
- Press ENTER.
- Select *Off* if no measured values are to be stored, as long as the event does not occur.
- Press ENTER.

```
Storage\Data logger\Configuration\Start storing\Event-based\Storage rate (trig.)
```

- Select in the scroll list a storage rate for storing the measured values in case the event occurs.
- Press ENTER.

```
Storage\Data logger\Configuration\Start storing\Event-based\Buffer time ->Π
```

- Enter the time interval for the measured values to be stored before the event occurs.
- Press ENTER.

```
Storage\Data logger\Configuration\Start storing\Event-based\Buffer time Π->
```

- Enter the time interval for the measured values to be stored if the event is no longer activated.
- Press ENTER.

Storage rate

```
Storage\Data logger\Configuration\Storage rate
```

The storage rate is the frequency to transmit or store measured values. If a start time for storing the measured values is defined, a storage rate has to be entered.

- Select the menu item `Storage\Data logger\Configuration`.
- Press ENTER until the menu item `Storage rate` is displayed.
- Select a storage rate from the scroll list.
- Press ENTER.
- If `Customized` is selected, enter the storage rate.
- Press ENTER.

Ringbuffer

```
Storage\Data logger\Configuration\Ringbuffer
```

The data logger can be configured as linear logger or ringbuffer. If the ringbuffer is deactivated and the data logger is full, the storing of measured values will be terminated. It can be continued after clearing the data logger. If the ringbuffer is activated and the data logger is full, the oldest measured values will be overwritten. In ringbuffer mode, the remaining capacity of the data logger is displayed during the measurement, e.g.:

Log→ : 1d 6h 57m is displayed, if no measured values have been overwritten.

Log|↔| : 1d 6h 57m is displayed, if the old measured values have been overwritten.

- Select the menu item `Storage\Data logger\Configuration`.
- Press ENTER until the menu item `Ringbuffer` is displayed.
- Select `On` to activate the ringbuffer.
- Press ENTER.

If the ringbuffer is deactivated and the data logger is full, the storing of measured values will be terminated.

- Select `Off` to deactivate the ringbuffer.
- Press ENTER.

Storage mode

Storage\Data logger\Configuration\Storage mode

- Select the menu item Storage\Data logger\Configuration.
- Press ENTER until the menu item Storage mode is displayed.
- Press ENTER.
- Select Sample to store the current measured value.
- Select Average if the average of all undamped measured values of a storage interval is to be stored.

Notice!

The storage mode does not affect the outputs.

Notice!

Storage mode = Average

The average of the physical quantity and of other quantities, e.g., the measured temperature, will be calculated.

If a storage rate < 5 s is selected, Sample is used.

If no average could be calculated over the complete storage interval, the value is marked as invalid.

Further parameters for storing

It can be defined whether the following parameters are to be stored together with the measured values.

Tab. 14.1: Parameters for storing

| display | description of the parameters |
|------------------------|-------------------------------|
| Store diagnost. values | diagnostic values |
| Store sensor temp. | sensor temperature |

- Select Yes to store the value. Select No in order not to store the value.

14.2 Deletion of the data logger

Storage\Data logger>Delete meas. values

- Select the menu item Storage\Data logger>Delete meas. values.
- Press ENTER.
- Select Yes to delete the measured values.
- Press ENTER.

14.3 Information regarding the data logger

Storage\Data logger\Data logger info

- Select the menu item Storage\Data logger\Data logger info.
- Press ENTER.

The following information regarding the data logger is displayed:

| display | description |
|-------------------|--|
| Activated | data logger is activated/deactivated This display will only be indicated if the measurement has started and the data logger is activated. |
| Full (date) | date on which the data logger will be full This display will only be indicated if the measurement has started and the ringbuffer is deactivated. |
| Full (time) | time at which the data logger will be full This display will only be indicated if the measurement has started, the ringbuffer is deactivated and the data logger is not full yet. |
| Overflow (date) | date from which the oldest measured values will be overwritten This display will only be indicated if the measurement has started, the ringbuffer is activated and the data logger is not full yet. |
| Capacity (time) | time of remaining data logger capacity This display will only be indicated if the measurement has started and the ringbuffer is activated. |
| Ringbuffer | ringbuffer is activated/deactivated |
| Meas. val. Series | number of stored series of measured values |

15 Data transmission

15.1 Service interfaces

The service interfaces (USB, LAN) allow data to be transmitted from the transmitter to the PC using the FluxDiagReader program. The following tasks can be carried out:

- read and store measured values and setup settings
- graphically display measured values
- export data in csv format

For the operation of FluxDiagReader see the help function of this program.

15.1.1 LAN interface

In order to use the LAN interface it is important to adapt the network parameters. The transmitter supports the internet protocol versions 4 and 6.

Communication\Network

- Select the list item `Network` in the menu item `Communication`.
- Press ENTER.

15.1.1.1 Internet protocol version 6

The transmitter uses the automatic address configuration (SLAAC) to generate 2 individual IPv6 addresses allowing it to be reached in the network.

- link-local address with the prefix "FE80::/64"
With this address, the transmitter can only be reached within its own network segment.
- global address
With this address, the transmitter can be reached worldwide.

- Select the list item `IPv6` to display these IPv6 addresses.
- Press ENTER.

The IPv6 addresses are displayed.

15.1.1.2 Internet protocol version 4

- If the network parameters for IPv4 are to be adjusted, select the list item `IPv4`.
- Press ENTER.

Manual input

- Select `Manual` to enter the network parameters (IP address, subnet mask and standard gateway).

Notice!

The entered network parameters have to accord with the LAN parameters.

Default values in the transmitter:

- IP address: 192.168.0.70
- subnet mask: 255.255.255.0
- standard gateway: 192.168.0.1

Automatic addressing with DHCP

- Select `Automatic` to automatically identify the network parameters (IP address, subnet mask and standard gateway) via a DHCP server.

Notice!

The network parameters can only be automatically identified if the LAN supports DCHP.

- Select the menu item `Communication\Network\IPv4>Show auto config.` to display the automatically identified network parameters.
- Press ENTER.

15.2 Process interface

The transmitter can be equipped with a process interface (e.g., Modbus). For the connection of the process interface to the transmitter, see supplement to operating instruction.

16 Event trigger

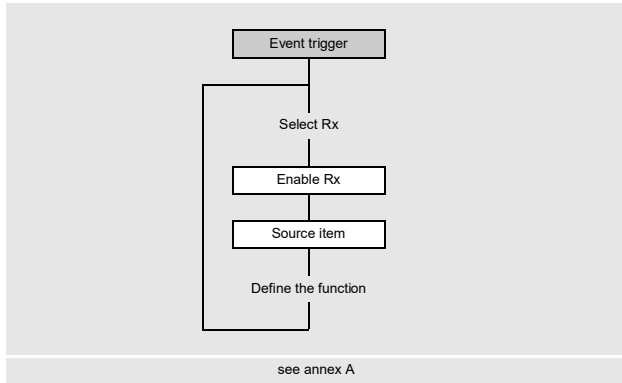

It is possible to activate max. 4 independent event triggers: R1, R2, R3 and R4.

The event triggers can be used, e.g., to output information on the current measurement.

Event trigger

- Select the menu Event trigger.
- Press ENTER.

Event trigger\Rx(-)

- Select an event trigger.
- Press ENTER.

If the event trigger has already been installed, it is displayed as follows: Rx (✓) .

Event trigger\Enable Rx

- Select Yes to change the settings for an already assigned event trigger or to assign a new one.
- Select No to cancel the assignment and to return to the previous menu item.
- Press ENTER.

Event trigger\Enable Rx\Source item

- Select the source item (physical quantity) for which a condition has to be defined.

Tab. 16.1: Source items

| source item | list item | output |
|------------------|-------------------------------|---|
| Refractometer | Symmetry | diagnostic values |
| | Gain | |
| | Amplitude | |
| | Quality | |
| | SNR | |
| Analysis | Volume fraction | physical quantity for analysis selected in the menu <code>Parameters</code> |
| | Brix scale | |
| Fluid properties | Fluid temp. | fluid temperature |
| | Fluid density | fluid density |
| | Norm. density | standardized density |
| Miscellaneous | Custom. Input 1 | If a fieldbus is connected, input quantities (e.g., sound speed, density) which are not used for calculation can be assigned as source item. For the connection of the fieldbuses to the transmitter, see supplement to operating instruction. |
| | Custom. Input 2 | |
| | Custom. Input 3 | |
| | Custom. Input 4 | |
| Refractive index | Refractive index | measured refractive index in the fluid |
| | Refractive index (Δ) | |
| | Norm. refrac. index | |

Afterwards the properties of the event trigger are defined.

Tab. 16.2: Properties of the event trigger

| property | setting | description |
|-----------------------------------|----------------------------|---|
| Function (switching condition) | MAX ($x > \text{limit}$) | The event trigger switches when the measured value exceeds the upper limit. |
| | MIN ($x < \text{limit}$) | The event trigger switches when the measured value falls below the lower limit. |
| | ERR ($x = \text{fail}$) | The event trigger switches when a measurement is not possible. |
| | Within range | The event trigger switches when the measured value is within the defined range. |
| | Out of range | The event trigger switches when the measured value is outside the defined range. |
| Type (holding behavior) | Non-hold | When the switching condition is no longer met, the event trigger returns to the idle state after approx. 1 s. |
| | Hold | The event trigger remains activated even when the switching condition is no longer met. |
| | Hold for a while | The event trigger remains activated during a defined time even when the switching condition is no longer met. |

Definition of the switching condition

```
Event trigger\Enable Rx\Source item\...\Function
```

- Select the switching condition.
- Press ENTER.

Definition of the holding behavior

```
Event trigger\Enable Rx\Source item\...\Type
```

- Select the type of the holding behavior.
- Press ENTER.

Definition of trigger limits

```
Event trigger\Enable Rx\Source item\...\Trigger value
```

The limits are to be entered at which the event trigger has to switch.

- Enter the upper limit MAX ($x > \text{limit}$).
- Press ENTER.
- Enter the lower limit MIN ($x < \text{limit}$).
- Press ENTER.

```
Event trigger\Enable Rx\Source item\...\Hysteresis
```

It is possible to define a hysteresis to avoid constant switching of the event trigger.

The event trigger is activated when the measured values exceed the upper limit. It is deactivated when the measured values fall below the lower limit.

- Enter the value for the hysteresis.
- If zero is entered, no hysteresis is used.
- Press ENTER.

Example

```
MAX (x>limit): 40 wt%
Hysteresis: 1 wt%
```

The event trigger is activated for measured values $> 40.5 \text{ wt\%}$ and deactivated for measured values $< 39.5 \text{ wt\%}$.

```
Event trigger\Enable Rx\Source item\...\Range center
```

- Enter the center of the range in which the event trigger has to be switched.
- Press ENTER.

```
Event trigger\Enable Rx\Source item\...\Range width
```

- Enter the width of the range in which the event trigger has to be switched.
- Press ENTER.

Example

```
Function: Out of range
Range center: 40 wt%
Range width: 10 wt%
```

The event trigger will switch if the measured value is below 35 wt\% or above 45 wt\% .

Definition of the switching delay

```
Event trigger\Enable Rx\Source item\...\Glitch interval
```

- Enter a time interval after which the event trigger has to switch in case the event occurred.
- Press ENTER.

```
Event trigger\Enable Rx\Source item\...\Failure delay
```

- Enter a time interval after which the event trigger has to be deactivated in case of a measurement failure.
- Press ENTER.

16.1 Apparent switching delay

The measured values and totalizer values will be displayed rounded according to the set number of decimal places. The limits, however, will be compared to the non-rounded measured values. This might cause an apparent switching delay when the measured value changes marginally (less than the visualized decimal places). In this case, the switching accuracy of the event trigger is higher than the accuracy of the display.

16.2 Reset and initialization of the event trigger

After an initialization of the transmitter all event triggers are deactivated.

Event triggers whose switching condition is still met will be activated again after 1 s. This function is used to reset event triggers of the type `HOLD` if the switching condition is no longer met.

If a measurement is stopped, all event triggers will be deactivated and the corresponding process outputs will be de-energized, independently of the programmed idle state.

16.3 Event trigger during the measurement

An event trigger with the switching condition `MAX (x>limit)`, `MIN (x<limit)`, `Within range` or `Out of range` is updated max. once per second to avoid a constant switching of the event trigger (in case the measured values fluctuate around the value of the switching condition).

An event trigger with switching condition `ERR (x=fail)` is activated during a measurement failure.

An event trigger of the type `Non-hold` is activated when the switching condition is met. It is deactivated when the switching condition is no longer met. But it remains activated for at least 1 s even when the switching condition is met for a shorter period of time.

An event trigger of the type `Hold` is activated when the switching condition is met. It remains activated even when the switching condition is no longer met.

An event trigger of the type `Hold for a while` is activated when the switching condition is met. The time after which the deactivation takes place is defined in the menu item `Hold interval`.

16.4 Status display of the event trigger





Notice!

There is no visual or acoustic indication of event trigger switching.















The state of the event triggers is displayed during the measurement.

- Press  to scroll through the second line from below until the event trigger status is displayed.



The status display of the event triggers is structured as follows.

Rx =    with x being the number of the event trigger and  a pictogram according to Tab. 16.3.

Tab. 16.3: Pictograms for the status display of the event triggers

| | no. | | Function (switching condition) | Type (holding behavior) | current state |
|---|---|---|---|---|--|
| R |  | = |  |  |  |
| | 1 |  | MAX (x>limit) |  Non-hold |  deactivated (false state) |
| | 2 |  | MIN (x<limit) |  Hold |  activated (true state) |
| | 3 |  | Within range |  Hold for a while | |
| | 4 |  | Out of range | | |
| | |  | ERR (x=fail) | | |

Example

R1 =   

16.5 Event log

If an error occurs, an error message will be displayed in the first line indicating the symbol . The error message can be displayed.

Storage\Event log

- Select the menu item `Event log` in the menu `Storage`.
- Press ENTER.

A list is displayed containing all error messages since the last time the transmitter was switched on.

- Press  to select an error message.
- Press ENTER.

The display indicates the cause of the error.

Notice!

After reading out the event protocol the error message symbol will be deleted on the display, even if the error has not been eliminated yet.

The event protocol will be deleted after a restart of the transmitter.

17 Calibration

Correction values can be entered:

- for the values calculated by the transmitter (e.g., percentage by mass)
- for scale values (z.B. Brix scale).

Correction values for the values calculated by the transmitter

The correction value is added to the value calculated by the transmitter.

```
Calibration\Result offset
```

- Select the menu item `Calibration\Result offset`.
- Press ENTER.
- Select `On` to define an offset for the displayed physical quantity.
- Press ENTER.

Correction values for the scale values

The correction value is added to the scale value.

```
Calibration\Scale offset
```

- Select the menu item `Calibration\Scale offset`.
- Press ENTER.
- Select `On` to define an offset for the scale value.
- Press ENTER.

18 Settings

18.1 Dialogs and menus

Miscellaneous\Dialogs/Menu

- Select the menu item `Dialogs/Menu` in the menu `Miscellaneous`.
- Press ENTER.

Measuring point number

Miscellaneous\Dialogs/Menu\Measuring point no.

- Press ENTER until the menu item `Measuring point no.` is displayed.
- Select `Number` if the measuring point number should only consist of numeric characters. Select `Text` if the measuring point number should only consist of alphabetic characters.
- Press ENTER.

Error delay

The error delay is the time after which an error value will be sent to an output if no valid measured values are available.

Miscellaneous\Dialogs/Menu/Error delay

- Press ENTER until the menu item `Error delay` is displayed.
- Select `Edit` to enter an error delay. Select `Damping` if the damping factor is to be used as the error delay.
- Press ENTER.

Display of the last value

Miscellaneous\Dialogs/Menu\Display last value

- Press ENTER until the menu item `Display last value` is displayed.
- Select `Yes` to display the last valid value.
- Press ENTER.

If `Yes` is selected and no valid measured value can be displayed during the measurement, the last valid value will be displayed. Behind this value an interrogation point will be displayed.

Switching off the display backlight

Miscellaneous\Dialogs/Menu\Light autom. off

- Press ENTER until the menu item `Light autom. off` is displayed.
- Select `Yes` to activate the automatic switch-off.
- Press ENTER.

If the automatic switch-off of the display backlight is activated, the backlight is switched off after about 30 s. When pressing a key or connecting a USB cable, the backlight is switched on again.

18.2 Working with parameter sets

18.2.1 Introduction

Working with parameter sets will make repeated measurement tasks easier and faster. The parameter records contain setup settings of the transmitter. Depending on which measuring task has to be carried out, it is possible to load the corresponding parameter record and use it for the measurement. The transmitter can store up to 20 parameter records.

A parameter record contains among others the following parameters:

- sensor parameters
- fluid parameters
- output quantities
- output parameters

Notice!

No parameter records are stored in the delivery state. Parameter records have to be entered manually.

The parameters have first to be entered in the following menus `Parameters` and `Miscellaneous`. Afterwards, they can be stored as parameter record.

```
Miscellaneous\Param. record memo.
```

- Select the menu item `Param. record memo.` in the menu `Miscellaneous`.
- Press ENTER.
- Select the menu item `Save current record.`
- Press ENTER.

```
Miscellaneous\Param. record name
```

- Enter the name the parameter record has to be stored with.
- Press ENTER.

18.2.2 Load of a parameter record

Stored parameter records can be loaded and used for measurement.

```
Miscellaneous\Param. record memo.\Load param. record
```

- Select the menu item `Load param. record.`
- Press ENTER.
- Select the parameter record to be loaded.
- Press ENTER.

18.2.3 Deletion of parameter records

```
Miscellaneous\Param. record memo.\Delete param. record
```

- Select the menu item `Delete param. record.`
- Press ENTER.
- Select the parameter record to be deleted.
- Press ENTER.

18.3 Contrast settings

The display contrast can be adjusted with the following keys:

-  increase contrast
- CLR reduce contrast

- Press ENTER.

| |
|--|
| Notice! |
| After an initialization of the transmitter, the display is reset to medium contrast. |

18.4 HotCodes

Miscellaneous\System settings\HotCode

- Select the menu item `Miscellaneous` in the menu `System settings`.
- Press ENTER.
- Select the menu item `HotCode`.
- Press ENTER.
- Enter the `HotCode` via the keyboard. For the input of numbers, see section 4.3.
- Press ENTER.

| function | HotCode |
|------------------------------------|---------|
| setting to medium display contrast | 555000 |
| language selection | 9090xx |
| initialization | 909000 |

Language selection

The language selection can either be carried out via the menu `Miscellaneous\System settings\Language` or a `HotCode`:

| language | HotCode |
|----------|---------|
| English | 909044 |
| German | 909049 |
| French | 909033 |
| Spanish | 909034 |
| Dutch | 909031 |
| Russian | 909007 |
| Polish | 909048 |
| Turkish | 909090 |
| Italian | 909039 |
| Chinese | 909086 |

After the last digit has been entered, the main menu is displayed in the selected language. The selected language remains activated when the transmitter is switched off and on again.

18.5 Key lock

An ongoing measurement can be protected from an inadvertent intervention by means of a key lock.

Definition of a key lock code

- Select the menu item `System settings` in the menu `Miscellaneous`.
- Press ENTER.

Miscellaneous\System settings\Key lock

- Select the menu item `Key lock`.
- Press ENTER.
- Enter a 6-digit key lock code. For the input of numbers, see section 4.3.
- Press ENTER.

Notice!

Do not forget the key lock code!

- Enter a 6-digit key lock code. For the input of numbers, see section 4.3.
- Press ENTER.

Intervention in the measurement

If the key lock is activated, the message `Key lock activated` will be displayed for a few seconds when pressing a key. In order to interrupt a measurement, the key lock has to be deactivated.

- Press BRK.
- Select `Show parameters`.
- Press ENTER.
- Deactivate the key lock.

Disabled functions with activated key lock

The following table gives an overview of the transmitter functions that are not available when the key lock is activated.

| measurement not started | measurement started |
|---|--|
| <ul style="list-style-type: none"> • parameter input • modification of settings (e.g., measuring modes) • deletion of the data logger • setting of time/date • start of measurement (start-up) | <ul style="list-style-type: none"> • modification of settings that are available in an ongoing measurement (e.g., language selection) • measurement stop |

Annex

A Menu structure

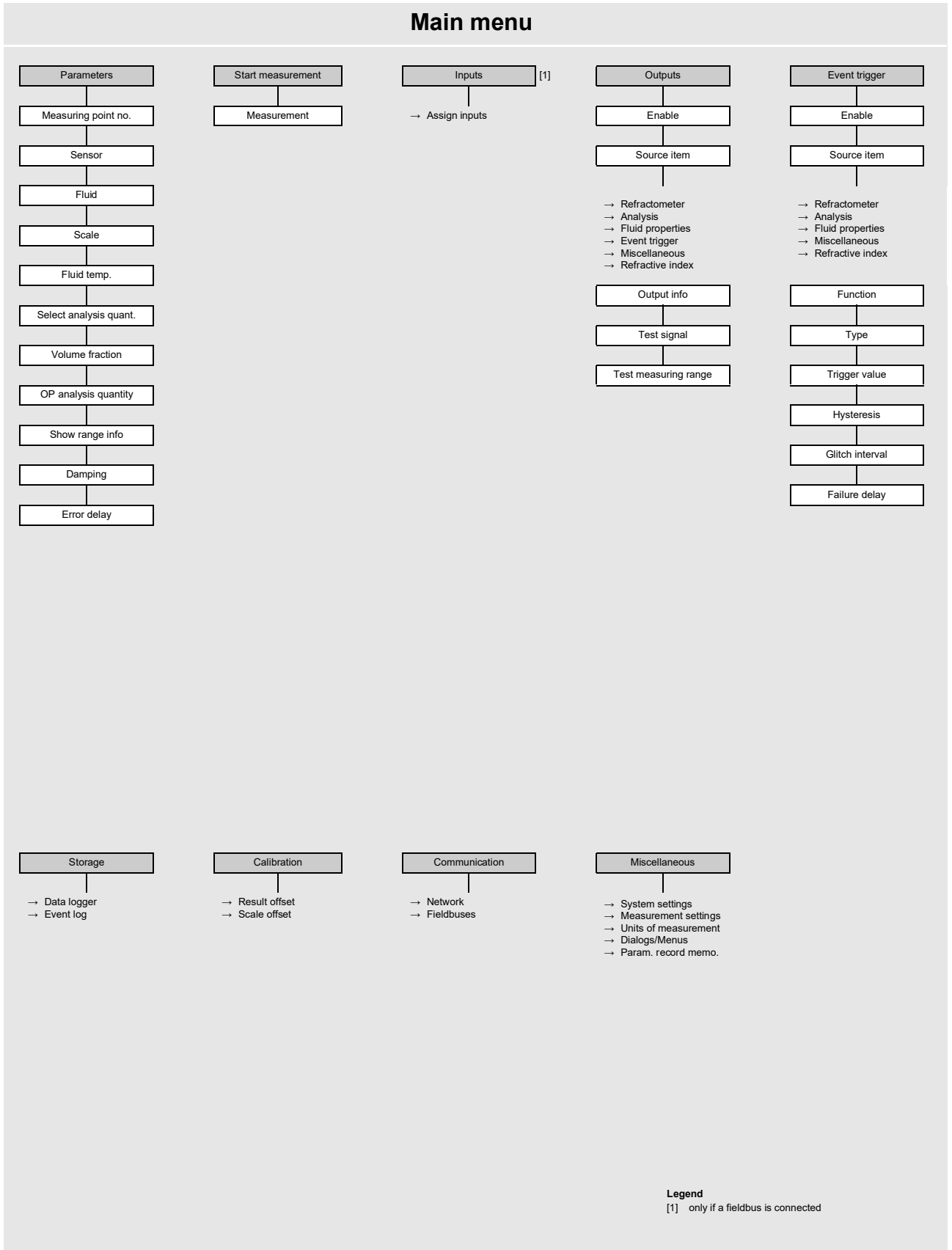

Parameter input

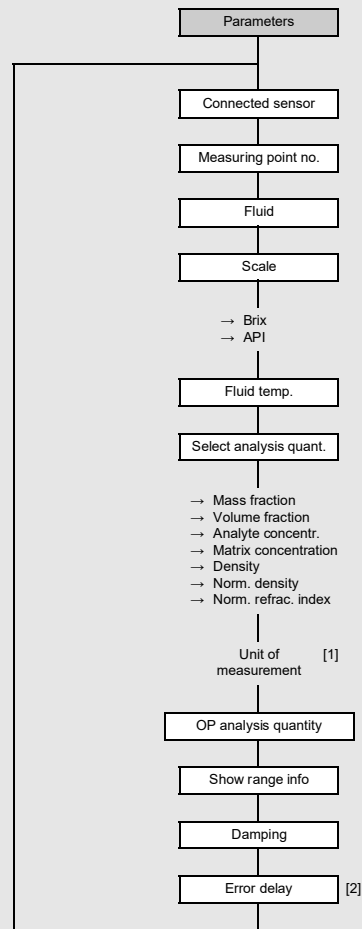

Legend

- [1] only if Mass fraction or Volume fraction has been selected as physical quantity for analysis
- [2] only if Edit is selected in the menu item Miscellaneous\Dialogs\Menus\Error delay

Measurement start

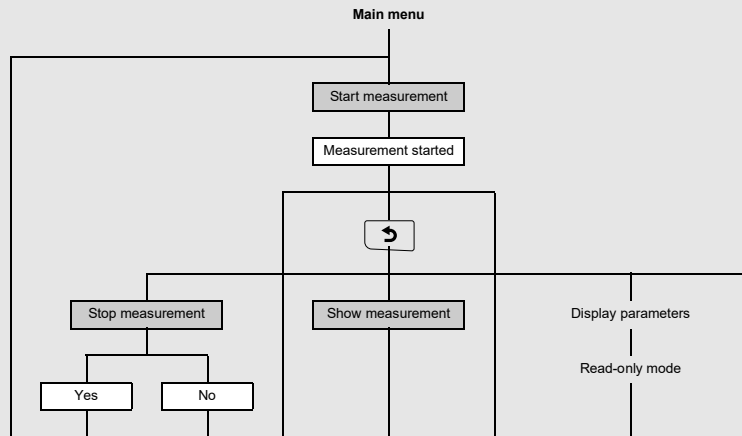

Outputs

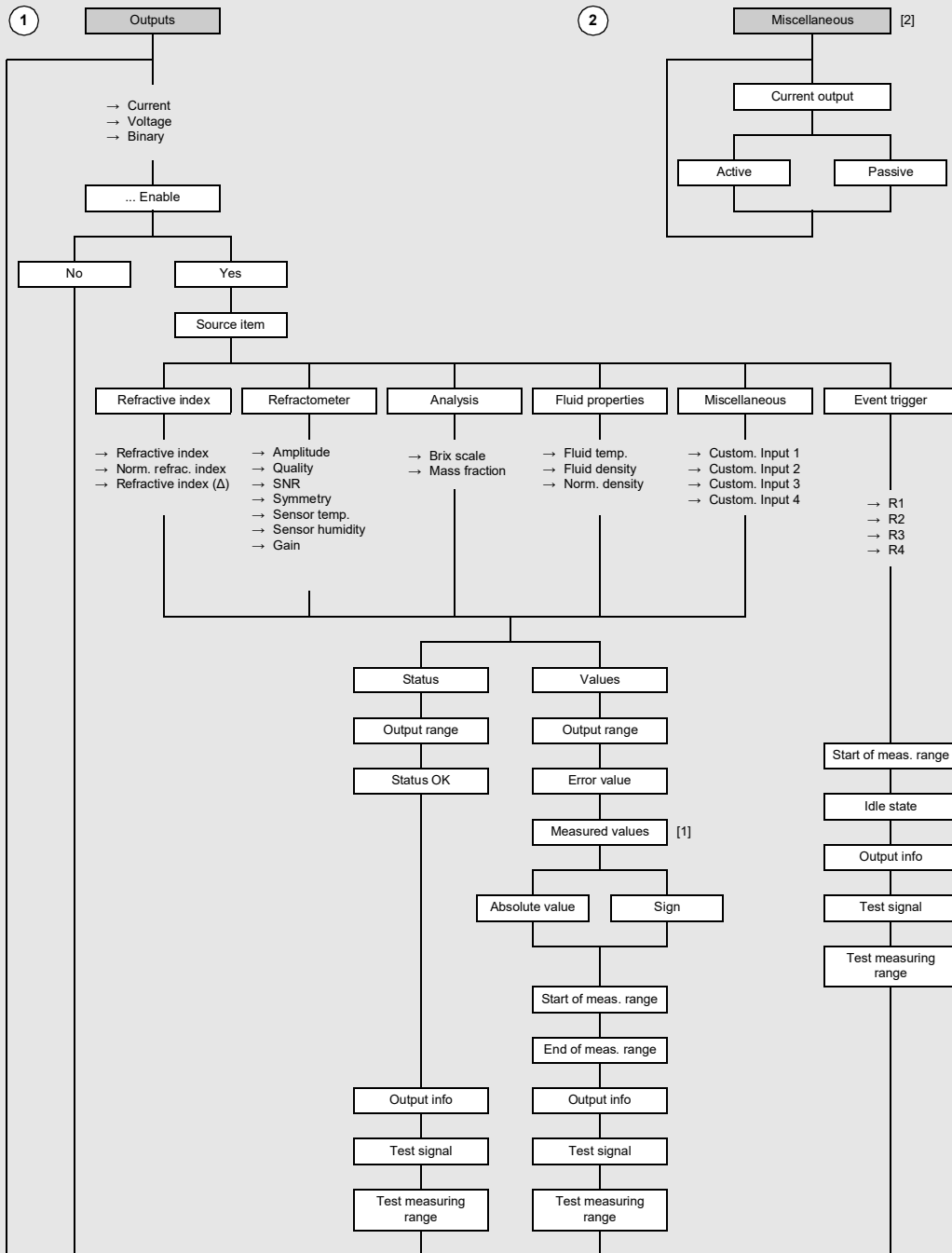

Legend

- [1] requested only if the physical quantity can adopt a negative value
- [2] only if switchable current outputs are available

Event triggers

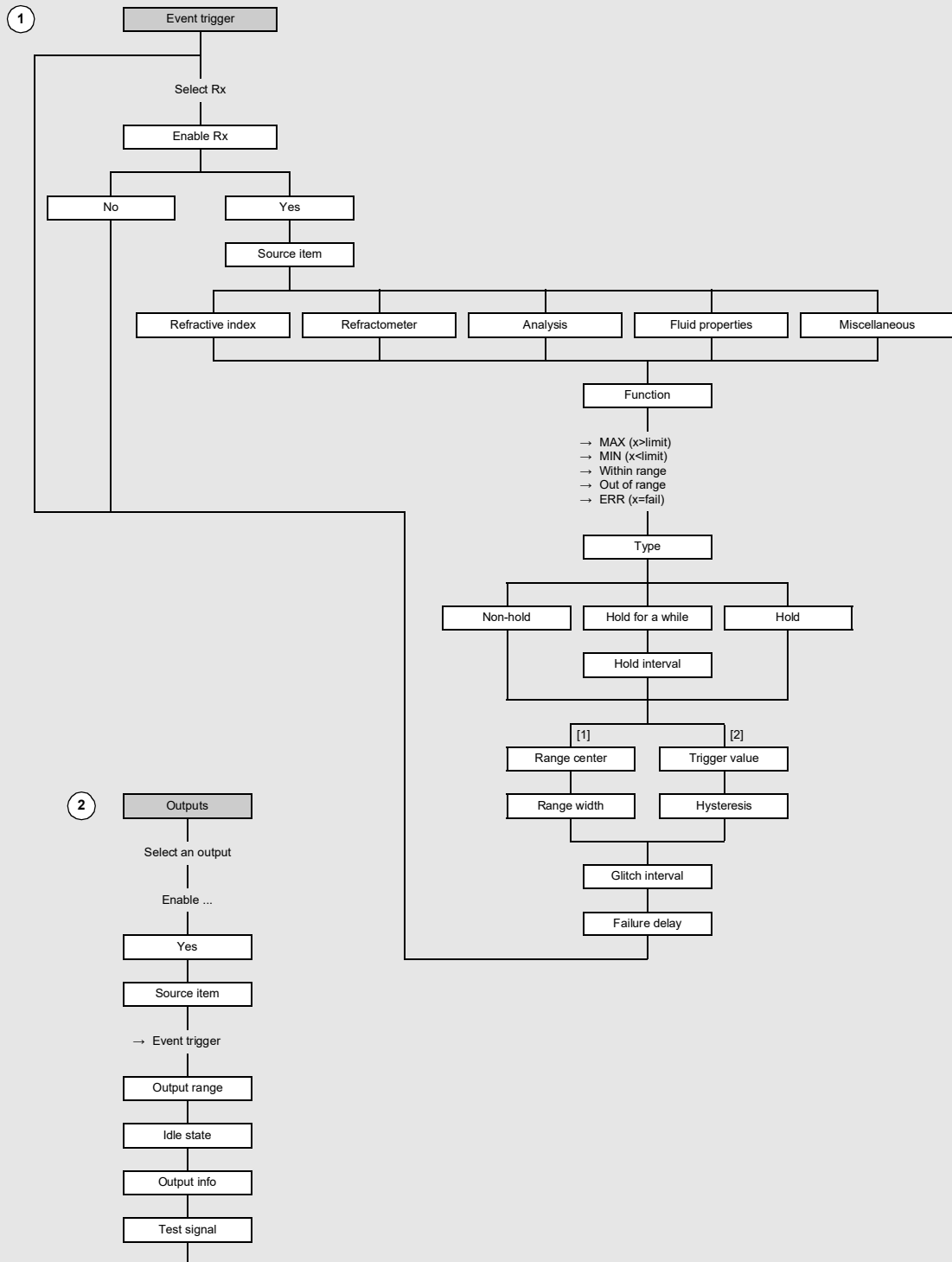

Legend

- [1] if Within range or Out of range has been selected as function
- [2] if MAX (x>limit), MIN (x<limit) or ERR (x=fail) has been selected as function

Data logger

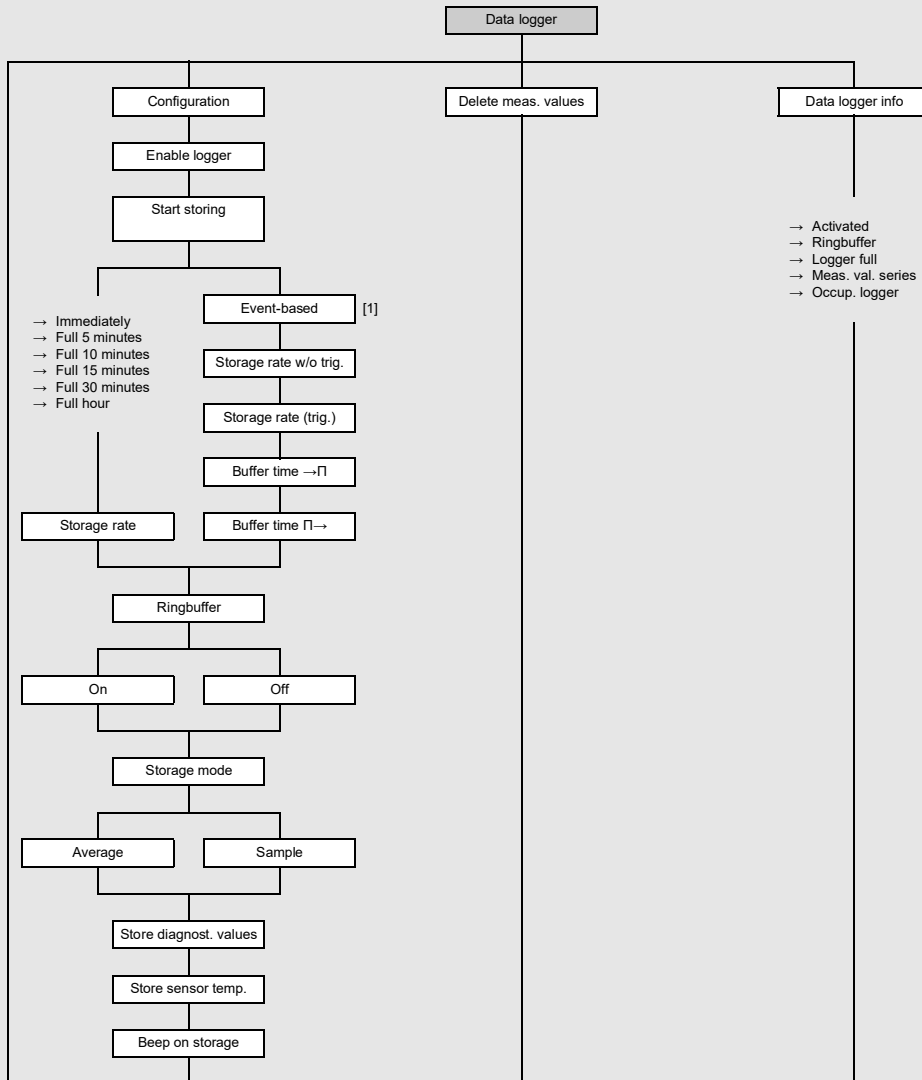

Legend
[1] list of parameterized event triggers

Calibration

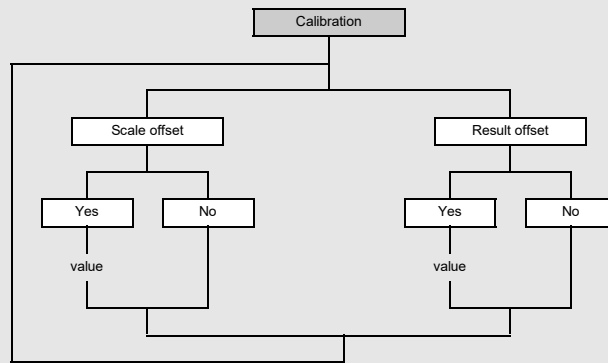

Event-based storing of measured values

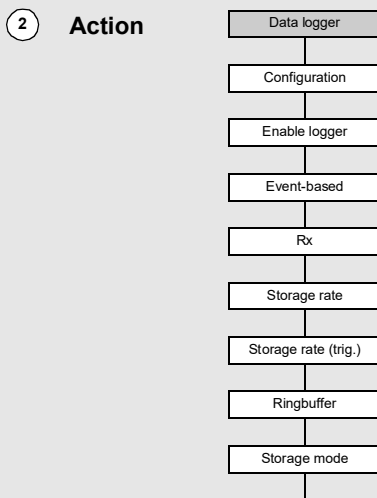
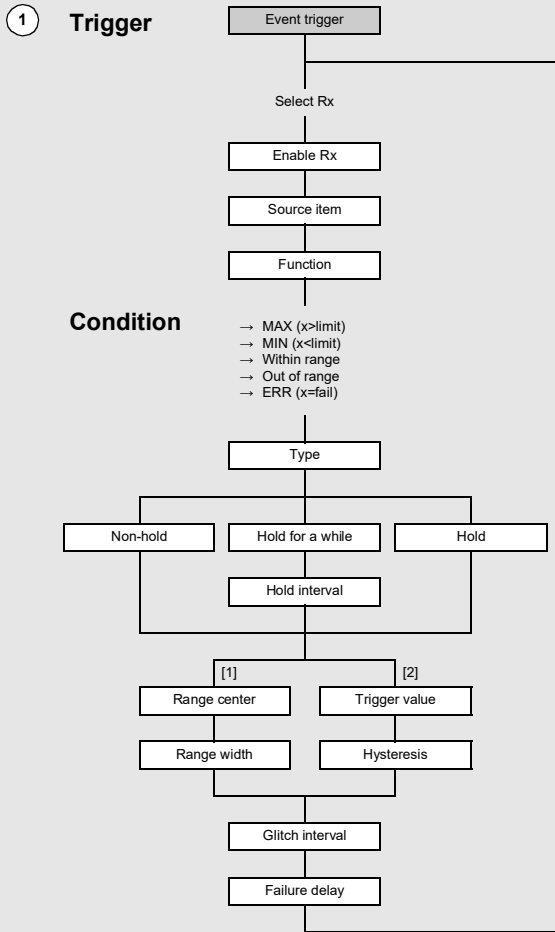

Legend

- [1] if Within range or Out of range has been selected as function
- [2] if MAX (x>limit), MIN (x<limit) or ERR (x=fail) has been selected as function

B Start-up protocol

Start-up

| | | | |
|--------------------|-----------|-----------|--|
| device | | | |
| sensor | PIOX R500 | ser. no.: | |
| transmitter | PIOX R532 | ser. no.: | |

Measuring point (designation):

| | | |
|----------------------------|------------------|--|
| process fluid | | |
| solvent | | |
| physical quantity | | |
| concentration | operating point: | |
| | range: | |
| other components | | |
| fluid temperature | | |
| ambient temperature | | |
| pressure | | |

Settings and measured values in the transmitter:

| | |
|--|--|
| selected fluid in the transmitter | |
|--|--|

Characteristic curve of the fluid created by:

FLEXIM
 customer

Measured values: one representative measured value for each typical process state at the measuring point (e.g., operating point, CIP)

| process state | physical quantity | reference value ⁽¹⁾ | T _{fluid} | n _D | humidity [%] | T _{dev} | amplitude | gain | symmetry |
|---------------|-------------------|--------------------------------|--------------------|----------------|--------------|------------------|-----------|------|----------|
| | | | | | | | | | |
| | | | | | | | | | |
| | | | | | | | | | |
| | | | | | | | | | |
| | | | | | | | | | |

⁽¹⁾ determined with (e.g., lab refractometer, type):

accuracy:

Offset input:

no offset
 result offset _____
 scale offset _____

Outputs

| | type | source item | min. value | max. value | output range [mA] | abs./sign | error [mA] | terminal |
|----|------|-------------|------------|------------|-------------------|-----------|------------|----------|
| I1 | | | | | | | | |
| I2 | | | | | | | | |

| | type | source item | trigger condition | trigger value | trigger hysteresis | switching delay | holding behavior | 0/1 | terminal |
|----|------|-------------|-------------------|---------------|--------------------|-----------------|------------------|-----|----------|
| B1 | | | | | | | | | |
| B2 | | | | | | | | | |

Notes

Start-up completed on:

Signature:

C Maintenance protocol

Maintenance

Date: _____

| | | | |
|--------------------|-----------|-----------|--|
| device | | | |
| sensor | PIOX R500 | ser. no.: | |
| transmitter | PIOX R532 | ser. no.: | |

C.1 Visual inspection

- Clean the sensor. Remove any deposits or dirt on the window and measuring prism.
- Check the sensor head (the part in contact with the fluid). If there are any signs of corrosion, deep scratches or damages, especially on the gaskets, please contact FLEXIM and give a precise description of the problem.

The sensor head is intact: yes no: contact FLEXIM

- Check all gaskets. If the gaskets are swollen or brittle and cracked, send the sensor to FLEXIM to replace the gaskets.

The gaskets are intact: yes no: send the sensor to FLEXIM for repair

C.2 Functional test

Measuring point (designation):

the composition of the fluid has not changed since the last start-up/maintenance date: _____

a changed/new fluid is measured since: _____

Type of change:

| | | |
|----------------------------|------------------|--|
| process fluid | | |
| solvent | | |
| physical quantity | | |
| concentration | operating point: | |
| | range: | |
| other components | | |
| fluid temperature | | |
| ambient temperature | | |
| pressure | | |

Settings and measured values in the transmitter:

| | |
|--|--|
| selected fluid in the transmitter | |
|--|--|

Characteristic curve of the fluid created by:

FLEXIM customer _____

Measured values: one representative measured value for each typical process state at the measuring point (e.g., operating point, CIP)

| process state | physical quantity | reference value ⁽¹⁾ | T _{fluid} | n _D | humidity [%] | T _{dev} | amplitude | gain | symmetry |
|---------------|-------------------|--------------------------------|--------------------|----------------|--------------|------------------|-----------|------|----------|
| | | | | | | | | | |
| | | | | | | | | | |
| | | | | | | | | | |
| | | | | | | | | | |
| | | | | | | | | | |

⁽¹⁾ determined with (e.g., lab refractometer, type):

accuracy:

Comparison of the amplitude values

If the amplitude value measured during maintenance is far below the value measured at the start-up, for example, if the fluid is slightly cloudy, a cleaning of the sapphire optics is recommended.

amplitude value _(maintenance) ≤ 1/20 amplitude value _(start-up)

| |
|---|
| Notice! |
| Make sure that the sensor material (stainless steel 1.4571) and the gaskets (for material, see confirmation of order) are resistant against the cleaning agent. The cleaning agent also has to be suitable for the fluid. |

cleaned with: _____

Check of the zero point (optional)

After the cleaning, we recommend to check the zero point. PIOX R500 is checked using deionized water.

- Select **Brix** in the menu item `Parameters\Fluid\Other fluid\Scale`.

default: Brix value = 0

| operating temperature | Brix value | deviation |
|-----------------------|------------|-----------|
| | | |
| | | |
| | | |
| | | |

Offset input:

no offset

result offset

scale offset

Maintenance completed on:

Signature:

D Legal information – open source licenses

The software of this product contains the following open-source software which is subject to the Apache license version 2.0 dated January 2004:

1. uC-TCP-IP

<https://github.com/weston-embedded/uC-TCP-IP/tree/v3.06.01>

<https://github.com/weston-embedded/uC-TCP-IP/blob/v3.06.01/LICENSE>

<https://github.com/weston-embedded/uC-TCP-IP/blob/v3.06.01/NOTICE>

ATTENTION ALL USERS OF THIS REPOSITORY:

The original work found in this repository is provided by Silicon Labs under the Apache License, Version 2.0.

Any third party may contribute derivative works to the original work in which modifications are clearly identified as being licensed under:

- (1) the Apache License, Version 2.0 or a compatible open source license; or
- (2) under a proprietary license with a copy of such license deposited.

All posted derivative works must clearly identify which license choice has been elected.

No such posted derivative works will be considered to be a "Contribution" under the Apache License, Version 2.0.

SILICON LABS MAKES NO WARRANTY WITH RESPECT TO ALL POSTED THIRD PARTY CONTENT AND DISCLAIMS ALL OTHER WARRANTIES OR LIABILITIES, INCLUDING ALL WARRANTIES OF MERCHANTABILITY, FITNESS FOR A PARTICULAR PURPOSE, TITLE, OWNERSHIP, NON-INFRINGEMENT, AND NON-MISAPPROPRIATION.

In the event a derivative work is desired to be submitted to Silicon Labs as a "Contribution" under the Apache License, Version 2.0, a "Contributor" must give written email notice to micrium@weston-embedded.com. Unless an email response in the affirmative to accept the derivative work as a "Contribution", such email submission should be considered to have not been incorporated into the original work.

2. uC-Common

<https://github.com/weston-embedded/uC-Common/tree/v1.02.01>

<https://github.com/weston-embedded/uC-Common/blob/v1.02.01/LICENSE>

<https://github.com/weston-embedded/uC-Common/blob/v1.02.01/NOTICE>

ATTENTION ALL USERS OF THIS REPOSITORY:

The original work found in this repository is provided by Silicon Labs under the Apache License, Version 2.0.

Any third party may contribute derivative works to the original work in which modifications are clearly identified as being licensed under:

- (1) the Apache License, Version 2.0 or a compatible open source license; or
- (2) under a proprietary license with a copy of such license deposited.

All posted derivative works must clearly identify which license choice has been elected.

No such posted derivative works will be considered to be a "Contribution" under the Apache License, Version 2.0.

SILICON LABS MAKES NO WARRANTY WITH RESPECT TO ALL POSTED THIRD PARTY CONTENT AND DISCLAIMS ALL OTHER WARRANTIES OR LIABILITIES, INCLUDING ALL WARRANTIES OF MERCHANTABILITY, FITNESS FOR A PARTICULAR PURPOSE, TITLE, OWNERSHIP, NON-INFRINGEMENT, AND NON-MISAPPROPRIATION.

In the event a derivative work is desired to be submitted to Silicon Labs as a "Contribution" under the Apache License, Version 2.0, a "Contributor" must give written email notice to micrium@weston-embedded.com. Unless an email response in the affirmative to accept the derivative work as a "Contribution", such email submission should be considered to have not been incorporated into the original work.

3. uC-DHCPc

<https://github.com/weston-embedded/uC-DHCPc/tree/v2.11.01>

<https://github.com/weston-embedded/uC-DHCPc/blob/v2.11.01/LICENSE>

<https://github.com/weston-embedded/uC-DHCPc/blob/v2.11.01/NOTICE>

ATTENTION ALL USERS OF THIS REPOSITORY:

The original work found in this repository is provided by Silicon Labs under the Apache License, Version 2.0.

Any third party may contribute derivative works to the original work in which modifications are clearly identified as being licensed under:

- (1) the Apache License, Version 2.0 or a compatible open source license; or
- (2) under a proprietary license with a copy of such license deposited.

All posted derivative works must clearly identify which license choice has been elected.

No such posted derivative works will be considered to be a "Contribution" under the Apache License, Version 2.0.

SILICON LABS MAKES NO WARRANTY WITH RESPECT TO ALL POSTED THIRD PARTY CONTENT AND DISCLAIMS ALL OTHER WARRANTIES OR LIABILITIES, INCLUDING ALL WARRANTIES OF MERCHANTABILITY, FITNESS FOR A PARTICULAR PURPOSE, TITLE, OWNERSHIP, NON-INFRINGEMENT, AND NON-MISAPPROPRIATION.

In the event a derivative work is desired to be submitted to Silicon Labs as a "Contribution" under the Apache License, Version 2.0, a "Contributor" must give written email notice to micrium@weston-embedded.com. Unless an email response in the affirmative to accept the derivative work as a "Contribution", such email submission should be considered to have not been incorporated into the original work.

4. uC-LIB

<https://github.com/weston-embedded/uC-LIB/tree/v1.39.01>

<https://github.com/weston-embedded/uC-LIB/blob/v1.39.01/LICENSE>

<https://github.com/weston-embedded/uC-LIB/blob/v1.39.01/NOTICE>

ATTENTION ALL USERS OF THIS REPOSITORY:

The original work found in this repository is provided by Silicon Labs under the Apache License, Version 2.0.

Any third party may contribute derivative works to the original work in which modifications are clearly identified as being licensed under:

- (1) the Apache License, Version 2.0 or a compatible open source license; or
- (2) under a proprietary license with a copy of such license deposited.

All posted derivative works must clearly identify which license choice has been elected.

No such posted derivative works will be considered to be a "Contribution" under the Apache License, Version 2.0.

SILICON LABS MAKES NO WARRANTY WITH RESPECT TO ALL POSTED THIRD PARTY CONTENT AND DISCLAIMS ALL OTHER WARRANTIES OR LIABILITIES, INCLUDING ALL WARRANTIES OF MERCHANTABILITY, FITNESS FOR A PARTICULAR PURPOSE, TITLE, OWNERSHIP, NON-INFRINGEMENT, AND NON-MISAPPROPRIATION.

In the event a derivative work is desired to be submitted to Silicon Labs as a "Contribution" under the Apache License, Version 2.0, a "Contributor" must give written email notice to micrium@weston-embedded.com. Unless an email response in the affirmative to accept the derivative work as a "Contribution", such email submission should be considered to have not been incorporated into the original work.

Apache License

Version 2.0, January 2004

<http://www.apache.org/licenses/>

TERMS AND CONDITIONS FOR USE, REPRODUCTION, AND DISTRIBUTION

1. Definitions.

"License" shall mean the terms and conditions for use, reproduction, and distribution as defined by Sections 1 through 9 of this document.

"Licensor" shall mean the copyright owner or entity authorized by the copyright owner that is granting the License.

"Legal Entity" shall mean the union of the acting entity and all other entities that control, are controlled by, or are under common control with that entity. For the purposes of this definition, "control" means (i) the power, direct or indirect, to cause the direction or management of such entity, whether by contract or otherwise, or (ii) ownership of fifty percent (50 %) or more of the outstanding shares, or (iii) beneficial ownership of such entity.

"You" (or "Your") shall mean an individual or Legal Entity exercising permissions granted by this License.

"Source" form shall mean the preferred form for making modifications, including but not limited to software source code, documentation source, and configuration files.

"Object" form shall mean any form resulting from mechanical transformation or translation of a Source form, including but not limited to compiled object code, generated documentation, and conversions to other media types.

"Work" shall mean the work of authorship, whether in Source or Object form, made available under the License, as indicated by a copyright notice that is included in or attached to the work (an example is provided in the Appendix below).

"Derivative Works" shall mean any work, whether in Source or Object form, that is based on (or derived from) the Work and for which the editorial revisions, annotations, elaborations, or other modifications represent, as a whole, an original work of authorship. For the purposes of this License, Derivative Works shall not include works that remain separable from, or merely link (or bind by name) to the interfaces of, the Work and Derivative Works thereof.

"Contribution" shall mean any work of authorship, including the original version of the Work and any modifications or additions to that Work or Derivative Works thereof, that is intentionally submitted to Licensor for inclusion in the Work by the copyright owner or by an individual or Legal Entity authorized to submit on behalf of the copyright owner. For the purposes of this definition, "submitted" means any form of electronic, verbal, or written communication sent to the Licensor or its representatives, including but not limited to communication on electronic mailing lists, source code control systems, and issue tracking systems that are managed by, or on behalf of, the Licensor for the purpose of discussing and improving the Work, but excluding communication that is conspicuously marked or otherwise designated in writing by the copyright owner as "Not a Contribution."

"Contributor" shall mean Licensor and any individual or Legal Entity on behalf of whom a Contribution has been received by Licensor and subsequently incorporated within the Work.

2. Grant of Copyright License. Subject to the terms and conditions of this License, each Contributor hereby grants to You a perpetual, worldwide, non-exclusive, no-charge, royalty-free, irrevocable copyright license to reproduce, prepare Derivative Works of, publicly display, publicly perform, sublicense, and distribute the Work and such Derivative Works in Source or Object form.
3. Grant of Patent License. Subject to the terms and conditions of this License, each Contributor hereby grants to You a perpetual, worldwide, non-exclusive, no-charge, royalty-free, irrevocable (except as stated in this section) patent license to make, have made, use, offer to sell, sell, import, and otherwise transfer the Work, where such license applies only to those patent claims licensable by such Contributor that are necessarily infringed by their Contribution(s) alone or by combination of their Contribution(s) with the Work to which such Contribution(s) was submitted. If You institute patent litigation against any entity (including a cross-claim or counterclaim in a lawsuit) alleging that the Work or a Contribution incorporated within the Work constitutes direct or contributory patent infringement, then any patent licenses granted to You under this License for that Work shall terminate as of the date such litigation is filed.
4. Redistribution. You may reproduce and distribute copies of the Work or Derivative Works thereof in any medium, with or without modifications, and in Source or Object form, provided that You meet the following conditions:
 - (a) You must give any other recipients of the Work or Derivative Works a copy of this License; and
 - (b) You must cause any modified files to carry prominent notices stating that You changed the files; and
 - (c) You must retain, in the Source form of any Derivative Works that You distribute, all copyright, patent, trademark, and attribution notices from the Source form of the Work, excluding those notices that do not pertain to any part of the Derivative Works; and

(d) If the Work includes a "NOTICE" text file as part of its distribution, then any Derivative Works that You distribute must include a readable copy of the attribution notices contained within such NOTICE file, excluding those notices that do not pertain to any part of the Derivative Works, in at least one of the following places: within a NOTICE text file distributed as part of the Derivative Works; within the Source form or documentation, if provided along with the Derivative Works; or, within a display generated by the Derivative Works, if and wherever such third-party notices normally appear. The contents of the NOTICE file are for informational purposes only and do not modify the License. You may add Your own attribution notices within Derivative Works that You distribute, alongside or as an addendum to the NOTICE text from the Work, provided that such additional attribution notices cannot be construed as modifying the License.

You may add Your own copyright statement to Your modifications and may provide additional or different license terms and conditions for use, reproduction, or distribution of Your modifications, or for any such Derivative Works as a whole, provided Your use, reproduction, and distribution of the Work otherwise complies with the conditions stated in this License.

5. **Submission of Contributions.** Unless You explicitly state otherwise, any Contribution intentionally submitted for inclusion in the Work by You to the Licensor shall be under the terms and conditions of this License, without any additional terms or conditions. Notwithstanding the above, nothing herein shall supersede or modify the terms of any separate license agreement you may have executed with Licensor regarding such Contributions.
6. **Trademarks.** This License does not grant permission to use the trade names, trademarks, service marks, or product names of the Licensor, except as required for reasonable and customary use in describing the origin of the Work and reproducing the content of the NOTICE file.
7. **Disclaimer of Warranty.** Unless required by applicable law or agreed to in writing, Licensor provides the Work (and each Contributor provides its Contributions) on an "AS IS" BASIS, WITHOUT WARRANTIES OR CONDITIONS OF ANY KIND, either express or implied, including, without limitation, any warranties or conditions of TITLE, NON-INFRINGEMENT, MERCHANTABILITY, or FITNESS FOR A PARTICULAR PURPOSE. You are solely responsible for determining the appropriateness of using or redistributing the Work and assume any risks associated with Your exercise of permissions under this License.
8. **Limitation of Liability.** In no event and under no legal theory, whether in tort (including negligence), contract, or otherwise, unless required by applicable law (such as deliberate and grossly negligent acts) or agreed to in writing, shall any Contributor be liable to You for damages, including any direct, indirect, special, incidental, or consequential damages of any character arising as a result of this License or out of the use or inability to use the Work (including but not limited to damages for loss of goodwill, work stoppage, computer failure or malfunction, or any and all other commercial damages or losses), even if such Contributor has been advised of the possibility of such damages.
9. **Accepting Warranty or Additional Liability.** While redistributing the Work or Derivative Works thereof, You may choose to offer, and charge a fee for, acceptance of support, warranty, indemnity, or other liability obligations and/or rights consistent with this License. However, in accepting such obligations, You may act only on Your own behalf and on Your sole responsibility, not on behalf of any other Contributor, and only if You agree to indemnify, defend, and hold each Contributor harmless for any liability incurred by, or claims asserted against, such Contributor by reason of your accepting any such warranty or additional liability.

END OF TERMS AND CONDITIONS

APPENDIX: How to apply the Apache License to your work.

To apply the Apache License to your work, attach the following boilerplate notice, with the fields enclosed by brackets "[]" replaced with your own identifying information. (Don't include the brackets!) The text should be enclosed in the appropriate comment syntax for the file format. We also recommend that a file or class name and description of purpose be included on the same "printed page" as the copyright notice for easier identification within third-party archives.

Copyright [yyyy] [name of copyright owner]

Licensed under the Apache License, Version 2.0 (the "License"); you may not use this file except in compliance with the License. You may obtain a copy of the License at

<http://www.apache.org/licenses/LICENSE-2.0>

Unless required by applicable law or agreed to in writing, software distributed under the License is distributed on an "AS IS" BASIS, WITHOUT WARRANTIES OR CONDITIONS OF ANY KIND, either express or implied.

See the License for the specific language governing permissions and limitations under the License.

E Conformity declarations

EU declaration of conformity according to low voltage directive

FLEXIM Flexible Industriemesstechnik GmbH

Boxberger Straße 4
12681 Berlin
Germany

declares as manufacturer under its sole responsibility that the transmitter **PIOX R532aa-NNN** and the sensor **R500**
a = any

comply with the relevant EU regulations and directives, including any amendments valid at the time this declaration was signed.
This declaration of conformity is based on the following harmonized standards:

EU directive 2014/35/EU (low voltage directive) relating to the making available on the market of electrical equipment designed for use within certain voltage limits

EN 61010-1:2010 + A1:2019 Safety requirements for electrical equipment for measurement, control, and laboratory use
+ A1:2019/AC:2019 Part 1: General requirements

EU directive 2014/30/EU (EMC directive) relating to electromagnetic compatibility

EN IEC 61326-1:2021 Electrical equipment for measurement, control, and laboratory use – EMC requirements
Part 1: General requirements

EU directive 2011/65/EU (RoHS directive) on the restriction of the use of certain hazardous substances in electrical and electronic equipment

EN IEC 63000:2018 Technical documentation for the assessment of electrical and electronic products with respect to the restriction of hazardous substances

FLEXIM GmbH

Signed for and on behalf of

Berlin, 2024-02-07

Place and date



Jens Hilpert
Managing Director

UK declaration of conformity according to UK statutory instruments

FLEXIM Flexible Industriemesstechnik GmbH

Boxberger Straße 4
12681 Berlin
Germany

declares as manufacturer under its sole responsibility that the transmitter **PIOX R532aa-NNN** and the sensor **R500 a = any**

comply with the relevant UK regulations and legislations, including any amendments valid at the time this declaration was signed. This declaration of conformity is based on the following designated standards:

UK statutory instruments 2016 No. 1101 (electrical equipment (safety) regulations) relating to the safety of electrical equipment designed for use within certain voltage limits

EN 61010-1:2010 + A1:2019 Safety requirements for electrical equipment for measurement, control, and laboratory use
+ A1:2019/AC:2019 Part 1: General requirements

UK statutory instruments 2016 No. 1091 (EMC regulations) relating to electromagnetic compatibility

EN IEC 61326-1:2021 Electrical equipment for measurement, control, and laboratory use – EMC requirements
Part 1: General requirements

UK statutory instruments 2012 No. 3032 (RoHS regulations) on the restriction of the use of certain hazardous substances in electrical and electronic equipment

EN IEC 63000:2018 Technical documentation for the assessment of electrical and electronic products with respect to the restriction of hazardous substances

FLEXIM GmbH

Signed for and on behalf of

Berlin, 2024-02-07

Place and date



Jens Hilpert
Managing Director

Operating Instruction

UMPIOX_R532V1-0-0-0EN

AN 26842

For more information: **Emerson.com**

© 2024 Emerson. All rights reserved.

Emerson Terms and Conditions of Sale are available upon request.

The Emerson logo is a trademark and service mark of Emerson Electric Co. Flexim is a mark of one of the Emerson family of companies. All other marks are the property of their respective owners.

FLEXIM

