

Assembly and operating instructions

Compact Slide CS 8 | CS 12

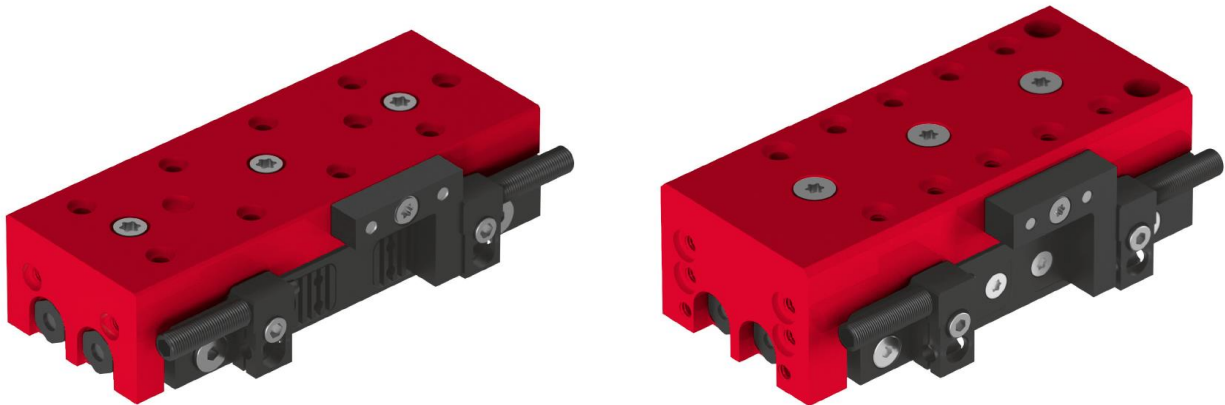

Translation of the Original Assembly Instructions EN

- | | |
|-------------------------------------|--------------------------------------|
| ■ CS 8/10-SD ⇒ Order no.: 50036720 | ■ CS 12/30-SD ⇒ Order no.: 50048476 |
| ■ CS 8/30-SD ⇒ Order no.: 50035820 | ■ CS 12/60-SD ⇒ Order no.: 50050602 |
| ■ CS 8/60-SD ⇒ Order no.: 50035829 | ■ CS 12/90-SD ⇒ Order no.: 50050825 |
| ■ CS 8/10-ED ⇒ Order no.: 50300525 | ■ CS 12/30-ED ⇒ Order no.: 50300528 |
| ■ CS 8/30-ED ⇒ Order no.: 50300526 | ■ CS 12/60-ED ⇒ Order no.: 50300529 |
| ■ CS 8/60-ED ⇒ Order no.: 50300527 | ■ CS 12/90-ED ⇒ Order no.: 50300530 |
| ■ CS 8/10-SDH ⇒ Order no.: 50509361 | ■ CS 12/30-SDH ⇒ Order no.: 50509653 |
| ■ CS 8/30-SDH ⇒ Order no.: 50509609 | ■ CS 12/60-SDH ⇒ Order no.: 50509713 |
| ■ CS 8/60-SDH ⇒ Order no.: 50509576 | ■ CS 12/90-SDH ⇒ Order no.: 50509725 |

Dear Customer,

Thank you for choosing our products and placing your trust and confidence in our company!

These assembly and operating instructions contain all essential information you need about your product. Our aim is to provide the required information as concisely and clearly as possible. If, however, you still have any questions on the contents or suggestions, please do not hesitate to contact us. We are always grateful for any feedback.

Our team will also be glad to answer any further question you may have regarding the compact slide or other options.

We wish you every success with our products!

With kind regards

Your Afag team

© Subject to modifications

The compact slides CS 8 - CS 12 have been designed by Afag Automation AG according to the state of the art. Due to the constant technical development and improvement of our products, we reserve the right to make technical changes at any time.

Updates of our documentations



Unlike the printed documents, our digital instructions manuals, product data sheets and catalogues are being continuously updated on our website.

Please keep in mind that the digital documents on our website are always the latest versions.

© Copyright 2022 Afag Automation AG

All contents of the present assembly and operating instructions, in particular the texts, photographs and graphics, are protected by copyright. All rights reserved. No part of these assembly and operating instructions may be reproduced, distributed (made available to third parties), or transmitted in any form or by any means, including photocopying, recording, or other electronic or mechanical methods, without the prior written permission of Afag Automation AG.

Afag Automation AG
Luzernstrasse 32
CH-6144 Zell (Switzerland)
Tel.: +41 62 959 86 86
e-mail: sales@afag.com
Internet: www.afag.com

Table of contents

1	General	6
1.1	Contents and purpose of these assembly instructions.....	6
1.2	Explanation of symbols.....	6
1.3	Additional symbols.....	7
1.4	Applicable documents	8
1.5	Warranty	8
1.6	Liability.....	8
2	Safety instructions	9
2.1	General	9
2.2	Intended use.....	9
2.3	Foreseeable misuse	9
2.4	Obligations of the operator and the personnel	10
2.4.1	Observe the assembly instructions	10
2.4.2	Obligations of the operating company.....	10
2.4.3	Obligations of the personnel	11
2.5	Personnel requirements	11
2.5.1	Personnel qualification	11
2.6	Personal protective equipment (PPE)	12
2.7	Changes and modifications	12
2.8	General hazards / residual risks	13
2.8.1	General hazards at the workplace	13
2.8.2	Danger due to electricity	14
2.8.3	Mechanical hazards	14
2.8.4	Danger due to pneumatics	15
2.8.5	Danger caused by omitting maintenance work	15
3	Technical data	16
3.1	Compact slide CS 8.....	16
3.1.1	Masszeichnung CS 8	16
3.1.2	Dimensional drawing CS 8 SDH	17
3.1.3	Technical data CS 8	18
3.1.4	Technical data CS 8 SDH	19
3.1.5	Preferred combinations CS 8	20
3.1.6	Slide loads CS 8.....	21
3.1.7	Operation time diagram CS 8.....	22
3.2	Compact slide CS 12.....	23
3.2.1	Dimensional drawing CS 12.....	23
3.2.2	Dimensional drawing CS 12 SDH	24
3.2.3	Technical data CS 12	25
3.2.4	Technical data CS 12 SDH	26
3.2.5	Preferred combinations CS 12	27

3.2.6	Slide loads CS 12.....	28
3.2.7	Operation time diagram CS 12.....	29
4	Transport, packaging and storage	30
4.1	Safety instructions for transport.....	30
4.2	Scope of supply	31
4.3	Transport	31
4.4	Packaging.....	32
4.5	Storage	32
5	Design and description	33
5.1	Design compact slide - CS8 and CS12 with SDH.....	33
5.2	Product description.....	33
5.3	Accessories CS 8 and CS 12.....	34
6	Installation, assembly & setting	35
6.1	Safety Instructions for Installation & assembly.....	35
6.2	Installation and assembly	36
6.2.1	Assembly and attachment.....	36
6.2.2	Tightening torques for screws	37
6.2.3	Connection to the pneumatic system.....	38
6.3	Installation and adjustment of the proximity switch	40
6.4	Query sensors	41
6.5	Adjustment of the shock absorber.....	42
6.5.1	Safety notes for settings.....	42
6.5.2	Adjustment of the elastomer shock absorber.....	43
6.5.3	Adjustment of the hydraulic shock absorber	44
6.5.4	Adjusting the shock absorbers and stop screws.....	45
6.6	End position control for entire stroke range	46
7	Commissioning	47
7.1	Safety instructions for commissioning.....	47
7.2	Vorbereitungen zur Inbetriebnahme.....	48
7.3	Commissioning of the modules	49
8	Fault elimination.....	50
8.1	General Notes	50
8.2	Safety instructions for troubleshooting	50
8.3	Table Fault causes and remedy	50
9	Maintenance and repair	51
9.1	General notes	51
9.2	Safety instructions for maintenance and repair.....	51
9.3	Maintenance activities and maintenance intervals.....	52
9.3.1	Overview of the maintenance points.....	52
9.3.2	Compressed air specifications	53

9.3.3	Further maintenance	54
9.4	Spare and wear parts lists, repairs	54
9.4.1	General notes.....	54
9.4.2	Safety instructions	54
9.4.3	Wear parts for elastomer shock absorbers	55
10	Decommissioning, disassembly, disposal.....	56
10.1	Safety instructions for decommissioning, disassembling and disposal.....	56
10.2	Decommissioning	56
10.3	Disassembly	56
10.4	Disposal	57
11	Declaration of incorporation.....	58

1 General

1.1 Contents and purpose of these assembly instructions

These assembly instructions contain important information on assembly, commissioning, functioning and maintenance of the compact slides CS 8 and/or CS 12 to ensure safe and efficient handling and operation.

Consistent compliance with these assembly instructions will ensure:

- permanent operational reliability of the compact slide,
- optimal functioning of the compact slide,
- timely detection and elimination of defects (thereby reducing maintenance and repair costs),
- extension of the service life of the compact slide.

The illustrations in this manual shall provide you with a basic understanding of the module and may vary from the actual design of your module.

1.2 Explanation of symbols

The safety notes are marked by a pictogram and a signal word. The safety notes describe the extent of the hazard.

DANGER



Danger!

This safety note indicates an imminently hazardous situation which, if not avoided, will result in death or serious injury.

WARNING



Warning!

This safety note points out a potentially hazardous situation which, if not avoided, could result in death or serious injury.

CAUTION



Caution!

This safety note points out a potentially dangerous situation which, if not avoided, can result in minor or slight injuries.

NOTICE

This safety note points out a potentially dangerous situation which, if not avoided, can cause substantial damage to property and the environment.



This note contains important additional information as well as useful tips for safe, efficient and trouble-free operation of the compact slide.

Further warning signs:

Where applicable, the following standardised symbols are used in this manual to point out the various potential health risks.

	Warning - Dangerous electrical voltage.
	Warning - Risk of injury from contact with hot surfaces.
	Warning - Risk of hand and finger injury due to uncontrolled movements of components.
	Warning - Risk of injury as a result of parts being flung out!
	Warning - high noise levels.

1.3 Additional symbols

In these assembly instructions the following symbols are used to highlight instructions, results, references, etc..

Symbol	Description
1.	Instructions (steps ...)
⇒	Results of actions
↻	References to sections
■	Enumerations not ordered

1.4 Applicable documents

In addition to the assembly instructions, the following documents must be observed:

- Safety data sheets etc.
- Instructions for integrated components (→supplier documentation)



Each compact slide is accompanied by a safety information sheet. This information sheet must be read carefully by every person who carries out work on and with the compact slide.

1.5 Warranty

The warranty terms for Afag handling components and handling systems are the following:

- 24 months from initial operation and up to a maximum of 27 months from delivery.
- Wear parts (e.g. shock absorbers) are excluded from the warranty.*

The warranty covers the replacement or repair of defective Afag parts. Further claims are excluded.

* *However, a customer has a right to a defect-free product. This does also apply to defective accessories and wear parts. Normal wear and tear are excluded from the warranty.*

The warranty shall expire in the following cases:

- Improper use of the module.
- Non-observance of the instructions regarding assembly, commissioning, operation and maintenance of the module.
- Improper assembly, commissioning, operation and maintenance.
- Repairs and design changes carried out without prior technical instructions of Afag Automation AG.
- Removing the serial number from the product.
- Using the compact slide without shock absorbers or with defective shock absorbers.
- Inadequate checking of wear parts.
- Non-observance of the EC Machinery Directive, the Accident Prevention Regulations, the Standards of the German Electrotechnology Association (VDE) and these safety and assembly instructions.

1.6 Liability

No changes shall be made to the compact slide unless described in these instructions manual or approved in writing by Afag Automation AG.

Afag Automation AG accepts no liability for unauthorized changes or improper assembly, installation, commissioning, operation, maintenance or repair work.

2 Safety instructions

2.1 General

This chapter provides an overview of all important safety aspects to ensure safe and proper use of the compact slide and optimal protection of personnel.



Failure to follow the directions and safety instructions given in this instructions manual may result in serious hazards.

2.2 Intended use

The compact slide CS is used for shock-free linear movement of fixed loads in the ambient and operating conditions defined for this module.

The CS compact slides are designed exclusively for linear movement in any position on the slide for load capacities up to a maximum of (CS 8/10 = 0.3 kg), (CS 8/30/60 = 0.7 kg), (CS 12 = 1.2 kg). Load capacities at the front of the modules (CS 8/10 = 0.3 kg), (CS 8/30/60 = 0.4 kg), (CS 12 = 0.7 kg).

The CS compact slides can be used in combination with other modules as a pick-and-place station, whereby the permissible load capacity must not be exceeded.

Any use of the compact slide beyond the described purpose is considered to be not in accordance with the intended use.



The intended use of the module also includes:

- observance of all instructions given in this instructions manual.
 - compliance with the inspection and maintenance work and the specifications in the data sheets,
 - using only original spare parts.
-

2.3 Foreseeable misuse

Any use other than or beyond the intended use described above is considered a misuse of the compact slide.

Especially the following use is considered a misuse:

- Use in potentially explosive atmospheres.

WARNING

Risk of injury if the module is not used as intended!

The improper use of the compact slide poses a potential hazard to the personnel.

- The compact slide may only be used in a technically perfect condition in accordance with its intended use and the instructions in this manual as well as in compliance with the safety requirements!
- Any malfunctions, particularly those that could impair safety, must be eliminated immediately!



Risks can occur if the module is not used as intended. In the event of damages caused by improper use the following shall apply:

- the operating company shall be solely responsible for such damage, and
- AFAG does not accept any liability for damage caused by improper use.

2.4 Obligations of the operator and the personnel

2.4.1 Observe the assembly instructions

A basic prerequisite for safe and proper handling of the compact slide is a good knowledge of the basic safety instructions.



These assembly instructions, in particular the safety instructions contained therein, must be observed by all persons working with the compact slide.

2.4.2 Obligations of the operating company

In addition to the safety instructions given in this manual, the operating company must comply with the safety, accident prevention and environmental protection regulations valid for the field of application of the compact slide.

The operating company is required to use only personnel who :

- have the necessary professional qualifications and experience,
- are familiar with the basic rules regarding occupational safety and accident prevention,
- have been instructed in the correct handling of the compact slide,
- have read and understood these assembly instructions.

The operating company is also required to:

- monitor on an ongoing basis that the personnel work safely considering any potential hazard involved and the assembly instructions are observed,
- ensure that the assembly instructions are always kept at hand at the installation in which the modules are mounted,
- observe and communicate universally applicable laws and regulations regarding accident prevention and environmental protection,
- provide the necessary personal protective equipment (e.g. protective gloves) and instruct the personnel to wear it,

- update the related safety data sheets.

2.4.3 Obligations of the personnel

All personnel working with the CS modules are required to:

- read and observe these assembly instructions, especially the chapter on safety,
 - observe the occupational safety and accident prevention regulations,
 - observe all safety and warning signs on the compact slide,
 - refrain from any activity that might compromise safety and health.
-



In addition, the personnel must wear the personal protective equipment required for carrying out their work. (➔Chapter 2.6).

2.5 Personnel requirements

2.5.1 Personnel qualification

The activities described in the assembly instructions require specific requisites at the level of professional qualifications of the personnel.

Personnel not having the required qualification will not be able to assess the risks that may arise from the use of the compact slide thus exposing himself and others to the risk of serious injury. Therefore, only qualified personnel may be permitted to carry out the described activities on the compact slide.

Persons whose ability to react is restricted due to the intake of medication or the like must not interact with the compact slide.

These installation instructions are intended for skilled personnel (installers, system integrators, maintenance personnel, technicians), electricians and operating personnel.

The following is a description of the professional skills (qualifications) required for carrying out the different activities:

Qualified personnel:

Qualified personnel with appropriate training who are qualified due to their special know-how and fully familiar with the machine and who have been given instructions on how to carry out the task entrusted to them safely.

Operator (trained personnel):

Authorized persons who due to their specialized professional training, expertise and experience are capable of identifying risks and preventing possible hazards arising from the use of the machine.





2.6 Personal protective equipment (PPE)

The personal protective equipment serves to protect the personnel from hazards affecting their safety and health at work.

When working on/with the CS module, the personnel must wear the personal protective equipment assigned by the safety officer of the operating company or as required by safety regulations. In addition, the personnel are required to:

- wear the personal protective equipment provided by the operating company (employer),
- check the personal protective equipment for proper condition, and
- immediately notify the person responsible on site of any defects found on the personal protective equipment.

Personal protective equipment and the respective mandatory signs:

	<p><i>Protective clothing</i> is a close-fitting clothing specifically designed to protect personnel from hazards during work.</p>
	<p><i>Protective gloves</i> are specifically designed to protect the personnel against hand injuries (such as cuts, abrasion, burns).</p>
	<p><i>Safety shoes</i> are specifically designed to protect the personnel against foot injuries from crushing, falling objects or slipping on slippery surfaces.</p>
	<p>Hearing <i>protectors</i> are required to protect the personnel against excessive noise levels to prevent noise-induced hearing loss.</p>

2.7 Changes and modifications

No changes may be made to the compact slide which have not been described in these assembly instructions or approved in writing by Afag Automation AG.

Afag Automation AG accepts no liability for unauthorised changes or improper assembly, installation, commissioning, maintenance or repair work.



The compact slide may not be changed or modified in any way, except with the prior written consent of Afag Automation AG.

2.8 General hazards / residual risks

Despite the safe design of the machine and the technical protective measures taken, there still remain residual risks that cannot be avoided and which present a non-obvious residual risk when operating the compact slides.

Observe the safety instructions in this chapter and in the other sections of this manual to avoid damage to property and dangerous situations for the personnel.

2.8.1 General hazards at the workplace

The compact slide has been built according to the state-of-the-art and the applicable health and safety requirements. However, improper use of the compact slide may cause the following hazards to the personnel:

- danger to life and limb of the operator or third parties,
- to the compact slide itself,
- property damage.



Always keep the assembly instructions ready at hand at the workplace! Please, also observe:

- the general and local regulations on accident prevention and environmental protection,
 - the safety information sheet for the CS module.
-

WARNING



Danger - Do not use in unsuitable environment!

The compact slides are designed for use in **non-**explosive atmospheres.

- Do **not** use the compact slide in potentially explosive atmospheres!
-

CAUTION



Risk of injuries due to uncontrolled parts movements!

When operating the compact slide uncontrolled movements may occur which can cause personal injury or property damage.

- Only qualified personnel may work with or on the compact slide.
 - Read the assembly instructions carefully before carrying out any work on or with the compact slide.
-

CAUTION



Risk of noise-induced hearing loss!

When the compact slides are installed in a machine or plant, the permissible noise level may be exceeded depending on the various components, the environment and the resonance.

- The operating company is responsible for ensuring that the permissible noise levels are observed.
- If the noise level exceeds 85 dB(A) in normal operation, the operator must wear hearing protectors at the workplace.

2.8.2 Danger due to electricity

WARNING



Danger! Risk of electric shock!

If work on electrical components is required, ensure that the work is carried out properly, failure to do so will cause serious or fatal injuries.

- Work on the machine's electrical equipment may only be performed by skilled electrician or trained personnel under the supervision of a skilled electrician in accordance with all relevant electrical regulations.

2.8.3 Mechanical hazards

WARNING



Risk of injury - Do not reach into the system during operation!

There is a risk of injury if the personnel reach into the system during normal operation.

- Never reach into the system during normal operation!

CAUTION



Danger of injury by moving components!

Limbs can be crushed by moving components!

- Work on and with the compact slide may only be carried out by qualified personnel.

2.8.4 Danger due to pneumatics

WARNING



Risks by the pneumatic system!

The pneumatic system can pose various hazards that can cause serious or fatal injuries if the work is carried out improperly.

- Only qualified personnel may work with or on the pneumatic system!
 - The necessary personal protective equipment must be provided and used.
-

2.8.5 Danger caused by omitting maintenance work

CAUTION



Danger of injury!

Poor or not regularly performed maintenance work may cause malfunction of the components which may result in injuries.

- The due diligence obligations of the operating company include ensuring that the personnel carrying out maintenance work is appropriately trained and qualified.
-

3 Technical data

3.1 Compact slide CS 8

3.1.1 Dimensional drawing CS 8

Type	CS 8/10	CS 8/30	CS 8/60
A	54 mm	90 mm	120 mm
B		66 mm	96 mm
C	7.5 mm	11 mm	8 mm
D	2 x 20 mm	3 x 20 mm	5 x 20 mm
E	20 mm	3 x 20 mm	4 x 20 mm
F		23.5 mm	23.5 mm
G	Screw-through (CS 8/30 and CS 8/60)		
P	M5	M5	M5



Abb. 1 Dimensional drawing Compact Slide CS 8

Technical data

3.1.2 Dimensional drawing CS 8 SDH

Type	CS 8/10-SDH	CS 8/30-SDH	CS 8/60-SDH
A	54 mm	90 mm	120 mm
B		66 mm	96 mm
C	7.5 mm	11 mm	8 mm
D	2 x 20 mm	3 x 20 mm	5 x 20 mm
E	20 mm	3 x 20 mm	4 x 20 mm
F		23.5 mm	23.5 mm
G	Screw-through (CS 8/30 and CS 8/60)		
P	M5	M5	M5

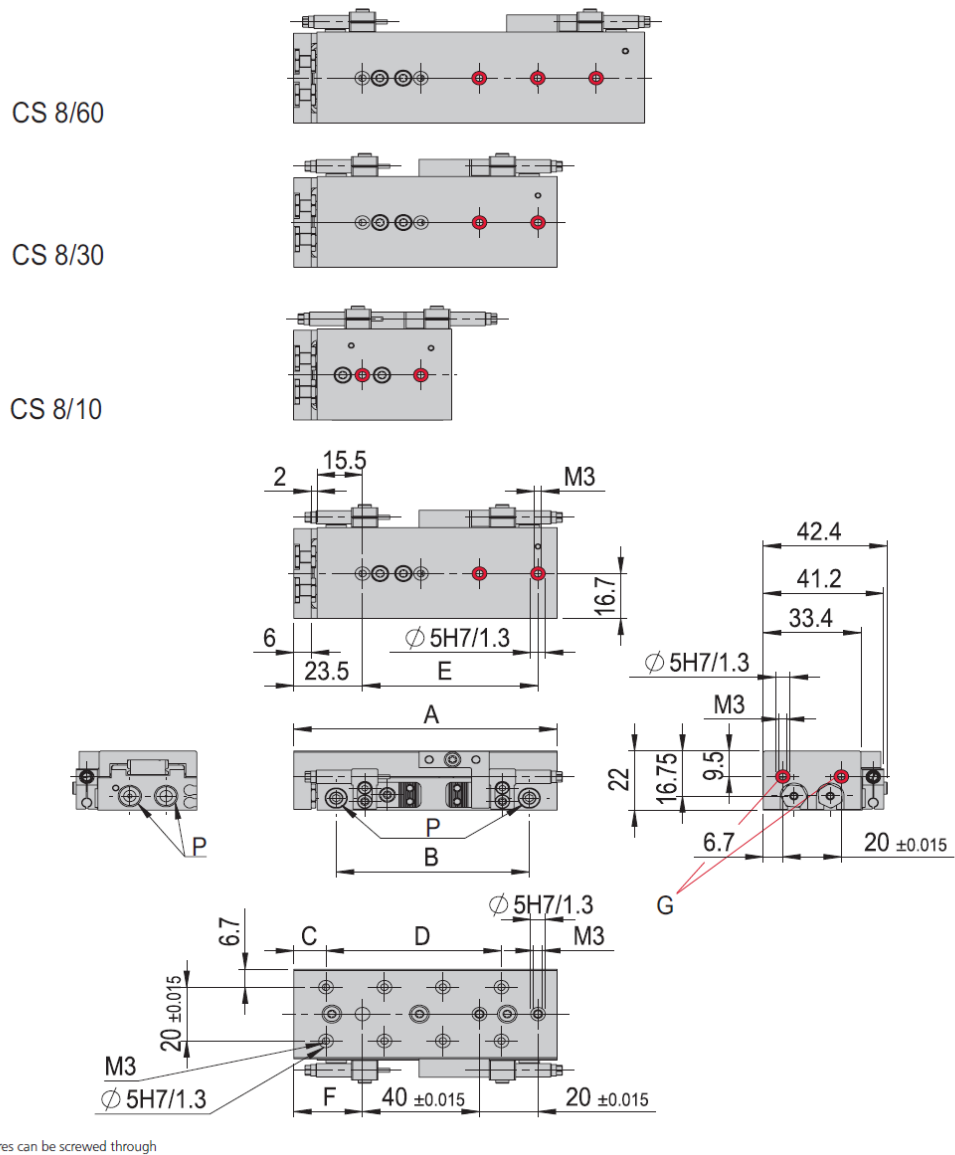
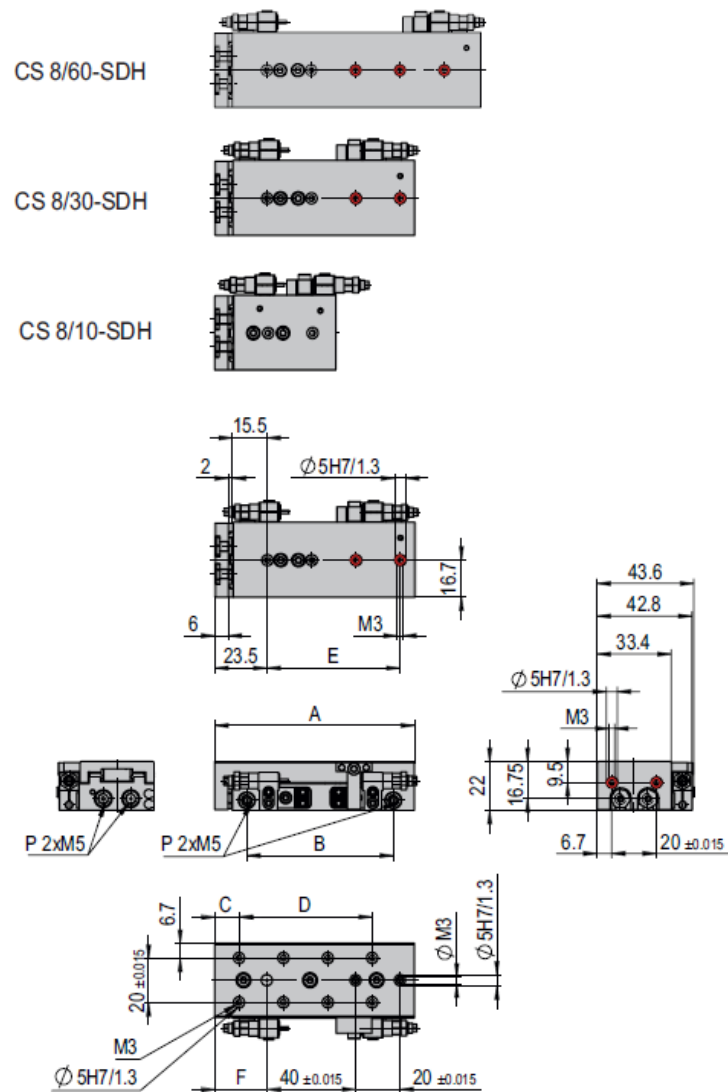

Bores can be screwed through

Fig. 2 Dimensional drawing Compact Slide CS 8 SDH

3.1.3 Technical data CS 8

CS 8	
Attachment grid	20 x 20 mm
Attachment thread	M3
Operating pressure	6 +/- 2 bar
Air connection P	M5
Cylinder Ø	2 x 6 mm
Retract piston force	25 N
Extend piston force	34 N
Operating temperature	0 - 50 °C
Storage temperature	0 - 50 °C
Humidity	< 90 %
Medium filtered compressed air	10 - 40 µm

Type	CS 8/10-ED	CS 8/10-SD	CS 8/30-ED	CS 8/30-SD	CS 8/60-ED	CS 8/60-SD
Order number	50300525	50036720	50300526	50035820	50300527	50035829
Stroke H	10 mm	10 mm	30 mm	30 mm	60 mm	60 mm
Stroke limitation	2 x 10 mm	2 x 10 mm	2 x 25 mm	2 x 25 mm	2 x 25 mm	2 x 25 mm
Net weight	0.176 kg	0.175 kg	0.241 kg	0.24 kg	0.288 kg	0.287 kg
Moving weight	0.07 kg	0.07 kg	0.11 kg	0.11 kg	0.14 kg	0.14 kg
Air consumption/cycle	0.005 NL	0.005 NL	0.014 NL	0.014 NL	0.027 NL	0.027 NL
Noise level	60 dB (A)	60 dB (A)	60 dB (A)	60 dB (A)	60 dB (A)	60 dB (A)
Repeat accuracy	+/- 0.01 mm	+/- 0.01 mm	+/- 0.01 mm	+/- 0.01 mm	+/- 0.01 mm	+/- 0.01 mm
Maximum speed	1 m/s	1 m/s	1 m/s	1 m/s	1 m/s	1 m/s
Minimum speed	0.05 m/s	0.05 m/s	0.05 m/s	0.05 m/s	0.05 m/s	0.05 m/s
Mounting position	✚	✚	✚	✚	✚	✚

The technical data refers to a nominal pressure of 6 bar under Afag standard test conditions. The maximum payloads are listed in the payloads table in the slide loads section.
 Note: the CS 8/...-ED are supplied with an elastomer damper ASED
 The CS 8/...-SD are supplied with a hydraulic shock absorber ASSD
 The CS 8/...-SDH are supplied with a hydraulic shock absorber and with a stop sleeve
 The module can be operated with lubricated or dry air.
 Cleanroom class ISO 14644-1, class ISO 7

Included in the delivery
 (Catalogue HT accessories)

- 2x Centering bushing Ø5x2.5
- 2x Special screw M3x14.8/4
- 2x Special screw M3 x 16/6
- 2x Shock absorber ASSD M5x0.5 -2
- 2x Shock absorber ASED M5x05 -1

Accessories

(Catalogue HT accessories)

- INI c10x28.5-Em-PNP-NO-M8x1

Alternative accessories

(Catalogue HT accessories)

- Steel stop ASS 05/12
- Steel stop ASS 05/22
- Steel stop ASS 05/37
- Steel stop ASS 03/25
- INI d3x22-Sn0.8-PNP-NO-M8x1
- INI c10x19.5-Em-PNP-NO-M8x1

Fig. 3 Table technical data CS 8

* The maximum load capacities are listed in the table in the section Slide loads (➔ slide loads 3.1.6).

Technical data

3.1.4 Technical data CS 8 SDH

CS 8			
Attachment grid	20 x 20 mm		
Attachment thread	M3		
Operating pressure	6 +/- 2 bar		
Air connection P	M5		
Cylinder Ø	2 x 6 mm		
Retract piston force	25 N		
Extend piston force	34 N		
Operating temperature	0 - 50 °C		
Storage temperature	0 - 50 °C		
Humidity	< 90 %		
Medium filtered compressed air	10 - 40 µm		

Type	CS 8/10-SDH	CS 8/30-SDH	CS 8/60-SDH
Order number	50509361	50509609	50509576
Stroke H	10 mm	30 mm	60 mm
Stroke limitation	2 x 10 mm	2 x 25 mm	2 x 25 mm
Net weight	0.181 kg	0.246 kg	0.293 kg
Moving weight	0.07 kg	0.11 kg	0.14 kg
Air consumption/cycle	0.005 NL	0.014 NL	0.027 NL
Noise level	60 dB (A)	60 dB (A)	60 dB (A)
Repeat accuracy	+/- 0.01 mm	+/- 0.01 mm	+/- 0.01 mm
Maximum speed	1 m/s	1 m/s	1 m/s
Minimum speed	0.05 m/s	0.05 m/s	0.05 m/s
Mounting position	✦	✦	✦

The technical data refers to a nominal pressure of 6 bar under Afag standard test conditions. The maximum payloads are listed in the payloads table in the slide loads section.
 Note: the CS 8/...-ED are supplied with an elastomer damper ASED
 The CS 8/...-SD are supplied with a hydraulic shock absorber ASSD
 The CS 8/...-SDH are supplied with a hydraulic shock absorber and with a stop sleeve
 The module can be operated with lubricated or dry air.
 Cleanroom class ISO 14644-1, class ISO 7

Included in the delivery (Catalogue HT accessories)

- 2x Centering bushing Ø5x2.5
- 2x Special screw M3x14.8/4
- 2x Special screw M3 x 16/6
- 2x Shock absorber ASSD M5x0.5 -2
- 2x Shock absorber ASED M5x05 -1

Accessories (Catalogue HT accessories)

- INI c10x28.5-Em-PNP-NO-M8x1

Alternative accessories (Catalogue HT accessories)

- Steel stop ASS 05/12
- Steel stop ASS 05/22
- Steel stop ASS 05/37
- Steel stop ASS 03/25
- INI d3x22-5n0.8-PNP-NO-M8x1
- INI c10x19.5-Em-PNP-NO-M8x1

Fig. 4 Table technical data CS 8 SDH

* The maximum load capacities are listed in the table in the section Slide loads (→ slide loads 3.1.6).

3.1.5 Preferred combinations CS 8

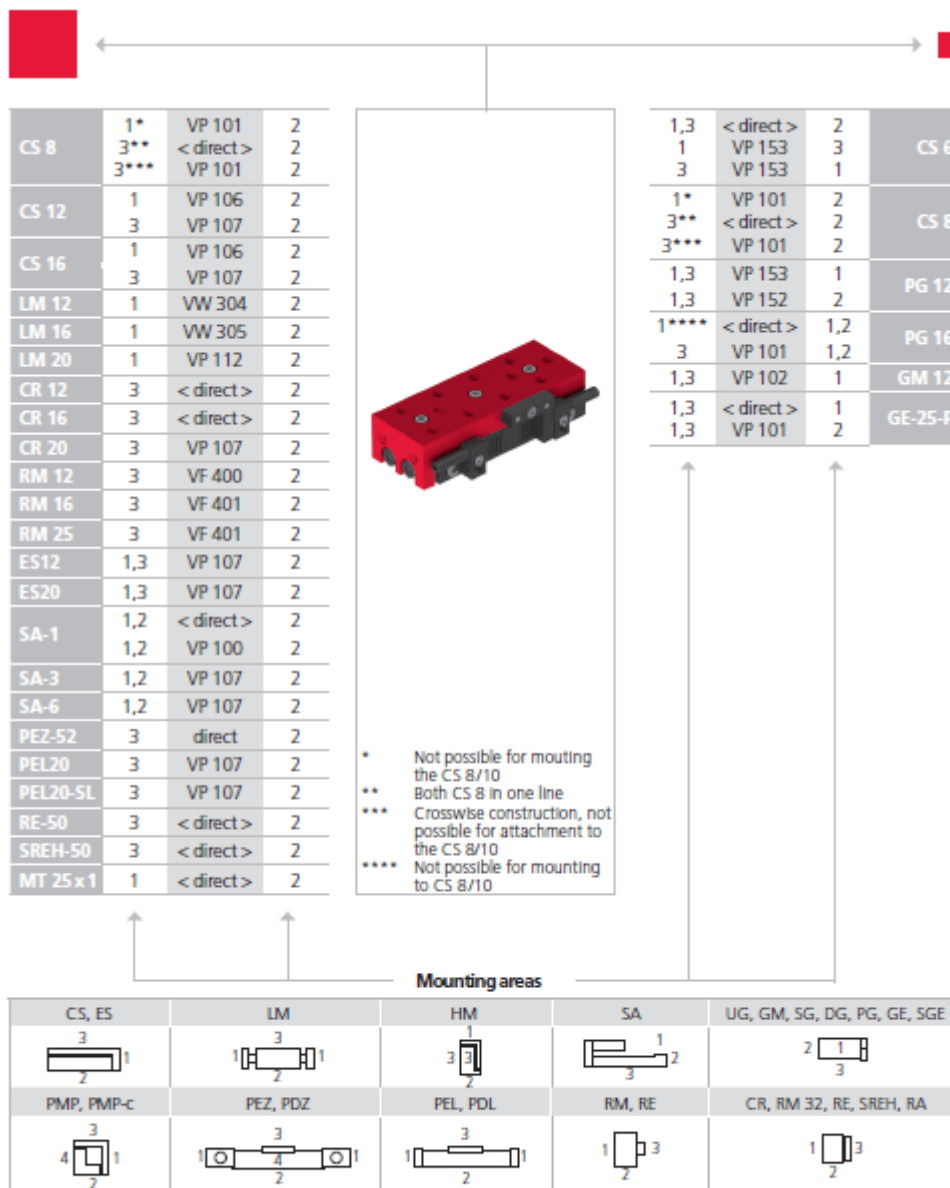

Note that there might be different mounting positions from one module to another one.

The required connection elements and the range of support columns are depicted in the catalogue HT accessories.

Technical data

3.1.6 Slide loads CS 8

Type	CS 8/10-ED	CS 8/10-SD	CS 8/10-SDH	CS 8/30-ED	CS 8/30-SD	CS 8/30-SDH	CS 8/60-ED	CS 8/60-SD	CS 8/60-SDH
Max. torque Mx	3.6 Nm	3.6 Nm	3.6 Nm	5.4 Nm	5.4 Nm	5.4 Nm	5.4 Nm	5.4 Nm	5.4 Nm
Max. torque My	1.7 Nm	1.7 Nm	1.7 Nm	3.6 Nm	3.6 Nm	3.6 Nm	3.6 Nm	3.6 Nm	3.6 Nm
Max. torque Mz	1.7 Nm	1.7 Nm	1.7 Nm	3.6 Nm	3.6 Nm	3.6 Nm	3.6 Nm	3.6 Nm	3.6 Nm
Effective distance Wx	24 mm	24 mm	24 mm	28 mm	28 mm	28 mm	28 mm	28 mm	28 mm
Effective distance Wy	20 mm	20 mm	20 mm	20 mm	20 mm	20 mm	20 mm	20 mm	20 mm
Effective distance Wz	6.5 mm	6.5 mm	6.5 mm	6.5 mm	6.5 mm	6.5 mm	6.5 mm	6.5 mm	6.5 mm

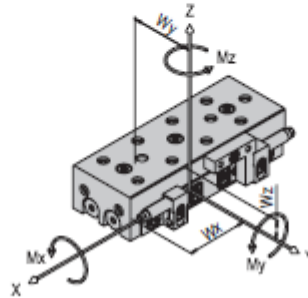

Maximum payload/type	CS 8/10-ED	CS 8/10-SD	CS 8/10-SDH	CS 8/30-ED	CS 8/30-SD	CS 8/30-SDH	CS 8/60-ED	CS 8/60-SD	CS 8/60-SDH
Installation position (horizontal) for mounting side 1	0.2 kg	0.3 kg	0.3 kg	0.2 kg	0.4 kg	0.4 kg	0.2 kg	0.4 kg	0.4 kg
Installation position (horizontal) for mounting side 3	0.2 kg	0.3 kg	0.3 kg	0.2 kg	0.7 kg	0.7 kg	0.2 kg	0.7 kg	0.7 kg
Installation position (vertical) for mounting side 1	0.2 kg	0.3 kg	0.3 kg	0.2 kg	0.4 kg	0.4 kg	0.2 kg	0.4 kg	0.4 kg
Installation position (vertical) for mounting side 3	0.2 kg	0.3 kg	0.3 kg	0.2 kg	0.7 kg	0.7 kg	0.2 kg	0.7 kg	0.7 kg

Assembly sides module mounting

horizontal:

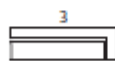

vertical:

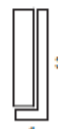

If the specified maximum payloads are exceeded, it must be ensured that the corresponding moments do not affect the service life of the module. All torques are static. In the event of critical applications, please contact Afag.

Fig. 5 Table of slide loads CS 8

3.1.7 Operation time diagram CS 8

Operation time diagrams

CS 8/10-ED elastomer

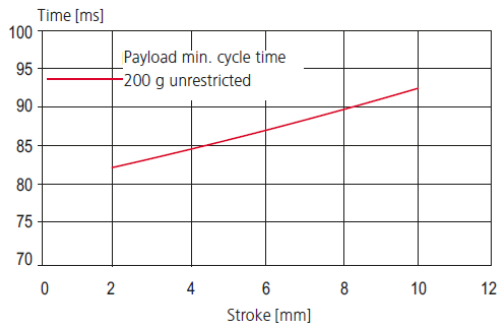

CS 8/10-SD hydraulic

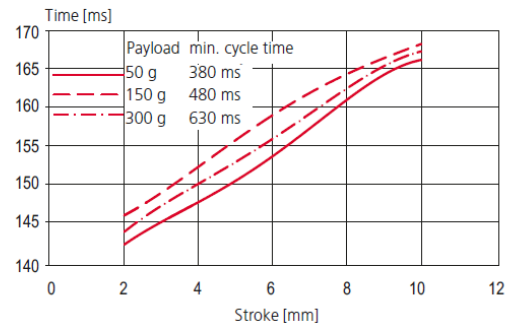

CS 8/30-ED elastomer

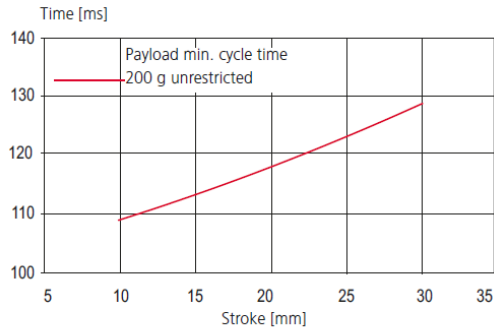

CS 8/30-SD hydraulic

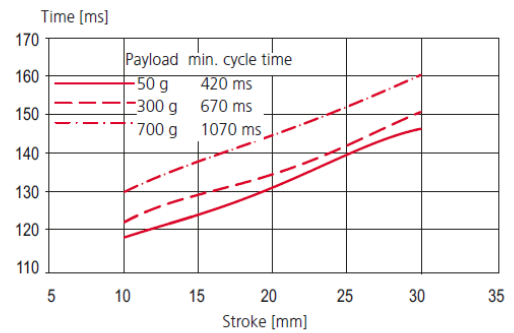

CS 8/60-ED elastomer

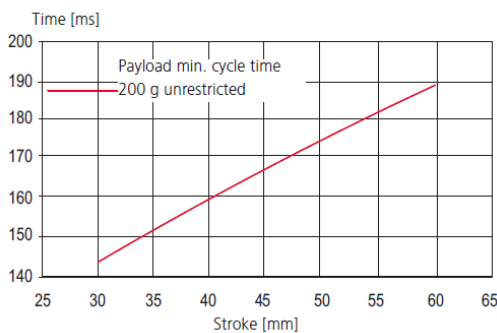

CS 8/60-SD hydraulic

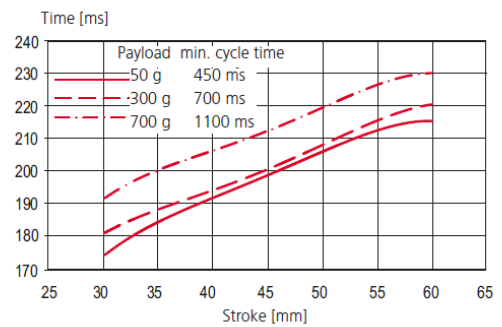

3.2 Compact slide CS 12

3.2.1 Dimensional drawing CS 12

Type	CS 12/30	CS 12/60	CS 12/90
A	102 mm	132 mm	162 mm
B	70 mm	100 mm	130 mm
C	4 x 15 mm	6 x 15 mm	8 x 15 mm
D	4 x 15 mm	6 x 15 mm	8 x 15 mm

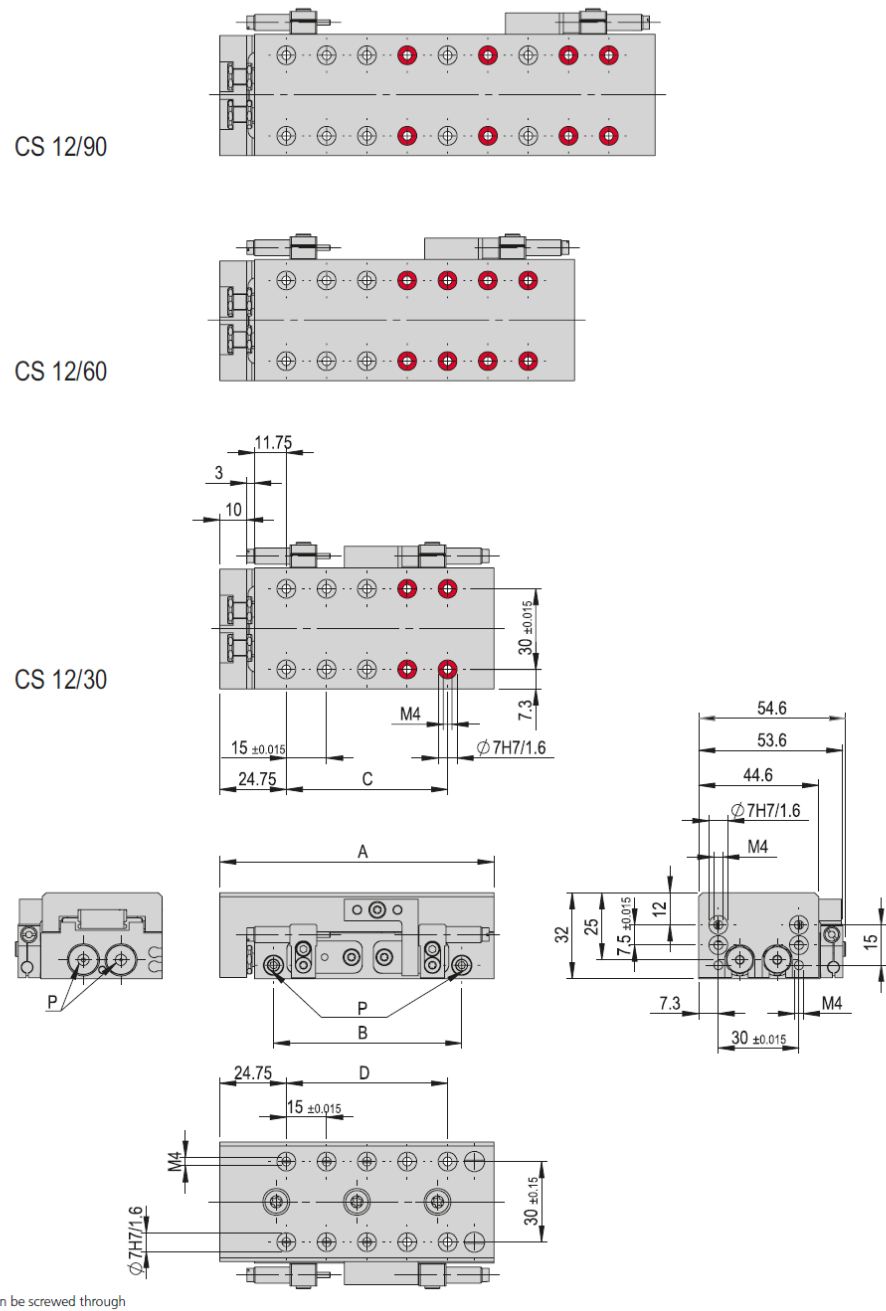
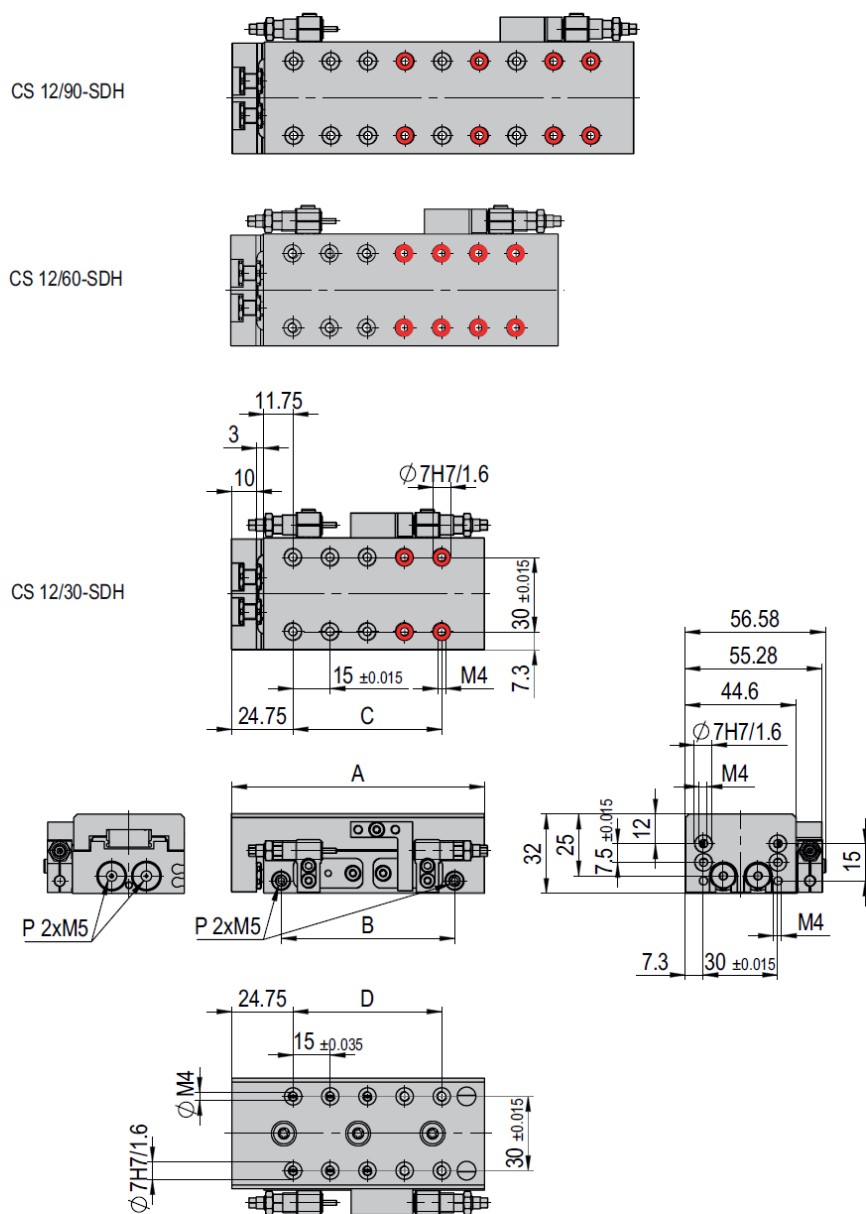

Fig. 6 Dimensional drawing Compact Slide CS 12

3.2.2 Dimensional drawing CS 12 SDH

Type	CS 12/30-SDH	CS 12/60-SDH	CS 12/90-SDH
A	102 mm	132 mm	162 mm
B	70 mm	100 mm	130 mm
C	4 x 15 mm	6 x 15 mm	8 x 15 mm
D	4 x 15 mm	6 x 15 mm	8 x 15 mm



Bores can be screwed through

Fig. 7 Dimensional drawing Compact Slide CS 12 SDH

Technical data

3.2.3 Technical data CS 12

CS 12	
Attachment grid	30 x 30 mm
Attachment thread	M4
Operating pressure	6 +/- 2 bar
Air connection P	M5
Cylinder Ø	2 x 10 mm
Retract piston force	71 N
Extend piston force	94 N
Operating temperature	0 - 50 °C
Storage temperature	0 - 50 °C
Humidity	< 90 %
Medium filtered compressed air	10 - 40 µm

Type	CS 12/30-ED	CS 12/30-SD	CS 12/60-ED	CS 12/60-SD	CS 12/90-ED	CS 12/90-SD
Order number	50300528	50048476	50300529	50050602	50300530	50050825
Stroke H	30 mm	30 mm	60 mm	60 mm	90 mm	90 mm
Stroke limitation	2 x 25 mm	2 x 25 mm	2 x 25 mm	2 x 25 mm	2 x 25 mm	2 x 25 mm
Net weight	0.5 kg	0.5 kg	0.864 kg	0.61 kg	0.73 kg	0.73 kg
Moving weight	0.24 kg	0.24 kg	0.3 kg	0.3 kg	0.36 kg	0.36 kg
Air consumption/cycle	0.038 NL	0.038 NL	0.076 NL	0.076 NL	0.114 NL	0.114 NL
Noise level	64 dB (A)	64 dB (A)	64 dB (A)	64 dB (A)	64 dB (A)	64 dB (A)
Repeat accuracy	+/- 0.01 mm	+/- 0.01 mm	+/- 0.01 mm	+/- 0.01 mm	+/- 0.01 mm	+/- 0.01 mm
Maximum speed	1 m/s	1 m/s	1 m/s	1 m/s	1 m/s	1 m/s
Minimum speed	0.02 m/s	0.02 m/s	0.02 m/s	0.02 m/s	0.02 m/s	0.02 m/s
Mounting position	✦	✦	✦	✦	✦	✦

The technical data refers to a nominal pressure of 6 bar under Afag standard test conditions. The maximum payloads are listed in the payloads table in the slide loads section.
 Note: the CS 12/...-ED are supplied with an elastomer damper ASED
 The CS 12/...-SD are supplied with a hydraulic shock absorber ASSD
 The CS 12/...-SDH are supplied with a hydraulic shock absorber and with a stop sleeve
 The module can be operated with lubricated or dry air.
 Cleanroom class ISO 14644-1, class ISO 7

Included in the delivery

(Catalogue HT accessories)

- 2x Centering bushing Ø7x3
- 4x Special screw M4 x 20/8
- 2x Shock absorber ASSD M6x0.5 - 4
- 2x Shock absorber ASED M6x0.5 - 1

Accessories

(Catalogue HT accessories)

- INI c10x28.5-Em-PNP-NO-M8x1

Alternative accessories

(Catalogue HT accessories)

- Steel stop ASS 04/25
- INI d4x25-5n1.0-PNP-NO-M8x1
- INI c10x19.5-Em-PNP-NO-M8x1

Fig. 8 Table technical data CS 12

* The maximum load capacities are listed in the table in the section Slide loads (→ slide loads 3.2.6).

3.2.4 Technical data CS 12 SDH

CS 12 -SDH	
Attachment grid	30 x 30 mm
Attachment thread	M4
Operating pressure	6 +/- 2 bar
Air connection P	M5
Cylinder Ø	2 x 10 mm
Retract piston force	71 N
Extend piston force	94 N
Operating temperature	0 - 50 °C
Storage temperature	0 - 50 °C
Humidity	< 90 %
Medium filtered compressed air	10 - 40 µm

Type	CS 12/30-SDH	CS 12/60-SDH	CS 12/90-SDH
Order number	50509653	50509713	50509725
Stroke H	30 mm	60 mm	90 mm
Stroke limitation	2 x 25 mm	2 x 25 mm	2 x 25 mm
Net weight	0.5 kg	0.61 kg	0.73 kg
Moving weight	0.24 kg	0.3 kg	0.36 kg
Air consumption/cycle	0.038 NL	0.076 NL	0.114 NL
Noise level	64 dB (A)	64 dB (A)	64 dB (A)
Repeat accuracy	+/- 0.01 mm	+/- 0.01 mm	+/- 0.01 mm
Maximum speed	1 m/s	1 m/s	1 m/s
Minimum speed	0.02 m/s	0.02 m/s	0.02 m/s
Mounting position	✦	✦	✦

The technical data refers to a nominal pressure of 6 bar under Afag standard test conditions. The maximum payloads are listed in the payloads table in the slide loads section.
 Note: the CS 12/...-ED are supplied with an elastomer damper ASED
 The CS 12/...-SD are supplied with a hydraulic shock absorber ASSD
 The CS 12/...-SDH are supplied with a hydraulic shock absorber and with a stop sleeve
 The module can be operated with lubricated or dry air.
 Cleanroom class ISO 14644-1, class ISO 7

Included in the delivery

(Catalogue HT accessories)

- 2x Centering bushing Ø7x3
- 4x Special screw M4 x 20/8
- 2x Shock absorber ASSD M6x0.5 - 4
- 2x Shock absorber ASED M6x0.5 - 1

Accessories

(Catalogue HT accessories)

- INI c10x28.5-Em-PNP-NO-M8x1

Alternative accessories

(Catalogue HT accessories)

- Steel stop ASS 04/25
- INI d4x25-5n1.0-PNP-NO-M8x1
- INI c10x19.5-Em-PNP-NO-M8x1

Fig. 9 Table technical data CS 12

* The maximum load capacities are listed in the table in the section Slide loads (→ slide loads 3.2.6).

3.2.5 Preferred combinations CS 12

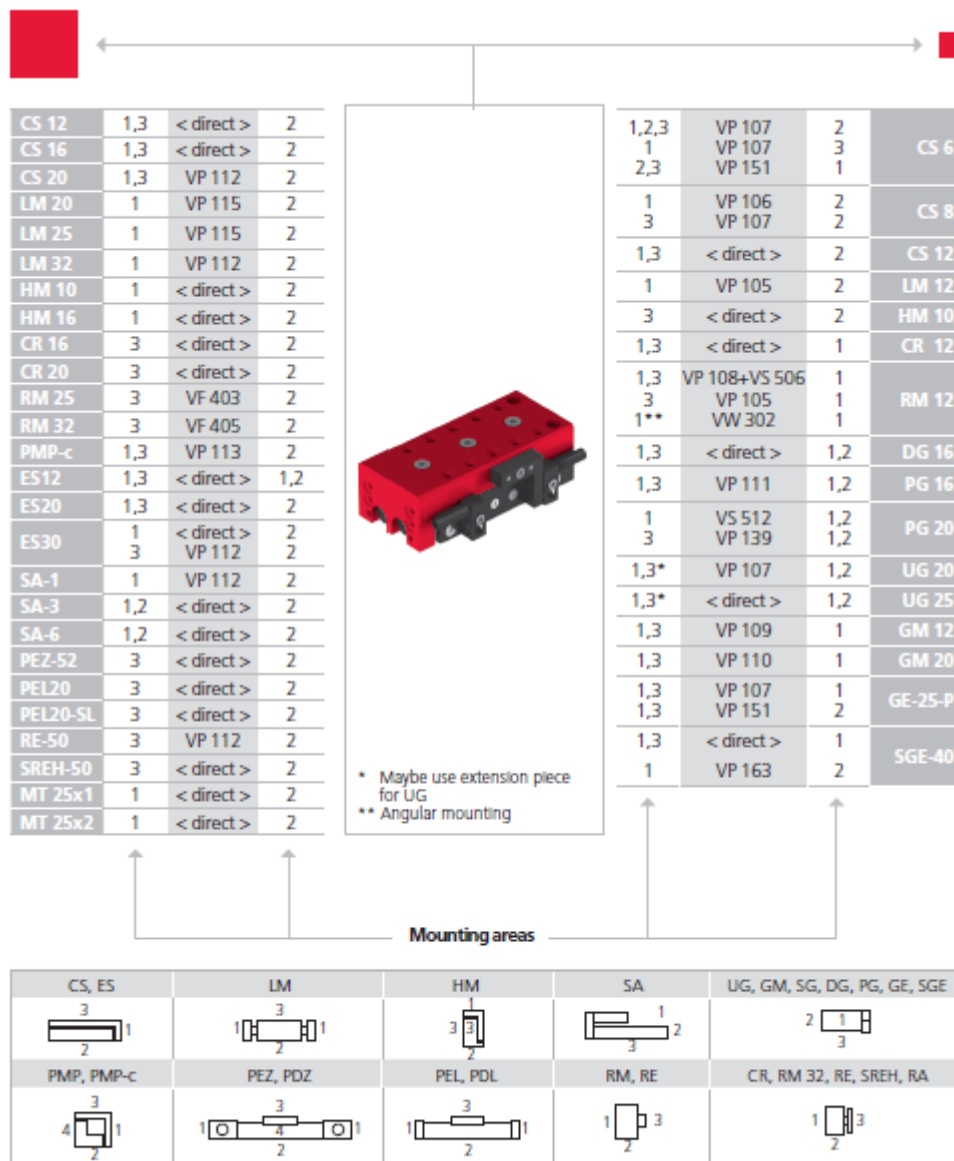

Note that there might be different mounting positions from one module to another one.

The required connection elements and the range of support columns are depicted in the catalogue HT accessories.

3.2.6 Slide loads CS 12

Type	CS 12/30- ED	CS 12/30- SD	CS 12/30- SDH	CS 12/60- ED	CS 12/60- SD	CS 12/60- SDH	CS 12/90- ED	CS 12/90- SD	CS 12/90- SDH
Max. torque Mx	13 Nm	13 Nm	13 Nm	13 Nm	13 Nm	13 Nm	13 Nm	13 Nm	13 Nm
Max. torque My	8 Nm	8 Nm	8 Nm	8 Nm	8 Nm	8 Nm	8 Nm	8 Nm	8 Nm
Max. torque Mz	8 Nm	8 Nm	8 Nm	8 Nm	8 Nm	8 Nm	8 Nm	8 Nm	8 Nm
Effective distance Wx	36.5 mm	36.5 mm	36.5 mm	36.5 mm	36.5 mm	36.5 mm	36.5 mm	36.5 mm	36.5 mm
Effective distance Wy	26 mm	26 mm	26 mm	26 mm	26 mm	26 mm	26 mm	26 mm	26 mm
Effective distance Wz	22 mm	22 mm	22 mm	22 mm	22 mm	22 mm	22 mm	22 mm	22 mm

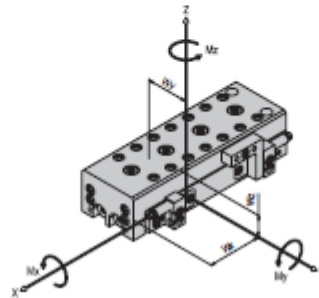

Maximum payload/type	CS 12/30- ED	CS 12/30- SD	CS 12/30- SDH	CS 12/60- ED	CS 12/60- SD	CS 12/60- SDH	CS 12/90- ED	CS 12/90- SD	CS 12/90- SDH
Installation position (horizontal) for mounting side 1	0.3 kg	0.7 kg	0.7 kg	0.3 kg	0.7 kg	0.7 kg	0.3 kg	0.7 kg	0.7 kg
Installation position (horizontal) for mounting side 3	0.3 kg	1.2 kg	1.2 kg	0.3 kg	1.2 kg	1.2 kg	0.3 kg	1.2 kg	1.2 kg
Installation position (vertical) for mounting side 1	0.3 kg	0.7 kg	0.7 kg	0.3 kg	0.7 kg	0.7 kg	0.3 kg	0.7 kg	0.7 kg
Installation position (vertical) for mounting side 3	0.3 kg	1.2 kg	1.2 kg	0.3 kg	1.2 kg	1.2 kg	0.3 kg	1.2 kg	1.2 kg

Assembly sides module mounting

horizontal:

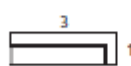

vertical:



If the specified maximum payloads are exceeded, it must be ensured that the corresponding moments do not affect the service life of the module. All torques are static. In the event of critical applications, please contact Afag.

Fig. 10 Table of slide loads CS 12

3.2.7 Operation time diagram CS 12

Operation time diagrams

CS 12/30-ED elastomer

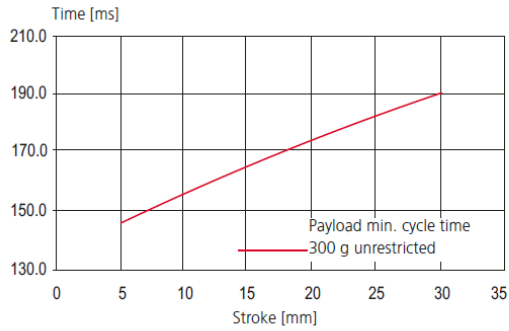

CS 12/30-SD hydraulic

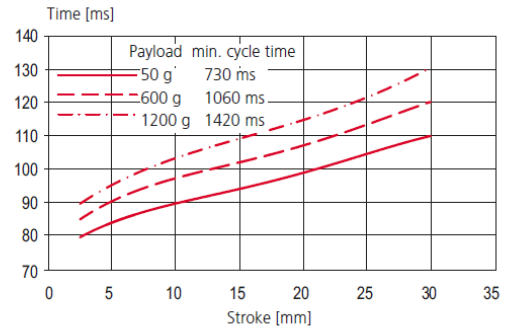

CS 12/60-ED elastomer

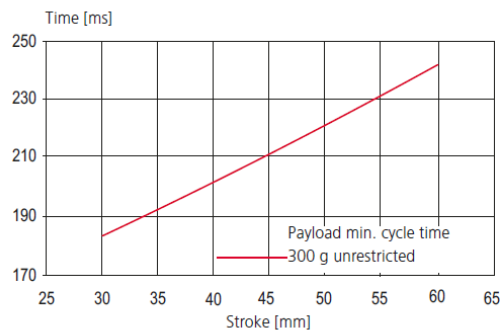

CS 12/60-SD hydraulic

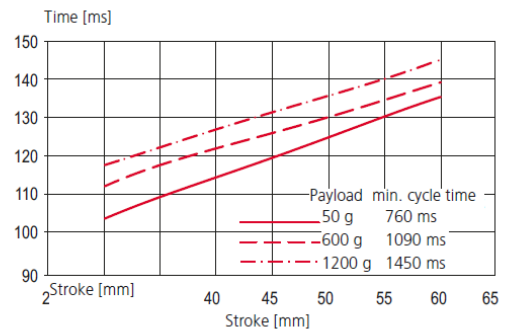

CS 12/90-ED elastomer

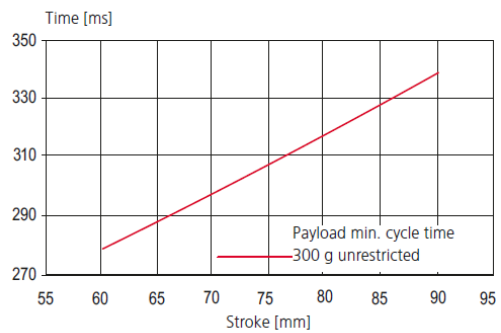

CS 12/90-SD hydraulic

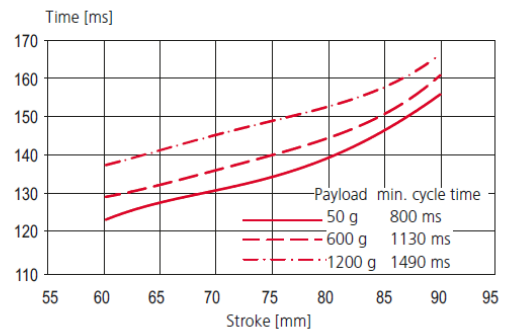

4 Transport, packaging and storage

This chapter provides information regarding proper transport, packaging and storage of the compact slides.

4.1 Safety instructions for transport

CAUTION



Danger of injury when unpacking the CS modules!

The compact slides are packed in the original packaging (cardboard box). If handled incorrectly, the module may fall out of the box when unpacked and cause limb injuries.

- Carefully unpack the compact slides.



Fig. 11 CS Compact Slide in original packaging

NOTICE

Risk of material damage to shock absorbers!

The shock absorbers integrated in the CS modules are precision mechanical parts which can be damaged by careless handling.

- Handle the shock absorbers with care.



Also observe the safety instructions in ➔ Chap. 2 „Safety instructions“ in this manual.

4.2 Scope of supply



The compact slides are supplied with an operating and assembly manual and a safety data sheet (see scope of supply below).

Ut.	CS 8	Ut.	CS 12
1 x	Module CS 8	1 x	Module CS 12
2 x	Shock absorber ASSD M5x0.5-2	2 x	Shock absorber ASSD M6x0.5-1
2 x	Centering bushing Ø 5x2.5 mm	2 x	Centering bushing Ø 7x3 mm
2 x	Special screw M3x14.8/4 mm	4 x	Special screw M4x20/8 mm
2 x	Special screw M3x16 mm	2 x	Shock absorber ASED M6x0.5-1
2 x	Shock absorber ASED M5x0.5-1		

4.3 Transport



No liability can be assumed for damages caused by improper installation on the part of the operating company.







The following conditions must be complied with for transport and storage:

- Storage temperature: 0-50 °C
 - Relative air humidity: < 90%, non condensing
-

4.4 Packaging

The compact slides are packed in the most appropriate manner.

Standardized symbols for packages

Symbol	Note	Explanation
	Top	The package shall be transported, handled and stored with the arrows always pointing upwards (top side of the package).
	Fragile	Products marked with this symbol shall be handled with care and may never be turned upside down or tied up.
	Protect against moisture	The packages shall be protected against moisture and kept dry (keep covered during storage).
	Attachment points	The hosting equipment (chain, etc.) may only be attached to the points marked by this symbol.
	Centre of gravity	This symbol marks the centre of gravity of the packages (pay attention to the position of the centre of gravity).

NOTICE

Risk to the environment due to incorrect disposal of the packaging material.

Environmental damage can be caused by incorrect disposal of the packaging material.

- Dispose of the packaging material in an environmentally sensitive way in accordance with the local environmental regulations.

4.5 Storage

If the compact slide is stored for an extended period of time, observe the following:

- Do not store the compact slides outdoors or expose them to weather conditions.
- The storage space must be dry and dust free.
- Room temperature of the storage space: 0-50 °C.
- Relative air humidity: < 90% non condensing.
- Clean the compact slide and protect the blank metal parts against corrosion using the appropriate means.
- Protect the compact slide from dirt and dust.

5 Design and description

This chapter provides an overview of the compact slide structure and functioning.

5.1 Design compact slide - CS8 and CS12 with SDH

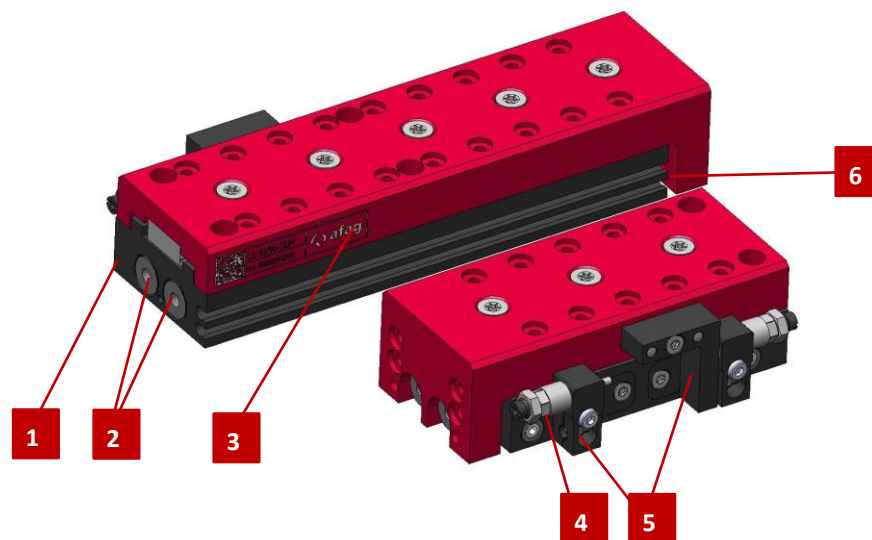

Fig. 12 Design of the CS module

- | | |
|-------------------------|--|
| 1. Base body | 4. Stop sleeve with shock absorber |
| 2. Pneumatic connection | 5. Application for sensors |
| 3. Slide | 6. C-slot for electr. proximity switch |



The shock absorbers used are precision-engineered parts. Do not overtighten the fixing screw, otherwise the shock absorber may be damaged!

5.2 Product description

Compact slides of the CS 8 and CS 12 series are precision devices. In order ensure safe and reliable operation it is important that the modules are handled with care.

The compact slides are highly compact, pneumatic modules and are used for the shock-free linear movement of permanently mounted loads in the defined ambient and operating conditions.

The assembly position of the compact slide can be vertical or horizontal.

The CS 8 - CS 12 modules consist of the base body (Fig. 10, 1) with the pneumatic connections and the cylinder that moves the slide (Fig. 10, 2). The end positions are each adjusted via a stop screw with integrated shock absorber.

The end position can optionally be sensed by means of an inductive switch (not included in the scope of delivery, ➔ Chap. 5.3 „Accessories“).

5.3 Accessories CS 8 and CS 12

Article	Order Number
Centring bushing Ø4x2 mm	50035831 (CS 8)
Centring bushing Ø5x2.5x10.5 mm	11016850 (CS 12)
Initiator INI c10x28.5-Em-PNP-close-M8x1	50033432 (CS 8 + CS 12)
Initiator INI d3x22-Sn0.8-PNP-close-M8X1	50001023 (CS 8) Alternative
Elastomer shock absorber ASER M5x0.5-1	50282683 (CS 8)
Elastomer shock absorber ASER M6x0.5-1	50298509 (CS 12)
Elastomer shock absorber ASSD M5x0.5-2	50046138 (CS 8)
Elastomer shock absorber ASSD M6x0.5-1	50048428 (CS 12)
Damping element	50286941 (CS 8)+(CS 12)
Steel stop ASS 05/12	50036780 (CS 8/10)
Steel stop ASS 05/22	50045855 (CS 8/10)
Steel stop ASS 05/37	50046516 (CS 8/10)
Steel stop ASS 03/25	50465413 (CS 8)
Steel stop ASS 04/25	50465467 (CS 12)
'Connecting plate VP 101	50041054 (CS 8)
'Connecting plate VP 107	50041056 (CS 12)
'Connecting plate VP 106	50077110 (CS 12)
Special screws M3x16/6 mm (2 pces)	50035812 (CS 8)
Special screws M3x14.8/4 (2 pces)	50473379 (CS 8)
Special screws M3x25/8 mm (2 pces)	50101005 (CS 12)
Socket wrench screwdriver for ASSD 05	50110796 (CS 8)
Socket wrench screwdriver for ASSD 06	50110797 (CS 12)
SDH-Support CS 8	50568020 (CS 8)
SDH-Support CS 12	50568150 (CS 12)



You will find more information on the accessories for the compact slides on our website www.afag.com.

6 Installation, assembly & setting

This chapter contains specific safety instructions and information regarding proper installation, assembly and setting of the compact slides including their connection to the control unit and the pneumatic system.

6.1 Safety Instructions for Installation & assembly

CAUTION



Danger of injury when connecting the compact slide to the control unit and the compressed-air system!

When connecting the compact slides to the control unit or the compressed-air system sudden, unpredictable movements may occur which can cause personal injury or property damage.

- Installation may only be carried out by a qualified specialist!
 - Read carefully the assembly and safety instructions before working with or on the compact slides.
-

CAUTION



Danger of injury when handling the compact slides!

Careless handling of the compact slides can cause personal injuries and damage to the modules.

- Only qualified personnel may work with or on the module!
 - Observe the assembly instructions!
-

NOTICE

No liability for damages can be assumed for damages caused by improper installation/assembling work on the part of the operator.



Also observe the safety instructions in  chap. 2 „Safety instructions“ in this manual.

6.2 Installation and assembly

6.2.1 Assembly and attachment



The compact slides can be mounted both in horizontal and vertical position.

CAUTION



Risk of injuries due to uncontrolled parts movements!

When installed in a vertical position, unexpected movements may occur if the compact slide is not in its lowest position.

- When installing in a vertical position, always move the slide to the lowest position before mounting.

Fastening possibilities CS 8 / CS 12

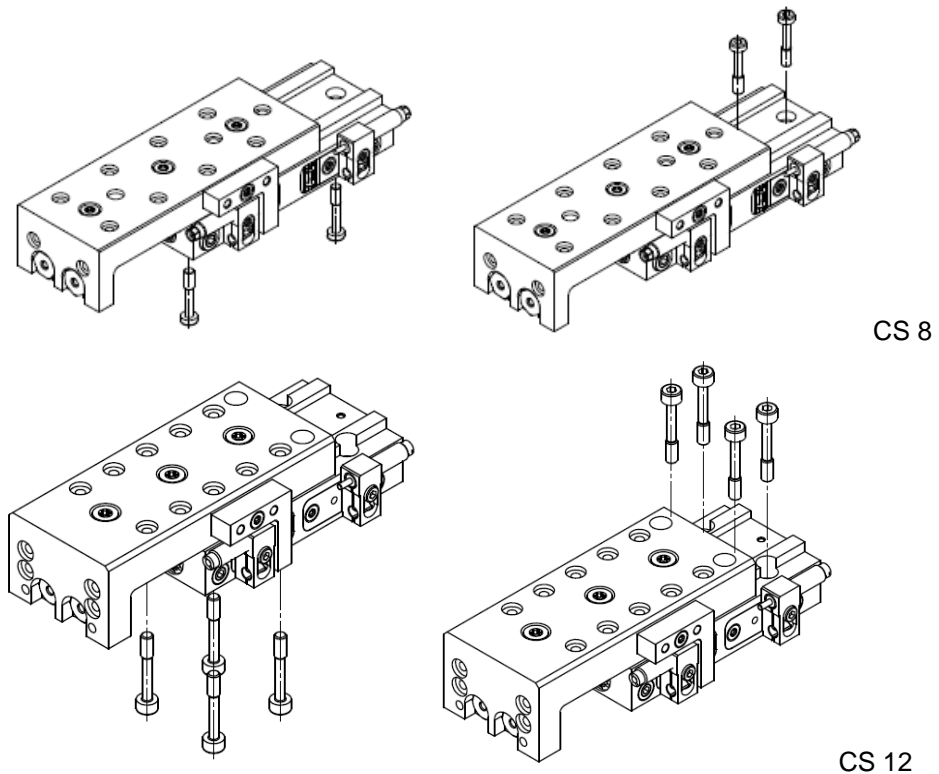

Fig. 13 *Mounting base body from below* *Mounting base body screwed through*

Centering bushing and hole grid

	CS 8	CS 12
Hole grid	20 x 20 mm	30 x 30 mm
Thread/Bore	M3	M4
Centering bushing (H7)	5 x 2.5 mm	7 x 3 mm



To position the compact slides, use the centering sleeves supplied with them (➡ Chapter 5.3 „Accessories“). Insert the centering bushings in two diagonally opposite holes of the attachment grid.

Centering bushings	Ø4x2	Ø5x2.5	Ø7x3	Ø8x3.5	Ø9x4	Ø12x4.8	Ø19x5.8
Order number	50332257	50035831	11016850	50263565	11004942	50187424	50189497
Net weight	0.001 kg	0.001 kg	0.001 kg	0.001 kg	0.001 kg	0.002 kg	0.006 kg
A	4 mm	5 mm	7 mm	8 mm	9 mm	12 mm	19 mm
B	2 mm	2.5 mm	3 mm	3.5 mm	4 mm	4.8 mm	5.8 mm
C	2.6 mm	3.2 mm	4.3 mm	5.4 mm	6.5 mm	8.5 mm	13 mm

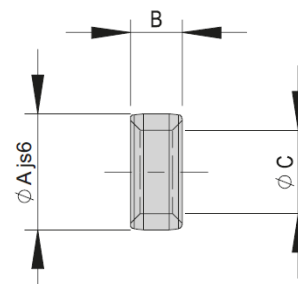

Attachment grid	16x16 mm	20x20 mm	30x30 mm	38x38 mm	48x48 mm	60x60 mm	75x75 mm	96x96 mm
A	16 mm	20 mm	30 mm	38 mm	48 mm	60 mm	75 mm	96 mm
B	8 mm	10 mm	15 mm	19 mm	24 mm	30 mm	38 mm	48 mm
C	4x1.1 mm	5x1.3 mm	7x1.6 mm	8x1.8 mm	9x2.1 mm	12x2.5 mm	15x2.7 mm	19x3 mm
D	M2.5	M3	M4	M5	M6	M8	M10	M12

Module-centering, centering bushings

In order to guarantee a high and repetitive fit accuracy during installation, operation or replacement of a module, all components of the entire program are consequently provided with a precise module centering. Centering bushings or pins are supplied as standard with each module.

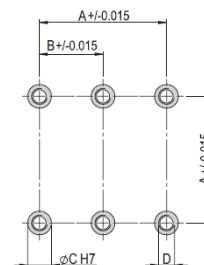
6.2.2 Tightening torques for screws

Use screws with the following minimum specifications for mounting:

Standard	VDI 2230
Screw strength	Category 8.8
Surface:	Galvanized blue, oiled or greased

Thread	Tightening torque
M3	1.1 ... 1.4 Nm
M4	2.6 ... 3.3 Nm
M5	5.2 ... 6.5 Nm
M6	9.0 ... 11.3 Nm
M8	21.6 ... 27.3 Nm

6.2.3 Connection to the pneumatic system

WARNING



Danger when connecting to pneumatics!

The pneumatic system can pose various hazards that can cause serious or fatal injuries if the work is carried out improperly.

- Only qualified personnel may work with or on the pneumatic system!
- The required protective equipment shall be provided and used.

NOTICE

Functional impairment to leaking compressed air connections!

Unused air connections that are not hermetically sealed lead to a pressure loss and thus to functional impairment.

- Before installing the module in a system, all unused compressed air connections must hermetically sealed.
- Perform a leak test!



When connecting the compressed air supply for the first time, make sure that all compressed air throttles are closed.

Vent the system slowly!



The minimum compressed air quality shall comply with the specifications of ISO 8573-1:2010.

Pneumatic connections

The CS 8/30, CS 8/60, CS 12/30 and CS 12/90 each have two pneumatic connections (M5) on the side and rear of the base body. The CS 8/10 has two pneumatic connections at the rear.

The unused pneumatic connections must be sealed airtight with the supplied screw plugs.

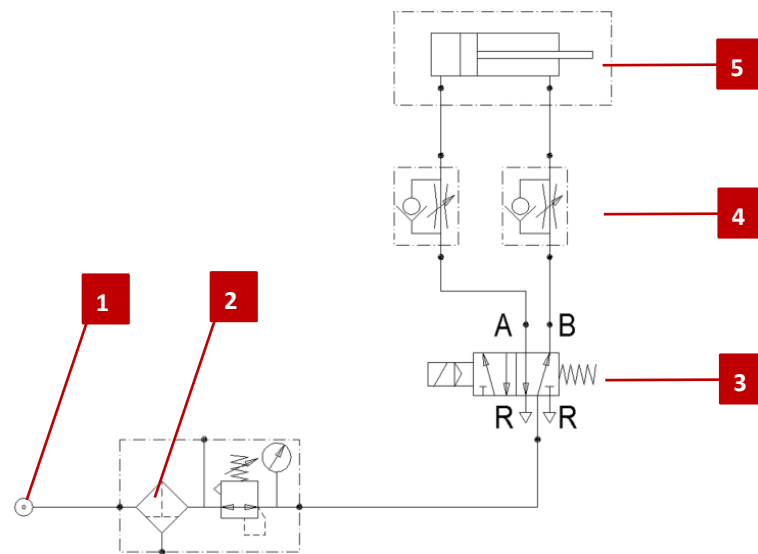

Fig. 14 Pneumatic circuit diagram compact slide (5/2)

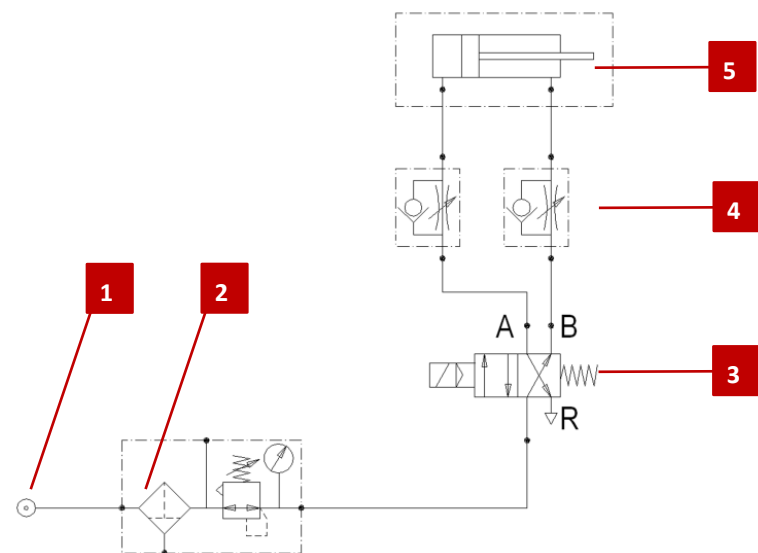

Fig. 15 Pneumatic circuit diagram compact slide (4/2)

- | | |
|------------------------------|------------------------------------|
| 1. Compressed air connection | 4. Throttle check valve (optional) |
| 2. Maintenance unit | 5. Compact Slide CS 8 / CS 12 |
| 3. 4/2 (5/2) Way-valve | |

6.3 Installation and adjustment of the proximity switch

Inductive proximity switches can also be mounted on the shock absorber side. These proximity switches are not included in the scope of delivery (see Accessories).

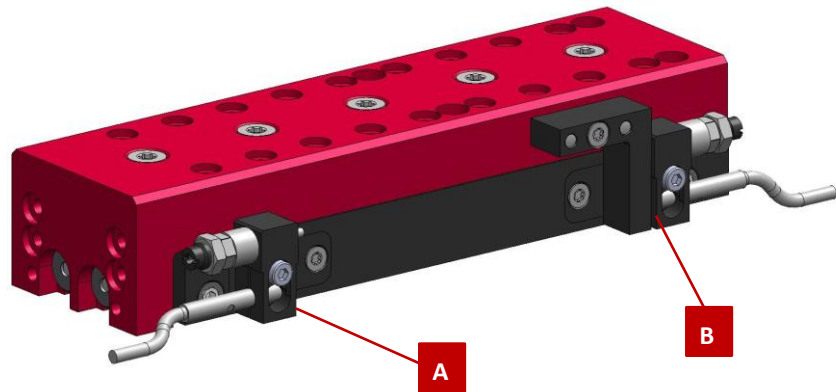

Fig. 16 Installation and adjustment Compact slide

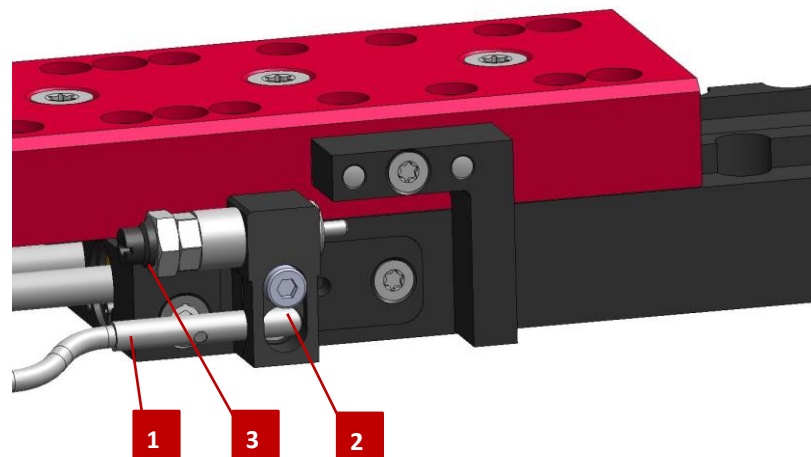

Fig. 17 Installation and adjustment Compact slide

Mounting the proximity switch

Proceed as follows to install the sensors:

1. Screw the initiator (Fig. 15, 1) with the clamping sleeve (Fig. 15, 2) into the receptacle A and B (Fig. 14).
2. Adjust and tighten the initiator (Fig. 15, 1) together with the shock absorber (Fig. 15, 3).
3. Connect the proximity switch to the control system.
4. Perform a functional check of the proximity switch.
 - ⇒ The proximity switch is mounted.

6.4 Query sensors



Proximity switches and initiators are not included in the scope of delivery (see accessories).

Only use the specified proximity switches and initiators!



Function monitoring during end position sensing is performed via an LED on the proximity switch.

If the LED does not change its switching state during the end position sensing, the proximity switch is incorrectly set or defective and must be reset or replaced (➔ Chapter 8.3 Troubleshooting). In addition, the ring magnet may be missing or defective.

INI c10x28.5-Em-PNP-NO-M8x1

Order number	50033432
Net weight	0.02 kg
Operating voltage	10 - 30 VDC

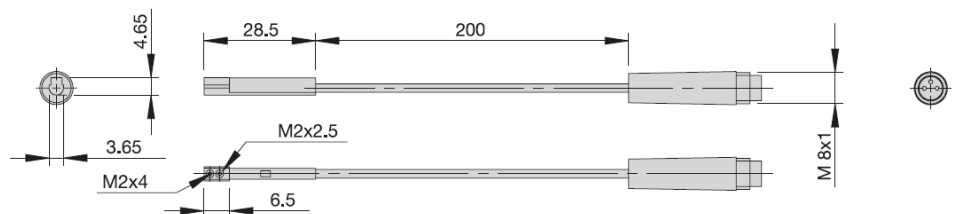

INI c10x19.5-Em-PNP-NO-M8x1

Order number	50313987
Net weight	0.021 kg
Operating voltage	10 - 30 VDC

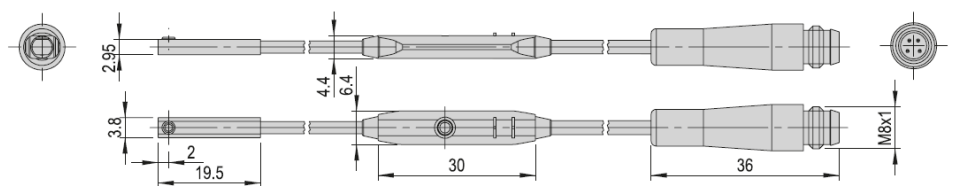

Magnetic cylinder sensor for easy teaching of 2 monitoring positions



In combination with magnetic field producing modules, interference may occur when using the magnetic sensors.

6.5 Adjustment of the shock absorber

This chapter contains information on adjusting the shock absorbers (➔ Chapter 5.3 „Accessories“).

NOTICE

No liability can be assumed for damages caused by improper work carried out on the compact slides on the part of the operator.

6.5.1 Safety notes for settings

WARNING



Danger of injury due to uncontrolled movement of the equipment!

Uncontrolled movements of parts can cause injury to third parties and damage to property.

- Ensure that there are no persons in the working area of the compact slides.

CAUTION



Danger arising from work carried out improperly!

Improper adjustment work can cause injuries and damage to property.

- Adjustment and conversion work may only be carried out by qualified personnel!
- When working on the compact slides, make sure that the control unit and the pneumatic system are switched off and secured against being switched on again.



Also observe the safety instructions in ➔ Chapter 2 „Safety instructions“ in this manual.

6.5.2 Adjustment of the elastomer shock absorber



- The elastomer shock absorber may be operated with a max. load of 0.2 kg on the CS 8.
- Do not use the CS 12 module with elastomer shock absorber in unthrottled operation!

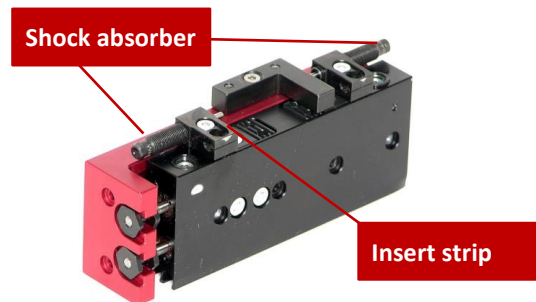

Fig. 18 Adjustment of the shock absorber

The energy values in the technical data apply with the adjustment pin fully screwed in, i.e. with the maximum stroke set (stroke max.). With appropriate stroke reduction, the defined fixed end position can still be reached with less energy or with a low drive force (F_A).

By default, this applies to the rear position on the CS 8, since the return stroke force is less than 30 N.

Procedure:

1. Unscrew the adjustment pin until the defined end position is reached with the drive force (F_A) present.
2. Checking the damper in the test run. The slide must not hit hard in the process.

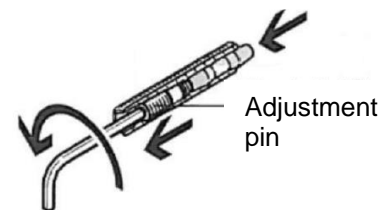

Technical data of elastomer shock absorbers:

Type	Max. Stroke H	Max. Energy	Driving force F_A
ASED M5x0.5-1 (CS 8)	2.8 mm	0.02 J	30 N
ASED M5x0.5-1 (CS 12)	3.1 mm	0.03 J	40 N

NOTICE

Exceeding the specified load capacities will destroy the CS module.

For a clean approach to the end positions, an exhaust air throttle is required to adjust the stroke movement. If the specified operation times are not observed, the slide may be destroyed.



If the desired stroke cannot be set with the shock absorber, the insert strip must be loosened and mounted rotated by 180°.

6.5.3 Adjustment of the hydraulic shock absorber



Before start-up, adjust the shock absorbers so that the slide is damped in the end positions.

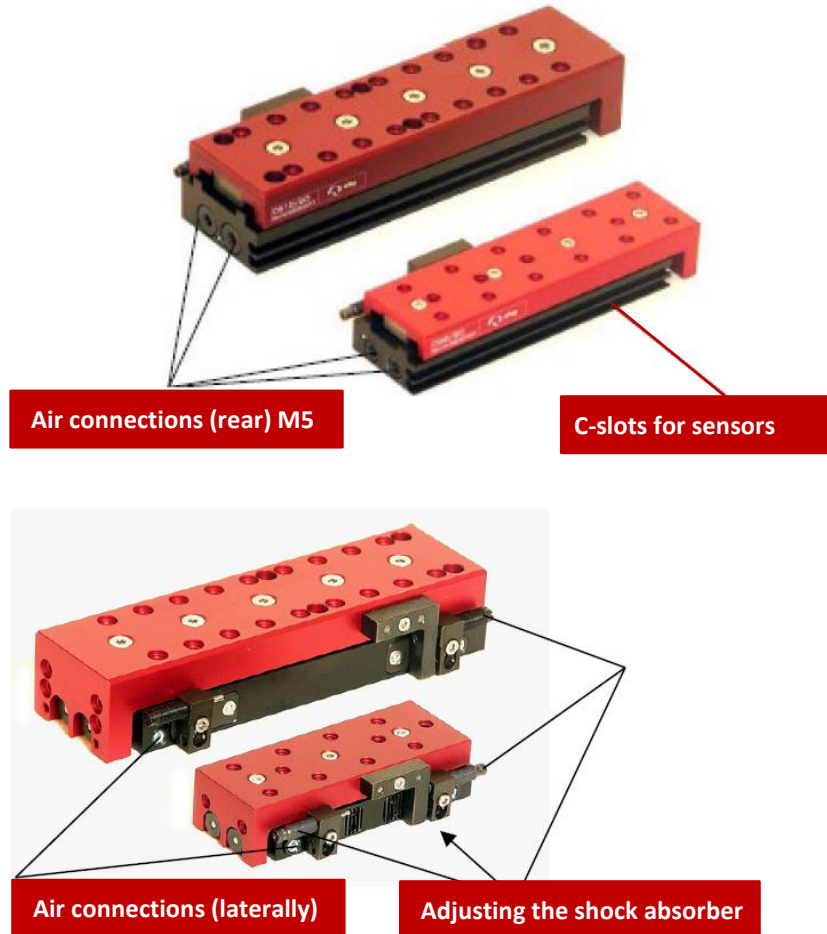
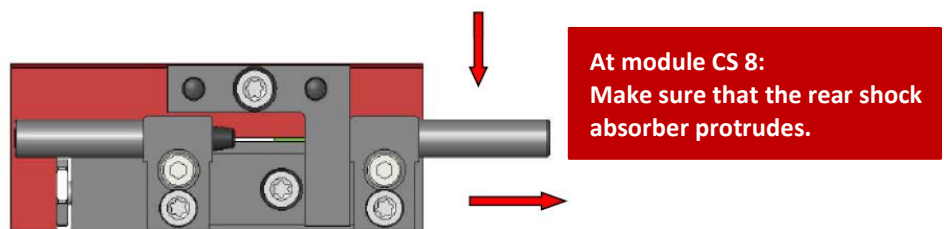

Fig. 19 Adjustment of the hydraulic shock absorber



NOTICE

The CS modules must not be operated without shock absorbers!
 Due to missing damping, the modules can be damaged (The CS modules up to 10 mm stroke, may be operated with stop screws).

6.5.4 Adjusting the shock absorbers and stop screws

Maximum damping effect

Maximum damper effect is achieved when the shock absorbers are fully turned in (mechanical stop).

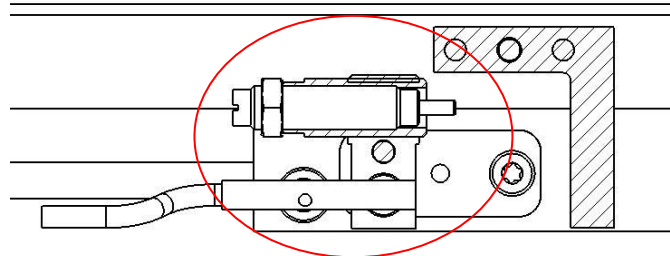

Fig. 20 Maximum damper effect

Reduced damping effect

The damping effect is reduced by turning back the shock absorbers. This is suitable for low loads or slow rotation speeds.

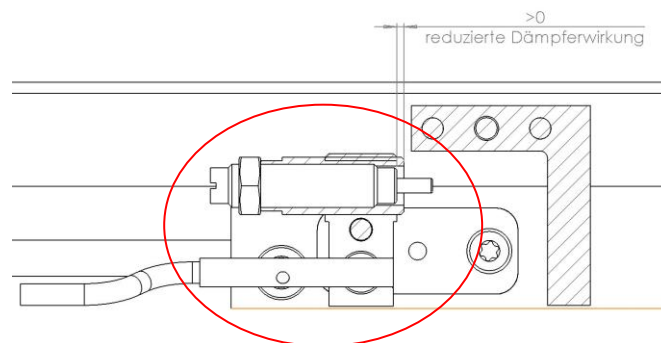

Fig. 21 Reduced damper effect

Replacing the shock absorbers

To replace the shock absorbers, switch off the compressed air supply so that the module does not make any uncontrolled movements.

NOTICE

Exceeding the specified load capacities will destroy the compact slide module.

For a clean approach to the end positions, an exhaust air throttle is required to adjust the stroke movement. If the specified operation times are not observed, the slide may be destroyed.

NOTICE

The CS modules must not be operated without shock absorbers!

Due to the lack of damping, the modules can be damaged.

6.6 End position control for entire stroke range

The installation kit intended for installation is shown below (order number: 50242140!).



Mounting the proximity switch in the ZA module

(1 x Special fixing screws M6, 1 x Lock nut, 1 x Clamping sleeve)

The screw head serves as a reference. The fixing screw provided can be adjusted depending on the combination with the shock absorber. Due to the adjustability of the screw, the end position can be sensed over the entire stroke range by means of an inductive sensor.

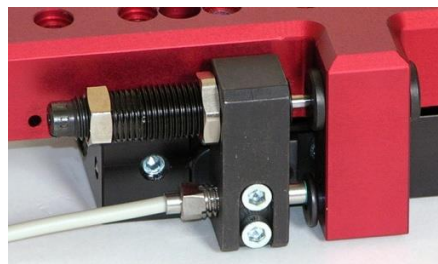

Sensor (adjustable)

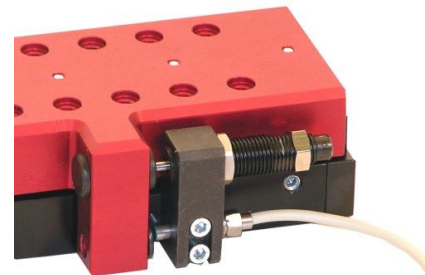

End position sensing

Stroke reduction

If the stroke is to be reduced, the insert strip can be removed and rotated. By screwing in the screw in the middle of the insert bar (see arrow), it is easier to remove the insert bar.

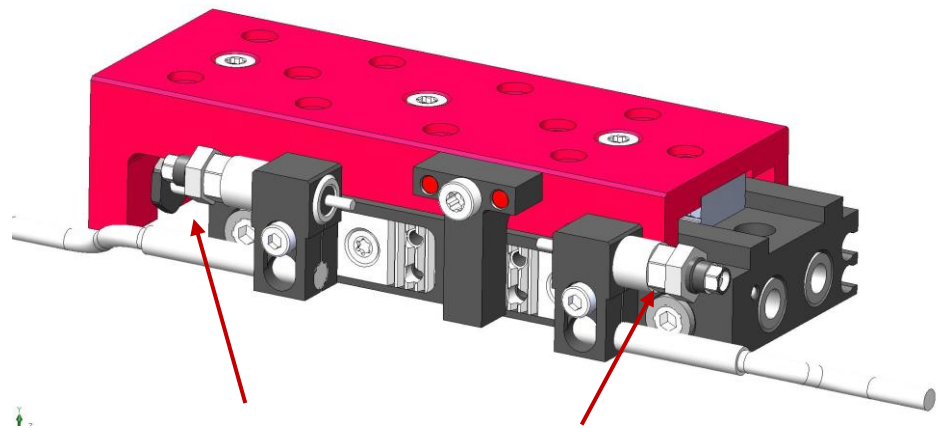

Fig. 22

Stroke reduction (normal)

Reduced stroke

7 Commissioning

This chapter contains information on how to commission the compact slides.

After connection to the pneumatic system and mounting of the sensors, the compact slides are commissioned for the first time via the system control.

7.1 Safety instructions for commissioning

CAUTION



Danger of injury by moving components!

Limbs can be crushed by moving components!

- Work on and with the compact slides may only be carried out by qualified personnel.
- Make sure that there are no persons or tools in the working area of the CS modules.

CAUTION



Danger of injury in the working area of the compact slides!

During operation of the compact slides, persons within the working area of the modules may be injured.

- When operating the compact slides, ensure a good overview of the entire working area.
- Unauthorized persons must not stay within the working area during operation.

NOTICE

Material damage due to operation without shock absorbers!

Operation of the compact slide without shock absorbers leads to mechanical damage and loss of warranty.

- Always operate the compact slide with shock absorbers!



Also observe the safety instructions in  Chapter 2 „Safety instructions“ in this manual.

7.2 Vorbereitungen zur Inbetriebnahme



Abb. 23 Einbau und Einstellung Compact-Schlitten

- | | |
|------------------|------------------|
| 1. Klemmschraube | 4. Schlitten |
| 2. Stossdämpfer | 5. SD-Halter |
| 3. Anschlaghülse | 6. Einsatzleiste |

Vorgehensweise:

1. Druckluft an P1 anschliessen (Abb. 21, P1) (Schlitten ausfahren).
 2. Klemmschraube (Abb. 21, 1) lösen.
 3. Position durch Verdrehen der Anschlaghülse (Abb. 21, 3) einstellen.
 4. Stossdämpfer durch Verdrehen einstellen (Abb. 21, 2).
 5. Klemmschraube (Abb. 21, 1) festziehen.
 6. Druckluft an P2 anschliessen (Abb. 21, P2) (Schlitten einfahren).
 7. Klemmschraube (Abb. 21, 1) lösen.
 8. Position durch Verdrehen der Anlagschraube (Abb. 21, 3) einstellen.
 9. Stossdämpfer durch Verdrehen einstellen (Abb. 21, 2).
 10. Klemmschraube (Abb. 21, 1) festziehen.
- ⇒ Die Vorbereitungen sind abgeschlossen.

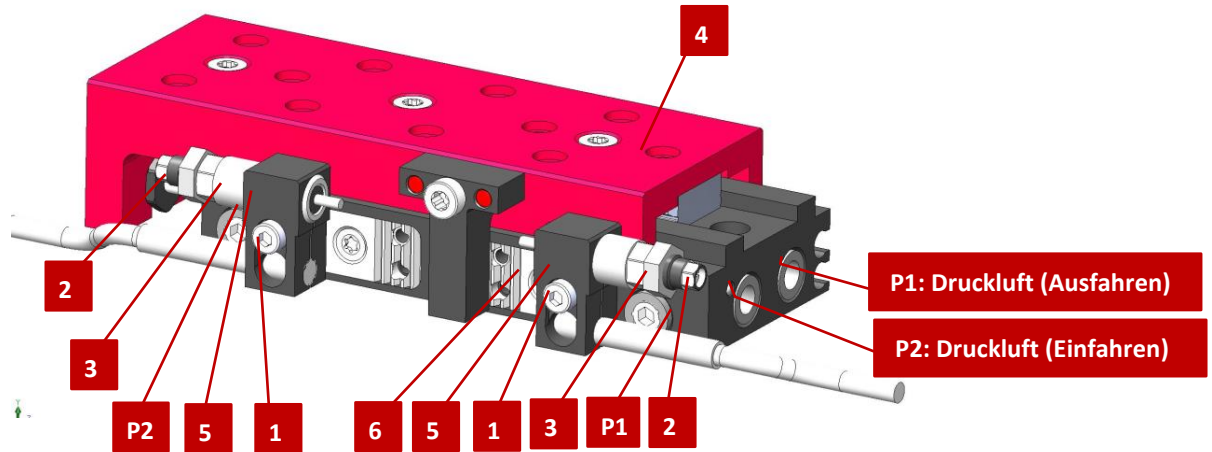
7.3 Commissioning of the modules



Before commissioning, first adjust the stop screws so that the traversing path is delimited. Then adjust the sensors.

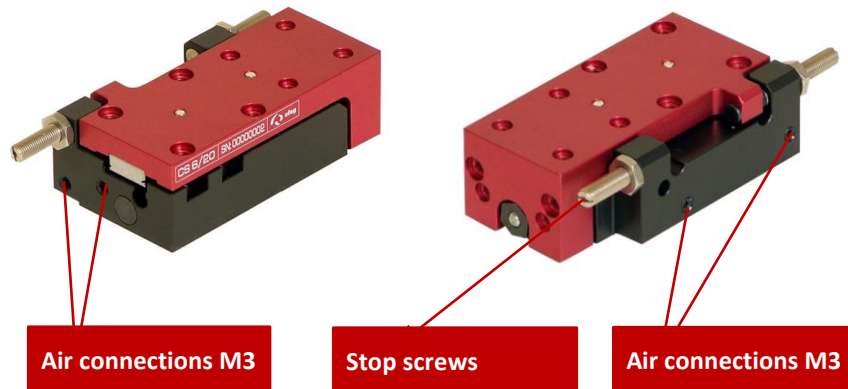

Fig. 24 Commissioning the compact slides

Proceed carefully and follow the instructions step by step when commissioning the modules for the first time:

11. Slowly ventilate the entire system.
 12. Note the permissible values of the compact slide (➔ Chapter 3) for:
 - Payload
 - Movement frequency
 - mechanical stress
 13. Make sure that there are no persons or tools within the working area of the CS module.
 14. Perform test run:
 - Start with slow traversing movements
 - Then continue under normal operating conditions.
- ⇒ Commissioning is completed.

8 Fault elimination

8.1 General Notes

This chapter contains general information and safety instructions for troubleshooting on the compact slide.

8.2 Safety instructions for troubleshooting

WARNING



Danger of injury due to improper work!

Poorly performed troubleshooting work can lead to serious injuries and damage to property.

- The due diligence obligations of the user include ensuring that the personnel working on eliminating faults appropriately trained and qualified.



Also observe the safety instructions in ➡ Chapter 2 „Safety instructions“ in this manual.

8.3 Table Fault causes and remedy

The following table contains an overview of possible fault causes and how to proceed to eliminate them. Defective components must be replaced exclusively by Afag original spare parts.

Fault	Possible cause	Remedy:
The compact slide strikes firmly in the end positions	<ul style="list-style-type: none"> ▪ Stop/shock absorber not set correctly 	<ul style="list-style-type: none"> ▪ Readjust stop/shock absorber
Firmly strike again in the end positions	<ul style="list-style-type: none"> ▪ Damping elements defective 	<ul style="list-style-type: none"> ▪ Replace damping elements (➡ Chap. 5.3 „Accessories“)
The compact slide stops in an end position	<ul style="list-style-type: none"> ▪ No signal on the proximity switch / sensor 	<ul style="list-style-type: none"> ▪ Readjust proximity switch / sensor
The CS module stops again in the end position	<ul style="list-style-type: none"> ▪ Sensor defective 	<ul style="list-style-type: none"> ▪ Replace sensor (➡ Chap. 5.3 „Accessories“)

9 Maintenance and repair

9.1 General notes

The compact slides are almost maintenance-free. Nevertheless, some maintenance work must be carried out to ensure an optimum operating condition of the compact slide. This chapter describes the required maintenance activities.



Each compact slide is accompanied by a safety information sheet. This information sheet must be read carefully by every person who carries out work on and with the compact slide.

9.2 Safety instructions for maintenance and repair

WARNING



Danger of injury due to improper maintenance!

Improperly carried out maintenance activities can cause considerable damage to property and serious injury.

- The operator must exercise due care and only use trained maintenance personnel to carry out the activities.
 - Always wear personal protective equipment when carrying out maintenance and repair work!
-

WARNING



Risk of injury due to uncontrolled movements of the compact slides!

Signals from the control system can trigger unintentional movements of the compact slides, which can cause injury.

- Before starting any work on the compact slide, switch off the control unit and secure to prevent it from being switched on. Observe the operating instructions of the controller used!
 - Before starting any activities, switch off the media supply (pneumatics) and secure it from being switched on again!
-



Also observe the safety instructions in  Chapter 2 „Safety instructions“ in this manual.

9.3 Maintenance activities and maintenance intervals

9.3.1 Overview of the maintenance points

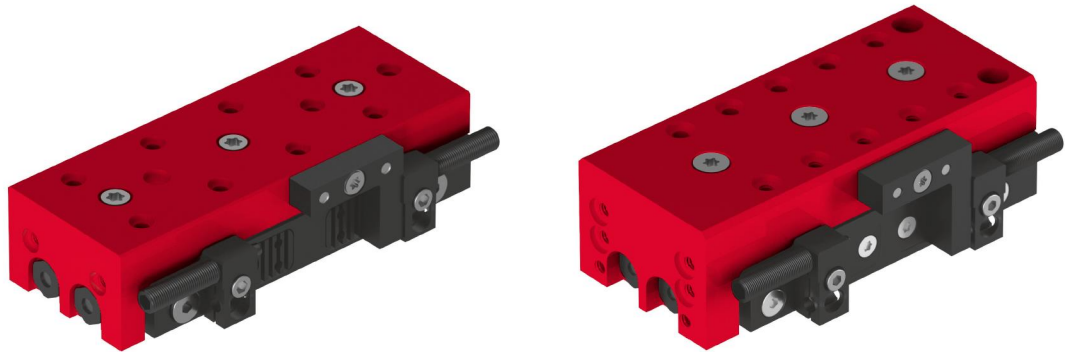





Fig. 25 Maintenance points Compact Slide (CS 8 and CS 12)

No.	Maintenance point	Maintenance work	Interval	System [On/Off]	Remarks
1	Compact Slide	Cleaning 	As required	[Off]	- <ul style="list-style-type: none"> ▪ Clean the compact slide with a dry, lint-free cloth. - do not spray with water - Do not use aggressive cleaning agents.
2	Shock absorber*	Check functioning 	Monthly	[On]	- <ul style="list-style-type: none"> ▪ Check function of shock absorbers, replace if necessary ▪ replacing after max. 5 million load cycles
3	Compact Slide	Check 	Monthly	[On]	- <ul style="list-style-type: none"> ▪ Acoustic control for unusual noise generation



Incorrectly adjusted, missing or defective shock absorbers impair the function of the module and can lead to its destruction!

*Shock absorbers and stop screws must be checked regularly for correct function and replaced if necessary. We recommend replacing the shock absorbers after max. 5 million load cycles.

9.3.2 Compressed air specifications

The compact slides are lifetime lubricated and can be operated with lubricated or non-lubricated compressed air.



Before operating the compact slide with oil-free compressed air, make sure that the module has never been operated with oil-lubricated compressed air!

Compressed air specification
Dry (condensation-free)
Filtered (40 µm filter for lubricated air)
Filtered (5 µm filter for non-lubricated air)

If the compact slides are operated with lubricated compressed air, we recommend that you use the following types of oil:

oil type
Festo Special Oil
Avia Avilub RSL 10
BP Energol HPL 10
Esso Spinesso 10
Shell Tellus Oel C 10
Mobil DTE 21
Blaser Blasol 154

Oil quantity: 5-10 drops of oil per 1000 ltr. Compressed air

Viscosity range: 9 to 11 mm²/s (= cST) at 40°C, ISO class VG 10 according to ISO 3448

NOTICE

Risk of damage to property!

The operation of the compact slides with oil-lubricated compressed air causes the factory primary lubrication to be washed out. Therefore, it is absolutely essential that the compact slides continue to be operated with oil-lubricated compressed air in order to avoid damage to the modules.

- Once the compact slides have been operated with oil-lubricated compressed air, they **may never** be operated without oil-lubricated compressed air.



When using the compact slides in an ionized air environment (e.g. for high-voltage processors/coronization), coat open guides and piston rods with grease to prevent rust formation!

Afag standard lubrication:

- Staburax NBU8EP (flat guides)
- Blasolube 301 (piston rods)

9.3.3 Further maintenance

Further maintenance is not required, if the ambient conditions listed below are complied with:

- Clean working area
- No use of splash water
- No abrasive or process dust and vapours
- Climate and temperature as specified in the technical data

9.4 Spare and wear parts lists, repairs

9.4.1 General notes

Afag Automation AG offers a reliable repair service. Defective modules can be sent to Afag for warranty repair within the warranty period.

After the warranty period has expired, the customer can replace or repair defective modules or wear parts himself or send them to the Afag repair service.



Please note that Afag does not assume any warranty for modules that have not been replaced or repaired by Afag!

9.4.2 Safety instructions

CAUTION

Risk of injury when removing the compact slide due to uncontrolled movements!

When disassembling the compact slides from a system, there is a danger of uncontrolled movements.



- Disconnect the media supply (pneumatics) before removing the modules!
- Disassembling should only be carried out by qualified personnel!
- Bleed and deactivate the equipment before removing the compact slide!
- Before removing the compact slide, switch off the control unit and secure it against being switched on again!

9.4.3 Wear parts for elastomer shock absorbers

The damping elements of the elastomer shock absorbers are wear parts that the customer can easily replace himself.

To do this, the worn damping element is pulled out of the sleeve from the front and the new damping element is also inserted into the sleeve from the front.

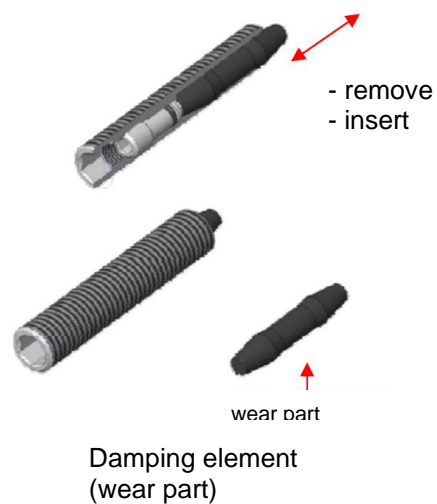

Fig. 26 Replacing the damping elements (elastomer shock absorbers)

10 Decommissioning, disassembly, disposal

The compact slide must be properly dismantled after use and disposed of in an environmentally friendly manner.

10.1 Safety instructions for decommissioning, disassembling and disposal

WARNING



Risk of injury due to improper decommissioning, disassembly and disposal!

Improperly carried out activities can result in considerable material damage and serious injury.

- The operator must exercise due care and only use specially trained and qualified personnel for this work.



Also observe the safety instructions in ➔ Chapter 2 „Safety instructions“ in this manual.

10.2 Decommissioning

If the compact slides are not used for a longer period of time, they must be properly commissioned and stored as described in ➔ Chapter 4.5.

10.3 Disassembly

The compact slides may only be dismantled by qualified personnel.

CAUTION



Risk of injury due to uncontrolled movements of the compact slides!

When disassembling the compact slides from a system, there is a danger of uncontrolled movements. If pneumatic connections are disconnected under pressure, serious bodily injury may result.

- Disconnect the media supply (pneumatics) before removing the compact slides!
- Disassembling should only be carried out by qualified personnel!
- Only remove the compact slide when the control unit is switched off and secured!

10.4 Disposal

The compact slide must be disposed of properly at the end of their service life and the raw materials used must be recycled. Observe the legal regulations and company requirements.

The compact slide must not be disposed of as a complete unit. Dismantle the compact slide and separate the various components according to type of material and dispose of them properly:

- Scrap the metallic materials.
- Hand over plastic parts for recycling.
- Sort the rest of the components by their material properties and dispose of them accordingly.

NOTICE

Risk to the environment due to incorrect disposal of the compact slides!

Environmental damage can be caused by improper disposal of the compact slide.

- Electronic parts, electrical scrap, auxiliary and operating materials must be disposed of by approved specialist companies.
 - Information on proper disposal can be obtained from the responsible local authorities.
-

11 Declaration of incorporation

Declaration of incorporation

for partly completed machinery according to the
Machinery Directive 2006/42/EC, Annex II, 1.B

The manufacturer hereby declares:

Afag Automation AG, Luzernstrasse 32, CH-6144 Zell

that the partly completed machine:

Product description	Compact Slide (pneumatic)
Type:	CS 8, CS 12
Consecutive serial no.	50XXXXXX

complies with the following essential health and safety requirements of the Machinery Directive 2006/42/EC at the time of declaration: 1.1; 1.1.1; 1.1.2; 1.2.3; 1.3.3; 1.3.6; 1.3.7.1.4.1; 1.5; 1.6; 1.6.1; 1.6.2; 1.6.4; 1.7; 1.7.4; 1.7.4.2.

Harmonised standards applied, in particular:	
EN ISO 12100:2010	Safety of machinery - General principles for design - Risk assessment and risk reduction.

Note: The partly completed machinery must not be put into service until the machinery into which it is to be incorporated has been declared in conformity with the provisions of Machinery Directive 2006/42/EC.

The manufacturer undertakes to transmit, in response to a reasoned request by the national authorities, relevant technical documentation for the partly completed machinery.

The relevant technical documentation was created according to Annex VII, Part B of the above-mentioned Directive.

Authorised representative for compiling the technical documentation:

Niklaus Röthlisberger, Product Manager, Afag Automation AG, CH-6144 Zell

Zell, 31.05.2023

Adrian Fuchser



CEO Afag Gruppe

Klaus Bott



CTO Afag Gruppe

Afag Automation AG
Luzernstrasse 32
6144 Zell
Switzerland
T +41 62 959 86 86
sales@afag.com

Afag GmbH
Wernher-von-Braun-Straße 1
92224 Amberg
Germany
T +49 9621 650 27-0
sales@afag.com

Afag Engineering GmbH
Gewerbestraße 11
78739 Hardt
Germany
T +49 7422 560 03-0
sales@afag.com

Afag Automation Americas
Schaeff Machinery & Services LLC.
883 Seven Oaks Blvd, Suite 800
Smyrna, TN 37167
USA
T +1 615 730 7515
nashville@afag.com

Afag Automation APAC
Afag Automation Technology (Shanghai) Co., Ltd.
Room 102, 1/F, Bldg. 56, City Of Elite
No.1000, Jinhai Road, Pudong New District
Shanghai, 201206
China
T +86 021 5895 8065
shanghai@afag.com