



KEYSTONE K-LOK® SERIES 36 AND 37 HIGH PERFORMANCE BUTTERFLY VALVE ISO VERSION INSTALLATION AND OPERATION MANUAL

Before installation, these instructions must be carefully read and understood.



3. Inspect the seat and disc edge to insure that they were not damaged in handling. This is especially important in the case of valves with 'fail-open' actuators.
4. Confirm that the materials of construction listed on the valve nameplate are appropriate for the service intended and are as specified.
5. Locate the directional arrow on the body that defines the preferred mounting orientation in respect to the pressure. In most cases, the valve is properly installed when the actual fluid flow or high pressure is acting on the front face of the disc when the valve is closed.
6. Ensure that the packing gland nuts and bottom cover bolts are tight.

GENERAL

Suggested installation orientation is with valve shaft horizontal or inclined from vertical. Unless otherwise recommended by Emerson, mount the valve in the preferred direction with the directional arrow pointing to the lower pressure side so that the front face of the disc will be upstream when the valve is in the closed position.

Thermal insulation of the body is mandatory for operating temperatures above 392°F [200°C]. K-LOK offers the following body styles:

Series 36 and 37 – Wafer style
Series 36 and 37 – Lug Style

INSPECTION

1. Carefully remove the valve from the shipping package (box or pallet) to avoid any damage to the valve and, in the case of automated valves, to the electric or pneumatic/hydraulic actuator or instrumentation.
2. Prior to installation, clean the inside of the valve. Insure that there are no solid objects such as pieces of wood, plastic or packing materials within the valve or on the valve seat.

CAUTION

The valve should be installed in the closed position to insure that the seat and disc are not damaged during installation. Particular care should be taken with valves equipped with 'fail open' actuators. Failure to insure proper handling may result in damage to the valve.

If the pipe is lined, confirm that the disc rotation does not contact the lining during the opening stroke. Failure to confirm that the disc rotation does not contact the lining may result in damage to the valve.

IMPORTANT

Whenever possible, install the valve with the shaft in the horizontal position and, if possible, with the cast-in disc stop located top-side of the pipe. If the shaft cannot be positioned horizontally, position the shaft so that it is not on the vertical centerline in a horizontal pipe run. This will minimize any depositing of solid particles present in the fluid into the lower bearing.

KEYSTONE K-LOK® SERIES 36 AND 37 HIGH PERFORMANCE BUTTERFLY VALVE

ISO VERSION INSTALLATION AND OPERATION MANUAL

INSTALLATION

The valves are shipped with flange gasket surface protection. Before installing the valve, remove the protection and carefully clean and de-grease both surfaces with a solvent.

Series 36 and 37 – Wafer style

1. Orient the valve with the directional flow arrow (preferred direction) pointing in the proper direction.
2. Insert the valve between the flanges until the alignment holes at either side of the valve match the corresponding holes in the flanges.
3. Insert a long bolt or stud through the flange and thread it through the alignment hole. This will allow the valve to center itself properly for the installation of the flange gaskets.
4. Install the flange gaskets and the remaining flange bolting.
5. Remove the long bolts/studs from the lower alignment holes and replace with correctly-sized bolts.
6. Using the crossover method, tighten all flange bolts.

Series 36 and 37 – Lug style

1. Orient the valve with the directional flow arrow (preferred direction) pointing in the proper direction.
2. Insert the valve between the flanges until the two bottom holes in the valve align with the two lower flange holes.
3. Insert a bolt or stud through the flange and thread it into the holes in the valve body. This will allow the valve to center itself properly for the installation of the flange gaskets.
4. Install the flange gaskets and the remaining flange bolting.
5. Use the crossover method to tighten all flange bolting.

VALVE CHECKOUT

1. Tighten the packing gland bolting just enough to prevent shaft leakage. Over-tightening will decrease packing life and increase operating torque requirements.
2. Check the operation of the valve by stroking it to 'full open' and 'full close'. To determine the valve orientation of the disc, double D's and keyways are aligned with the disc. The valve disc travels clockwise to close.
3. For automated valves, set the air pressure/ electrical voltage for at least the minimum given to operate the actuator. For pneumatic actuators, do not apply more than 1.25 times the pressure for which the actuator was designed.

Note: for spring return actuators with positioners, overpressure will cause excessive time delay in the spring movement for the valve disc to travel out of the seat.

OPERATION

The K-LOK has been designed to require a minimum of maintenance. Generally, only maintenance on the packing box is required.

MAINTENANCE

If shaft leakage is observed through the packing box, tighten the gland nuts.

Note: do not over-tighten packing box gland nuts. Over-tightening will increase the torque required to operate the valve. When tightening the gland nuts, use half-turn increments until leakage has stopped.

DISASSEMBLY

To begin disassembly, refer to the parts list (Figure 4) and proceed as follows:

WARNING

Depressurize the valve and associated piping before disassembly. Failure to do so may cause serious personal injury and/or equipment damage.

1. Remove the valve from the line. Clean the valve according to proper cleaning procedures as outlined by the plant or according to a prescribed procedure.
2. Remove the actuator and relevant connecting key. Note the actuator position relative to the valve.
3. Removing the Bracket and Adapter
To disassemble adapter and bracket remove the following components
: Bracket (28)
: Adapter (26)
: Washers (29, 31)
: Bolts (30)
: Set screw (32)
: Key (25)
: Nuts (16)

CAUTION

Throughout disassembly and assembly, always use cardboard or brass shims to protect the valve body, disc, flange and sealing surfaces from damage. Failure to do so may result in serious damage to the valve.



Figure 1 - Valve properly clamped in place.

Removing the disc-to-shaft tapered pin connections

1. Open the valve disc (2) to its full open position.

Note: on valve sizes NPS 10 (DN 250) and larger, it is recommended that two workers perform the disc tapered pin (5) removal process.

2. Place the disc in a vise.
3. Using a tool steel punch, locate the punch on the small end of the disc taper pin (5) and then strike the punch with a heavy hammer.

Note: some of the weld on the taper pins (5) may need to be removed by grinding.

WARNING

When placing the valve into the bench vise, make sure the small end of the disc (2) taper pin faces the assembler. (see Figure 1)

Hold the punch with a punch holder or a pair of vise grips. Otherwise, serious injury may occur.

Removing the bottom cover assembly

To disassemble the bottom cover assembly, remove the following bottom cover assembly components:

- bottom cover plate (18)
- bottom cover gasket (17)
- washer (19)
- screw (20)

Removing Bottom cover gasket

Remove the Bottom cover gasket (17). Use pick and hook tool to remove the gasket that may have adhered to gasket groove in bottom cover.

Removing the lower shaft assembly

CAUTION

Throughout this operation, make sure the disc edges remain protected from contact with the body by installing cardboard at all disc hub areas. Failure to do so may cause damage to the disc sealing edge.

1. Spray penetrating oil into the disc hub where it meets the shaft connection.
2. Insert an eyebolt into the lower shaft (4) and use it to pull the lower shaft (4) out of the disc (2). See chart below for proper eyebolt size.

Valve size	Tap
NPS 2 to NPS 6 (DN 50 to 150)	M6 X 1
NPS 8 to NPS 12 (DN 200 to 300)	M10 X 1.5
NPS 14 to NPS 36 (DN 350 to 900)	M14 X 2

3. Lightly strike the backside of the disc hub area with a hammer if the shaft is resistant to removal.

Removing the upper shaft and disc

CAUTION

Throughout this operation, make sure the disc edges remain protected from contact with the body by installing cardboard at all disc hub areas. Failure to do so may cause damage to the disc sealing edge. Protect the shaft from the vise teeth to prevent damage and to eliminate potential for packing leakage.

1. When removing the upper shaft (3) from the disc (2), clamp the vise jaws on to the upper shaft (3) area above the valve body top plate.
2. Once the vise jaws are secure against the upper shaft (3), drive the wedge-shaped chisel/punch between the valve body (1) top plate and the bench vise. (see Figure 2)
3. As the valve body (1) moves away from the bench vise, the upper shaft (3) is removed from the upper disc (2) hub.
4. Continue to reposition the valve body (1) with the bench vise so as to allow removal of upper shaft (3).



Figure 2 - How the upper shaft is removed from the upper disc hub.

CAUTION

Physically hold the disc to prevent the disc from falling and becoming damaged during removal. When both the upper shaft (3) and lower shaft (4) are removed from the disc (2), the disc is unsupported.

WARNING

Smaller discs may be removed by hand (NPS 2 to NPS 8 (DN 50 to DN 200)). Remove larger discs with proper hoisting equipment. Failure to do so may result in personal injury or damage to equipment.

Removing the seat retainer ring

Remove the seat retainer ring (23) by removing hex socket screws (24) from the seat retaining ring for the lugged body or the retainer plate screw (34) from the locating plates (33) and/or clips (35) for the wafer body. (see Figure 3)

Removing the seat retainer gasket

Remove the seat retainer gasket (22). Use a powered wire brush tool to remove the gasket material that may have adhered to the mating body surfaces.

Removing the seat assembly

To remove the seat assembly, treat the seat (21) and its associated components as a single assembly by removing the following:

- seat (21.1)
- wire wrap (21.2)
- seat backing ring (21.3)

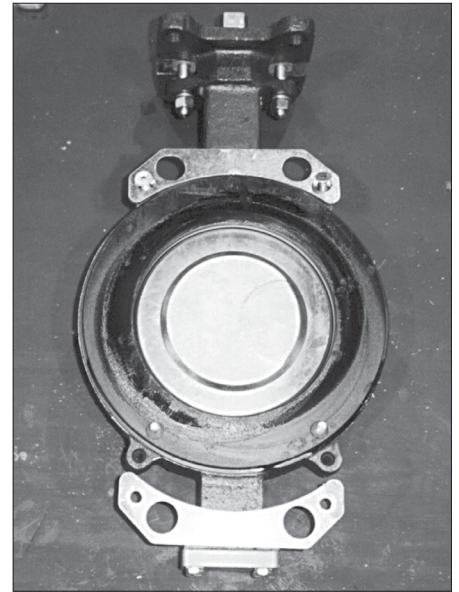

Figure 3 - Seat retainer ring and parts.

Removing the packing assembly

Method 1: for packing replacement with shaft in body

1. Remove the packing gland bolts (14) nuts and Belleville washer (15,16) packing gland bridge (13), packing gland follower (12) and shaft retention ring (11). Using the screws, grab and remove each packing ring, one at a time.

Note: to remove the packing set (10) with the upper shaft (3) still in the valve body (1), two long, slender screws are required. The screws must not have a diameter greater than 1/4" and must be at least six inches long. The most commonly used screws are 'drywall screws'.

KEYSTONE K-LOK® SERIES 36 AND 37 HIGH PERFORMANCE BUTTERFLY VALVE

ISO VERSION INSTALLATION AND OPERATION MANUAL

Figure 4
MATERIALS OF CONSTRUCTION

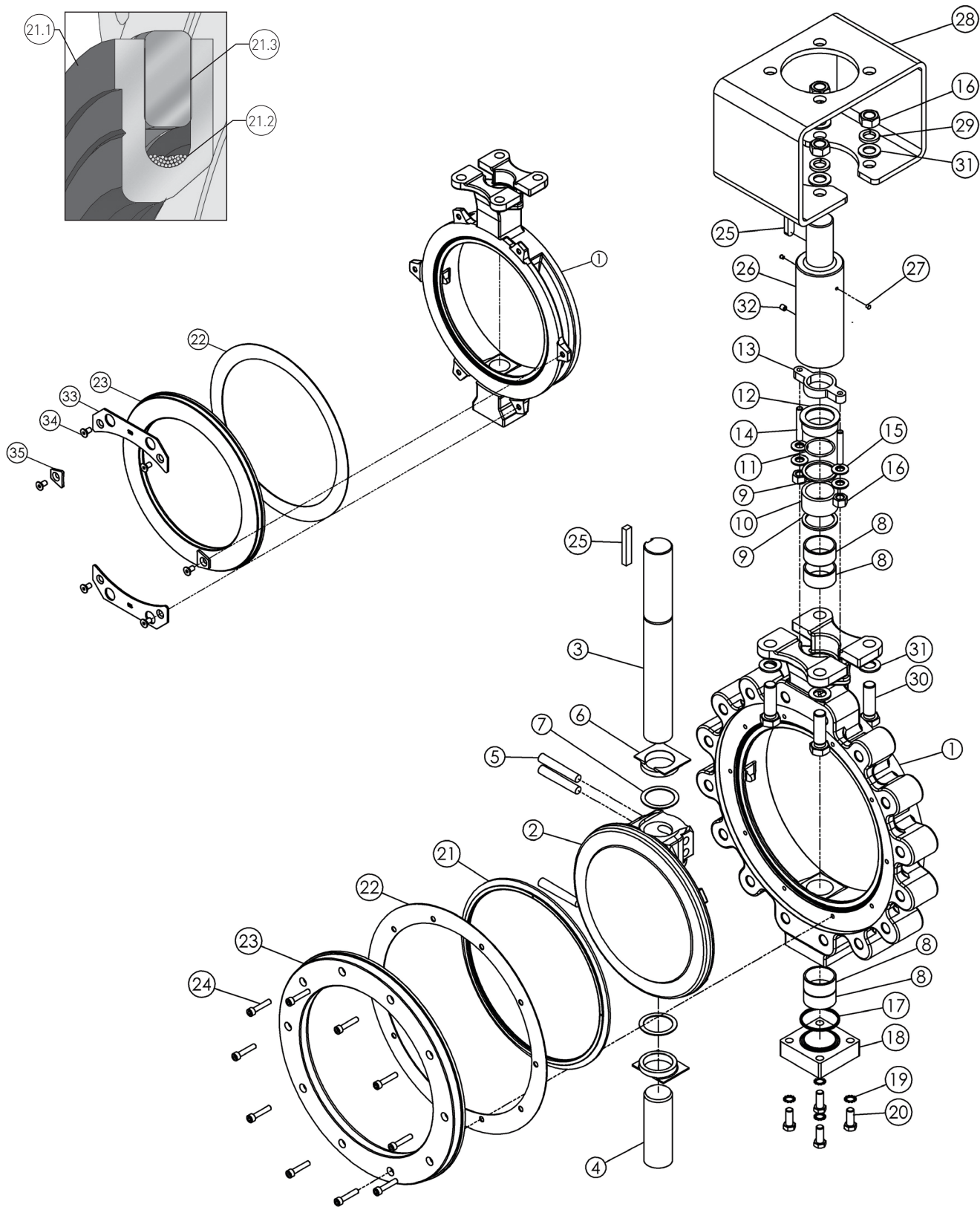

KEYSTONE K-LOK® SERIES 36 AND 37 HIGH PERFORMANCE BUTTERFLY VALVE

ISO VERSION INSTALLATION AND OPERATION MANUAL

STANDARD MATERIALS OF CONSTRUCTION

Sl no.	Part name	Material	Material Standard
1	Body	Carbon Steel	ASTM A216-WCB/ EN 10213 GP240H/ 1.0619
		Stainless Steel	ASTM A351-CF8M/ EN 10213 Gx5CrNiMO 19-11-7/ 1.4408
2	Disc	316 SS	ASTM A351-CF8M/ EN 10213 Gx5CrNiMO 19-11-7/ 1.4408
		316 SS/ENP	ASTM A351-CF8M/ EN 10213 Gx5CrNiMO 19-11-7/ 1.4408/ ENP
3	Upper Stem	17-4PH SS	ASTM A564- Condition H1075 or H1100
4	Lower Stem	17-4PH SS	ASTM A564- Condition H1075 or H1100
5	Taper Pin	17-4PH SS	ASTM A564- Condition H1075 or H1100
6	Spacer	316 SS	
7	Thrust Washer	316SS/BRZ/PTFE	
8	Bearing	316SS/BRZ/PTFE	
		RTFE/Composite	
9	Anti-Extrusion Ring	316 SS	
10	Stem Packing	PTFE	
11	Ring,Stem Retention	316 SS	
12	Gland	316 SS	
13	Gland Bridge	17-4PH SS	
14	Stud	B8 CL2	
15	Belleville Washer	50 CrV4	
16	Hex Nut	Stainless Steel 18.8	
17	Bottom Spiral Wound Gasket	AISI 316+Graphite	
18	Bottom Cover	Carbon Steel	ASTM A516 Gr.70-WCB
		Stainless Steel	ASTM A351-CF8M
19	Washer, ext. Tooth Lock	Stainless Steel 18.8	
20	Screw, Hex HD Cap	B8 CL2	
21	Seat Assembly		
21.1	Seat	Polymer	PTFE , RTFE, UHMWPE
21.2	Wire Sructure	Stainless Steel	
21.3	Seat Backing Ring	Phenolic	
		Stainless Steel	
22	Gasket Seat Retaining Ring	Graphite	
		Non-asbestos fiber	
23	Seat Retaining Ring	Carbon Steel	ASTM A516 Gr.70-WCB
		Stainless Steel	ASTM A351-CF8M
24	Screw, socket hd cap	Stainless steel	
25	Key	Carbon Steel	
26	Coupling (Adaptor)	17-4PH SS	
27	Indicator Pin	Rubber	Black color
28	Bracket	Carbon Steel	Protection level C2 per ISO2081
29	Washer, Split lock	Stainless Steel	
30	Hex Head Bolt	Stainless Steel	
31	Plain Washer	Stainless Steel	
32	Set Screw	Stainless Steel	
33	Retainer Plate	Stainless Steel	
		Carbon Steel/Zinc Plated	
34	Retainer Plate/Clip Screw	Stainless Steel 18.8	
35	Clip	Stainless Steel	
		Carbon Steel/Zinc Plated	

All fasteners are SS (B8M CL2/B8 CL2)

KEYSTONE K-LOK® SERIES 36 AND 37 HIGH PERFORMANCE BUTTERFLY VALVE

ISO VERSION INSTALLATION AND OPERATION MANUAL

Method 2: packing removal with shaft removed from body

1. To remove the packing set (10) with the upper shaft removed, use a hook-type tool to pull out one packing ring at a time.

Removing the shaft bearing

Note: a special bearing removal/installation tool is required to remove or install the shaft bearing (8). The tool O.D. dimension should be as near in size as the valve shaft bore I.D. dimension and have a Class 3 fit. Any Machinist Handbook can provide Class 3 tolerances.

1. Insert the removal tool in the valve body (1) top plate area and down the upper shaft journal until the tool contacts the upper shaft bearing.
2. Remove the upper shaft bearing (8) by striking the tool with a hammer.
3. Insert the removal tool in the valve body (1) bottom plate area and down the lower shaft journal until the tool contacts the lower shaft bearing.
4. Strike the tool until the lower shaft bearing (8) is clear of the lower body shaft journal.

Inspecting the valve components

1. After disassembly, visually inspect the seat retainer ring (23) and the bottom cover plate (18).
2. Make sure all body sealing surfaces:
 - are flat
 - are free of corrosion damage
 - have a smooth surface
 - are free of burrs.

Remove any burrs with fine grit sandpaper.

3. Inspect for scratches around disc edges:
 - If scratched, smooth the edge with fine grit sandpaper (220/400 wet/dry sandpaper)
 - Remove the scratch by using a blending motion and extend the smoothed area at least two inches above, below and around the original scratch
 - To polish the disc edge, use a powered wire brush
 - Finish sand or polish the edge on a lathe, as required.
4. Check to see that the upper and lower (3, 4) shaft-to-bearing (8) contact locations are free of galling.
5. Check to see that the upper (3) shaft-to-packing (23) contact area is free of scratches.

Note: if scratched or galled, these surfaces should be polished or replaced.

ASSEMBLY

Installing shaft bearing

1. Insert the body into a vice as shown below. Protect the body flange surfaces from the vise clamping surfaces with cardboard or brass shims.
2. To avoid damaging the shaft bearing (8), gently press the bearing into the shaft body journal by lightly striking the bearing (8) with a rubber mallet.
3. Once the shaft bearing (8) has been partially inserted into the valve body journal, insert the installation/removal tool against the upper shaft bearing. (see Figure 5)
4. Strike the tool with a hammer to continue inserting the shaft bearing until it is flush with the body flowpath surface. (see Figure 6)

Installing the disc/shaft assembly

CAUTION

To prevent damage to the disc, do not allow the disc edges to contact the body flowpath surface.

1. Install the upper shaft (3) and lower shaft (4) into the valve body shaft journals with the pinning grooves position on top of the shaft side view.

Note: the upper and lower shafts are correctly installed when the lower ends of the shafts are flush with the body flowpath surface.

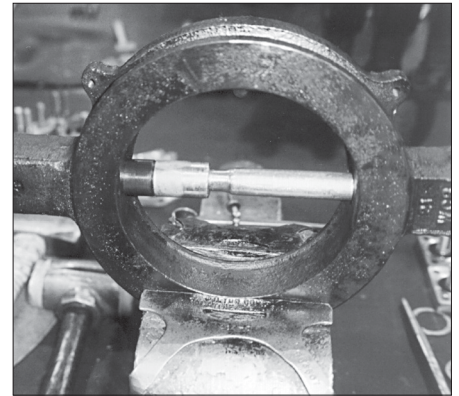

Figure 5 - Partial insertion of the shaft bearing.

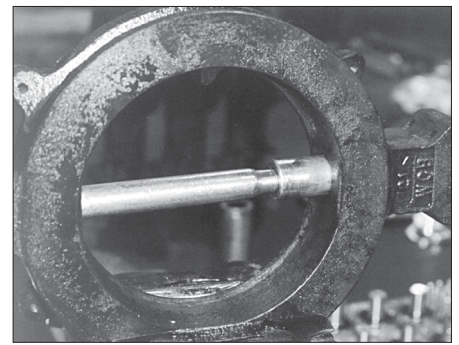

Figure 6 - Shaft bearing flush with the flow path surface.

KEYSTONE K-LOK® SERIES 36 AND 37 HIGH PERFORMANCE BUTTERFLY VALVE

ISO VERSION INSTALLATION AND OPERATION MANUAL

- Insert the disc locating spacers (6) and thrust washers into the grooves on either side of the disc (2). Align the spacer flat surface with the body flat surface on the shaft journals.
- While holding the disc (2) with the backside of the disc facing up and the double pin hub facing toward the body (1) upper shaft journal, position the disc (2) in the body (1).
- Push the shafts (3 and 4) through the spacers (6) and into the disc (2) hub shaft holes.
- If required, rotate the shafts until the shaft tapered pin holes are in alignment with the disc (2) hub tapered pin holes.
- Manually push the disc tapered pins (5) to install them through the disc hub tapered pin holes.
- Install the packing set (see Installing the packing set).
- Carefully drive the tapered pins (5) firmly into the connection with a punch and hammer.

- Tighten the four bolts and washers (19, 20). (as below)
- There should be a uniform gap between bottom cover and body.

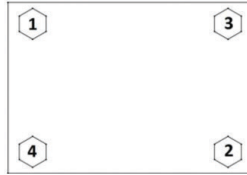

Table 1: Bottom Cover Gasket Screw Torques

Metric bolt size	Class 150/300			
	in-lb	ft-lb	N-m	N-cm
M6	62.4	5.2	7	700
M8	159.6	13.3	18	1800
M10	266.4	22.2	30	3000

Installing the standard seat assembly

- Check to make sure the disc (2) is in the closed position against the body (1) disc stop.
- Install the seat with the smallest inside diameter down. If the seat is incorrectly installed, it will ride higher on the disc than if installed correctly.

Installing the packing set

- Install the anti-extrusion packing ring (9), packing set (10), second anti-extrusion ring (9), shaft retention ring (11), bellville washers (15) and packing gland (12) into the upper journal of the valve body (1). (See Figure 8)
- Keeping the disc assembly (2 - 7) in the closed position, tighten the packing nuts (16). Nuts have been correctly tightened when the packing gland plate (13) is flush with the valve body (1) top plate. Refer to the below table for bolt torque.

Belleilve Washer

Size	Qty
NPS 2 - NPS 12 [DN 50 to DN 300]	8

Torque for Gland Bolts

Class 150/300		
Valve (in)	Stud	Torque (Nm)
2	M8 x 1.25	23
2.5	M8 x 1.25	23
3	M8 x 1.25	24
4	M8 x 1.25	28
5	M8 x 1.25	28
6	M10 x 1.5	39
8	M10 x 1.5	48
10	M10 x 1.5	57
12	M10 x 1.5	61

Installing the bottom cover assembly

- Place the bottom cover gasket (17) on the bottom cover plate (18) gasket groove.
- Align the bottom cover plate (18) with the body (1) bottom surface, making sure the bottom cover gasket (17) remains in alignment with the bottom cover plate (18) gasket groove.

Installing the seat retainer ring

- Check to make sure the disc (2) is in the closed position against the body (1) disc stop.
- Put the seat retainer gasket (22) on the valve body (1) gasket surface. (see Figure 7)
- For lug style bodies, align the seat retainer ring gasket (22) holes with the holes in the body (see Figure 7).
- Place the seat retainer ring (23) on top of the seat retainer gasket (22). For lug style valves, align the holes in the seat retainer ring (23) with the holes in the gasket (22) and the body (1).
- Place the locating plates (33) and/or clips (35) for wafer style valve body.
- Install and tighten the screws (34) for wafer valve and (24) for lug valve.

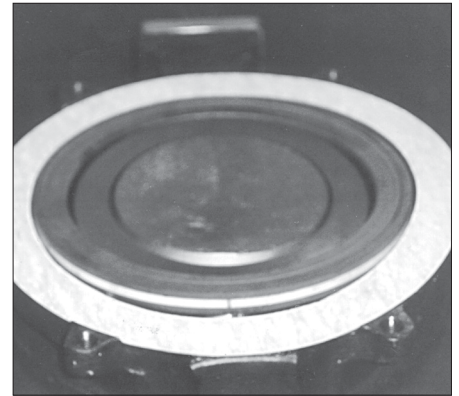

Figure 7 - Proper placement of seat retainer gasket.

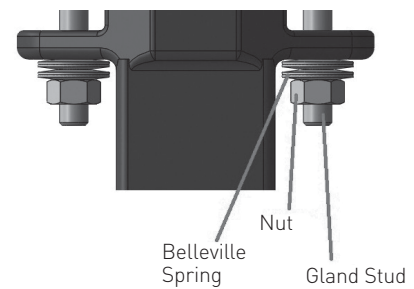

Figure 8 - Installing the Packing Set

KEYSTONE K-LOK® SERIES 36 AND 37 HIGH PERFORMANCE BUTTERFLY VALVE

ISO VERSION INSTALLATION AND OPERATION MANUAL

CAUTION

The standard seat retainer screws provide only enough force to hold the seat retainer ring (23) for shipment and installation. If valve actuation is required before installation, press the seat retainer into the seat to prevent damage to the valve seat before actuation.

7. Press the seat retainer ring into the seat (21) and body (1) using two C-clamps to provide the needed compressive load. To press the seat retainer ring with the C-clamps, place the C-clamps on the valve assembly to allow an even load to be applied all around the seat retainer ring (23) and tighten until the seat retainer gasket (22) is compressed.
8. With the C-clamps pressing the seat retainer ring (23) into the gasket (22). Tighten the screws (34).

CAUTION

To prevent damage to the valve when clamping, protect the body flange surfaces from the vise clamping surfaces with cardboard or brass shims.

TIG welding of the disc taper pins

1. After assembling and testing the valve, lock the three disc/shaft taper pins (5) by forcefully driving the tapered pins in place with a hammer and steel punch.
2. TIG weld the disc taper pins (5). Weld using filler rod referenced in Table 1.

TABLE 1

Shaft and pin material	Filler rod
17-4 PH 1075 HT	312 Stainless steel

Symptom	Possible cause	Resolution
Valve won't rotate	<ol style="list-style-type: none"> 1. Actuator has failed 2. Valve packed with debris 3. Shaft key has sheared 	<ol style="list-style-type: none"> 1. Repair or replace 2. Flush or clean valve to remove debris 3. Determine cause of shearing and correct, replace
Shaft packing leaking	<ol style="list-style-type: none"> 1. Gland flange bolting loose 2. Packing damaged 	<ol style="list-style-type: none"> 1. Tighten gland flange bolting 2. Depressurize valve and replace packing
Bottom cover gasket leaking	<ol style="list-style-type: none"> 1. Bottom cover bolting loose 2. Gasket damage 	<ol style="list-style-type: none"> 1. Tighten bottom cover bolting 2. Remove valve from service and replace gasket
Valve leaking	<ol style="list-style-type: none"> 1. Valve not fully closed 2. Debris trapped in valve 3. Seat or disc edge damaged 4. Actuator mechanical closure stop incorrect 	<ol style="list-style-type: none"> 1. Close valve 2. Cycle and flush to remove debris 3. Remove valve from service and replace seat and/or repair or replace disc 4. Adjust the stop to allow further closure
Jerky operation	<ol style="list-style-type: none"> 1. Shaft/bearing damaged 2. Actuator/shaft adapter misaligned 3. Overtightened packing 4. Air supply inadequate 	<ol style="list-style-type: none"> 1. Disassemble valve and inspect for damage, repair or replace damaged parts, reassemble 2. Remove actuator mounting and realign 3. Loosen packing to hand tight, cycle valve, retighten 4. Increase air supply pressure

Neither Emerson, Emerson Automation Solutions, nor any of their affiliated entities assumes responsibility for the selection, use or maintenance of any product. Responsibility for proper selection, use, and maintenance of any product remains solely with the purchaser and end user.

Keystone is a mark owned by one of the companies in the Emerson Automation Solutions business unit of Emerson Electric Co. Emerson Automation Solutions, Emerson and the Emerson logo are trademarks and service marks of Emerson Electric Co. All other marks are the property of their respective owners.

The contents of this publication are presented for informational purposes only, and while every effort has been made to ensure their accuracy, they are not to be construed as warranties or guarantees, express or implied, regarding the products or services described herein or their use or applicability. All sales are governed by our terms and conditions, which are available upon request. We reserve the right to modify or improve the designs or specifications of such products at any time without notice.