

AMS 9420 Wireless Vibration Transmitter

Reference Manual



Copyright

© 2020 by Emerson. All rights reserved.

No part of this publication may be reproduced, transmitted, transcribed, stored in a retrieval system, or translated into any language in any form by any means without the written permission of Emerson.

Disclaimer

This manual is provided for informational purposes. EMERSON MAKES NO WARRANTY OF ANY KIND WITH REGARD TO THIS MATERIAL, INCLUDING, BUT NOT LIMITED TO, THE IMPLIED WARRANTIES OF MERCHANTABILITY AND FITNESS FOR A PARTICULAR PURPOSE. Emerson shall not be liable for errors, omissions, or inconsistencies that may be contained herein or for incidental or consequential damages in connection with the furnishing, performance, or use of this material. Information in this document is subject to change without notice and does not represent a commitment on the part of Emerson. The information in this manual is not all-inclusive and cannot cover all unique situations.

Patents

The product(s) described in this manual are covered under existing and pending patents.

Where to get help

Software Registration

Phone: Toll free 888.367.3774, option 2 (U.S. and Canada)
+63.2.702.1111 (Rest of world)

Email: wwcs.custserv@emerson.com

Web: <http://www.emerson.com/machineryhealthreg>

Product Support

Emerson provides a variety of ways to reach your Product Support team to get the answers you need when you need them:

Phone Toll free 800.833.8314 (U.S. and Canada)
+1.512.832.3774 (Latin America)
+63.2 702.1111 (Asia Pacific, Europe, and Middle East)

Email ap-sms@emerson.com

Web <http://www.emerson.com/en-us/contact-us>

To search for documentation, visit <http://www.emerson.com>.

To view toll free numbers for specific countries, visit <http://www.emerson.com/technicalsupport>.

Contents

Chapter 1	Introduction.....	6
	1.1 Safety messages.....	6
	1.2 Overview.....	7
	1.3 Considerations.....	11
	1.4 Return of materials.....	12
Chapter 2	Install the AMS 9420.....	14
	2.1 Sensors.....	14
	2.1.1 Sensor operating limits.....	14
	2.1.2 Sensor handling.....	15
	2.1.3 Sensor mounting/attachment tools and supplies.....	16
	2.1.4 Prepare the sensor mount.....	17
	2.1.5 Attach the sensors.....	18
	2.1.6 Secure the sensor cables.....	22
	2.1.7 Conduit installation guidelines.....	23
	2.1.8 Cable entry port installation guidelines.....	24
	2.1.9 Attach sensor wiring to the AMS 9420 terminals.....	27
	2.2 Power the AMS 9420 with a power module.....	30
	2.2.1 Power module installation and replacement.....	30
	2.2.2 Physical installation.....	32
	2.3 Power the AMS 9420 with external DC power.....	33
	2.3.1 Emerson A9000P description of intended use.....	33
	2.3.2 Optional spacer.....	33
	2.3.3 Connect external DC power to Emerson wireless transmitters.....	34
	2.3.4 Connect external DC power and ICP [®] accelerometer inputs to an AMS 9420.....	36
	2.4 Install the end cap.....	39
	2.5 Position the antenna.....	40
	2.6 Liquid Crystal Display (LCD).....	42
	2.6.1 Rotate the LCD.....	42
	2.6.2 Enable the LCD.....	43
	2.6.3 Turn on the LCD.....	44
	2.7 Ground the transmitter.....	45
Chapter 3	Configure the AMS 9420.....	46
	3.1 Configuration overview.....	46
	3.1.1 Connect to a wired HART interface.....	48
	3.1.2 Set the wireless network configuration.....	50
	3.1.3 Configuration options.....	52
	3.1.4 Sensor configuration.....	53

3.1.5	Measurement parameter units.....	55
3.1.6	Alert levels.....	55
3.1.7	Publishing mode.....	57
3.1.8	Update rate.....	58
3.1.9	Minimize power consumption.....	58
3.1.10	Trend parameters.....	59
3.1.11	Remove the power module.....	60
3.2	Configuration with a Field Communicator.....	60
3.2.1	Field Communicator menu trees.....	61
3.2.2	Field Communicator fast key sequences.....	74
3.3	Configuration with AMS Device Manager.....	76
3.3.1	Configure wireless network credentials in AMS Device Manager.....	76
3.3.2	Right-click menu.....	77
3.4	Configuration with AMS Machinery Manager.....	101
3.4.1	Advanced Diagnostics application.....	101
3.4.2	AMS 9420 Data Collection: Overview.....	105
3.4.3	AMS 9420 publishing policy.....	106
3.4.4	Maximum network size and publishing policy settings.....	108
3.4.5	Waveform or spectrum time.....	111
Chapter 4	Operation.....	112
4.1	Verify the device is operational.....	112
4.2	Verify operation with the integral LCD.....	112
4.3	Verify operation with a 475 Field Communicator.....	112
4.4	Verify operation with Emerson Wireless Gateway.....	113
Chapter 5	Overall Velocity, PeakVue, and temperature.....	115
5.1	Overall Velocity.....	115
5.2	PeakVue.....	118
5.3	Temperature.....	122
5.3.1	Relative temperature monitoring.....	123
5.3.2	Absolute temperature monitoring.....	123
Chapter 6	Mitigating EMI and RFI.....	125
6.1	Accelerometer EMI and RFI considerations.....	125
6.2	Mitigate interference.....	127
6.2.1	Use shorter cable lengths.....	127
6.2.2	Use a conductive conduit.....	127
6.2.3	Install ferrites.....	129
6.2.4	Reduce polarized interference.....	136
Appendix A	Specifications and reference data.....	138
A.1	Functional specifications.....	138
A.2	Physical specifications.....	140

A.3 Performance specifications.....	141
A.4 Radio specifications.....	141
A.5 Low-power sensor options.....	142
A.6 Dimensional drawings.....	143
A.7 Device variable index.....	144
Appendix B Product certifications.....	145
B.1 Approved manufacturing locations.....	145
B.2 Wireless certifications.....	145
B.3 Ordinary location certification (CSA).....	146
B.4 CE mark.....	146
B.5 Hazardous locations certifications.....	147
B.6 RoHS 2 (2011/65/EU).....	148
Appendix C LCD screen messages.....	149
Index	157

1 Introduction

Topics:

- [1.1 Safety messages](#)
- [1.2 Overview](#)
- [1.3 Considerations](#)
- [1.4 Return of materials](#)

1.1 Safety messages

Instructions in this manual may require special precautions to ensure the safety of the personnel performing the operations.

This AMS 9420 device complies with Part 15 of the FCC Rules. Operation is subject to the following conditions: This device may not cause harmful interference, this device must accept any interference received, including interference that may cause undesired operation.

This device must be installed to ensure a minimum antenna separation of 20 cm from all persons.

Refer to the following safety messages before performing an operation preceded by the warning symbol:

WARNING

Failure to follow these installation guidelines can result in death or serious injury. Only qualified personnel should install AMS 9420s.

Explosions could result in death or serious injury:

- Before connecting a Field Communicator in an explosive environment, make sure the instruments are installed in accordance with applicable field wiring practices.
- Verify that the operating environment of the AMS 9420 is consistent with the appropriate hazardous locations certifications.
- Do not remove the front electronics end cap or LCD cover while the device is in a hazardous area.

Electrical shock can cause death or serious injury. Avoid contact with the leads and terminals. High voltage that may be present on leads can cause electrical shock.

1.2 Overview

The manual

This Reference Manual applies to the 2.4 GHz WirelessHART version of the AMS 9420 for use with the Smart Power Module unless otherwise specified.

Use this manual to install, operate, and maintain the AMS 9420 Wireless Vibration Transmitter.

The transmitter

The AMS 9420 Wireless Vibration Transmitter is an installation-ready solution that monitors vibration and temperature in hard-to-reach locations. It also provides a variety of transmitter and sensor configurations.

Some of its features include:

- Support for up to 4 process variables with up to 3 user configurable alerts for each process variable
- Support for storage of Waveform/Spectrum directly in AMS Machinery Manager
- Wireless output with >99% data reliability, delivering rich HART data, protected by industry leading security (when operated as part of a well-formed network)
- Local operator interface with integral LCD that conveniently displays measured values and diagnostics
- Simple and easy installation, used today for robust installations

Power options include two power modules and power adapter for external DC power.

The transmitter's main parts are shown in [Figure 1-1](#) and are referenced in this document.

Figure 1-1: AMS 9420 overview

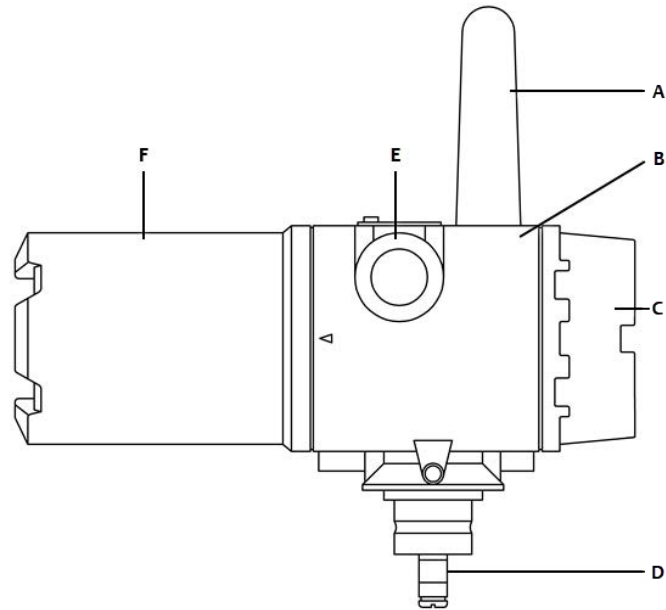

- A. Antenna
- B. Housing
- C. Front electronics end cap or LCD cover
- D. Mounting post
- E. Cable entry port (one on left and right)
- F. Extended end cap or power module cover

Related documentation

Refer to the following related documents which are included with the products they describe.

Table 1-1: Referenced documents for AMS 9420 power options

MHM-97913-CC-PBF	Quick Start Guide: Emerson™ SmartPower™ - Blue Power Module 701PBU
00925-0100-4701	Quick Start Guide: Emerson™ SmartPower™ - Black Power Module 701PBK
MHM-97919-PBF	Quick Start Guide: Emerson™ A9000Px Power Adapter

Device revision information

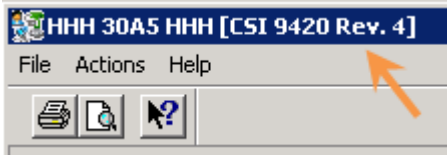
Revision	Current level	Description
Universal	7	This is the HART version the transmitter supports.
Field device ¹	4	This is the major revision of the transmitter and corresponds with a major interface release. When using AMS Device Manager, this revision can be found on the screen title. 
Software	8	This is the current software version. The software may be occasionally modified to refine functionality. When major functionality is added, the device revision increases.
Hardware	5	This is the hardware revision.
DD	1	This is the Device Descriptor (DD) revision. The device descriptor is primarily used for configuring devices in the field.

¹ If you have an older device revision, a factory upgrade may be possible in some cases. Contact Product Support for more information.

You can view the revision information in a Field Communicator and in AMS Device Manager.

Figure 1-2: Revision numbers in a 475 Field Communicator

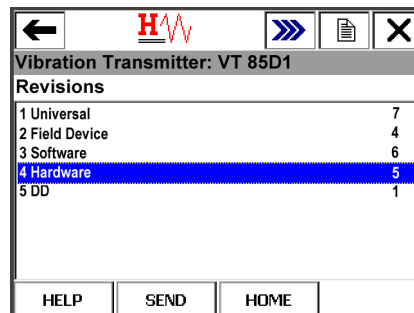
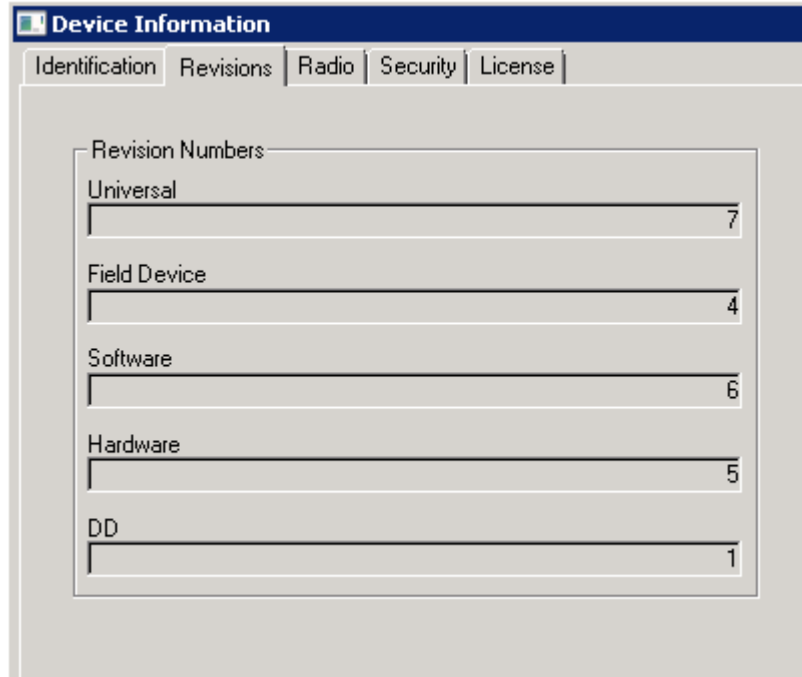

Figure 1-3: Revision numbers in AMS Device Manager



1.3 Considerations

General

Electrical vibration sensors, such as accelerometers, produce low-level signals proportional to their sensed vibration. With simple HART configuration, the transmitter converts the low-level sensor signal to a wireless-enabled signal.

Commissioning

The transmitter can be commissioned before or after installation. You can commission it on the bench before installation to ensure proper operation and to be familiar with its functions.

Make sure the instruments are installed in accordance with applicable field wiring practices.

The AMS 9420 device is powered whenever the power module is installed. To avoid depleting the power module, remove it when the device is not in use.

Installation

When choosing an installation location and position, provide ample access to the transmitter. For best performance, the antenna should be vertical, with some space between objects in a parallel metal plane such as a pipe or metal framework. Pipes or framework may adversely affect the performance of the antenna.

Power Module

There are two power modules that may be used with the AMS 9420.

Where approved for use, Emerson recommends using the blue power module. The blue power module is equipped with two "D" size primary lithium/thionyl chloride cells, and features special power management circuitry for optimum performance with the AMS 9420. Each blue power module contains approximately 10 grams of lithium. The black power module contains two "C" size primary lithium/thionyl chloride batteries. The black power module contains approximately 5 grams of lithium; therefore, the blue power module will operate the AMS 9420 for approximately twice as long as the black power module.

Note

When upgrading from the black power module to the blue power module, be sure to order an extended battery cover for each blue power module. To order an extended battery cover for the blue aluminum housing or the stainless steel housing, contact your local sales representative.

Under normal conditions, power module materials are self-contained and not reactive as long as the integrity of the batteries and power module pack are maintained. Take care to prevent thermal, electrical, or mechanical damage, and protect contacts to prevent premature discharge.

⚠ CAUTION

Use caution when handling power modules. Power modules may be damaged if dropped from heights in excess of 20 feet.

Electrical

Emerson A9000Px series adapters	<p>A power adapter is available to connect the AMS 9420 to an external 11-28 VDC power source. This is used in place of the power module.</p> <p>When used with a barrier on the power input, the AMS 9420 has the same ratings for hazardous location requirements.</p> <p>Power in and external sensors must be wired via separate entries.</p> <p>An external earth connection, where applicable, should be made to the earth grounding point on the bottom of the housing.</p> <p>The full assembly shall maintain a minimum IP rating of IP20.</p> <p>Field wiring using multiconductor cable shall either have each conductor enclosed in grounded metal shield or each conductor have a minimum of 0.25 mm (0.01 in) insulation thickness.</p>
Sensor	<p>Make sensor connections through the cable entry at the side of the connection head. Provide adequate clearance for cover removal.</p>

Environmental

The transmitter operates within specifications for ambient temperatures between -40°F and 185°F (-40°C and 85°C).

Verify that the operating environment of the transmitter is consistent with the appropriate hazardous location certifications.

1.4 Return of materials

You may need to ship the device to an Emerson Product Service Center for return or maintenance. Before shipping, contact Emerson Product Support to obtain a Return Materials Authorization (RMA) number and receive additional instructions.

Emerson Product Support contact information:

Phone	Toll free 800.833.8314 (U.S. and Canada) +1.512.832.3774 (Latin America) +63.2 702.1111 (Asia Pacific, Europe, and Middle East)
Email	ap-sms@emerson.com
Web	http://www.emerson.com/en-us/contact-us

Note

If the transmitter has been exposed to hazardous substances, a Material Safety Data Sheet (MSDS) must be included with the returned materials. An MSDS is required by law to be available to people exposed to specific hazardous substances.

Shipping considerations for wireless products (Lithium Batteries)

- The unit was shipped to you without the power module installed. Please remove the power module prior to shipping the unit.
- Each blue power module contains two "D" size primary lithium-thionyl chloride battery cells; each black power module contains two "C" size primary lithium-thionyl chloride battery cells. Primary lithium batteries are regulated in transportation by the U.S.

Department of Transportation, and are also covered by IATA (International Air Transport Association), ICAO (International Civil Aviation Organization), and ADR (European Ground Transportation of Dangerous Goods).

- It is the responsibility of the shipper to ensure compliance with these or any other local requirements. Please consult current regulations and requirements before shipping.

2 Install the AMS 9420

Topics:

- [2.1 Sensors](#)
- [2.2 Power the AMS 9420 with a power module](#)
- [2.3 Power the AMS 9420 with external DC power](#)
- [2.4 Install the end cap](#)
- [2.5 Position the antenna](#)
- [2.6 Liquid Crystal Display \(LCD\)](#)
- [2.7 Ground the transmitter](#)

Before beginning installation procedures:

Insert the power module only when you are ready to commission the device.

Install the Emerson Wireless Gateway and ensure it functions properly before you activate the AMS 9420 or any other wireless devices. Power up wireless devices in order of proximity from the Emerson Wireless Gateway, beginning with the closest. This will result in a simpler and faster network installation.

⚠ WARNING

If the sensor is installed in a high-voltage environment and a fault condition or installation error occurs, the sensor leads and transmitter terminals could carry lethal voltages. Use extreme caution when making contact with the leads and terminals.

2.1 Sensors

Each of the AMS 9420 signal inputs uses accelerometers to make vibration measurements. The term "sensor" applies to both an accelerometer and an accelerometer with embedded temperature; the word "accelerometer" refers to a sensor that measures only acceleration. The AMS 9420 uses special low-power sensors (available for purchase from Emerson) to reduce power consumption and increase power module life. The sensor is available with or without embedded temperature.

You can use 100 mV/g sensors with the AMS 9420 if you connect the sensors and external DC power to the Emerson A9000PS-A power adapter.

2.1.1 Sensor operating limits

Low-power sensors with 25 mV/g nominal sensitivity are required when connecting directly to the AMS 9420 terminals. The Emerson A9000PS-A adapter is required for ICP[®] accelerometers with a nominal sensitivity of 100 mV/g.

Table 2-1: Standard, low-power sensor operational ranges

Channel	DC bias range	DC input range	AC input range
Accelerometer 1	2–3 VDC	0–5 VDC	0.5–4.5 V (+/-80 g's peak)

Table 2-1: Standard, low-power sensor operational ranges (continued)

Channel	DC bias range	DC input range	AC input range
Accelerometer 2	2–3 VDC	0–5 VDC	0.5–4.5 V (+/-80 g's peak)
Temperature 1	N/A	-40°C to 125°C	N/A

The accelerometers require a DC bias. The AMS 9420 provides the necessary bias and measures it to verify correct sensor operation. The nominal bias voltage is 2.5 V. If the bias voltage is outside of the 2–3 V range, the device generates a failed alert for the associated sensor. The DC input range represents the operational DC range of the signal input. The AC input range represents the operational AC range of the signal input.

2.1.2 Sensor handling

Note

Each sensor requires a standard 1/4–28-inch mounting location.

⚠ CAUTION

Do not drop, hammer, or impact the sensor housing before, during, or after installation.

⚠ CAUTION

Do not exceed the specified torque when tightening a stud-mounted sensor. Over-tightening a sensor will damage the sensing element and void the manufacturer's warranty.

⚠ CAUTION

Although the integral cable has a built-in strain relief, do not use excessive force when pulling the cable. Do not exert more than 5-lb of force directly on the sensor connection during installation. If possible, secure the cable to the machine near the point of sensor installation.

⚠ CAUTION

Do not exert more than 5-lb pull force directly on sensor/cable connection during wire pulls.

For sensors that have been mounted before pulling the cable through the conduit or raceway to the AMS 9420, leave the cable bundled and secured to the machine. Permanent signal degradation takes place when cables are damaged. Do not step on, kink, twist, or pinch cables. Also take note of the placement of the cable bundle. Do not place bundles in a manner that may cause strain at the sensor/cable connection.

⚠ WARNING

If the sensor is installed in a high-voltage environment and a fault condition or installation error occurs, the sensor leads and transmitter terminals could carry lethal voltages. Use extreme caution when making contact with the leads and terminals.

For high-voltage environments, attach the sensor leads first before connecting to a power source.

Tip

Use Spade lugs to improve long-term reliability of sensor wiring.

2.1.3 Sensor mounting/attachment tools and supplies

Mounting tools

- Drill
- Spot face or end mill tool

The spot face tool attaches to a standard electric drill and provides a machined surface that is at least 1.1 times greater than the diameter of the sensor. The spot face tool also drills a pilot hole that can then be tapped for a stud mounted sensor.

You can purchase the spot face tool from Emerson (MHM P/N 88101), or you can substitute a spot face tool with similar characteristics as required. Contact your local sales representative for assistance.

Figure 2-1: Spot face or end mill tool



Attachment tools and supplies

- 40-200 inch-lb torque wrench with 1/8 in. hex bit
Suggested vendor: Grainger (P/N 4YA74)
Description: 3/8" drive inch-lb torque wrench. You can substitute with any torque wrench with a range of 40 to 70 inch-lb and less than 5 inch-lb increments.
- 1/4-28" taps and tap handle
- 9/16" open-end wrench
- 1/8" hex Allen key
- Wire brush

- Plant-approved cleaner/degreaser
- Plant-approved semi-permanent thread locker (e.g. Loctite)

For epoxy mount, you also need the following:

- 2-part epoxy (e.g. Loctite Depend [Emerson P/N A92106] or comparable)
- A212 Mounting Pads

Figure 2-2: A212 mounting pad



-
- (Optional) Grinder – to create a sufficiently flat mounting surface

2.1.4 Prepare the sensor mount

Stud mount (preferred)

Stud mount provides increased reliability, improved frequency response, and increased signal sensitivity.

Prerequisites

The mounting location must provide a flat surface of at least 0.5 in. (12.7 mm) in diameter and a case thickness exceeding 0.4 in. (10.2 mm). If this is not possible, use the epoxy mount method instead

Procedure

1. Prepare the spot face or end mill tool by setting the drill bit depth to a minimum of 0.325 in. (8.255 mm).
2. Using a wire brush and plant-approved cleaner, clean and degrease the surface area.
3. Keeping the spot face and end mill tool perpendicular to the machine surface, drill into the mounting location until the surface is smooth to the touch with no noticeable irregularities. This may require the spot face tool to remove as much as 0.04 in. (1.016 mm) or more from the surface.

Note

If the spot face is not uniform on all sides, it indicates that the spot face tool is not perpendicular to the mounting surface, and the resulting surface will not allow the sensor to be mounted properly. See [Sensor mounting diagrams](#) for illustrations of the correct milling process.

4. Using 1/4-28 in. tap set, tap a pilot hole to a minimum depth of 0.25 in. (6.35 mm). See [Sensor mounting diagrams](#) for an illustration of tapping a pilot hole.

Epoxy mount (alternative)

If it is not practical to drill into the machine casing, then the epoxy mount method is acceptable.

Procedure

1. If the equipment surface has a radius of curvature that is less than 4 in. (100 mm), grind a flat surface approximately 0.5 in. (12.7 mm) in diameter.
2. Using a wire brush and plant-approved cleaner, clean and degrease the surface area.
3. Using a 2-part epoxy (such as Emerson P/N A92106), spray the activator onto the mounting surface. Place a light coat of epoxy on the surface of the mounting pad and hold firmly against the machine spot face surface for 1 minute.

Note

If the adhesive does not set within 1 minute, it indicates that too much epoxy is applied or that the mounting surface is not prepared properly. Repeat steps 2–3.

2.1.5 Attach the sensors

Figure 2-3 shows a typical accelerometer, mounting stud, and mounting pad used with the AMS 9420. The mounting pad is only necessary when doing an epoxy mount.

Figure 2-3: Accelerometer, mounting stud, and optional mounting pad



- A. *accelerometer*
- B. *mounting stud (included with the accelerometer)*
- C. *mounting pad*

Prerequisites

Whenever possible, mount sensors to the machine while pulling cables. If you have to mount the sensor at another time, secure the bundled cable to the machine and protect it from damage.

Procedure

1. Using a plant-approved cleaner/degreaser, remove any lubricating fluid used during the tapping process and if necessary, clean the mounting stud threads.
2. Rub a small amount of semi-permanent thread locker onto the mounting location.

Figure 2-4: Apply thread locker onto mounting location

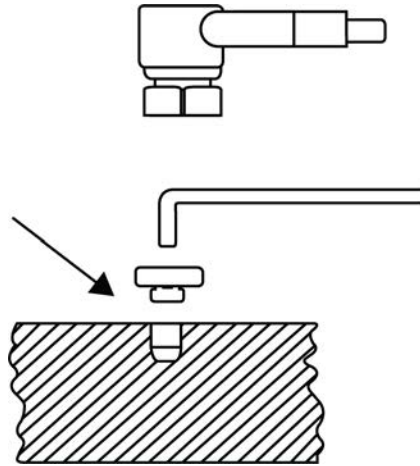

3. Using a 1/8 in. Allen key (English mounting stud) or a 4 mm Hex Allen key (metric mounting stud), loosely screw the mounting stud into the mounting location.
The mounting location is the machine surface when using stud mount and the mounting pad when using epoxy mount.
4. Using a torque wrench with 1/8 in. hex bit, torque to 7–8 ft-lb (9.5–10.8 N-m) to tighten the mounting stud.

Figure 2-5: Tighten the mounting stud

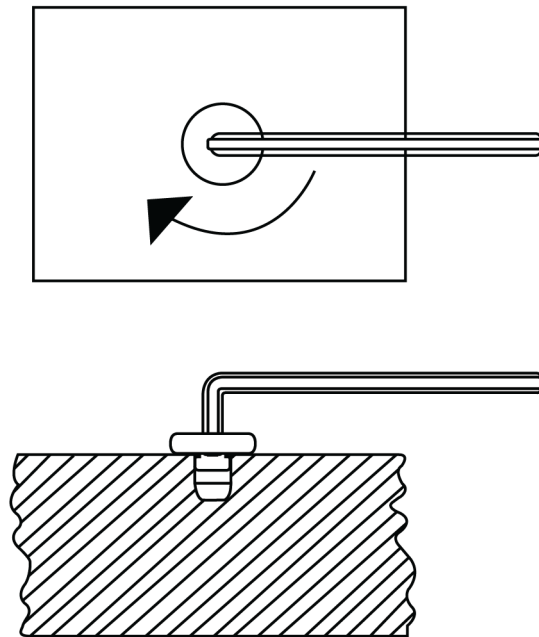

For stud mount: If the mounting stud is still not seated against the spot face after you apply the correct torque force, it indicates that the tap hole is not deep enough. Remove the mounting and tap a deeper hole.

5. Apply a thin coat of semi-permanent thread locker to the threads on the sensor housing.
6. Place the sensor onto the mounting stud and hold it to create the least amount of cable strain and cable exposure. While holding the sensor, hand-tighten the 9/16 in. captive nut and use a torque wrench with 9/16 in. open end to finish tightening to 2–5 ft-lb (2.7–6.8 N-m).

Figure 2-6: Hand-tighten the captive nut

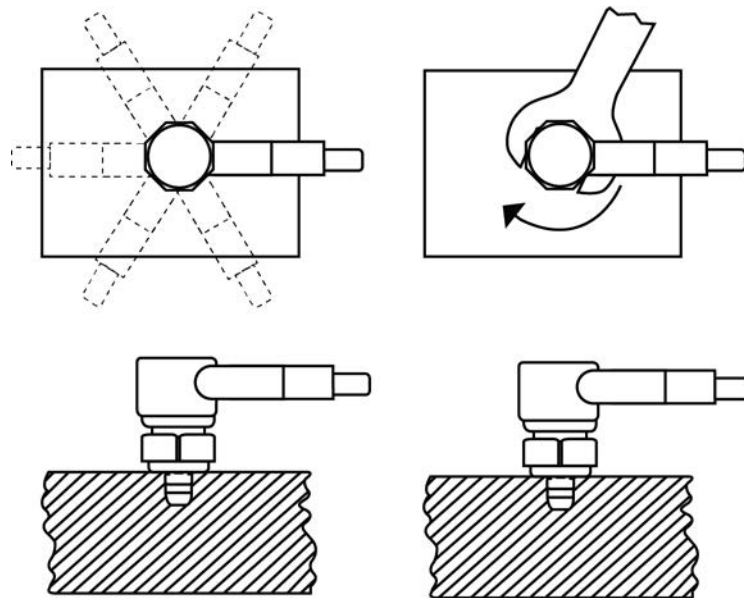

If the mounting stud does not disengage from the sensor, use a flathead screwdriver to hold the stud and turn the hex nut counter-clockwise with a wrench.

2.1.6 Secure the sensor cables

⚠ WARNING

All wiring should be installed by a trained and qualified electrician. Wiring must conform to all applicable local codes and regulations. Follow local codes and regulations regarding wire type, wire size, color codes, insulation voltage ratings, and any other standards.

Using an appropriately sized cable clamp, secure the sensor cable to the machine approximately 4–5 in. (100–125 mm) from the mounting location. Do not curl into a bending radius of less than 2.8 in. (71 mm).

Figure 2-7: Securing a cable with temporary cable anchor

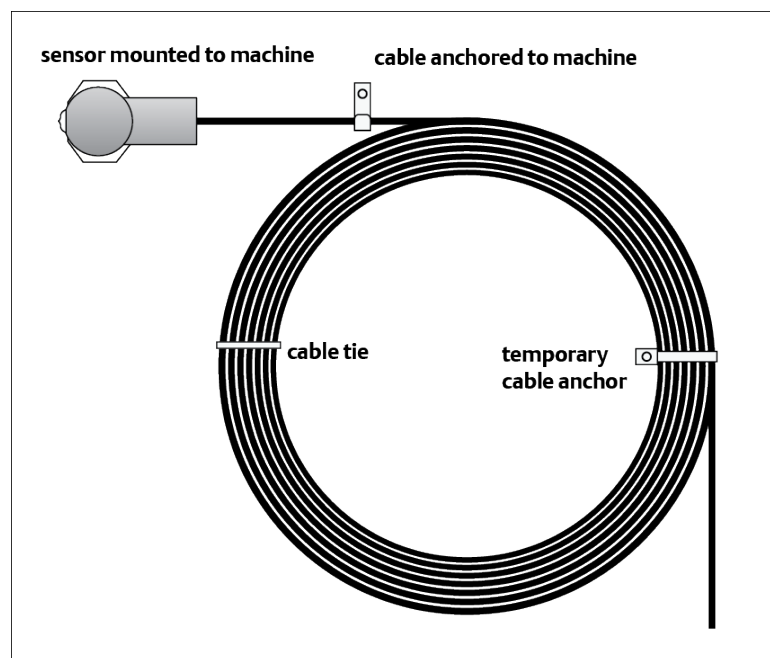

If the pulling of cables is not currently scheduled, secure the bundled sensor cables so that no strain is placed on the integral sensor/cable connectors. Do not let the bundled cable hang from the sensors. Do not place cables on plant floors, maintenance access areas, and/or footholds that may cause damage to the cables.

2.1.7 Conduit installation guidelines

⚠ WARNING

All wiring should be installed by a trained and qualified electrician. Wiring must conform to all applicable local codes and regulations.

- Adhere to IEEE 1100 specifications for grounding.
- Do not exceed a 40 percent fill for conduits.
- Route the conduit away from power trays using these guidelines:

6 in.	110 VAC
12 in.	220 VAC
24 in.	440 VAC

- Attach the conduit to the NPT threaded holes on the side of the AMS 9420.

2.1.8 Cable entry port installation guidelines

Power leads and sensor leads enter the rear compartment of the transmitter housing through conduit openings on the left and right of the housing. Power leads and sensor leads must enter on opposite sides of the housing. Emerson recommends the sensor leads enter the same side where the sensor terminal screws are located. Depending on how the transmitter is powered, you may need to install two sensor cables into one cable entry port. When the transmitter uses a power module, both cable entry points are available for use with sensors. You can use the standard cable glands included with the transmitter for one sensor cable per cable gland. The included cable gland is not approved for use with two sensor cables. When the transmitter uses external DC power, an extra conduit body is required, and both sensor leads enter the same conduit opening. Refer to the installation drawing for details.

Note

Use cable glands to seal the cable entry ports. Ensure that the cable gland grommet fits the wire properly and does not leak. The wire must snugly fit in the grommet feed-through in the cable gland to prevent ingress of water and other contaminants. If using one of the grommets for the standard low-power accelerometers, use a cable with a diameter between 0.125 to 0.250 in. (3.175 - 6.35 mm) to maintain a good seal. If a good seal is not possible with the wire selected, use an alternative grommet that provides a good seal.

The following figures show suggested installations.

Figure 2-8: AMS 9420 with extended power module and two sensors

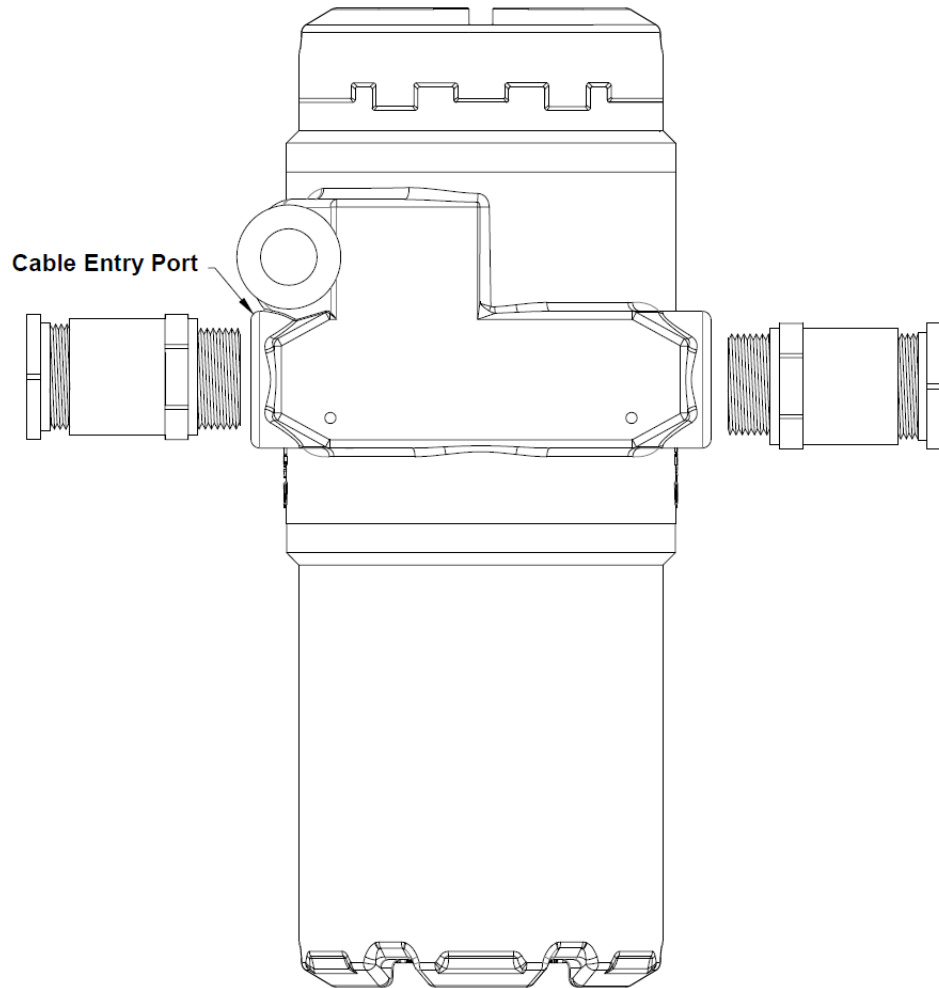
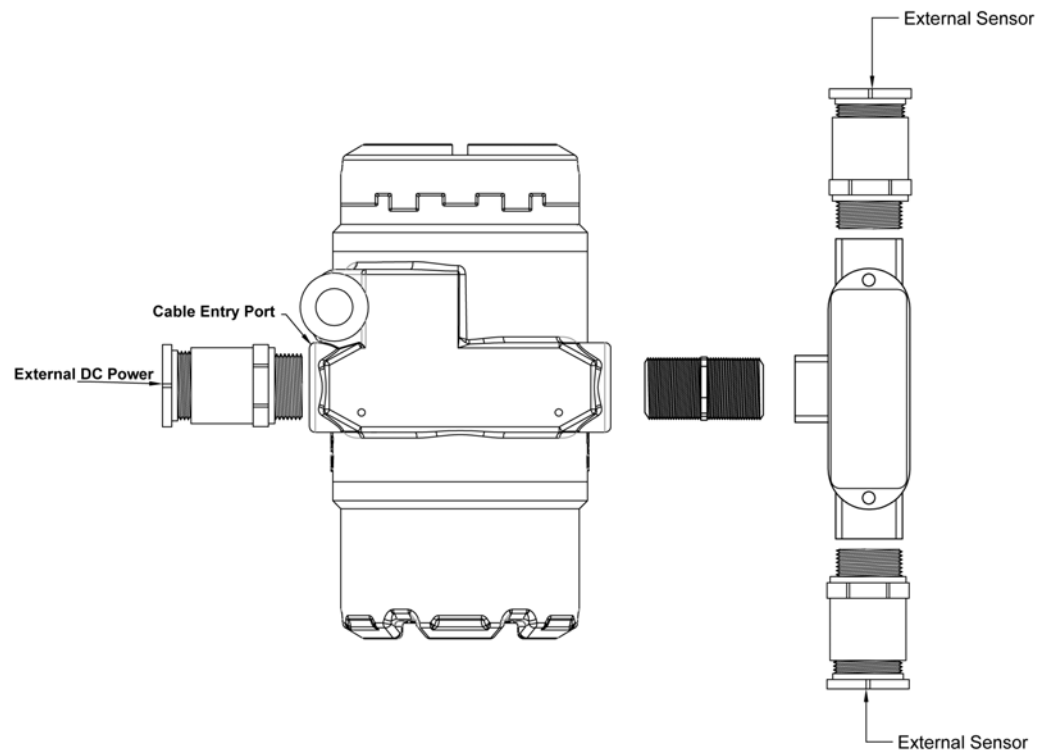

Figure 2-9: AMS 9420 with external DC power and two sensors



Notes

- When using two sensors with external DC power a dual cable gland adapter is required (e.g. 'T'-adapter shown in [Figure 2-9](#)).
- An external earth connection, where applicable, should be made to the earth grounding point on the bottom of the housing.
- If using a Stainless Steel housing, stainless steel adapters/glands are also recommended.
- To ensure long term reliability a minimum of IP56 or NEMA 4 sealing is recommended for the full assembly.
- All local wiring codes and regulations shall be followed.

When installed in a hazardous location, the following practices are also required:

- Both sensors must enter through the dual cable gland adapter with one sensor per entry.
- The full assembly shall maintain a minimum IP rating of IP20.
- Field wiring using multiconductor cable shall either have each conductor enclosed in grounded metal shield or each conductor have a minimum of 0.25 mm (0.01 in) insulation thickness.

2.1.9 Attach sensor wiring to the AMS 9420 terminals

Prerequisites

This procedure applies to a typical AMS 9420 installation with low-power sensors. Low-power accelerometers connect directly to the transmitter terminal block. For information about using ICP[®] accelerometers, refer to [Power the AMS 9420 with external DC power](#).

- If you are using armor-jacketed cable longer than 3 meters, you must attach the ferrites before attaching sensor wiring the AMS 9420 terminals. See [Attach 3 ferrites to an accelerometer with armor-jacketed cable](#).
- If the sensor signal wires are not equipped with spade lugs, Emerson recommends installing them before proceeding.

Procedure

1. Tie the sensor's grounding wire (white with black stripe) to the ground screw inside the AMS 9420.
See callout E in the figures below.
2. Refer to the appropriate figure to connect the sensor signal wires.

Note

You can connect one or two accelerometers to the AMS 9420. You can connect only one accelerometer with a temperature sensor.

- a) Insert a beryllium copper washer on top of each spade lug.
- b) Tighten the screw to 15 in-lbs (1.7 N-m).

Figure 2-10: AMS 9420 wiring with one accelerometer

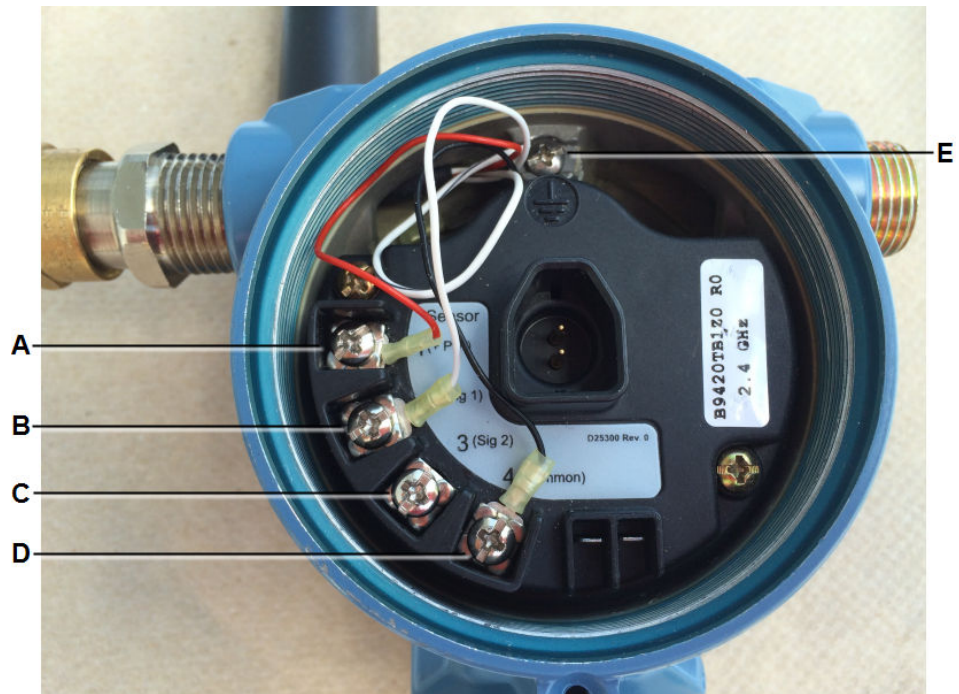

A	Sensor power	Red wire
B	Sensor signal	White wire
C	Unused	Unused
D	Sensor common	Black wire
E	Sensor grounding	White wire with black stripe

Figure 2-11: AMS 9420 wiring with two accelerometers

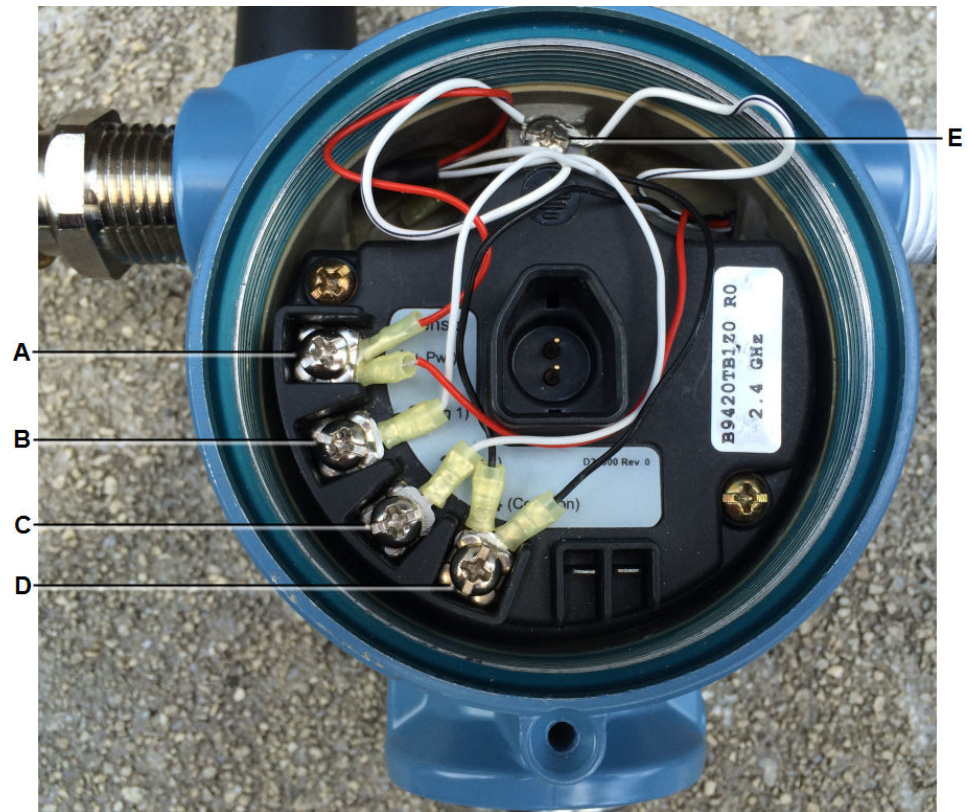

A	Sensor power	2 red wires
B	Sensor 1 signal	White wire
C	Sensor 2 signal	White wire
D	Sensor common	2 black wires
E	Sensor grounding	2 white wires with black stripe

Figure 2-12: AMS 9420 wiring with one accelerometer with embedded temperature

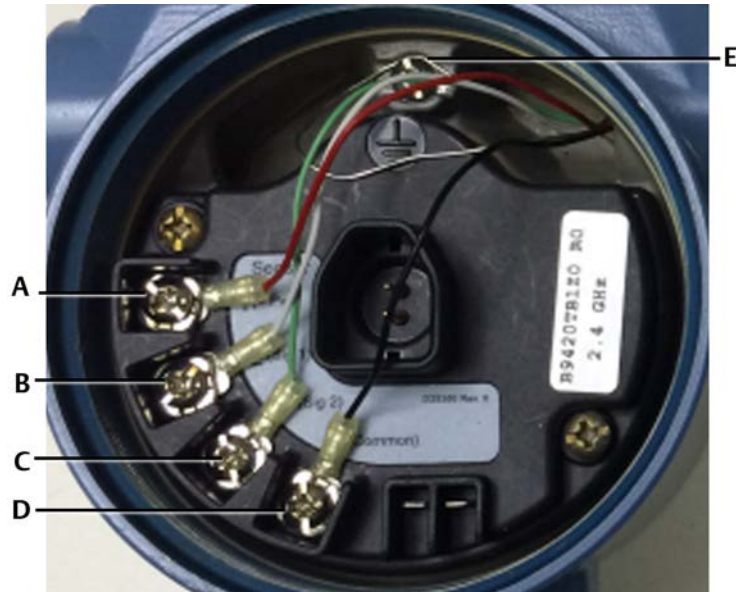

A	Sensor power	Red wire
B	Vibration signal (Signal 1)	White wire
C	Temperature signal (Signal 2)	Green wire
D	Sensor common	Black wire
E	Sensor grounding	Bare wire

2.2 Power the AMS 9420 with a power module

Emerson offers power modules to power the AMS 9420 for typical applications. The power module package includes more documentation. This section includes examples of using the Blue Power Module with the AMS 9420.

2.2.1 Power module installation and replacement

There are two power modules that may be used with the AMS 9420.

Where approved for use, Emerson recommends using the blue power module. The blue power module is equipped with two "D" size primary lithium/thionyl chloride cells, and features special power management circuitry for optimum performance with the AMS 9420. Each blue power module contains approximately 10 grams of lithium.

The black power module contains two "C" size primary lithium/thionyl chloride batteries. The black power module contains approximately 5 grams of lithium; therefore, the blue power module will operate the AMS 9420 for approximately twice as long as the black power module.

Actual power module life can vary dramatically based on the power module being used and on operating parameters, including whether high-resolution data such as vibration waveforms and/or spectra are being retrieved from the device.

Under normal conditions, power module materials are self-contained and not reactive as long as the integrity of the batteries and power module pack are maintained. Take care to prevent thermal, electrical, or mechanical damage, and protect contacts to prevent premature discharge.

Upgrading

If you need to upgrade from black power module to a blue power module, Emerson personnel must apply a new label to your transmitter.

Note

When upgrading from the black power module to the blue power module, be sure to order an extended battery cover for each blue power module. To order an extended battery cover for the blue aluminum housing or the stainless steel housing, contact your local sales representative.

Handling

Under normal conditions, the power module materials are self-contained and are not reactive as long as the batteries and the power module pack integrity are maintained. Take care to prevent thermal, electrical, or mechanical damage. Protect the contacts to prevent premature discharge.

⚠ CAUTION

Use caution when handling the power module pack. The power module pack can be damaged if dropped from heights in excess of 20 feet.

⚠ WARNING

Power module hazards remain even when cells are discharged.

Environmental considerations

As with any battery, consult local, national, and international environmental rules and regulations for proper management of spent batteries. If no specific requirements exist, you are encouraged to recycle through a qualified recycler. Consult the materials safety data sheet for power module-specific information.

Shipping

The unit is shipped without the power module installed. Unless you are specifically instructed to do otherwise, always remove the power module pack from the unit prior to shipping.

The U.S. Department of Transportation, International Air Transport Association (IATA), International Civil Aviation Organization (ICAO), and European Ground Transportation of Dangerous Goods (ADR) regulate the transportation of primary lithium batteries

The shipper is responsible for complying with these or any other local requirements. Consult current regulations and requirements before shipping.

2.2.2 Physical installation

The Blue Power Module (A0701PBU) has been designed with safety in mind. The connector is keyed so that it cannot be inserted incorrectly, and it uses a patented mechanism that enables it to be replaced while the transmitter is installed in a hazardous area. The installation procedure includes replacing the power module and extended battery cover.

Prerequisites

When replacing a standard Black Power Module with the extended life Blue Power Module, you also need to replace the smaller end cap (2.5 in / 70 mm) with the extended end cap (4.5 in / 115 mm).

Procedure

1. Inspect the power module for any obvious signs of damage.
Emerson's SmartPower Power Modules are designed to be rugged. The product design has been tested in environmental conditions such as extreme temperature, pressure, vibration and shock. In testing, it also was dropped repeatedly from 3m height without leading to an unsafe operating condition.
If there are any obvious signs of damage, do not install the power module. Refer to the Blue Power Module documentation for disposal or recycling of the power module.
2. Unscrew the power module cover from the AMS 9420.
3. Connect the power module to the AMS 9420. The power module has a keyed connection to prevent improper connection.

Figure 2-13: Blue Power Module (A0701PBU) connects using a keyed connection

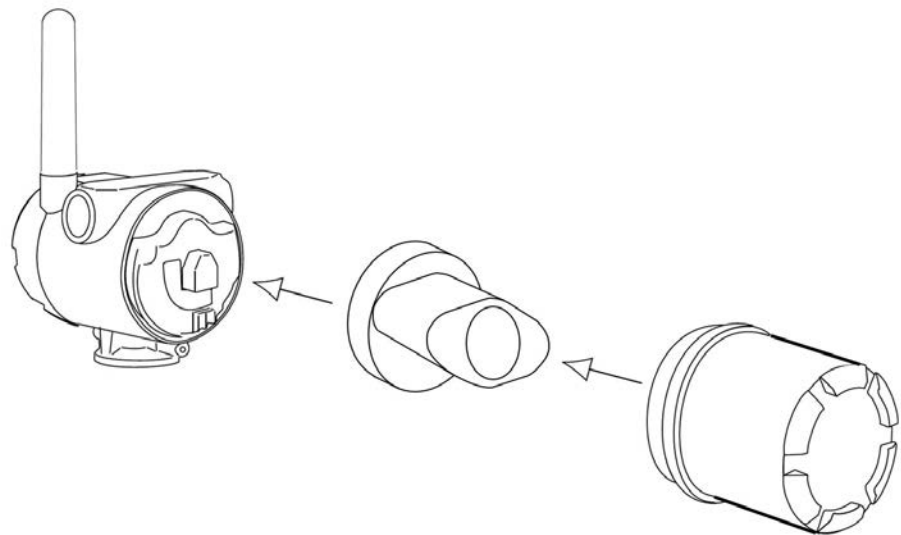

Note

Power up wireless devices in order of proximity from the Emerson Wireless Gateway, beginning with the closest. This will result in a simpler and faster network installation.

4. Close the extended end cap on the housing and tighten. Always ensure a proper seal by installing the electronics housing covers so that metal touches metal, but do not over tighten.

2.3 Power the AMS 9420 with external DC power

Emerson offers Emerson A9000P series adapters to power the AMS 9420 with external DC power. The adapter package includes documentation, installation drawings, and other important instructions. You can also find the quick start guide on our website. This section includes some examples of using the power adapter with the AMS 9420.

2.3.1 Emerson A9000P description of intended use

The Emerson A9000P series adapters are available in two versions: Emerson A9000PA and Emerson A9000PS-A. They allow an Emerson wireless transmitter to be powered by external DC power. When installed with an appropriate safety barrier, they can be used in a hazardous location. Barrier requirements are described in the Emerson A9000Px Quick Start Guide and installation drawings included with the power adapter.

- Use either version to connect external DC power.
- Use the Emerson A9000PS-A to connect external DC power and up to 2 standard ICP accelerometers with a nominal sensitivity of 100 mV/g.

Figure 2-14: Emerson A9000PA (left) and Emerson A9000PS-A (right)



2.3.2 Optional spacer

The spacer is required only when the transmitter has an extended endcap.

Figure 2-15: Optional spacer



2.3.3 Connect external DC power to Emerson wireless transmitters

You can use all versions of the Emerson A9000P series adapters to connect external DC power to Emerson wireless transmitters. This example describes connecting the power adapter.

⚠ CAUTION

DC power should only be applied to the power adapter after it is wired and inserted in the transmitter terminal block.

Procedure

1. Connect the external DC power to the power adapter.
2. Connect the included green chassis ground cable to the power adapter ground and to the chassis ground point.

The connections are shown in detail in the installation drawing and an example is shown in [Figure 2-16](#).

Figure 2-16: External DC power and included cable harness connected to the power adapter

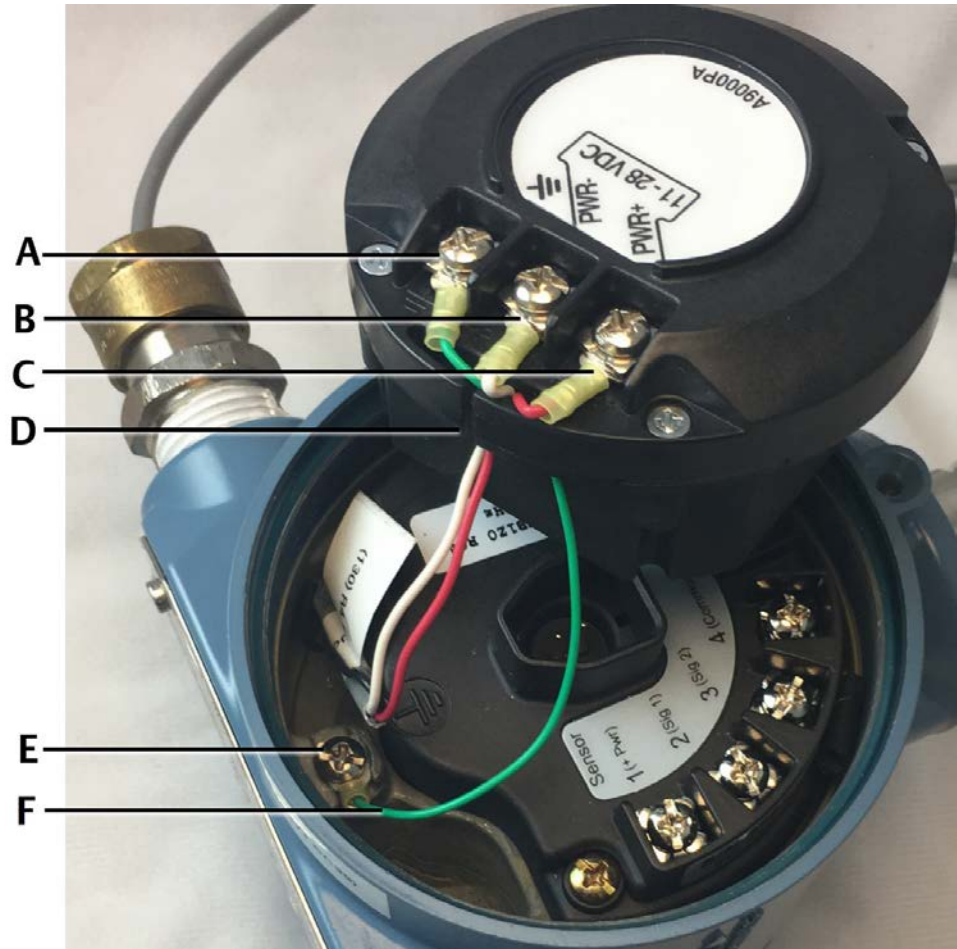

- A. Green chassis ground cable
- B. PWR -
- C. PWR +
- D. Slot
- E. Chassis ground point
- F. Green chassis ground cable

3. Push each wire through the slot.
4. Insert the power adapter into the receptacle on the transmitter terminal block.
5. If the transmitter has an extended end cap, insert the spacer into the end cap. Otherwise, the spacer is not required.

2.3.4 Connect external DC power and ICP[®] accelerometer inputs to an AMS 9420

With the AMS 9420, use the Emerson A9000PS-A to connect external DC power and up to 2 standard ICP[®] accelerometers with a nominal sensitivity of 100 mV/g. This example describes connecting the power adapter.

Note

For a typical AMS 9420 installation, only connect external DC power to the power adapter. Low-power accelerometers connect directly to the transmitter terminal block.

⚠ CAUTION

DC power should only be applied to the power adapter after it is wired and inserted in the transmitter terminal block.

Prerequisites

Connect external DC power and green chassis ground cable to the power adapter. Refer to the example in [Connect external DC power to Emerson wireless transmitters](#).

Procedure

1. Use the included cable harness to connect the power adapter sensor terminals to the AMS 9420, as shown in the installation drawing.

The cable harness has three wires: two colored wires and one bare wire. Each wire has a spade lug on one end and a ferrule on the other end. Connect the spade lugs to the terminal block. Connect the ferrules to the power adapter. Be careful to connect each wire to the matching terminal screw. The connections are shown in detail in the installation drawing and an example is shown in [Figure 2-17](#).

Figure 2-17: Emerson A9000PS-A to AMS 9420 signal connections with included cable harness

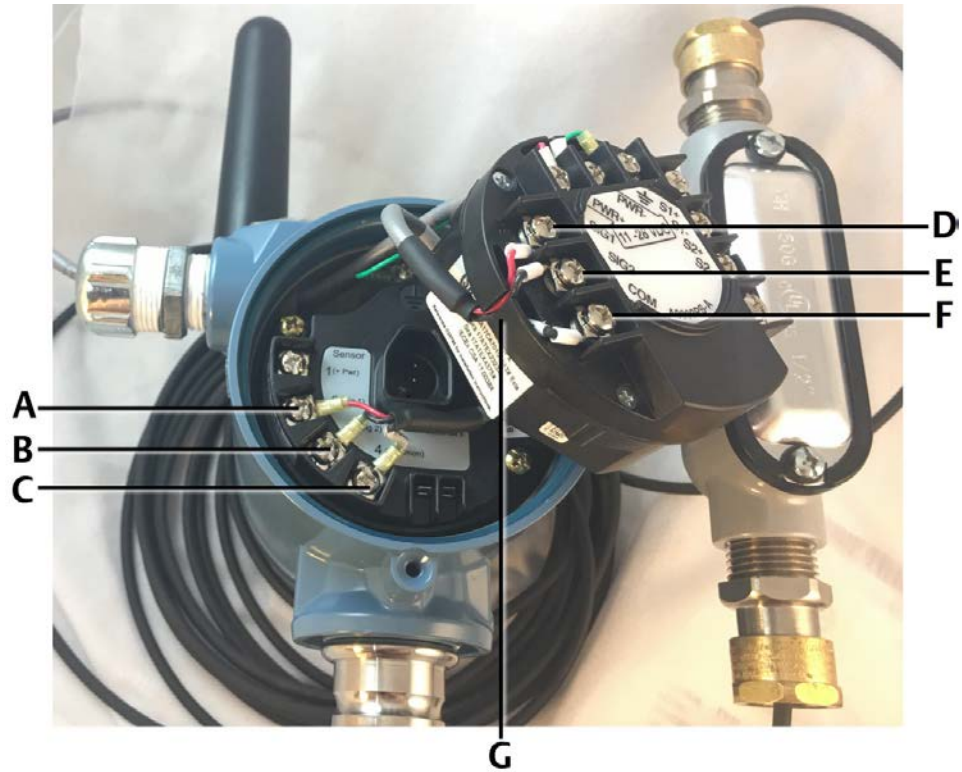

	Spade lug to AMS 9420	Cable harness wire	Ferrule to Emerson A9000PS-A	
A	2 (Sig 1)	color 1 (red shown)	SIG1	D
B	3 (Sig 2)	color 2 (black shown)	SIG2	E
C	4 (Common)	unshielded	COM	F
G	Slot			

2. Push each wire from the cable harness into the slot. It is easier to push the individual wires into the slot after connecting the ferrules.
3. Connect the leads from up to two standard ICP[®] accelerometers with a nominal sensitivity of 100 mV/g to the terminal screws on the Emerson A9000PS-A.

Figure 2-18: Two ICP® accelerometers connected to the power adapter (rotated view)

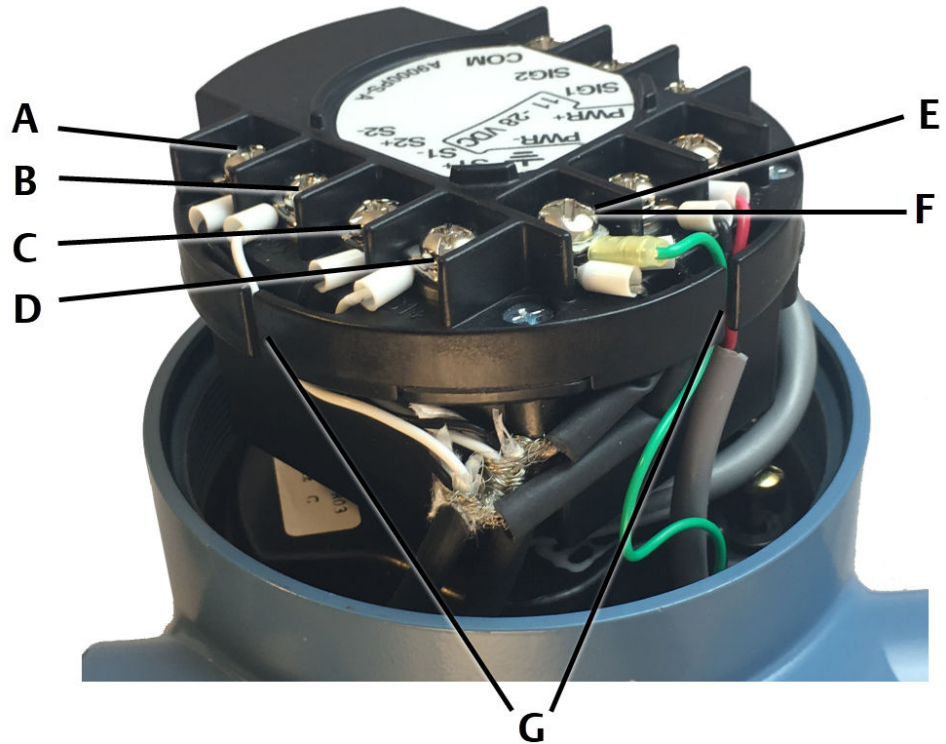

- A. S2-
- B. S2+
- C. S1-
- D. S1+
- E. S1 Shield
- F. S2 Shield
- G. Slots

4. Push each signal cable wire into the slot.
5. Wrap the cable harness counter clockwise around the receptacle on the transmitter terminal block.

Figure 2-19: Cable harness wrapped around the receptacle



6. Insert the power adapter into the receptacle.
7. If the transmitter has an extended end cap, insert the spacer into the end cap. Otherwise, the spacer is not required.

2.4 Install the end cap

Note

If you have configured the sensor and network but are not ready to commission the device, remove the power module to extend operating life.

Prerequisites

Ensure you have the appropriate end cap and spacer as required for your application.

Procedure

1. If required for your application, insert the spacer between the power module or power adapter and the extended end cap.
2. Attach the end cap.

Always ensure a proper seal by installing the housing cover so that metal touches metal and the black O-ring is no longer visible, but do not over tighten. A tight seal ensures that water, water vapor, or other gases do not penetrate into the housing.

Figure 2-20: Sealing the end cap

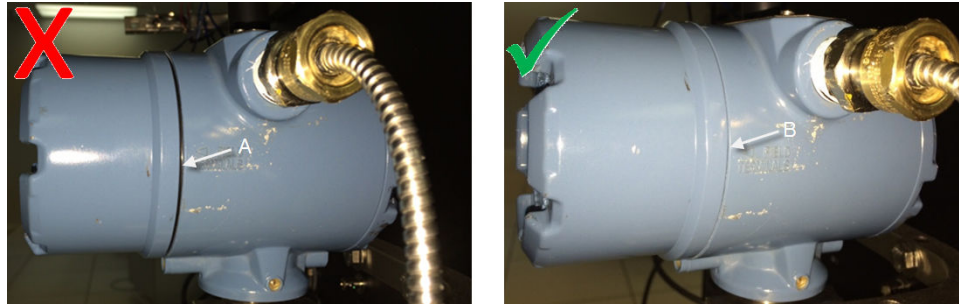

- A. Improperly sealed end cap. Black O-ring is still visible.*
B. Properly sealed end cap. Black O-ring is no longer visible.

3. Use a strapping wrench to tighten the housing cover to safety specification.
Always ensure a proper seal by installing the housing cover so that metal touches metal and the black O-ring is no longer visible, but do not over tighten. A tight seal ensures that water, water vapor, or other gases do not penetrate into the housing.

2.5 Position the antenna

Procedure

Position the antenna so it points upward, for optimal performance.

The antenna should be approximately 3 ft. (1 m) from any large structure, building, or conductive surface to allow for clear communication to other devices.

Figure 2-21: Antenna positions and dimensions

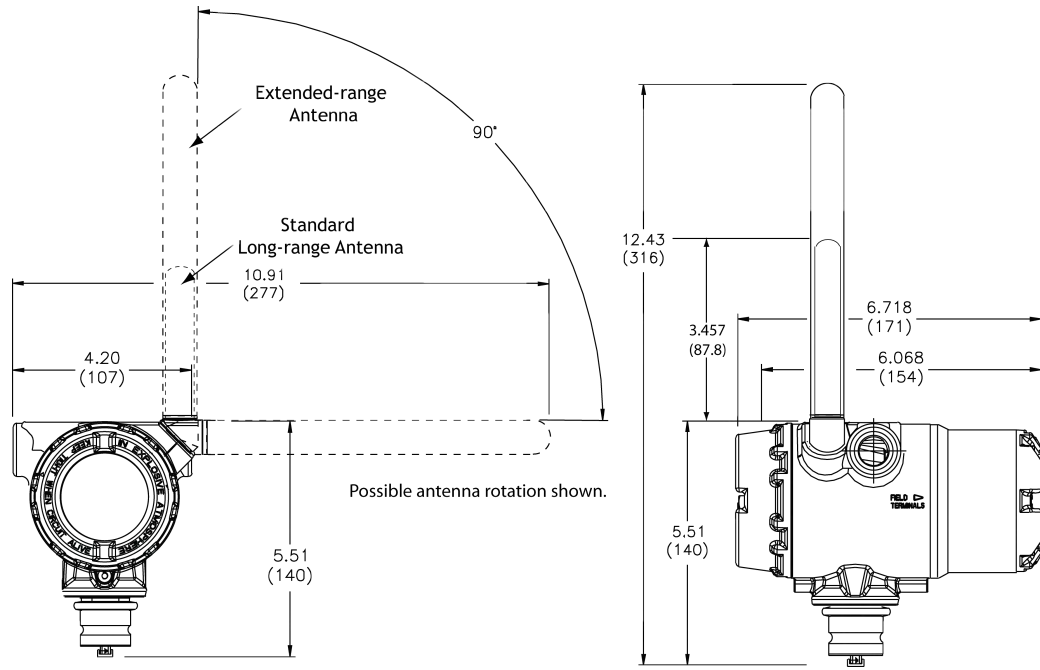

2.6 Liquid Crystal Display (LCD)

If you order an LCD, it is shipped attached to the transmitter.

2.6.1 Rotate the LCD

You may need to rotate the LCD depending on the mounting orientation of the device.

⚠ WARNING

Do not remove the front electronics end cap or LCD cover while the device is in a hazardous area.

Removing the cap while the device is in a hazardous area could cause an explosion which could result in death or serious injury.

⚠ CAUTION

The front electronics end cap or LCD cover is certified for hazardous areas in appropriate gas environments (check the nameplate on the device for details).

Exposing the electronics to a production environment may allow particulates, moisture, and other airborne chemicals to enter into the device, which could lead to contamination and potential product performance issues.

Figure 2-22: Installing the LCD

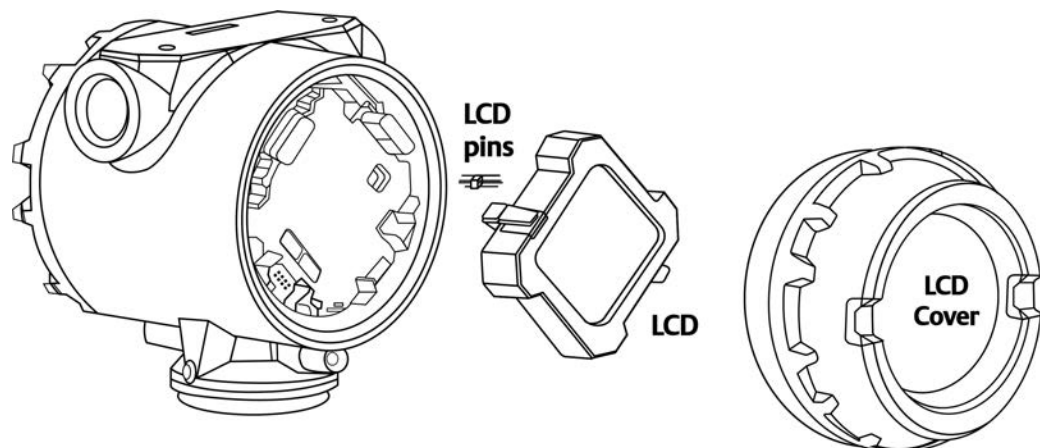

Procedure

1. Remove the LCD cover.
2. Insert the four-pin connector into the interface board, rotate to the correct position, and snap into place.

The pins can be plugged into any one of four locations depending on which angle of rotation is desired for the LCD screen.

If the LCD pins are inadvertently removed from the interface board, carefully re-insert the pins before snapping the LCD in place.

After installation, you can remove the LCD by squeezing the two tabs and pulling gently. You can then rotate it in 90-degree increments and snap it back in place.

3. Attach the LCD cover.

Always ensure a proper seal by installing the housing cover so that metal touches metal and the black O-ring is no longer visible, but do not over tighten. A tight seal ensures that water, water vapor, or other gases do not penetrate into the housing.

Figure 2-23: Sealing the end cap

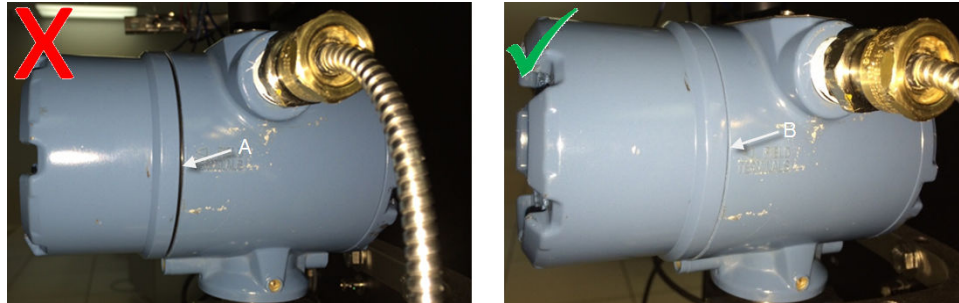

A. Improperly sealed end cap. Black O-ring is still visible.

B. Properly sealed end cap. Black O-ring is no longer visible.

Important

Moving one LCD around to multiple devices, on an “as need” basis, is NOT recommended. This can cause reliability problems over time. The connector pins on the LCD are not designed for repeated connect/disconnect.

2.6.2 Enable the LCD

When you enable the LCD, the AMS 9420 displays information about its network state and its measurements. This is helpful for configuration, installation, and commissioning. The LCD provides a visual indication on the status of the device and shows its current measurements.

Transmitters ordered with the LCD are shipped with the display installed but with the LCD disabled/turned off. You need to enable the LCD using a 475 Field Communicator or using AMS Device Manager.

Enable the LCD using a 475 Field Communicator

1. Use the lead set to connect the Field Communicator to the AMS 9420 terminal block.
2. Turn on the Field Communicator.
3. Select **Configure** → **Manual Setup** → **General Settings** → **LCD Mode** → **Periodic Display**.

Options available for LCD configuration include:

- **Not installed** – Use this setting if the LCD is not installed.

- **Periodic Display** – Use this setting to show only relevant data. This setting does not extend the wake cycle.
- **Troubleshooting Display** – Use this setting when troubleshooting the transmitter.
- **Off** – Use this setting to disable the LCD.

Enable the LCD using AMS Device Manager

1. Launch AMS Device Manager and locate the network where the AMS 9420 is connected.
2. Right-click the AMS 9420 device and select **Configure** → **Manual Setup**.
3. Click the **General Settings** tab and from the **LCD Mode** drop-down menu, select **Periodic Display**.

Options available for LCD configuration include:

- **Not installed** – Use this setting if the LCD is not installed.
- **Periodic Display** – Use this setting to show only relevant data. This setting does not extend the wake cycle.
- **Troubleshooting Display** – Use this setting when troubleshooting the transmitter.
- **Off** – Use this setting to disable the LCD.

Note

When operating the AMS 9420 with the Smart Power Module, disable the LCD in the transmitter configuration after installation to maximize power module life. While the LCD module itself consumes very little power, having it activated will alter the operating cycle of the transmitter in such a way that can impact the power module life by up to 15–20%.

2.6.3 Turn on the LCD

⚠ WARNING

Do not remove the front electronics end cap or LCD cover while the device is in a hazardous area.

Removing the cap while the device is in a hazardous area could cause an explosion which could result in death or serious injury.

⚠ CAUTION

The front electronics end cap or LCD cover is certified for hazardous areas in appropriate gas environments (check the nameplate on the device for details).

Exposing the electronics to a production environment may allow particulates, moisture, and other airborne chemicals to enter into the device, which could lead to contamination and potential product performance issues.

Procedure

1. Remove the LCD cover.
2. Press the **DIAG** button to turn the LCD on.
This displays the Tag name, Device ID, Network ID, Network Join Status, and Device Status screens.
3. Attach the LCD cover.
Use a strapping wrench to tighten the cover until it will no longer turn and the black O-ring is no longer visible. Refer to [Figure 2-23](#) for an illustration on how to properly seal the end cap.

2.7 Ground the transmitter

The transmitter operates with the housing, either floating or grounded. However, the extra noise in floating systems affects many types of readout devices. If the signal appears noisy or erratic, grounding the transmitter at a single point may solve the problem.

You can reduce electrostatic current in the leads induced by electromagnetic interference by shielding. Shielding carries the current to the ground and away from the leads and electronics. If the transmitter end of the shield is adequately grounded to the transmitter and the transmitter is properly grounded to the earth ground, very minimal current enters the transmitter.

If the ends of the shield are left ungrounded, a voltage is created between the shield and the transmitter housing, and between the shield and earth at the element end. The transmitter may not be able to compensate for this voltage, causing it to lose communication and/or generate an alarm. Instead of the shield carrying the current away from the transmitter, the current flows through the sensor leads and into the transmitter circuitry where it interferes with circuit operation.

Each accelerometer contains a drain wire that is connected to the sensor shield. This wire should be connected to the internal grounding screw attached to the housing near the terminal block.

Ground the transmitter in accordance with local, national, and international installation codes. You can ground the transmitter through the process connection, the internal case grounding terminal, or the external grounding terminal.

3 Configure the AMS 9420

Topics:

- [3.1 Configuration overview](#)
- [3.2 Configuration with a Field Communicator](#)
- [3.3 Configuration with AMS Device Manager](#)
- [3.4 Configuration with AMS Machinery Manager](#)

3.1 Configuration overview

You can configure the AMS 9420 either prior to installation or after the device is installed at the measurement location. You do not need to physically install or connect to the transmitter to complete the configuration. The transmitter, however, reports an alert until the sensor is connected; this is the expected behavior.

Note

The specific user interface for performing the configuration varies depending on the host used.

Procedure

1. **Connect to a wired HART interface.**
Skip this step if your AMS 9420 is purchased pre-configured from the factory.
2. **Set the wireless network credentials (Network ID and Join Key) using wired connection.**
Perform this step for the device to join a wireless network. After the device has joined, you can complete the rest of the steps over a wireless link.
3. **(Optional) Name the device (Tag and Device Description).**
By default, the tag is VT xxxx, where xxxx is the unique radio ID on the wireless network. The device joins the network and operates correctly even if no changes are made, but it is usually preferable to name the device something meaningful for the specific application.
4. **Specify the type of sensor installed (for example: 1 accelerometer, 1 accelerometer with temperature, or 2 accelerometers) and name the sensor.**
The factory default configuration is one accelerometer named SENSOR 1. Complete this step for different configurations and name the sensor something meaningful for the specific application.

5. Enter the sensor sensitivity setting.

For improved accuracy, replace the nominal sensitivity value of 25 mV/g (2.55 mV per m/s^2) (default) with the value corresponding to your specific sensor. When using an 100 mV/g sensor with a power adapter, you need to divide the value by four. See [page 53](#).

6. Specify the units (English, metric, or SI) that will be used for each parameter.

By default, units are set to English, unless the device is shipped to Japan.

7. Specify which measurements (velocity, temperature, etc.) correspond to the process variables PV, SV, TV, and QV.

By default, PV is the Overall Velocity on sensor 1, SV is the PeakVue measurement on sensor 1, TV is the sensor 1 bias voltage, and QV is the supply voltage.

8. Specify alert levels.

Determine the thresholds at which measurement alerts will display and determine the behavior of device alerts.

9. Specify how the parameters will be published (optimized mode or generic mode).

By default, the device is configured to use generic mode as it provides the most consistent overall performance.

10. Specify how often the parameters are published (update rate).

The default update rate is once every 60 minutes. A faster update rate is not recommended, unless the device is powered by an external power source, as it significantly reduces the power module life.

11. Optimize for power consumption.

Reduce the publish rate and set the LCD mode to Off to minimize power consumption. As an additional step, you can configure the PowerSave mode settings to extend the power module life.

12. Configure trending of parameters.

You can trend parameters in multiple locations such as in a plant historian, in AMS Machinery Manager, and in a DCS control system.

13. If the device configuration will not be managed by a HART DCS (such as DeltaV), specify whether AMS Machinery Manager can make configuration changes.

By default, the device is set for a DCS to manage the configuration, and changes from AMS Machinery Manager are not permitted. You can, however, allow AMS Machinery Manager to make configuration changes by enabling MHM Access Control from AMS Device Manager or from a Field Communicator.

14. If the device is licensed for the Advanced Diagnostics application (spectral data retrieval), configure storage of energy bands, spectra, and waveforms in the AMS Machinery Manager database.

With the Advanced Diagnostics application, you can collect data on-demand, automatically at periodic intervals, or on alert. Store on Alert is the recommended operating mode.

3.1.1 Connect to a wired HART interface

Unless the AMS 9420 is purchased pre-configured from the factory, you must connect it to a wired HART interface. This is to define device credentials that allow the device to communicate on your wireless network. You can also define other device configurations such as sensor type and alert thresholds at this time.

Notes

- Use the wired HART interface only for configuration. Dynamic variables (such as measured vibration parameters) are not updated when communicating on the wired interface.
- The AMS 9420 does not communicate simultaneously on both the wired and wireless HART interfaces. You will lose wireless connectivity when you connect to the wired HART interface. Configuration changes are not reflected in a wireless host until connection has been re-established. To avoid loss of synchronization, disconnect hosts relying on the wireless link when communicating with the device on the wired interface.

For example, if you are viewing a configuration screen in AMS Device Manager through a wireless link, and you leave this screen open while making changes with a Field Communicator, you will have to exit AMS Device Manager and then re-open it (or re-scan the device) after the wireless connection has been restored in order to see the changes.

Procedure

1. Remove the transmitter back cover.
This exposes the terminal block and HART communication terminals.

Figure 3-1: AMS 9420 terminal block

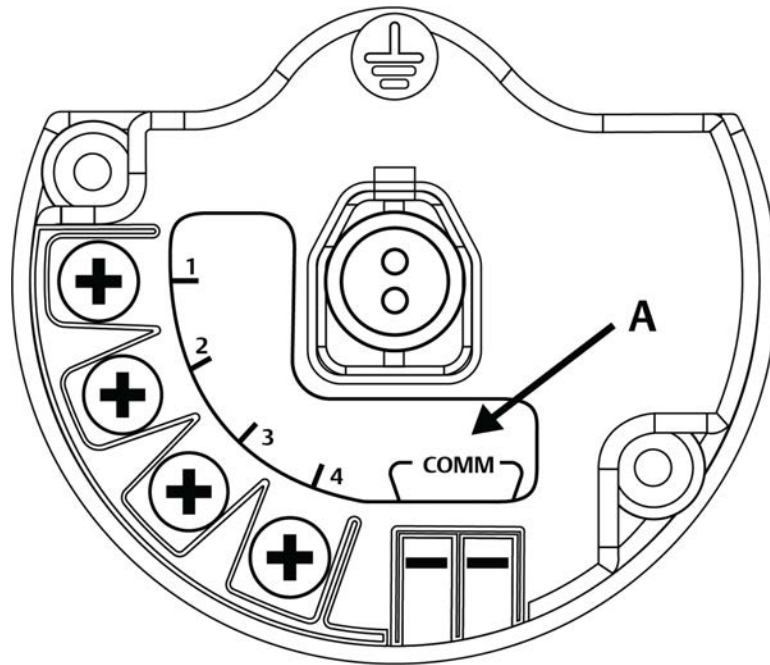

A. AMS 9420 COMM terminals (power module version)

2. Connect a power module, if there is not a power source already such as the power adapter.

Figure 3-2: Field Communicator and power module connection

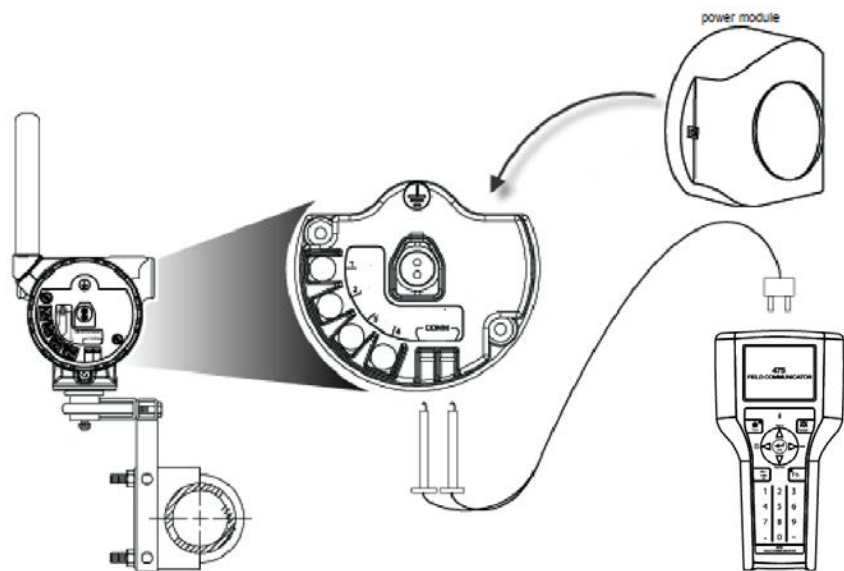

3. Configure using a Field Communicator, AMS Device Manager, or any HART-enabled host.

Press **Send** to send configuration changes to the transmitter.

The AMS 9420 enters “HART Listen” mode for communication on the wired interface. HART Listen is displayed on the optional LCD, if it is installed.

If the device is unable to enter the HART Listen mode during its boot sequence or while performing its real-time vibration measurement, retry the initial wired HART handshaking sequence.

If repeated attempts to establish wired communication fail, you can force the device into a HART Listen mode. When in a safe location, remove the transmitter front cover and press the **CONFIG** button once. The device enters HART Listen mode, and it remains in this mode until you press the CONFIG button, the power cycles, or no activity is seen on the wired interface for three minutes. Pressing the CONFIG button a second time causes the device to exit HART Listen mode.

⚠ WARNING

Do not remove the front electronics end cap or LCD cover while the device is in a hazardous area.

Removing the cap while the device is in a hazardous area could cause an explosion which could result in death or serious injury.

⚠ CAUTION

The front electronics end cap or LCD cover is certified for hazardous areas in appropriate gas environments (check the nameplate on the device for details).

Exposing the electronics to a production environment may allow particulates, moisture, and other airborne chemicals to enter into the device, which could lead to contamination and potential product performance issues. In all cases, whenever opening the front end cap, be sure to seal it completely afterwards by tightening until the black O-ring is no longer visible. For an illustration on how to properly seal the end cap, see [Figure 2-23](#).

4. When configuration is complete over the wired HART interface, disconnect the transmitter from the communication wires to re-establish wireless communication. This may take several minutes.

3.1.2 Set the wireless network configuration

This enables the transmitter to communicate with the Emerson Wireless Gateway and with other systems. This is the wireless equivalent of connecting wires from a transmitter to a control system input.

Procedure

1. From the Emerson Wireless Gateway, click **System Settings** → **Network** → **Network Settings** to obtain the Network ID and Join Key.
2. Using a Field Communicator or AMS Device Manager with a wired modem, enter the Network ID and Join Key so that they match the Network ID and Join Key from the Emerson Wireless Gateway.

Note

If the Network ID and Join Key are not identical to the gateway settings, the AMS 9420 will not communicate with the network.

3.1.3 Configuration options

The AMS 9420 configuration options control the following operations:

- How measurement results are reported and how often are they reported
- The number and type of sensors installed
- How and when alerts are generated

Table 3-1 shows the default device configuration. You can change these configurations from AMS Device Manager or from a Field Communicator.

Table 3-1: Default device configuration

Configuration option	Default value
Publishing mode	Generic
Update rate	60 minutes
PowerSave mode	PowerSave Skip Multiplier of 1X
LCD mode	Off
Power source	Power module/battery
MHM Access Control	Disabled
Write Protect	No
Sensor Configuration	
Sensor type	1 Accelerometer (sensor 2 not installed)
Sensor sensitivity setting	25 m V/g
Velocity Fmax	1000 Hz
PeakVue true Fmax	1000 Hz
Velocity spectrum lines of resolution	400 lines
PeakVue spectrum lines of resolution	1600 lines
Units	English Overall velocity: in/s RMS PeakVue: g's peak Temperature: °C
Variable mappings	
PV	Overall velocity, sensor 1
SV	PeakVue, sensor 1
TV	Bias, sensor 1
QV	Supply voltage

3.1.4 Sensor configuration

Possible sensor configurations and variable mappings

The AMS 9420 can be installed with two accelerometers, or with one accelerometer with an embedded temperature sensor. Table 3-2 shows the possible sensor configurations and variable mappings.

Table 3-2: Possible sensor configurations and variable mappings

Dynamic process variables	Available process variables based on sensor configuration		
	Sensor 1: Accelerometer Sensor 2: Not Installed	Sensor 1 and 2: Accelerometer with Temperature	Sensor 1: Accelerometer Sensor 2: Accelerometer
PV	Overall Velocity Sensor 1	Overall Velocity Sensor 1	Overall Velocity Sensor 1
SV	PeakVue Sensor 1	PeakVue Sensor 1	PeakVue Sensor 1
TV	Bias Sensor 1	Sensor Temperature	Overall Velocity Sensor 2
QV	Supply Voltage	Supply Voltage	PeakVue Sensor 2
Unmapped device variables	Ambient Temperature	Ambient Temperature Bias Sensor 1	Bias Sensor 1 Bias Sensor 2 Ambient Temperature Supply Voltage

Sensor sensitivity setting

The AMS 9420 does not know if whether you have connected the low-power sensors directly to the terminal block or if you have connected standard 100 mV/g ICP® sensors through the Emerson A9000PS-A adapter. In both cases, it expects to see a sensor sensitivity of 25 mV/g, which is the default setting for an AMS 9420.

For the sensor sensitivity setting, you can leave setting in the DD at the nominal value (i.e. 25 mV/g), or you may enter the actual sensitivity documented on the calibration sheet for the accelerometer. If this is a low power sensor, this value will usually be between 24 and 26 mV/g. Simply enter this into the DD for the sensitivity of that sensor.

For a 100 mV/g sensor, you will need to divide the actual sensitivity by 4, and enter that value into the DD. For instance, if the actual sensitivity of an ICP sensor is 96.4 mV/g, then you would divide by 4 and enter 24.1 mV/g.

Each sensor is characterized at the factory to determine the precise sensitivity. For a standard low-power sensor provided by Emerson, this information is included with the sensor, in the form of a certificate, and may be cross-referenced with the serial number as shown in Figure 3-3.

Figure 3-3: Calibration certificate



3.1.5 Measurement parameter units

Table 3-3 shows the measurement parameters and available units that can be configured for each parameter.

Table 3-3: Measurement parameter units

Parameter	Units
Velocity (Overall 1, Overall 2)	mm/s RMS in/s RMS
PeakVue maximum value (PeakVue 1, PeakVue 2)	m/s ² g's
Temperature (Temperature 2, Ambient)	°C °F
Sensor Bias (Bias 1, Bias 2)	V
Supply Voltage	V

3.1.6 Alert levels

The AMS 9420 sets HART status bits to indicate when measured values exceed the configured thresholds. Each measured value has three levels: Advisory, Maintenance, and Failed that can be set independently. These thresholds are pre-configured at the factory to reasonable generic values for single-stage, electric motor-driven equipment trains operating at 1200–3600 RPM.

The level at which these thresholds should be set depends on the type of equipment being monitored and on your specific process.

One rule of thumb for vibration is to examine the current level at which the equipment is operating. Assuming the equipment is in good working condition, set the Advisory level at 2x the current value (or at a minimum of 0.05 in/s RMS, whichever is greater), set the Maintenance level at 4x the current value, and set the Failed level at 8x the current value. For example, if the current value for Overall Velocity is 0.1 in/s, set the Advisory threshold at 0.2 in/s, the Maintenance threshold at 0.4 in/s and the Failed threshold at 0.8 in/s. While this type of vibration program is not recommended, it can provide a starting point when no other information is available.

Table 3-4: Default alert thresholds for vibration

Alert limits	Advise		Maintenance		Failed	
	Default value	Report notification	Default value	Report notification	Default value	Report notification
Overall velocity (sensor 1, 2)	0.14 in/sec 3.556 mm/s	Yes	0.35 in/sec 8.89 mm/s	Yes	1 in/sec 25.4 mm/s	Yes
PeakVue (sensor 1, 2)	6 g's 58.8399 m/s ²	Yes	10 g's 98.0665 m/s ²	Yes	15 g's 147.09975 m/s ²	Yes
Sensor temperature	65°C 149°F	Yes	75°C 167°F	Yes	85°C 185°F	Yes

Table 3-4: Default alert thresholds for vibration (continued)

Alert limits	Advise		Maintenance		Failed	
	Default value	Report notification	Default value	Report notification	Default value	Report notification
Bias (sensor 1, 2)	-	-	-	-	Above: >3V Below: <2V	Yes*
Ambient temperature	-	-	-	-	Above: 85°C (185°F)* Below: -40°C (-40°F)*	Yes*
Supply voltage	<6.0 V	No	<5.7 V	Yes	<5.3 V*	Yes

*These are read-only parameters and cannot be modified.

A good rule of thumb for establishing the PeakVue alert levels is to use the rule of 10's. This applies for most rolling element bearing equipment with a turning speed between 900 and 4000 CPM. Using this approach, the Advisory alert would be set at 10 g's, the Maintenance alert at 20 g's, and the Failed alert at 40 g's. In general, PeakVue alert levels can then be interpreted as follows:

10 g's	Indication of Abnormal Situation
20 g's	Serious Abnormal Situation - Maintenance Plan Required
40 g's	Critical Abnormal Situation - Implement Maintenance Plan

For more information on PeakVue, see [PeakVue](#).

The default alert thresholds for temperature correspond closely to a generic open drip-proof (ODP) motor with class F insulation and a service factor of 1.15, operating at an ambient temperature of 40°C or below and at an altitude of 1000 meters or below. These values are also reasonable thresholds to use when there is no knowledge of the process, the type of machinery, or the operating environment. For more information, see [Overall Velocity, PeakVue, and temperature](#).

Table 3-5: Default alert thresholds for temperature

Parameter	Advisory		Maintenance		Failed	
	Level	Enabled	Level	Enabled	Level	Enabled
Temperature	149°F (65°C)	Yes	167°F (75°C)	Yes	185°F (85°C)	Yes

The configurable device alerts include accelerometer bias and supply voltage. The default settings for these alerts are shown in [Table 3-6](#).

Table 3-6: Default levels for configurable device alerts

Parameter	Advisory		Maintenance		Failed	
	Level	Enabled	Level	Enabled	Level	Enabled
Accelerometer Bias	N/A	N/A	N/A	N/A	< 2 V or > 3 V	Yes
Supply Voltage	< 6.0 V	No	< 5.7 V	Yes	< 5.3 V	Yes

Notes

- The supply voltage measurement is made under load conditions. The supply voltage may read differently with the AMS 9420 versus other Emerson transmitters or multimeters.
- Prior to sensor connection, it is normal to see alerts related to bias failure. These alerts go away when the sensor is installed correctly.
- When any measured process parameter (Velocity, PeakVue, or Temperature) exceeds the configured Advisory, Maintenance, or Failed threshold, this causes an “Advisory” indication that you can view from AMS Device Manager (or in another graphical host). This indicator itself does not set a status bit.

3.1.7 Publishing mode

The AMS 9420 can publish in either of two modes: optimized or generic (default).

Optimized mode uses less power by combining a large amount of information into a single command. In this mode, only the four standard process variables (PV, SV, TV, and QV) are published at the specified update interval and cached in the Smart Wireless Gateway. When values are cached in the gateway, it is not necessary to wake the device for the host system to be able to read the variables. The other variables are still available, but any request to read one of them wakes the device and consumes power.

Generic mode publishes all the process variables the device can produce. This mode requires three publish messages, which requires approximately 5% more power.

If you are only trending measurements mapped to PV, SV, TV, and QV, use optimized mode. If you are trending additional variables, use generic mode.

The following table shows a typical mapping example and what is included in optimized mode and generic mode.

Table 3-7: Typical mapping example showing optimized and generic mode

	Parameter	Value Type	Metric Units	Emerson Optimized Mode	Generic Burst Mode
Process Variables	Overall Velocity 1	Real Number	mm/s	•	•
	PeakVue 1	Real Number	g's	•	•
	Overall Velocity 2	Real Number	mm/s	•	•
	PeakVue 2	Real Number	g's	•	•
Device Variables	Sensor Bias 1	Real Number	V		•
	Sensor Bias 2	Real Number	V		•
	Supply Voltage	Real Number	V		•
	Ambient Temperature	Real Number	°C		•
Other	Status Bits (including Device_Malfunction)	Bit (i.e. 0 or 1)	None	•	•

3.1.8 Update rate

The default update rate is 60 minutes. This is the maximum (fastest) recommended update rate. You can change this at commissioning or at any time through AMS Device Manager, a Field Communicator, or the Smart Wireless gateway web server. You can set the update rate from 1 minute to 1 hour.

Note

If the device uses a power module, and is configured to publish at the fastest allowable update rate (once per minute), the power module is expected to last only about 2-3 months.

For faster update rates, if your application allows it, use an external DC power option.

3.1.9 Minimize power consumption

The primary way to minimize power consumption is to reduce the publish rate.

Two other configuration settings that affect power consumption are:

- LCD (Liquid Crystal Display)
- PowerSave mode

LCD

Disable the LCD after installation is complete if it is not required during normal operation. It is neither necessary nor sufficient to physically remove the LCD; it must be disabled through configuration in order to save power. From AMS Device Manager, select the wireless network where the transmitter is connected, right-click the transmitter and select **Configure** → **Manual Setup** → **General Settings tab** → **LCD Mode** → **Off**.

Note

Disabling the LCD (not removing it, just disabling it) through configuration provides power savings of about 15–20%.

Leave the LCD installed even if it is disabled to provide valuable diagnostic information. When in a safe location, you can view the LCD by removing the front cover and pressing the **DIAG** button. This wakes the device and displays current information. This can be beneficial for taking a quick reading and to aid in troubleshooting.

⚠ WARNING

Do not remove the front electronics end cap or LCD cover while the device is in a hazardous area.

Removing the cap while the device is in a hazardous area could cause an explosion which could result in death or serious injury.

⚠ CAUTION

The front electronics end cap or LCD cover is certified for hazardous areas in appropriate gas environments (check the nameplate on the device for details).

Exposing the electronics to a production environment may allow particulates, moisture, and other airborne chemicals to enter into the device, which could lead to contamination and potential product performance issues. In all cases, whenever opening the front end cap, be sure to seal it completely afterwards by tightening until the black O-ring is no longer visible. For an illustration on how to properly seal the end cap, see [Figure 2-23](#).

PowerSave mode

PowerSave mode is available in AMS 9420 devices that are Rev. 3 or later and it enables the device to make measurements less frequently, thereby conserving power. This is ideal when either power module life is more critical than the acquisition rate or when changes in vibration are only expected to occur over extended periods of time.

You can configure the settings for the PowerSave mode in AMS Machinery Manager (MHM Access Control must first be enabled) and in AMS Device Manager. The specific field is referred to as PowerSave Skip Multiplier. It is the number of times the transmitter skips data acquisitions between updates to the gateway.

At any point, the effective acquisition rate for the AMS 9420 is defined as:

Effective Acquisition Rate = (Update Rate) x (PowerSave Skip Multiplier)

Valid settings for the PowerSave Skip Multiplier range from 1X to 24X. In order to extend power module life, it should only be combined with a long update rate such as 60 minutes (54 minutes may be optimal for older versions of the AMS 9420). When this value is set to 1X, the AMS 9420 acquires a new reading at the update rate. A PowerSave Skip Multiplier of 2X combined with a 60-minute update rate results in a new acquisition every 120 minutes (every two hours). Similarly, a PowerSave Skip Multiplier of 24X with a 60-minute update rate results in a new acquisition every 1440 minutes (once per day).

3.1.10 Trend parameters

You can trend parameters in multiple locations such as in a plant historian or in AMS Machinery Manager. The method for configuring this functionality is contained in the associated software and the details of all the possibilities are beyond the scope of this

manual. This manual only indicates some of the general capabilities and version requirements.

You can trend values in essentially any host that accepts Modbus or OPC inputs. Configure OPC tags and Modbus registers for wireless devices in the Smart Wireless Gateway web interface. Refer to the Smart Wireless Gateway User Manual for additional information. The settings in the gateway and the host must be consistent and entered in both locations (for example, Modbus register definitions).

DeltaV integrates native wireless I/O devices on the control network. Refer to the DeltaV documentation for more information on the required version. You can manage wireless devices as native HART devices, and trend variables accordingly. This type of installation also allows richer alerting and diagnostics because the full HART capabilities are available.

Ovation 3.3 or later also integrates the Smart Wireless Gateway with all the associated benefits of HART.

AMS Machinery Manager 5.4 or later supports HART functionality to read configuration and alert information, as well as the dynamic parameters from the AMS 9420. This allows AMS Machinery Manager to auto-discover all of the devices on the wireless mesh as well as the specific sensor configurations, units settings, and variable mappings for AMS 9420 devices.

Also, with AMS Machinery Manager and AMS 9420 devices (that are licensed for the Advanced Diagnostics application), you can trend Energy Band parameters and collect spectrum and waveform information. For more information, see [Advanced Diagnostics application](#).

DeltaV versions prior to 10.3 and Ovation versions prior to 3.3, though not integrated through HART, accept Modbus values from the wireless devices. DeltaV also accepts OPC values.

3.1.11 Remove the power module

The AMS 9420 is powered whenever the power module is installed. To avoid depleting the power module, remove it when the device is not in use. If you have configured the sensor and network but are not ready to commission the device, remove the power module to extend operating life.

Procedure

1. Disconnect the communication leads.
2. Remove the power module.
3. Replace the transmitter cover.

3.2 Configuration with a Field Communicator

You can configure the AMS 9420 using a 475 Field Communicator. Follow the connection diagram in [Figure 3-2](#). For instructions on using the AMS Trex™ Device Communicator, refer to the AMS Trex Device Communicator User Guide.

A Rev 4 DD is recommended when using a 475 Field Communicator to configure the AMS 9420. The DD for the AMS 9420 is located on the DVD that came with the transmitter. Refer to the Field Communicator User's Manual for more details on DDs or go to <http://>

www.emerson.com/en-us/catalog/ams-475-field-communicator for instructions on adding a DD for AMS 9420.

The AMS 9420 requires 475 Field Communicator System Software version 3.2 or later.

3.2.1 Field Communicator menu trees

[Figure 3-4](#) through [Figure 3-15](#) show the 475 Field Communicator configuration menu trees for AMS 9420 using a Rev 4 DD. For ease of operation, you can access some common tasks in several locations of the menu structure.

Figure 3-4: Field Communicator menu tree for AMS 9420, one accelerometer: 1 of 4

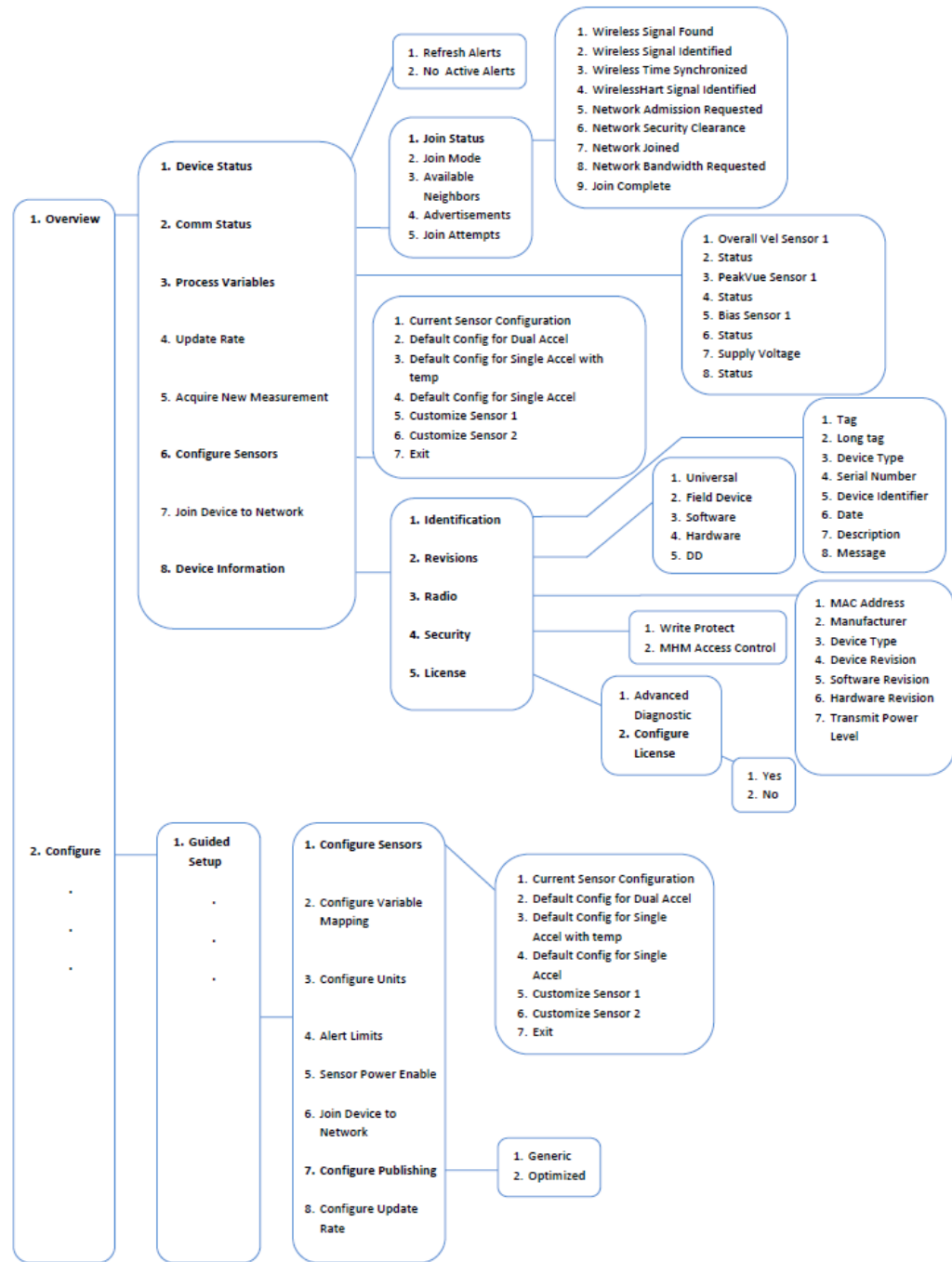

Figure 3-5: Field Communicator menu tree for AMS 9420, one accelerometer: 2 of 4

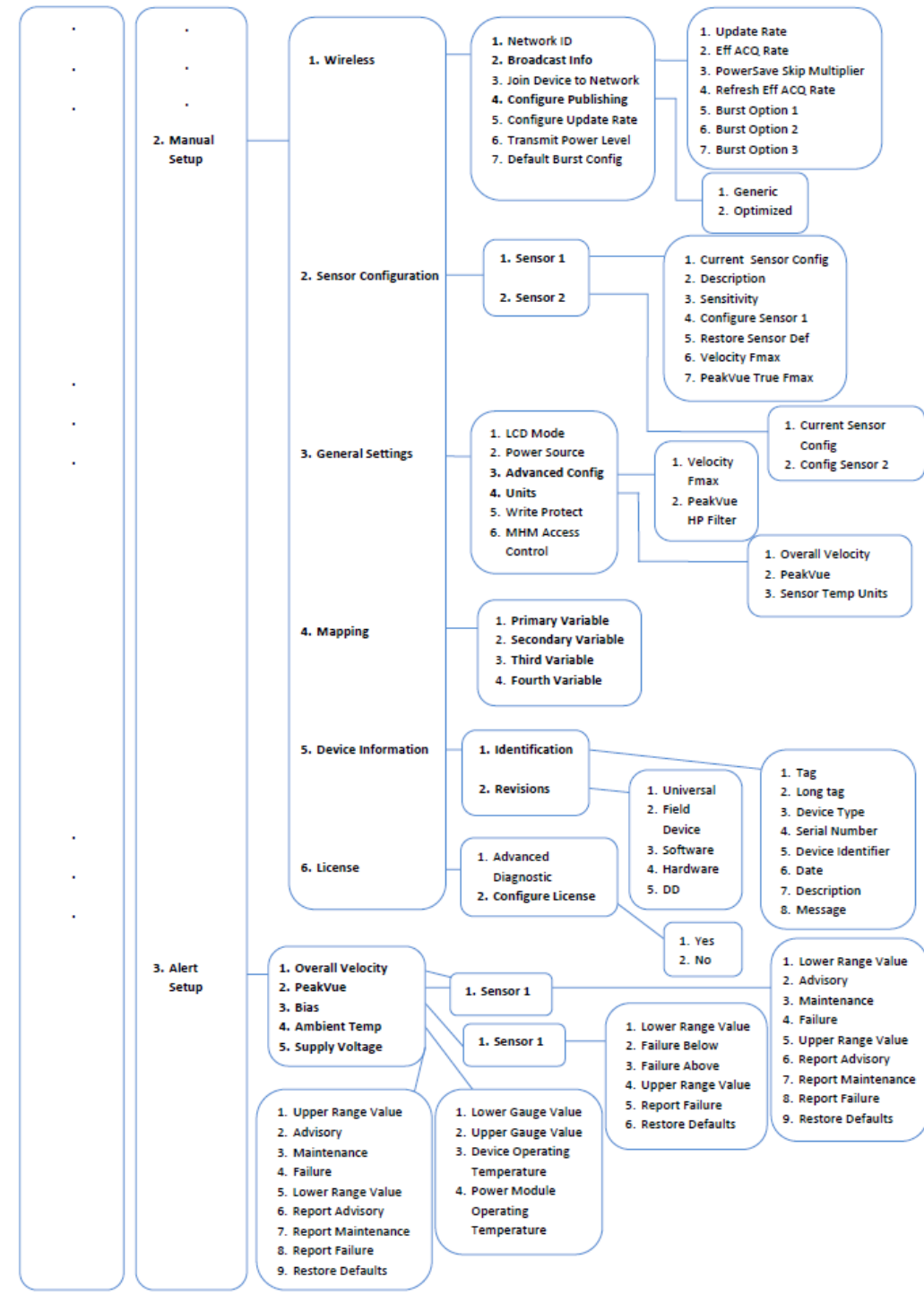
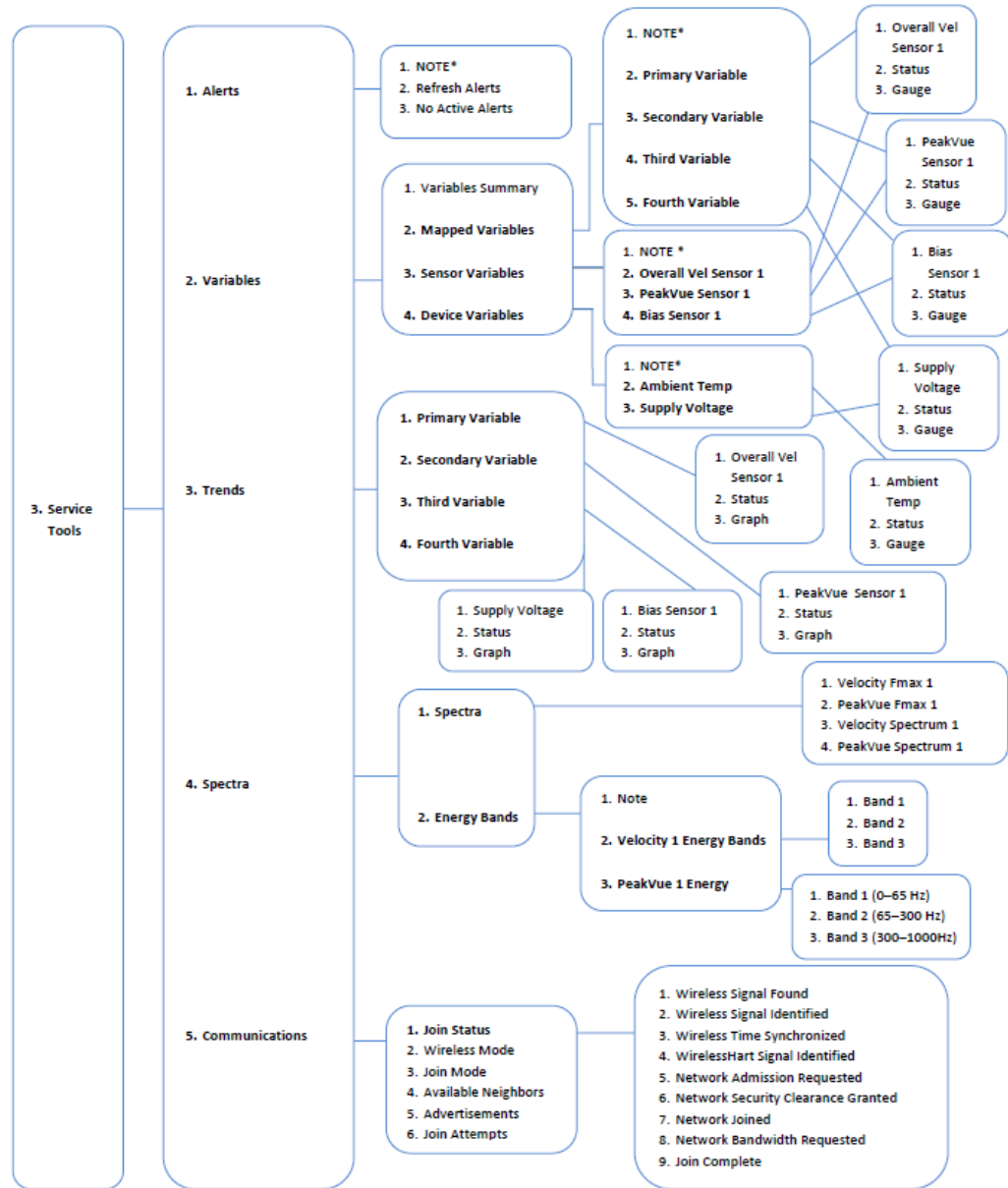

Figure 3-6: Field Communicator menu tree for AMS 9420, one accelerometer: 3 of 4



*This is only displayed when the device is configured to use the optimized burst mode.

Figure 3-7: Field Communicator menu tree for AMS 9420, one accelerometer: 4 of 4

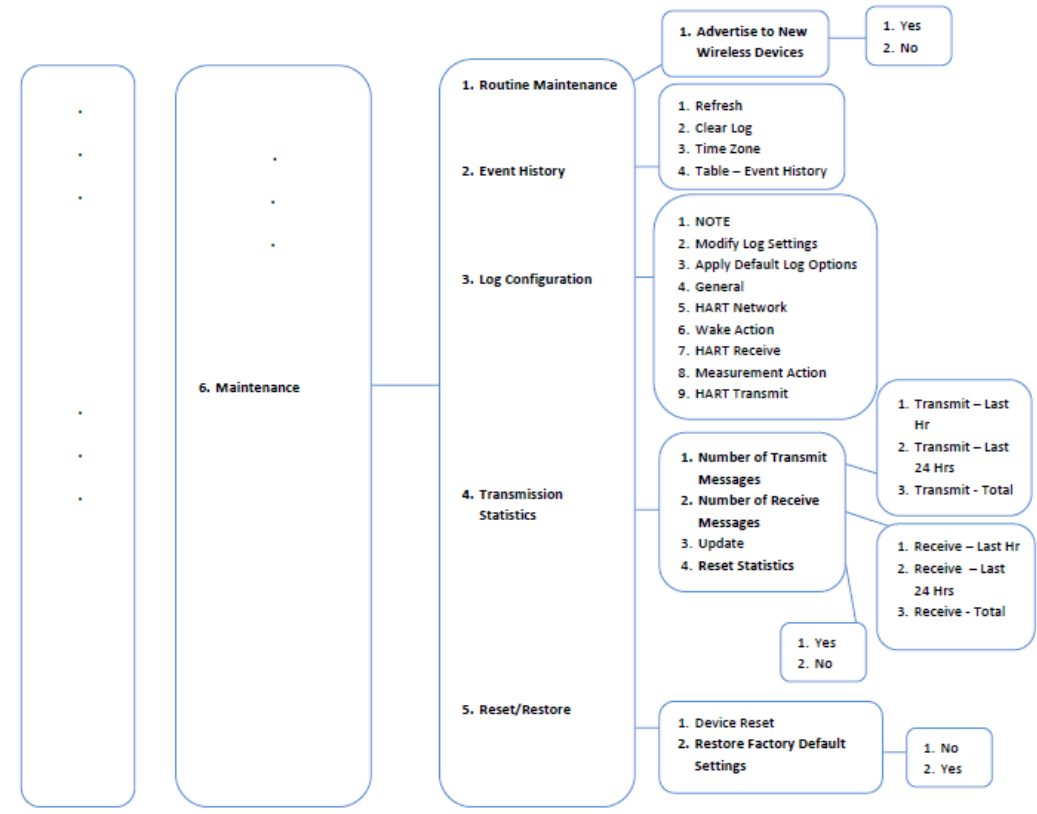

Figure 3-8: Field Communicator menu tree for AMS 9420, one accelerometer with temperature: 1 of 4

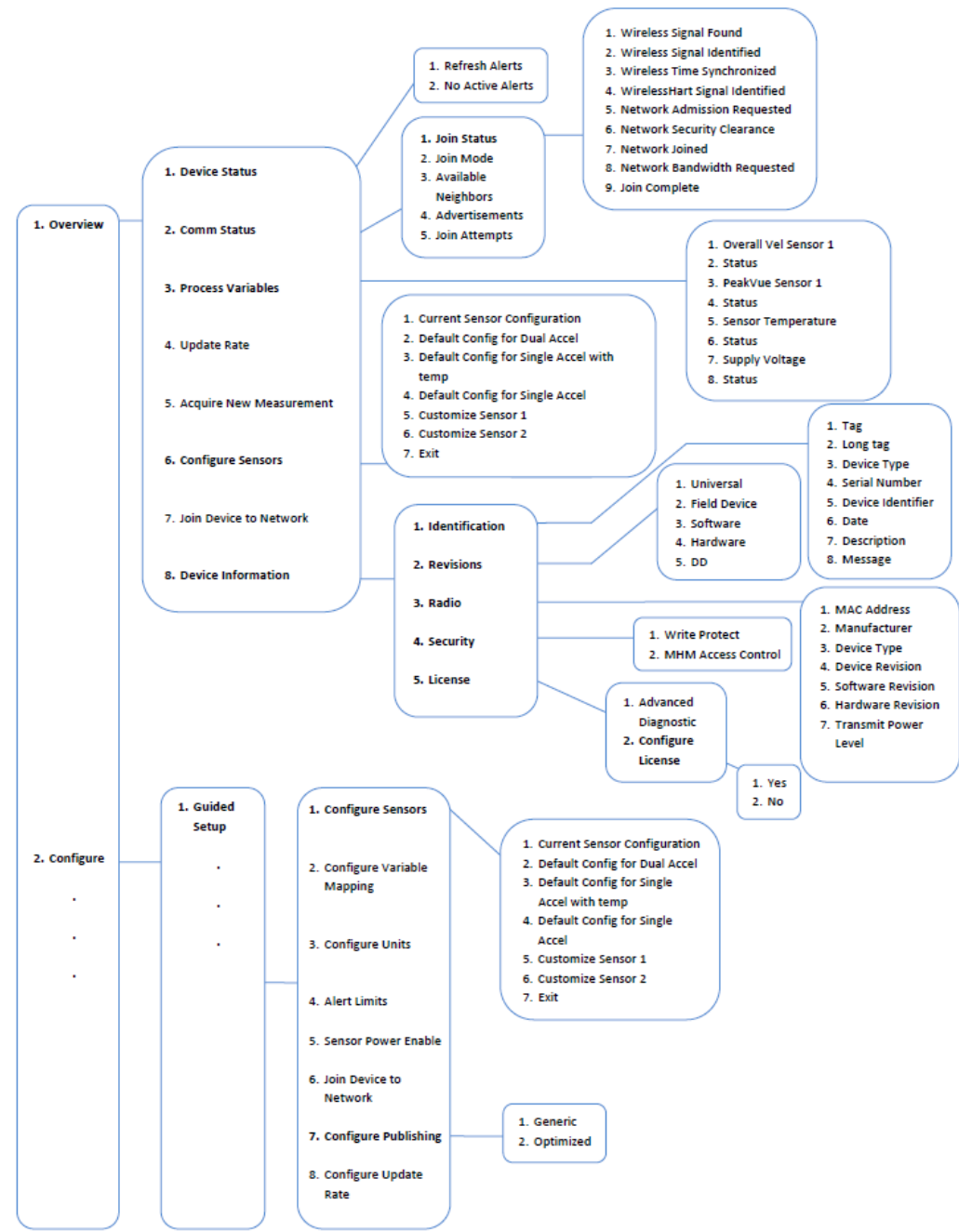

Figure 3-9: Field Communicator menu tree for AMS 9420, one accelerometer with temperature: 2 of 4

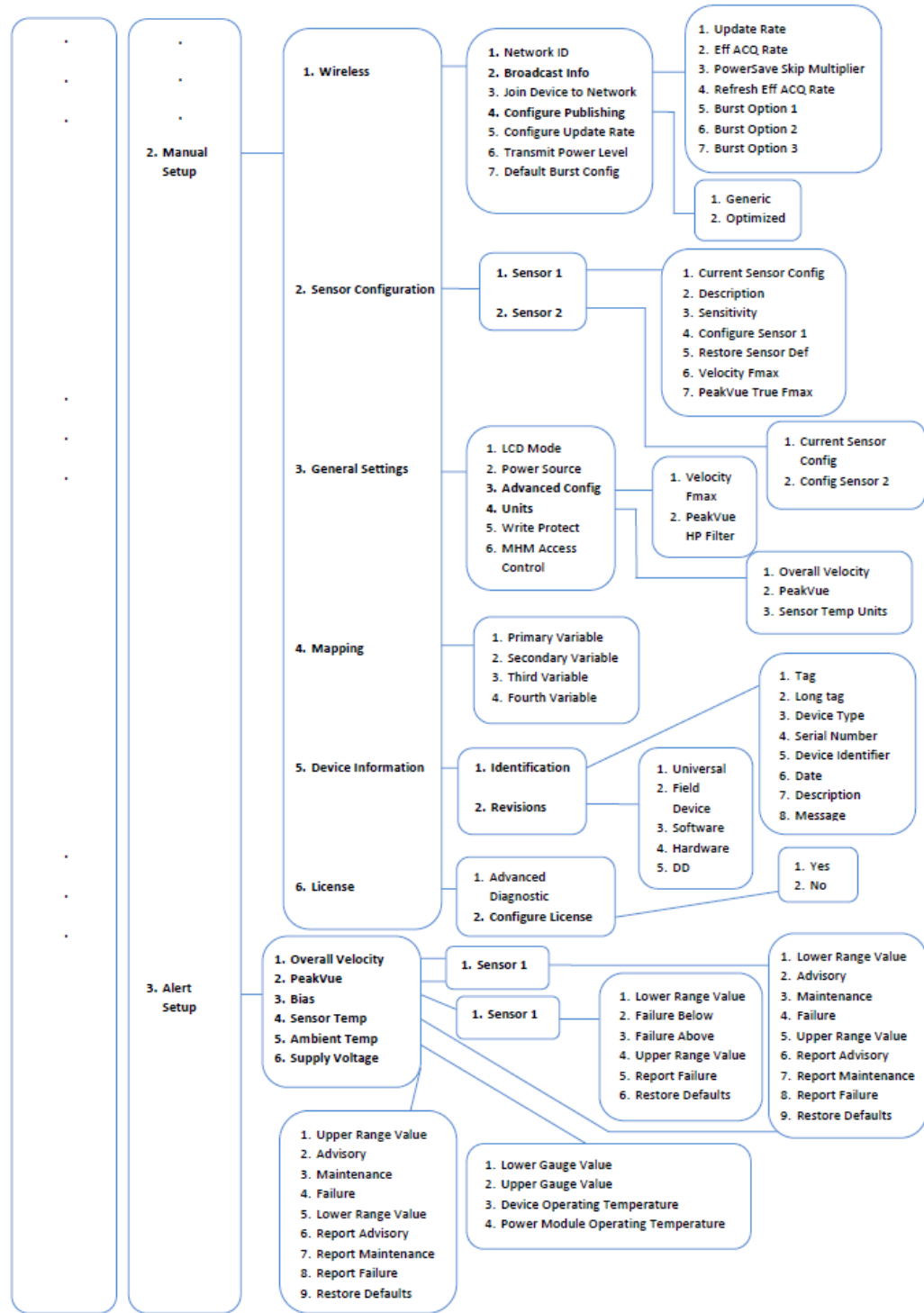
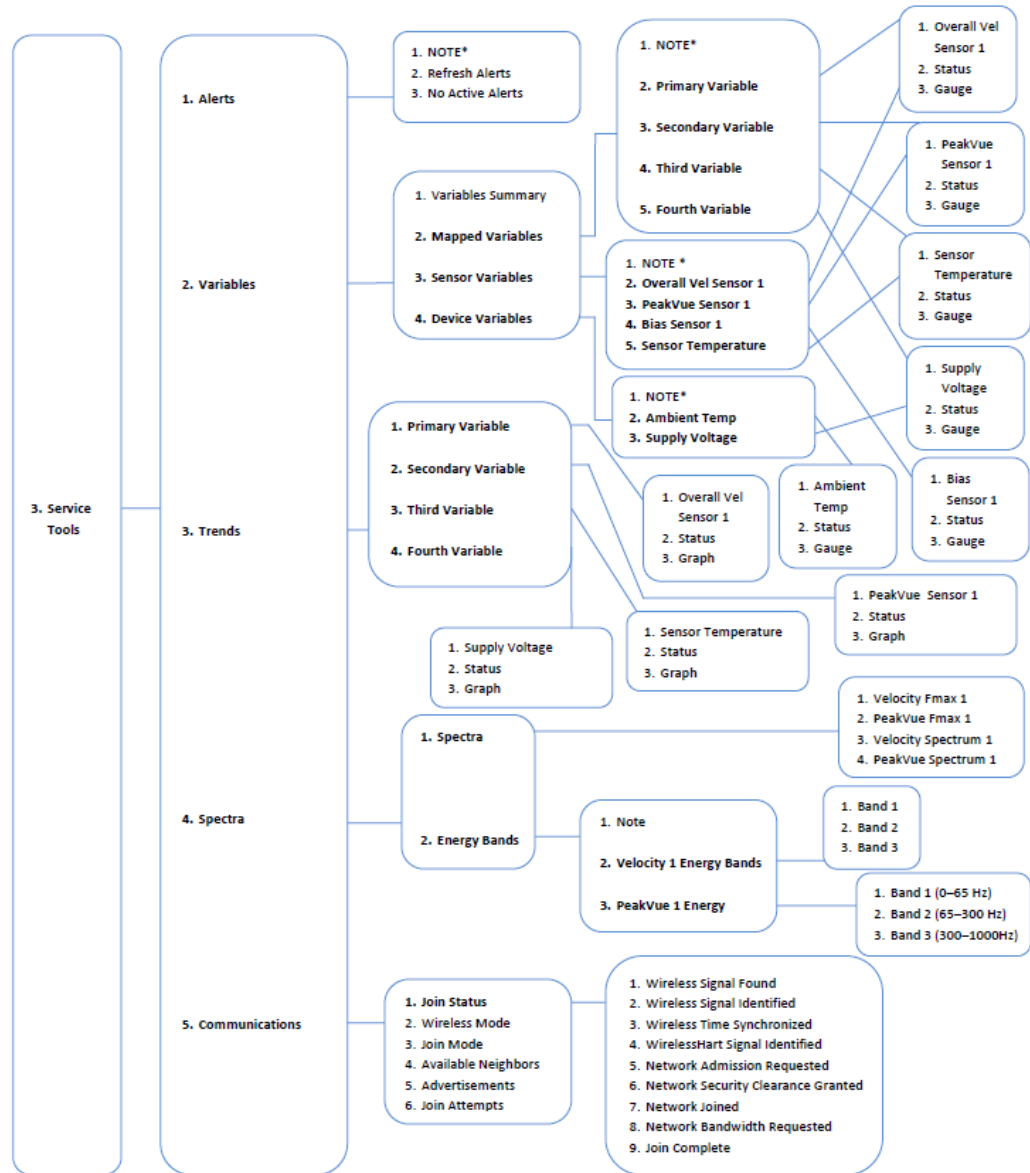

Figure 3-10: Field Communicator menu tree for AMS 9420, one accelerometer with temperature: 3 of 4



**This is only displayed when the device is configured to use the optimized burst mode.*

Figure 3-11: Field Communicator menu tree for AMS 9420, one accelerometer with temperature: 4 of 4

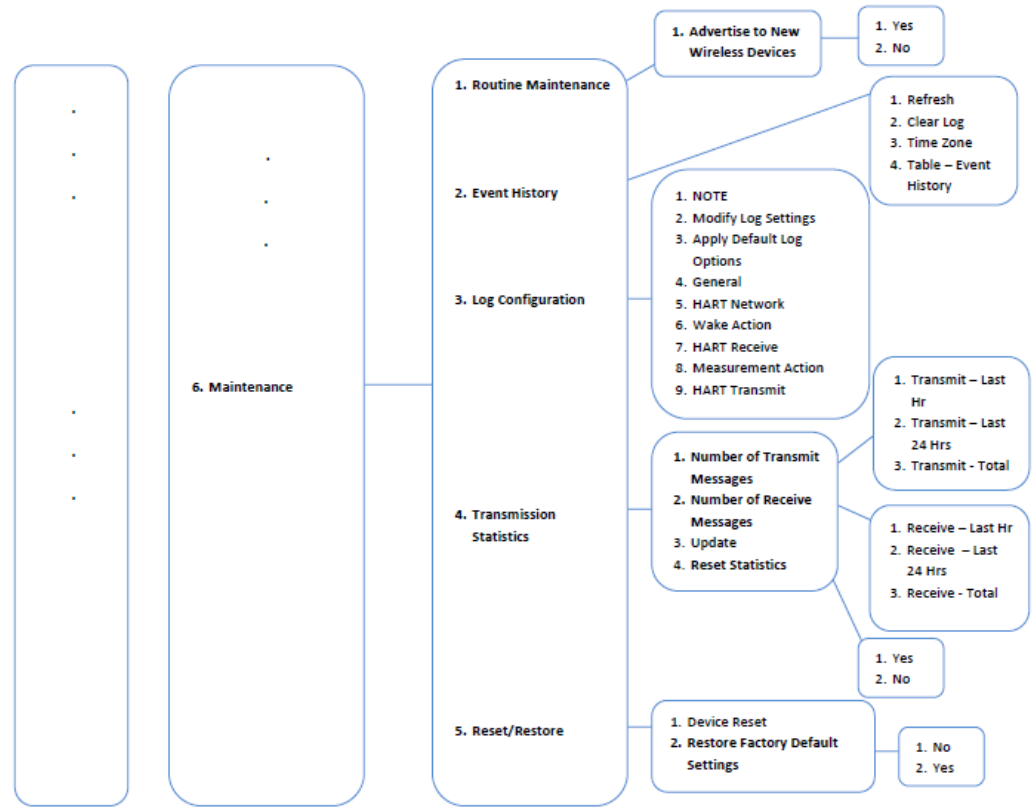

Figure 3-12: Field Communicator menu tree for AMS 9420, two accelerometers: 1 of 4

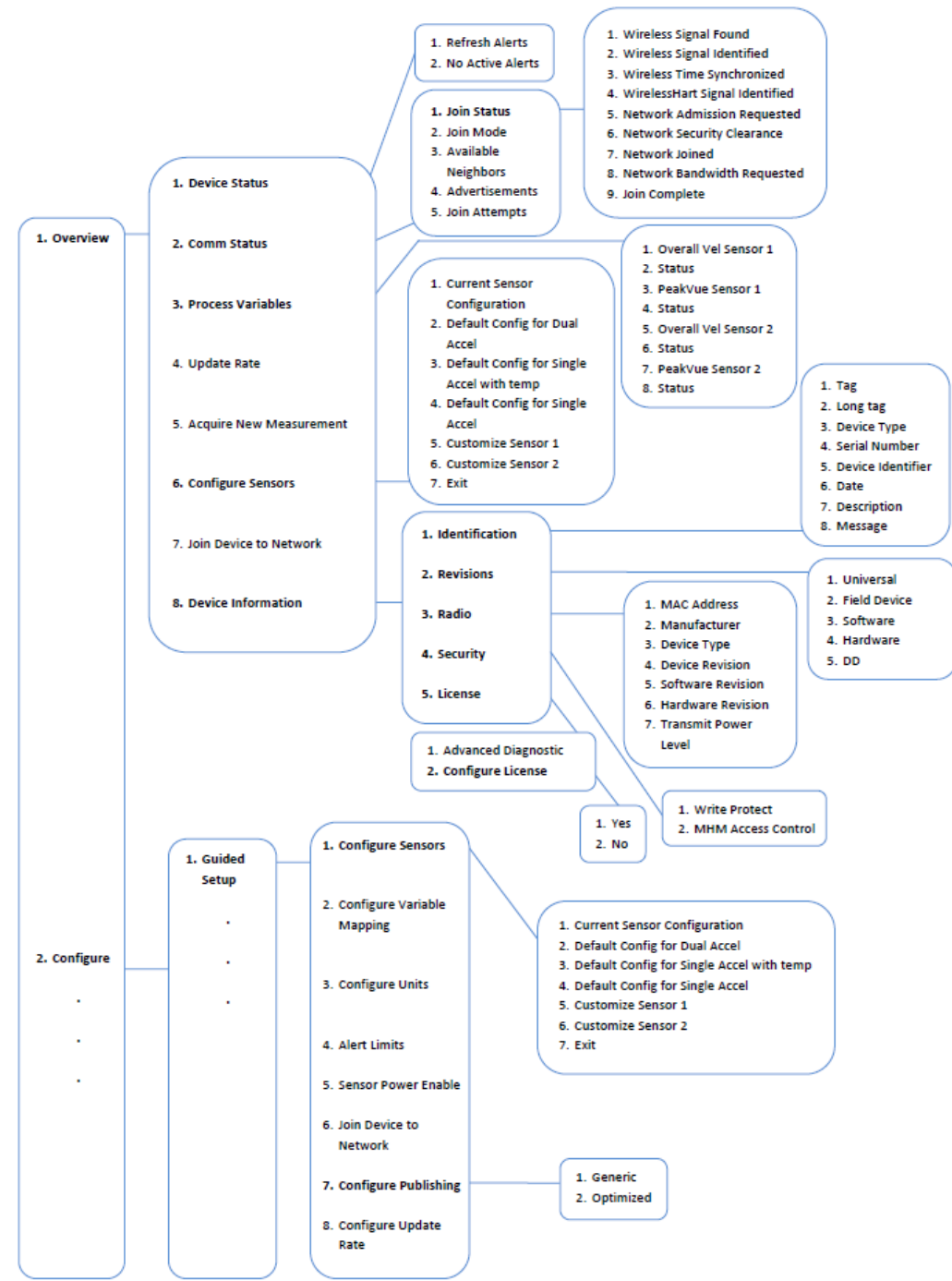

Figure 3-13: Field Communicator menu tree for AMS 9420, two accelerometers: 2 of 4

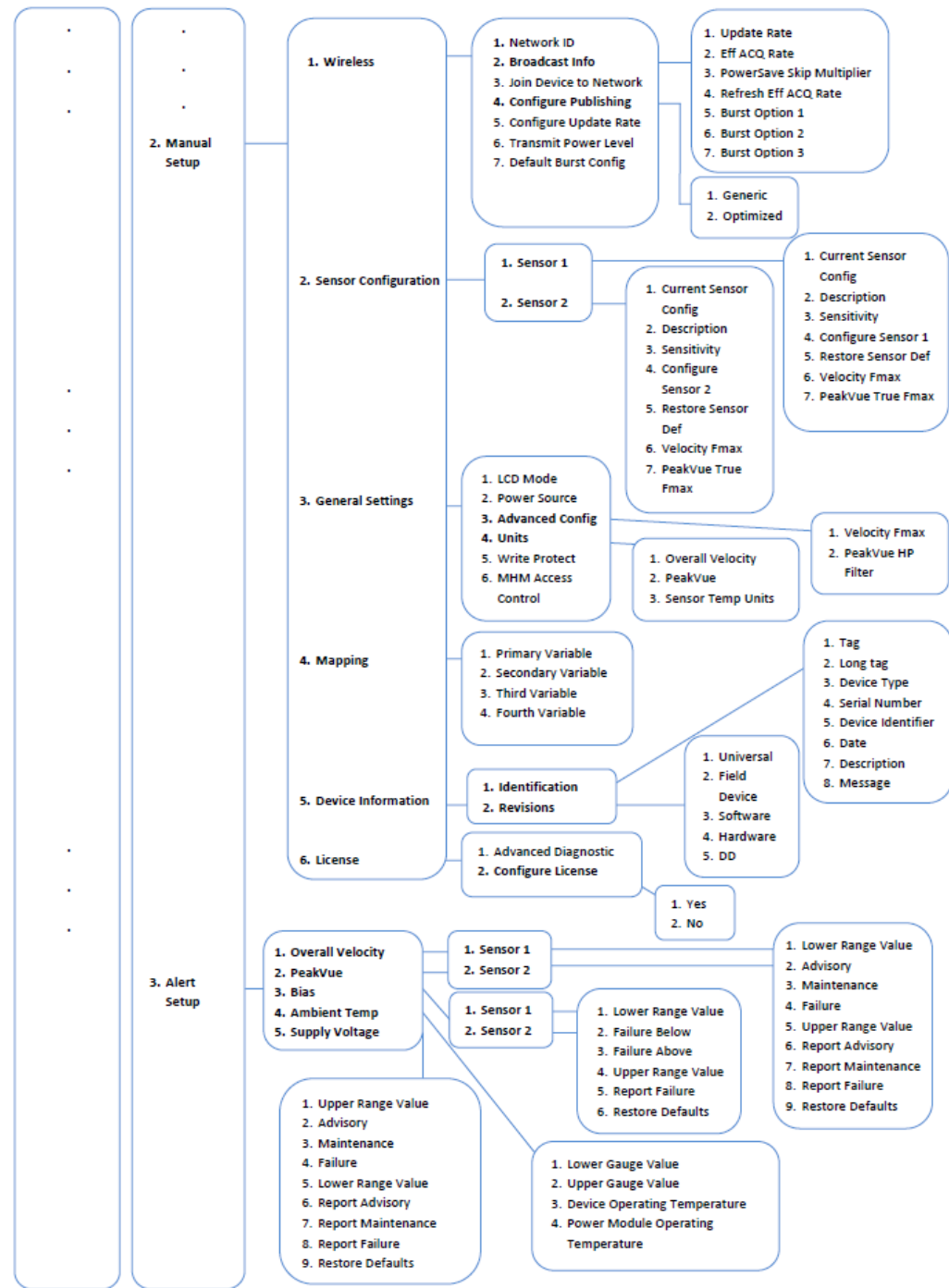
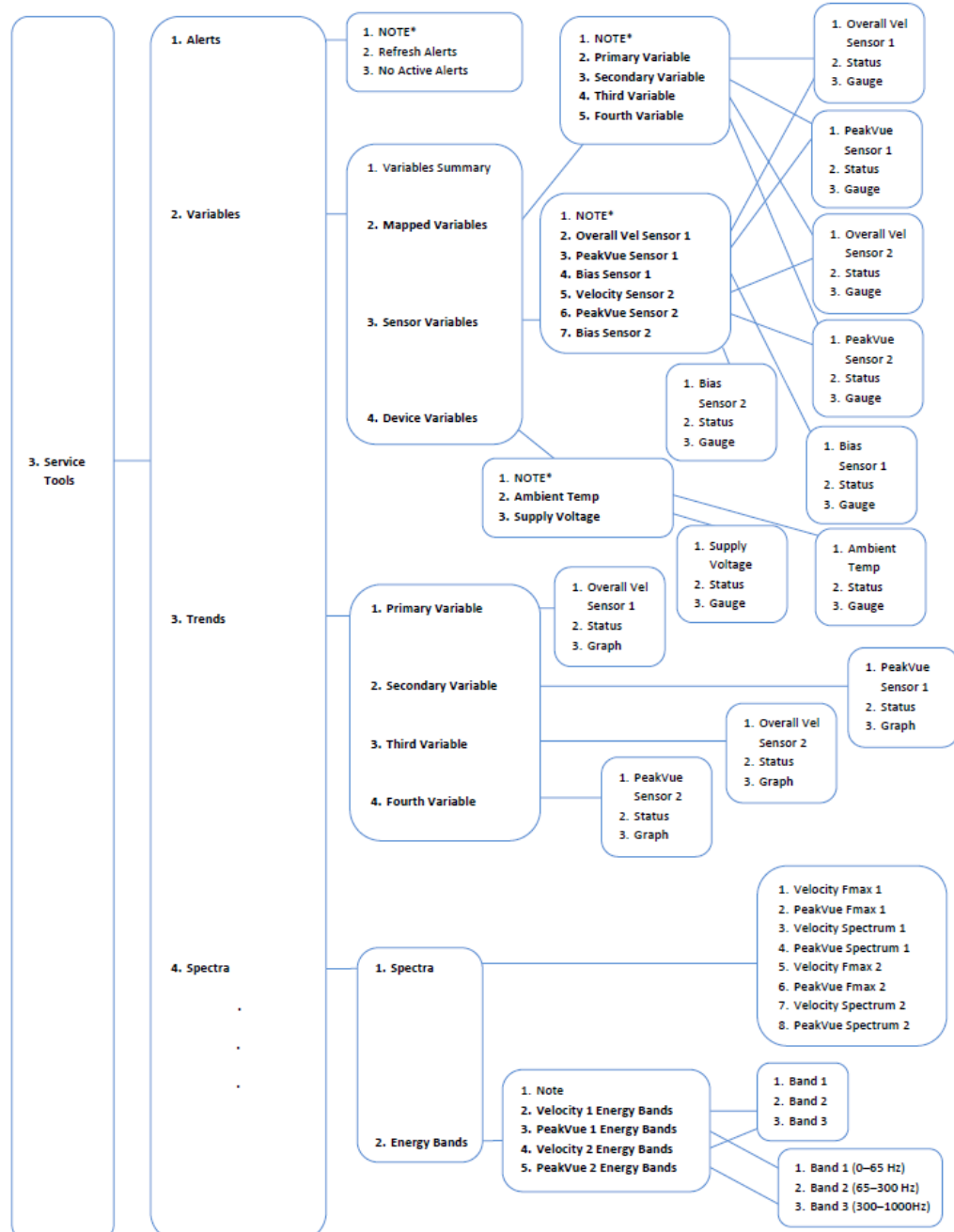
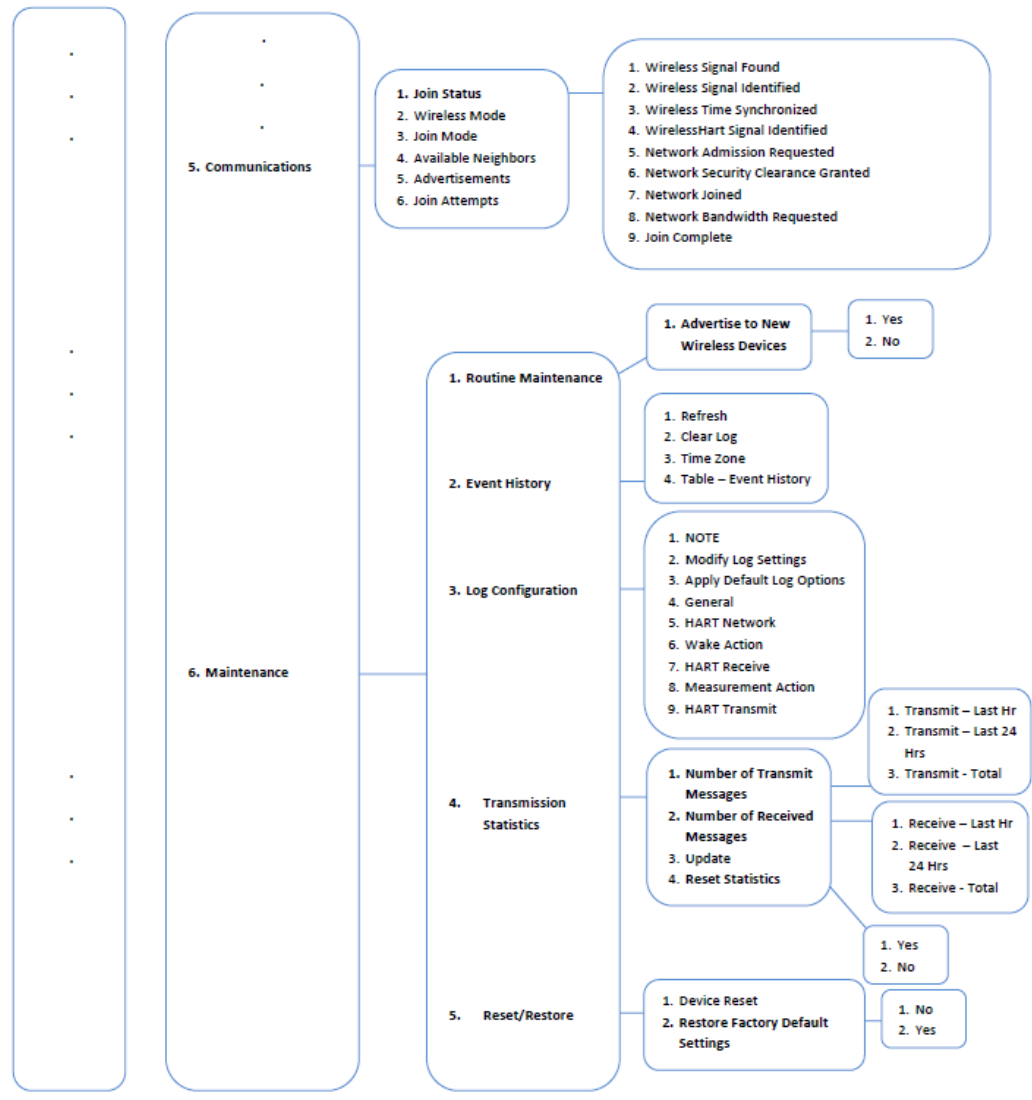

Figure 3-14: Field Communicator menu tree for AMS 9420, two accelerometers: 3 of 4



*This is only displayed when the device is configured to use the optimized burst mode.

Figure 3-15: Field Communicator menu tree for AMS 9420, two accelerometers: 4 of 4



3.2.2 Field Communicator fast key sequences

Note

The following fast key sequences assume that you are using the 475 Field Communicator with a Rev 4 DD. Press **Send** to save the changes to the device.

Table 3-8: AMS 9420 network configuration

Key sequence	Menu items
2, 2, 1 (Manual Setup)	Network ID Broadcast Info Join Device to Network Configure Publishing Configure Update Rate Transmit Power Level Default Burst Config
2, 1 (Guided Setup)	Configure Sensors Configure Variable Mapping Configure Units Alert Limits Sensor Power Enable Join Device to Network Configure Publishing Configure Update Rate

Table 3-9: AMS 9420 common fast key sequences

Function	Key sequence	Menu items
General settings	2, 2, 3 (Manual Setup)	LCD Mode Power Source Advanced Config Units Write Protect MHM Access Control
Alert setup	2, 3	Overall Velocity PeakVue Bias Ambient Temperature Supply Voltage
Update rate	2, 1, 8 (Guided Setup) 2, 2, 1, 5 (Manual Setup)	Configure Update Rate
Publishing mode	2, 1, 7 (Guided Setup) 2, 2, 1, 4 (Manual Setup)	Configure Publishing
Write protect	2, 2, 3, 5 (Manual Setup)	Write Protect

Table 3-9: AMS 9420 common fast key sequences (continued)

Function	Key sequence	Menu items
Power options	2, 2, 3, 2 (Manual Setup)	Power Source
MHM Access Control	2, 2, 3, 6 (Manual Setup)	MHM Access Control
Supply power to sensor	2, 1, 5 (Guided Setup)	Sensor Power Enable
Configure variable mapping	2, 1, 2 (Guided Setup)	Configure Variable Mapping
Device reset	3, 6, 5	Device Reset Restore Factory Default Settings

3.3 Configuration with AMS Device Manager

3.3.1 Configure wireless network credentials in AMS Device Manager

Prerequisites

Before performing operations in AMS Device Manager, first scan the AMS 9420 with a wired HART modem. Right-click the HART Modem icon  in Device Explorer and select **Scan All Devices**.

Note

Configuring the wireless network is only applicable using a wired HART modem and cannot be done using WirelessHART devices.

Procedure

1. Right-click the AMS 9420 device and select **Methods** → **Join Network**.
2. Enter the network ID for the wireless network in the Join Device to Network screen and click **Next**.

You can obtain the network ID from the Smart Wireless Gateway web server. Click **Setup** → **Network** → **Settings**.
3. Enter the Join Key in the screens that follow, and click **Next**.
4. Select the **Accept new join key** option, and click **Next**.
5. Click **Finish** when done.

3.3.2 Right-click menu

The right-click menu of the AMS 9420 device in AMS Device Manager provides a quick link to the Configure, Compare, Service Tools, and Overview windows, as well as to other context menus available for the device. This document only discusses the Overview, Configure, and Service Tools windows; for more information on the other context menus, refer to AMS Device Manager Books Online.

In the Device Explorer view, select the wireless network where the transmitter is connected and right-click the transmitter to display the context menus.

Figure 3-16: AMS 9420 right-click menu

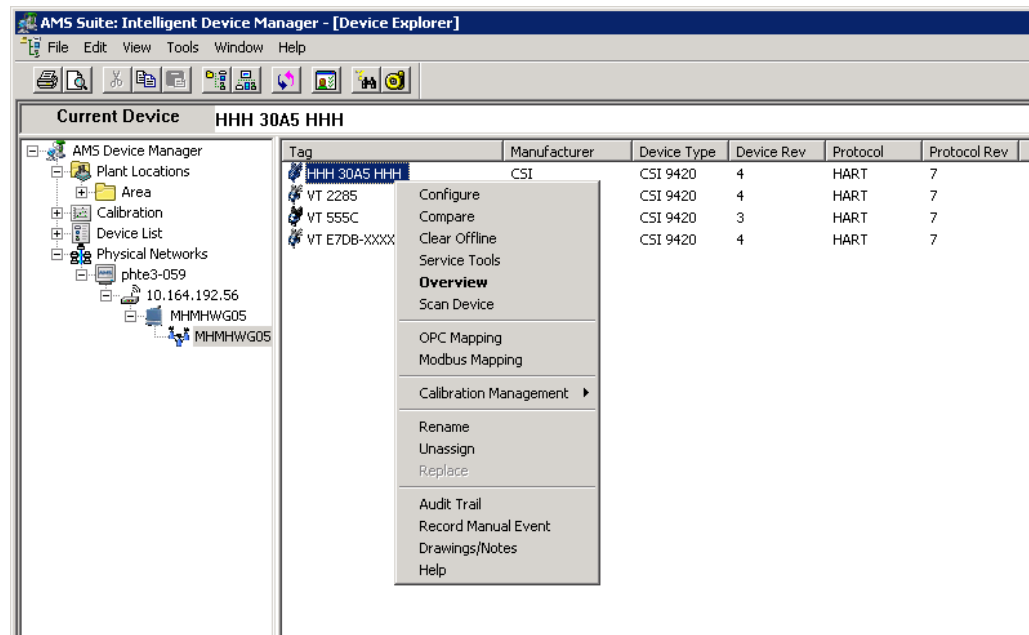

Overview

Figure 3-17: Overview window

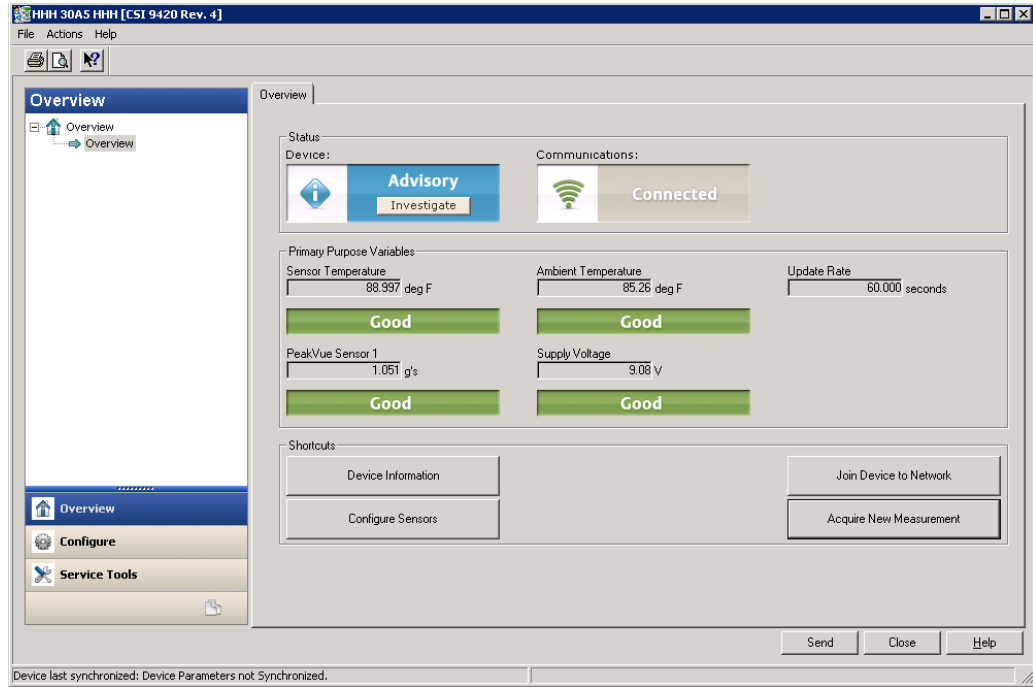

The Overview window provides a glimpse of the status of the CSI 9420, including the primary purpose variables associated with it.

You can also access the following shortcuts from this page:

- Device Information
- Configure Sensors
- Join Device to Network
- Acquire New Measurement

Device Information

From the Overview window, click **Device Information** to display relevant device information.

Figure 3-18: Device Information window

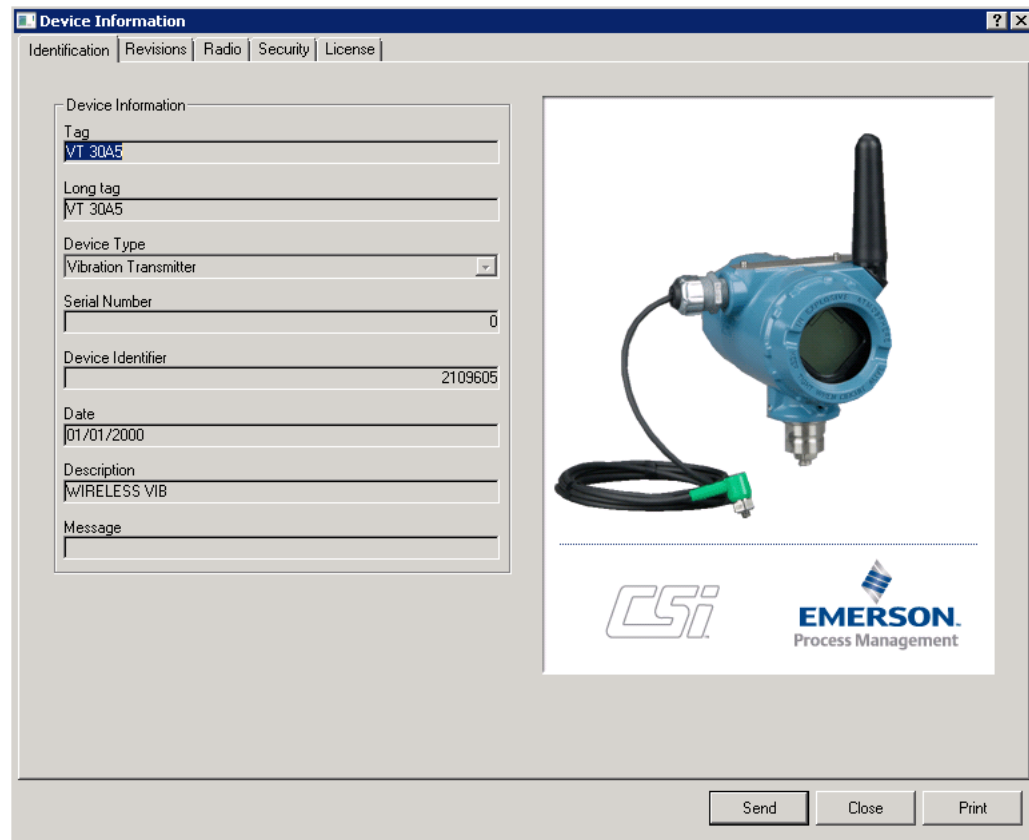

Click the **Identification tab** to display the device tag, long tag, device type, serial number, identifier, and description.

Click the **Revisions tab** to display the universal, field device, software, hardware, and DD revision numbers.

Click the **Radio tab** to display the device MAC address, manufacturer, device type, revision numbers, and transmit power level.

Click the **Security tab** to display Write Protect information and to view whether MHM Access Control is enabled.

Click the **License tab** to display installed licensable features such as the Advanced Diagnostics application.

Click **License tab** → **Configure License** to configure/change installed licenses.

Configure Sensors

From the Overview window, click **Configure Sensors** to display installed sensors and current sensor configurations.

Figure 3-19: Sensor Configuration window

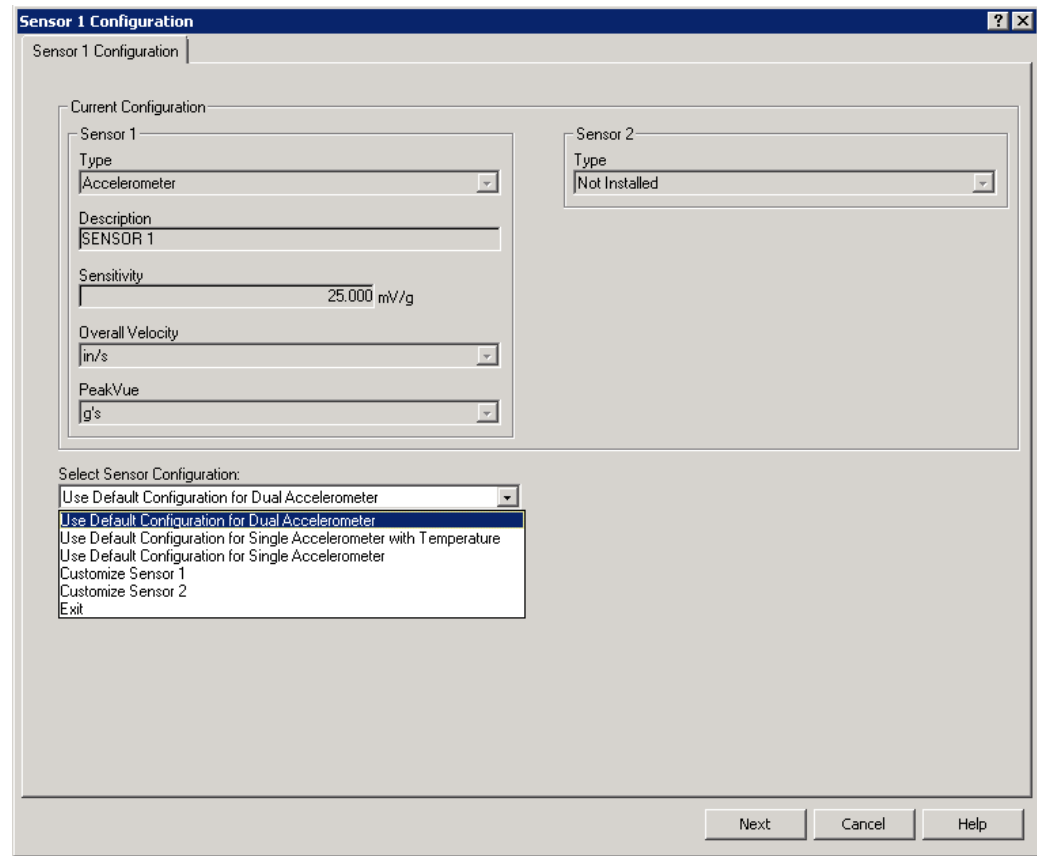

Click the **Select Sensor Configuration** drop-down to select a sensor configuration to apply to the installed sensors.

Join Device to Network

From the Overview window, click **Join Device to Network** to enter network identifiers and join keys that will enable the transmitter to join a wireless network.

Figure 3-20: Join Device to Network window

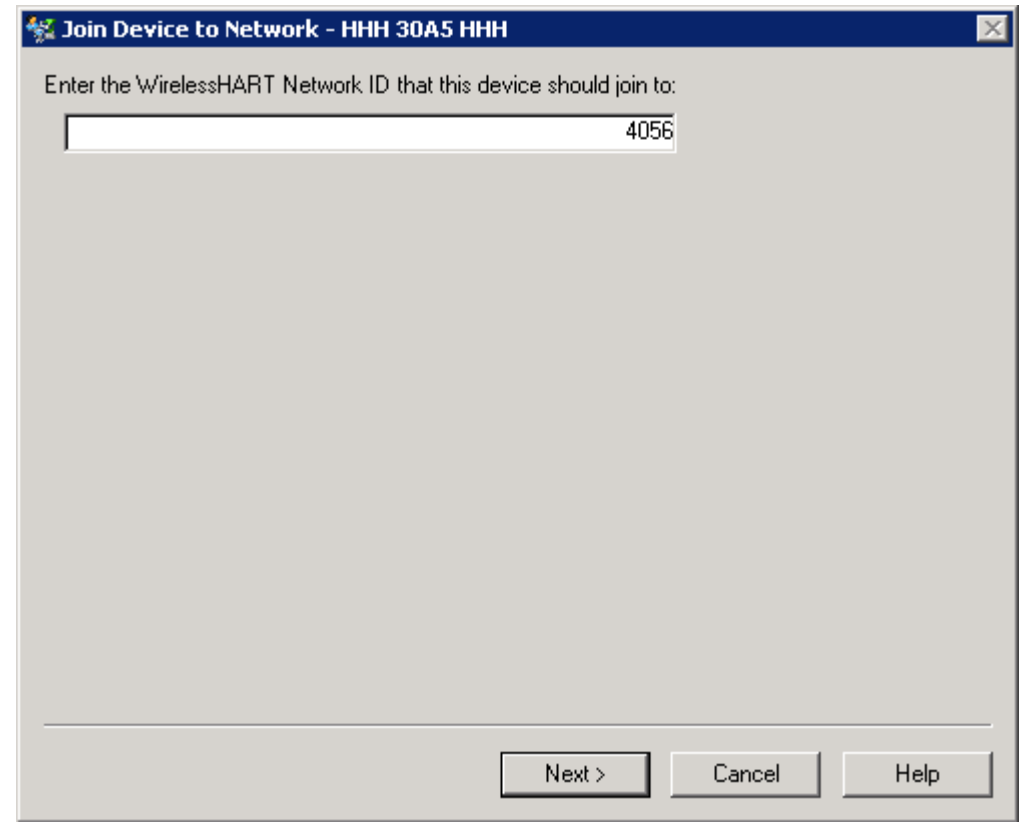

Acquire New Measurement

From the Overview window, click **Acquire New Measurement** to display measurement statistics for Velocity, PeakVue, bias, and sensor temperature for installed sensors. This also displays supply voltage and ambient temperature information for the transmitter.

Figure 3-21: Measurement Statistics window

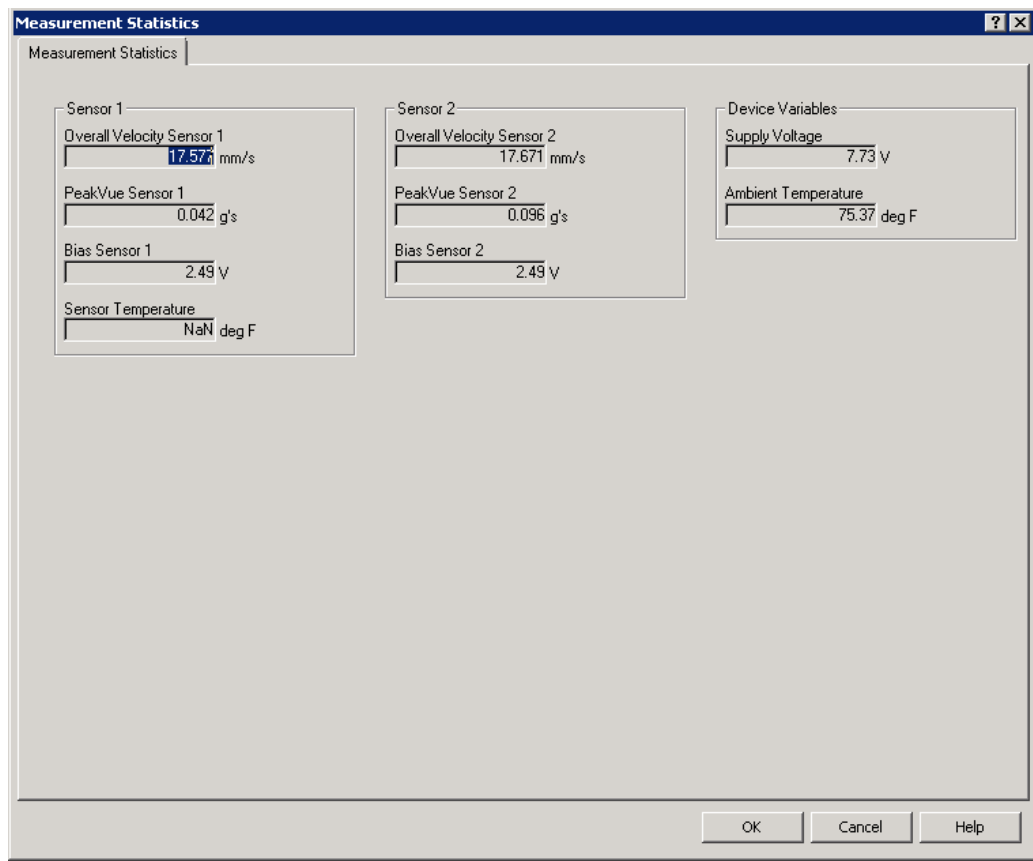

Configure

Figure 3-22: Configure window

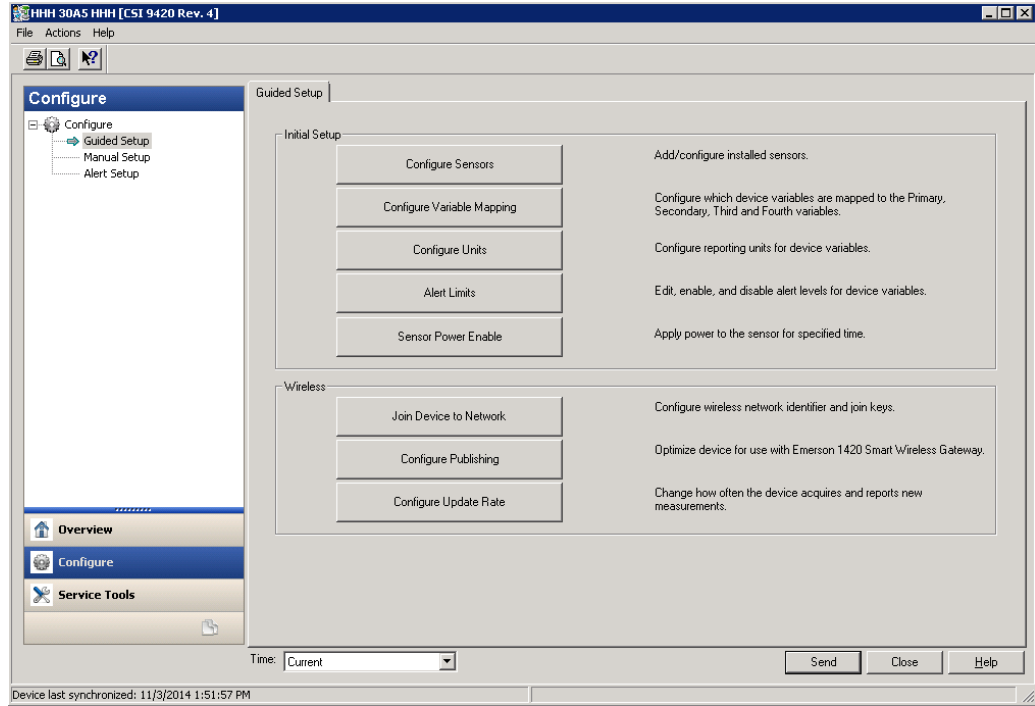

The Configure window lets you configure device settings.

Important

To be able to edit configuration settings, select **Current** in the Time drop-down menu at the bottom of the screen.

Guided Setup

Guided Setup lets you configure device settings in a guided step-by-step process.

Click **Configure Sensors** to display or configure installed sensors.

Click **Configure Variable Mapping** to display or specify which measurements are reported as the Primary, Secondary, Third, and Fourth variables.

Click **Configure Units** to configure units for Overall Velocity, PeakVue, and temperature.

Click **Alert Limits** to define the lower range and upper range values and alert limits for Advisory, Maintenance, and Failure for each of the process variables. You can also configure alert reporting from here.

Click **Sensor Power Enable** to supply power to the sensor for a specific amount of time.

Note

Sensor Power Enable is only available when the device is connected to AMS Device Manager using a USB or serial HART modem and when the device is connected to a Field Communicator. This feature is not available when the device is connected to AMS Device Manager using a WirelessHART connection.

Click **Join Device to Network** to enter network identifiers and join keys that will enable the transmitter to join a wireless network.

Click **Configure Publishing** to set how parameters are published (generic or optimized).

Click **Configure Update Rate** to set how often the device acquires and reports new measurements (update rate) and to specify the number of times the transmitter skips data acquisitions between updates to the gateway (PowerSave Skip Multiplier).

Manual Setup

Manual Setup lets you configure device settings manually.

Click the **Wireless** tab to display wireless network information for the transmitter.

Figure 3-23: Wireless tab

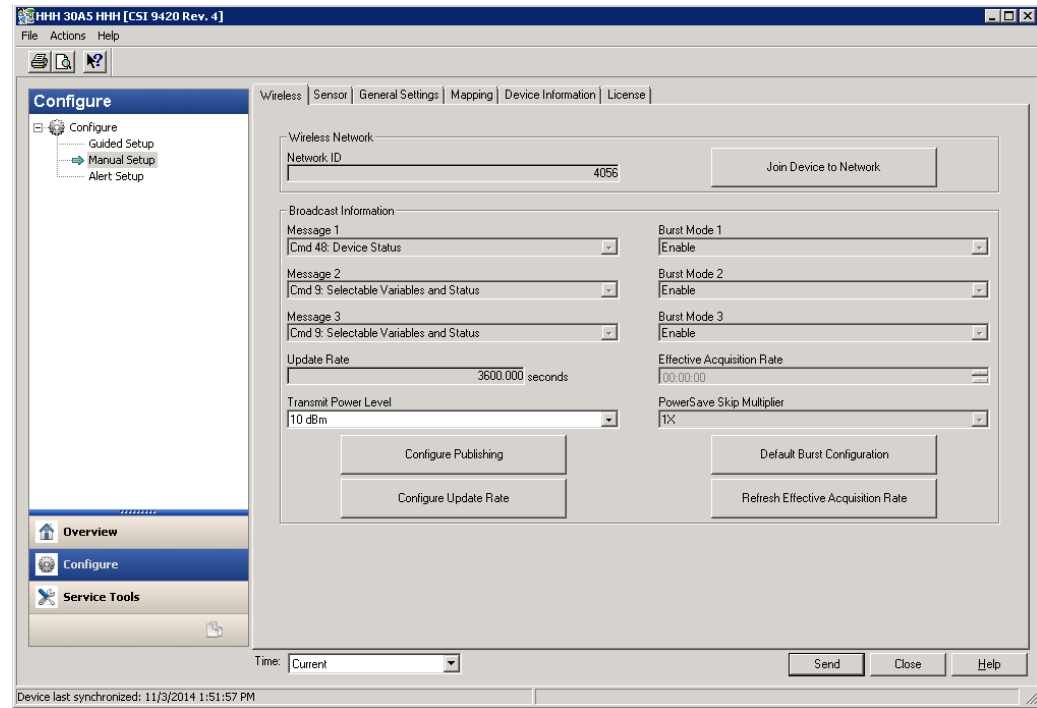

Click **Join Device to Network** to enter network identifiers and join keys that will enable the transmitter to join a wireless network.

Click **Configure Publishing** to set how parameters are published (generic or optimized).

Click **Configure Update Rate** to set how often the device acquires and reports new measurements (update rate) and to specify the number of times the transmitter skips data acquisitions between updates to the gateway (PowerSave Skip Multiplier).

Click **Default Burst Configuration** to reset the burst configuration to default values.

Click **Refresh Effective Acquisition Rate** to refresh the value in the Effective Acquisition Rate field.

Click the **Sensor** tab to display current sensor configurations. You can also edit the sensor sensitivity value from this page.

Figure 3-24: Sensor tab

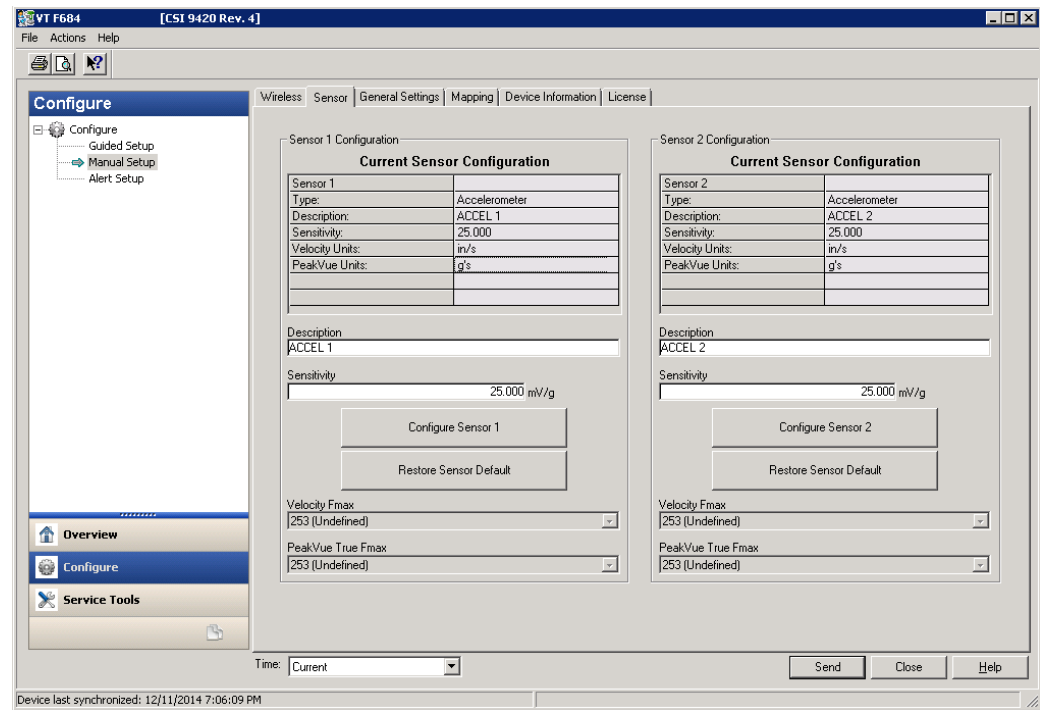

- Click **Configure Sensor x** to configure the parameters for the specific sensor.
- Click **Restore Sensor Default** to reset the sensor parameters to default values.
- Click the **General Settings tab** to display or edit general transmitter settings.

Figure 3-25: General Settings tab

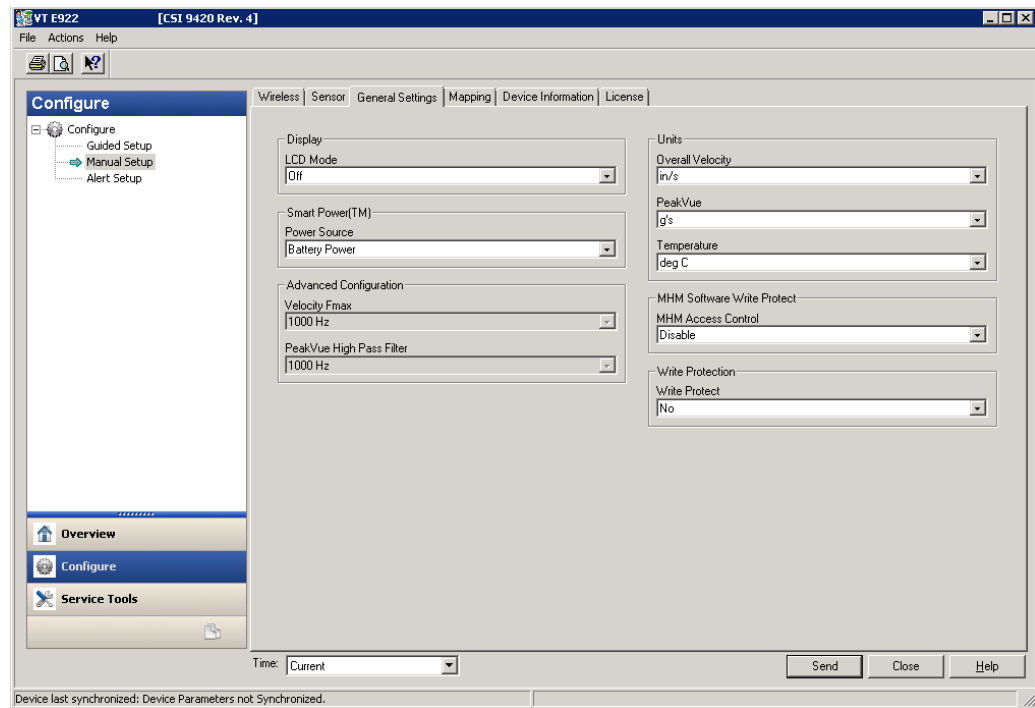

Click the **LCD Mode** drop-down to enable or disable the LCD, or to set it to troubleshooting mode.

Click the **Power Source** drop-down to select the transmitter power source.

Select the units for measurement variables from the **Overall Velocity**, **PeakVue**, and **Temperature** drop-down menus.

Click the **MHM Access Control** drop-down to enable or disable Access Control for AMS Machinery Manager. Access Control allows AMS Machinery Manager to make changes to the AMS 9420 configuration.

⚠ CAUTION

If the device will be commissioned in a HART DCS host (e.g., DeltaV or Ovation), do not enable AMS Machinery Manager to make changes to the configuration.

Click the **Write Protect** drop-down to specify whether variables can be written to the device.

Click the **Mapping tab** to specify which measurements are reported as the Primary, Secondary, Third, and Fourth variables.

Figure 3-26: Mapping tab

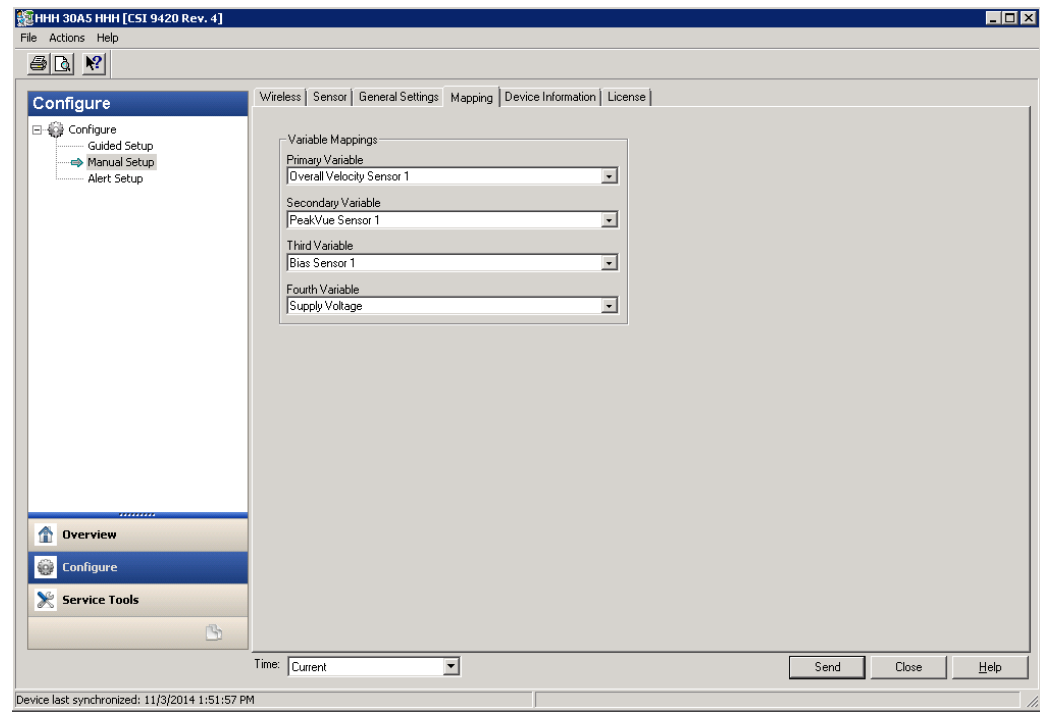

Click the **Device Information** tab to display the device tag, long tag, device type, serial number, device identifier, and description, and to display the universal, field device, software, hardware, and DD revision numbers.

Figure 3-27: Device Information tab

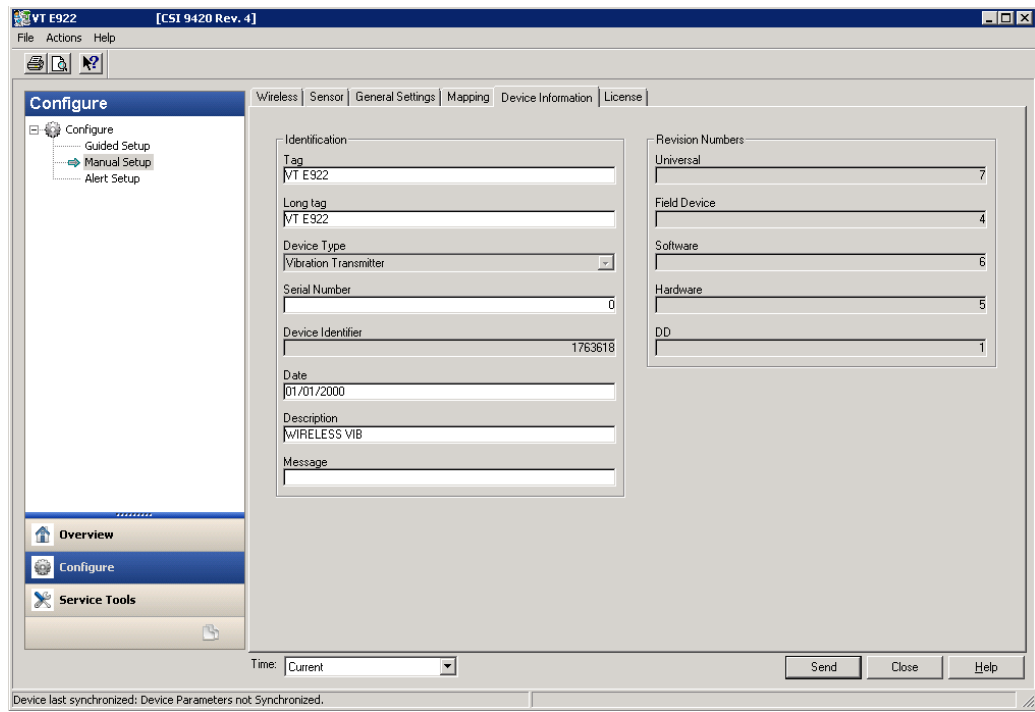

License tab

Click the **License tab** to display installed licensable features such as the Advanced Diagnostics application.

Figure 3-28: License tab

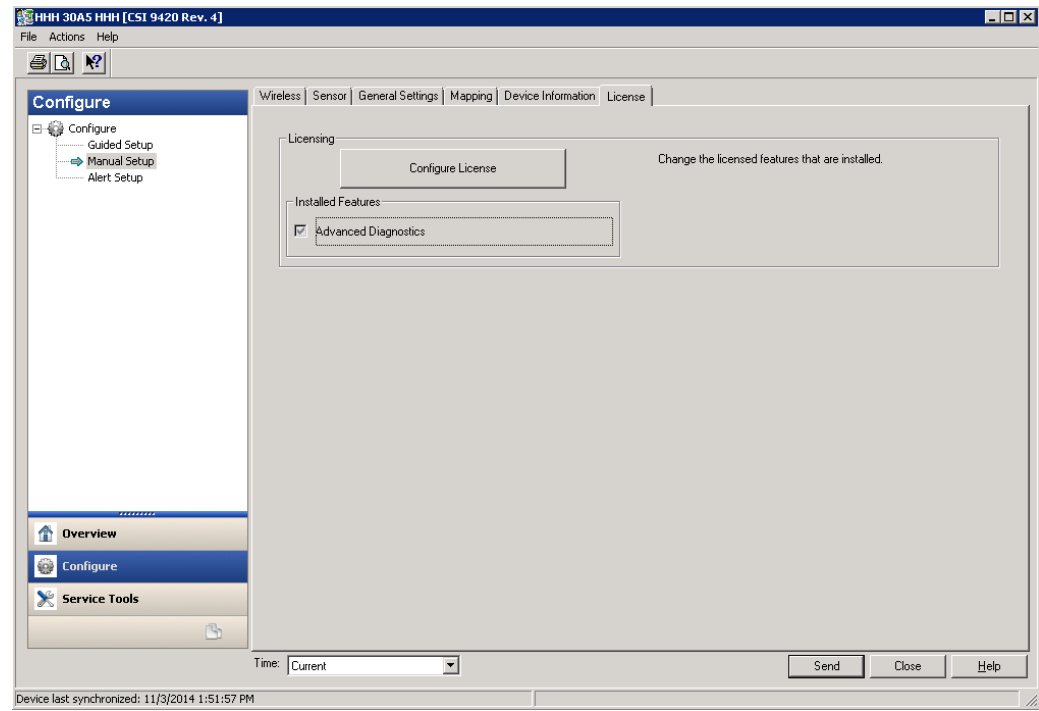

Click **Configure License** to configure/change installed licenses.

Alert Setup

Alert Setup lets you configure the upper and lower range values and alarm limits for Overall Velocity, PeakVue, Bias, Sensor Temperature, Ambient Temperature, and Supply Voltage.

Figure 3-29: Alert Setup

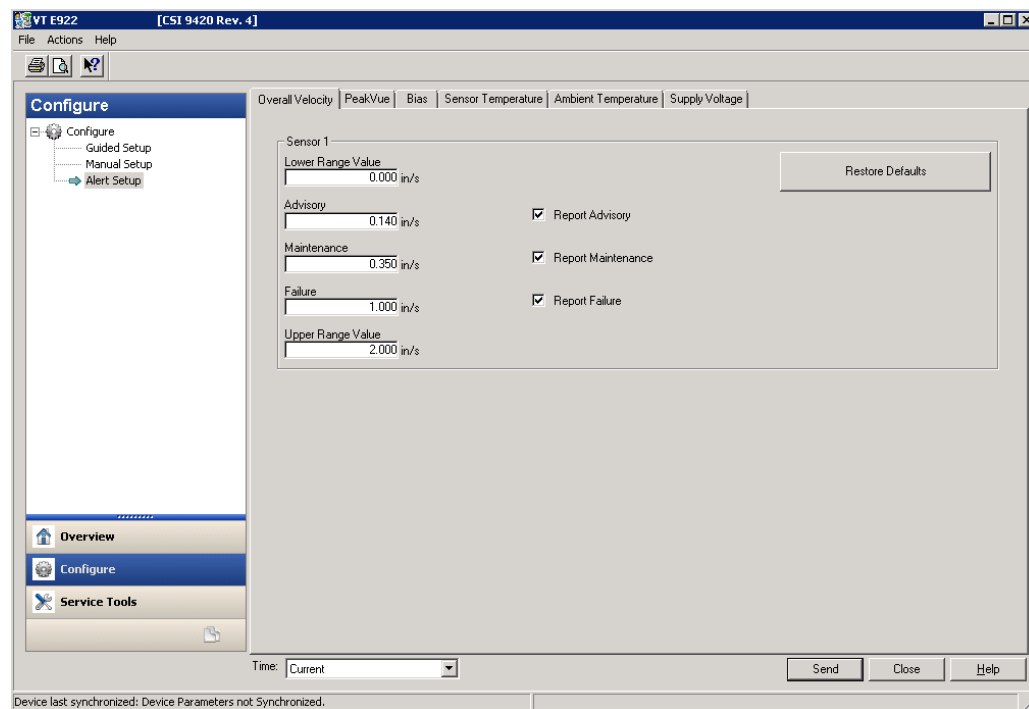

Click the corresponding sensor/device variable tab and select the **Report Advisory**, **Report Maintenance**, or **Report Failure** check boxes to generate alarms when actual measured values exceed the thresholds specified. When these check boxes are not selected, no alarm is reported.

Click **Restore Defaults** to restore default alarm thresholds for the selected variable.

Service Tools

Figure 3-30: Service Tools window

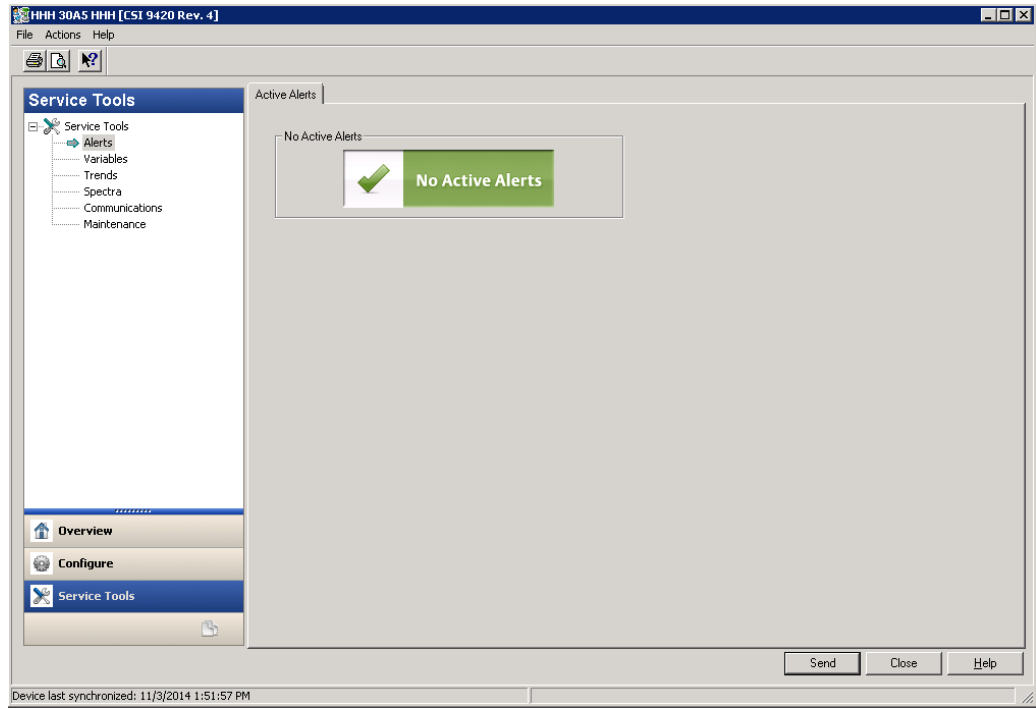

The Service Tools window displays alert conditions. These include hardware and software malfunctions or parameters with values beyond specifications.

Alerts

Click **Alerts** to display active alerts for the device.

Variables

Click **Variables** to display graphical gauges of sensor and device variables.

Figure 3-31: Variables

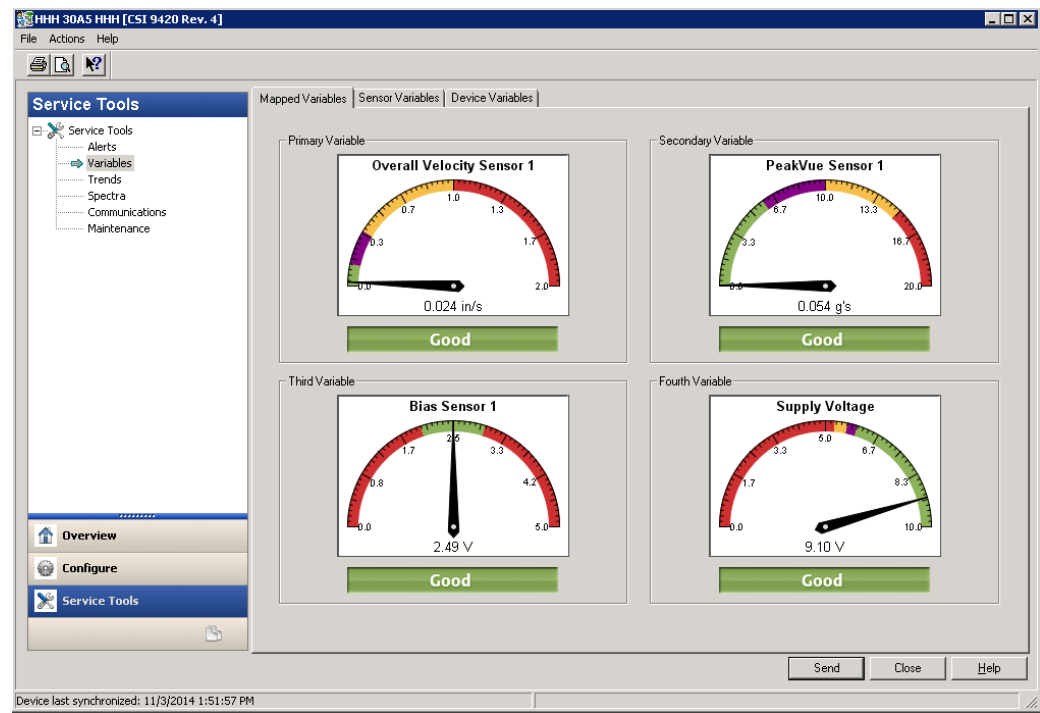

Click the **Mapped Variables** tab to display graphical gauges of variables and their mappings.

Click the **Sensor Variables** tab to display graphical gauges of the variables for each connected sensor.

Click the **Device Variables** tab to display graphical gauges of ambient temperature and supply voltage variables.

Trends

Click **Trends** to display hour-long trends for each of the four measurement variables (PV, SV, TV, and QV).

Figure 3-32: Trends

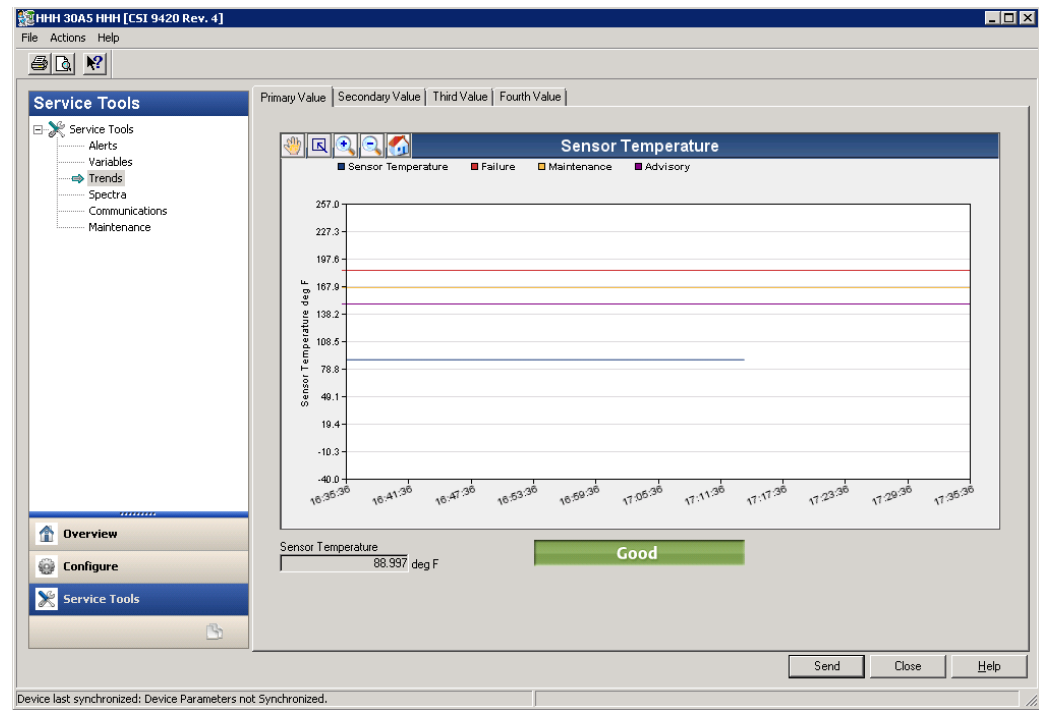

Note

The trend plots begin when **Trends** is selected, and continue to build as long as this remains selected.

Spectra

Click **Spectra** to display spectral and analysis parameter data and to configure spectral data acquisition settings. You can import spectral data to AMS Machinery Manager for further analysis.

Note

You must have the Advanced Diagnostics application license to view this feature. For more information on the Advanced Diagnostics application, see [Advanced Diagnostics application](#).

Figure 3-33: Spectra

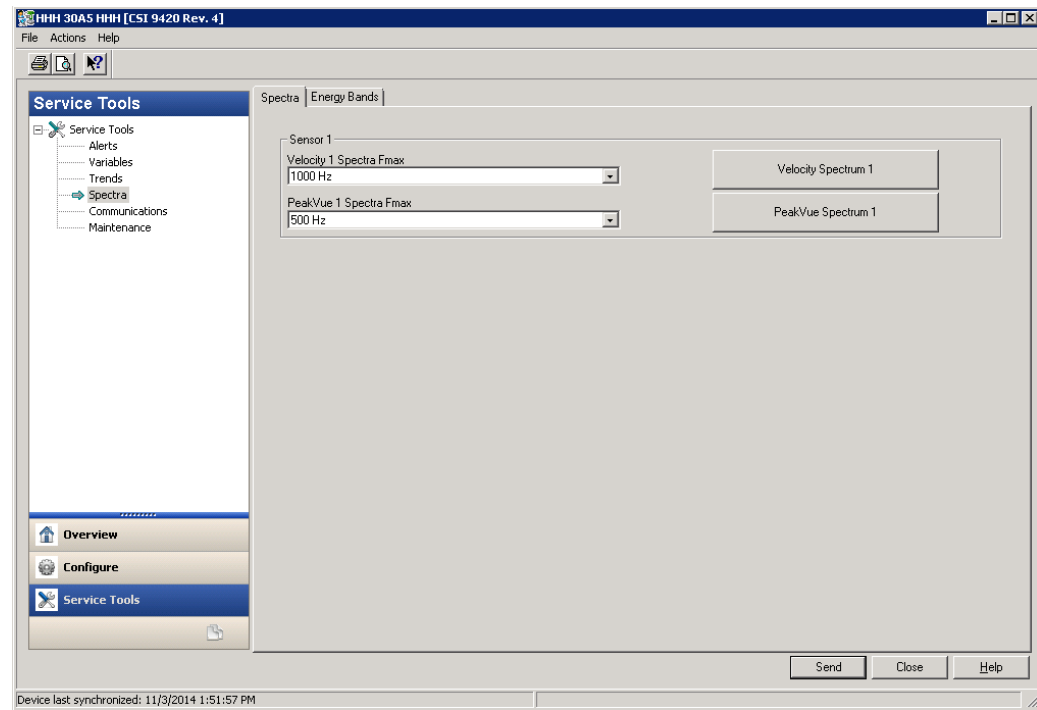

The Fmax settings define the default frequency range of the thumbnail spectra for Velocity and PeakVue. If you enable the Average Velocity option in AMS Machinery Manager, you can configure the high-resolution Velocity Analytical spectrum to return 400 or 800 lines of resolution, with averaging. If the Average Velocity option is not enabled in AMS Machinery Manager, the spectrum is calculated at 1600 lines of resolution, with no averaging.

When vibration data is acquired, a PeakVue waveform is sampled for 3.2 seconds. If you set the PeakVue True Fmax to 1000 Hz, the first 1.6 seconds of the PeakVue waveform is used for the analytical spectrum. If you set the Fmax to 500 Hz, the entire 3.2 second PeakVue waveform is used to calculate the analytical spectrum. Regardless of what you choose in Fmax, the overall PeakVue trend parameter is calculated over the entire 3.2 second waveform.

Click **Velocity Spectrum x** and **PeakVue Spectrum x** to display spectral plots of the latest acquired data for Velocity and PeakVue for connected sensors.

Figure 3-34: Velocity spectrum

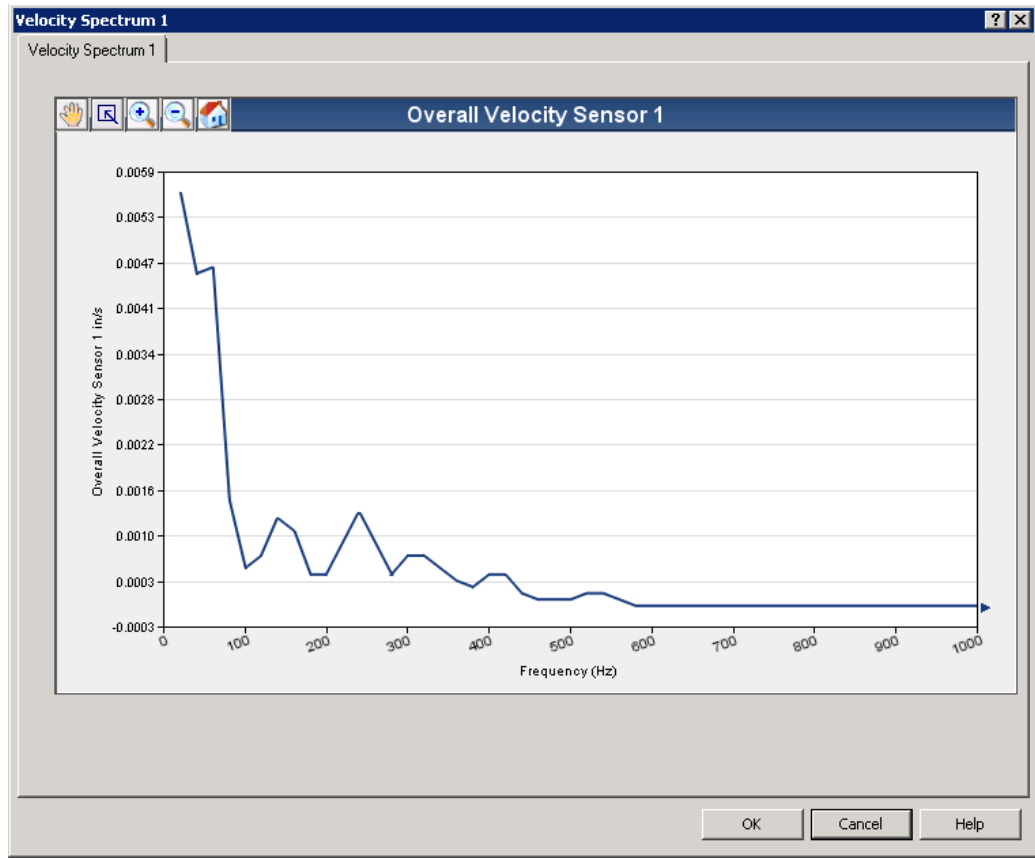
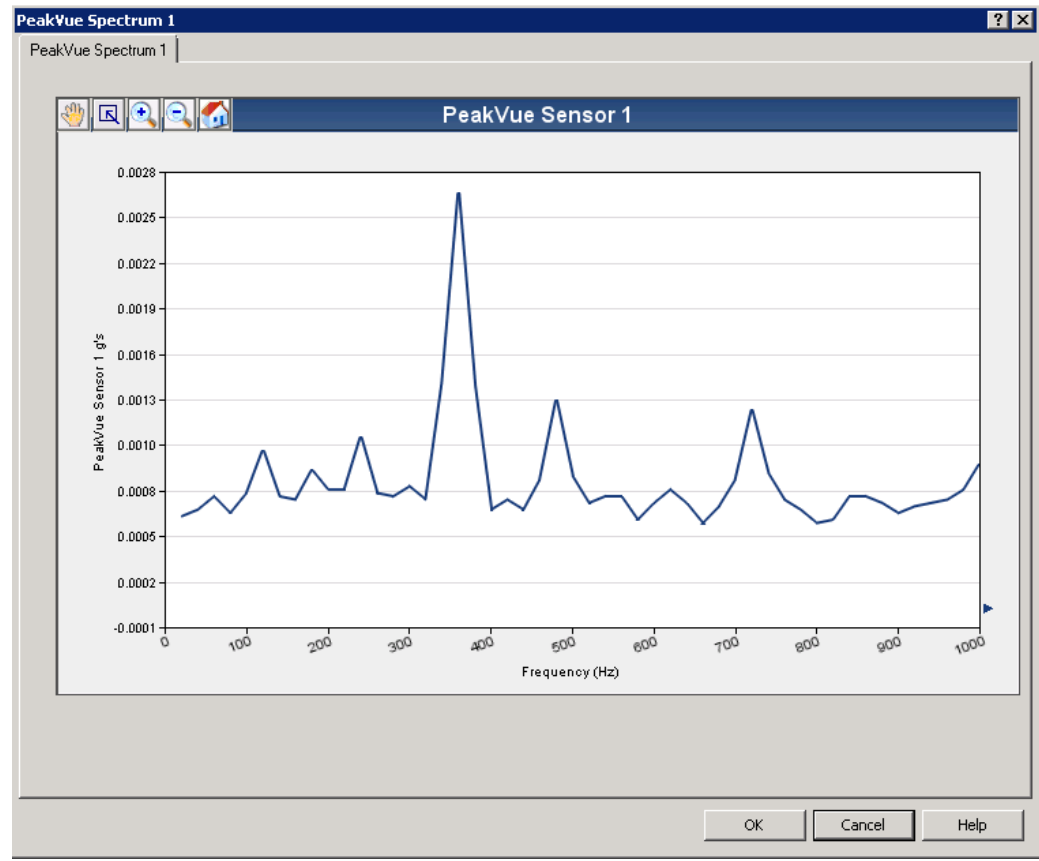
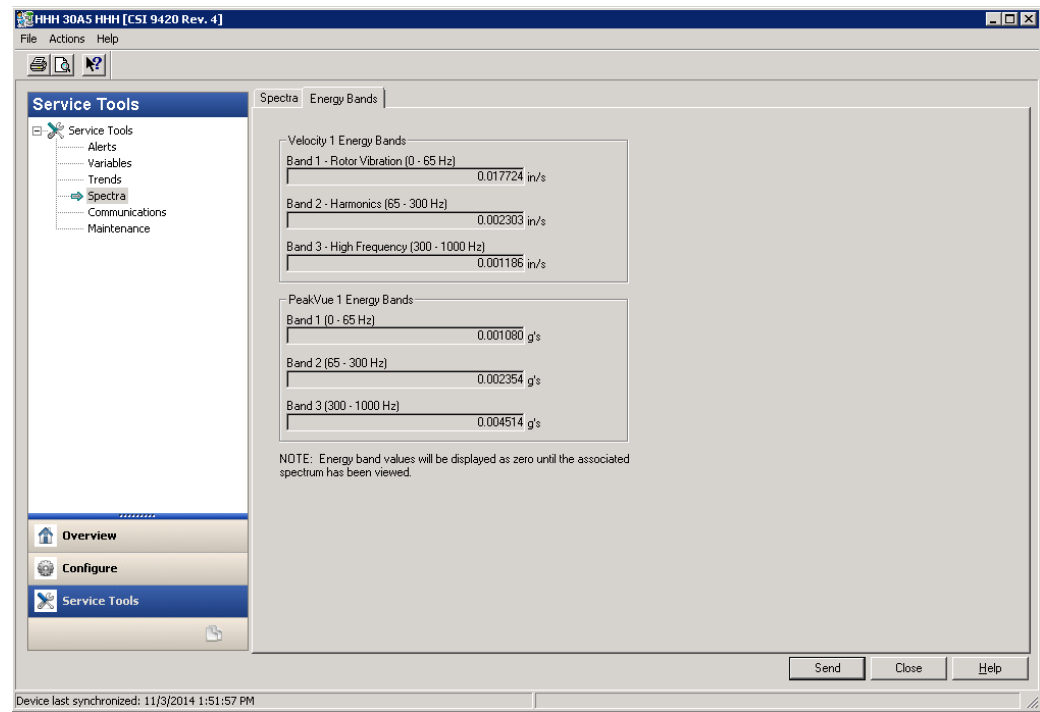

Figure 3-35: PeakVue spectrum



Click the **Energy Bands** tab to display calculated energy band values.

Figure 3-36: Energy Bands tab



Communications

Click **Communications** to display network join status information.

Figure 3-37: Communications

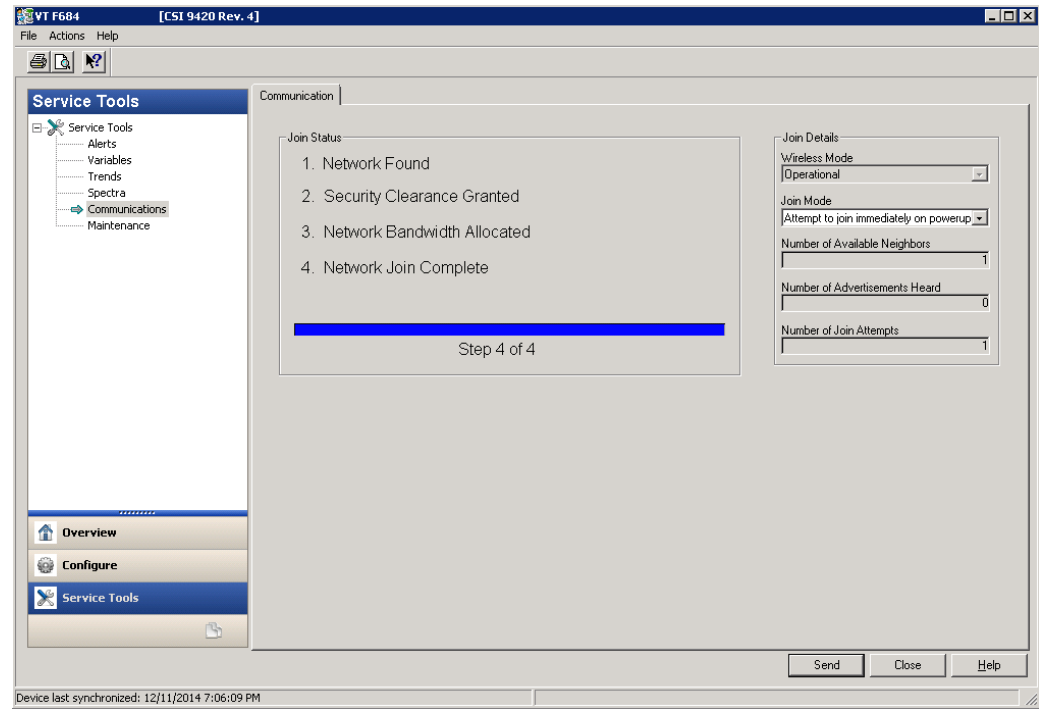

Click the **Join Mode** drop-down to select when the transmitter attempts to join a network.

Maintenance

Click **Maintenance** to manage the device maintenance and log settings.

Figure 3-38: Maintenance

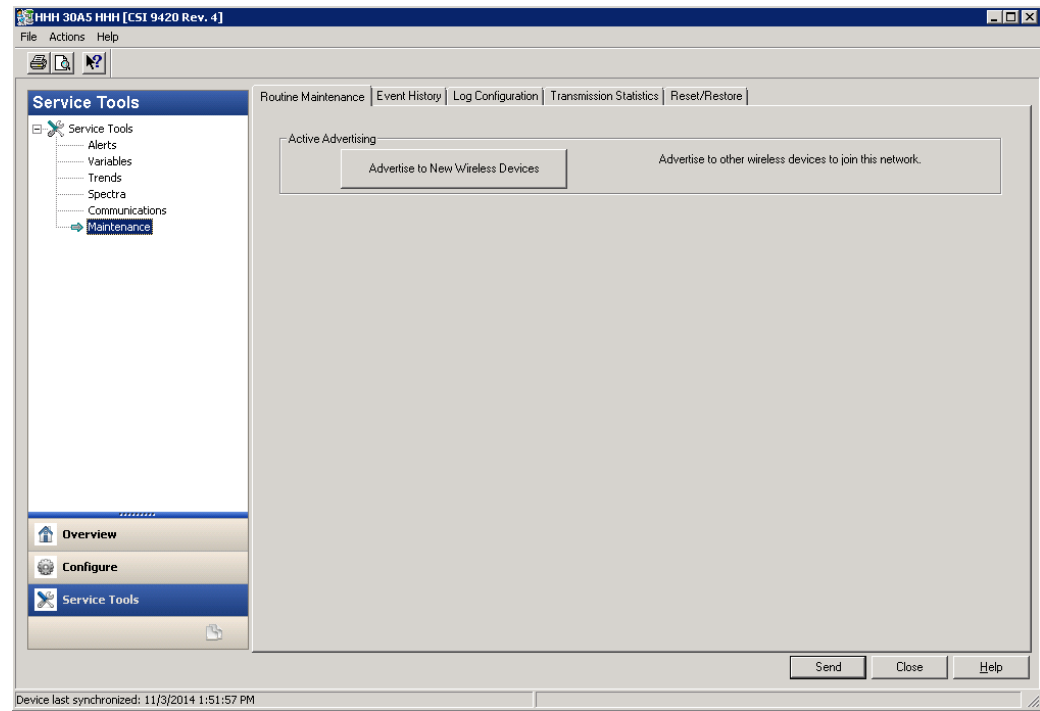

Click **Routine Maintenance tab** → **Advertise to New Wireless Devices** to enable the gateway to search for new wireless devices on the network. This helps new devices join the network faster.

Click the **Event History tab** to display transmitter events such as measurements, HART transmissions, and wake actions.

Click the **Log Configuration tab** to configure event logging options. Data from event logs are useful during a debug process.

Click the **Transmission Statistics tab** to display statistics related to radio transmission operation such as communication interval between data requests.

Click the **Reset/Restore tab** to reset the device or to restore factory default settings.

3.4 Configuration with AMS Machinery Manager

AMS Machinery Manager can change the data acquisition settings for AMS 9420 devices. If the device is not commissioned in a HART DCS host (DeltaV or Ovation), you can allow AMS Machinery Manager to configure settings to provide easier access. You need to configure MHM Access Control in AMS Device Manager or in a Field Communicator to allow AMS Machinery Manager to make configuration changes to the AMS 9420.

If the device is commissioned in a HART DCS host, manage the configuration completely within the DCS. The DCS will generate an alert if you change the configuration externally. For more details on how to change the configuration from AMS Machinery Manager, refer to the Data Import topics in AMS Machinery Manager Help.

For device configurations managed by the DCS, you can still set independent alerts in AMS Machinery Manager to allow you to get a notification without going to the DCS operator (for example, you can set an alert at a lower threshold within AMS Machinery Manager).

If the primary HART host is AMS Device Manager, you can manage all alert configurations and device update rates from AMS Machinery Manager. The independent alert levels are still possible (for example: a different alert level in AMS Machinery Manager than in AMS Device Manager). In this scenario, you have direct access to both settings. The HART alerts are stored in the device and appear in AMS Device Manager and Alert Monitor. AMS Machinery Manager alerts only appear when you are using the AMS Machinery Manager software. This type of configuration is also acceptable if the DCS or PCS host is using Modbus or OPC and not HART.

⚠ CAUTION

If the AMS 9420 devices are commissioned and installed on a HART DCS or PCS that is managing and archiving device configuration information, AMS Machinery Manager should NOT be used to change the configuration. This will cause an alert in the DCS due to the mismatch. The configuration may even be overwritten by the DCS, which can cause confusion.

3.4.1 Advanced Diagnostics application

The Advanced Diagnostics application is a licensed feature available in AMS 9420 devices. Contact your Emerson Sales Representative or Product Support for additional details.

When this feature is enabled, you can view a compressed thumbnail spectrum from a HART host, such as DeltaV or AMS Device Manager. The primary application however, is for integration with AMS Machinery Manager.

This feature allows you to retrieve compressed thumbnail spectra, high-resolution spectra, and analytical waveforms from the AMS 9420 and archive them in the AMS Machinery Manager database. Advanced Diagnostics provides additional insight, over and above the trended scalar values. This information provides a better indication of whether or not there is a real problem and, if so, how severe the problem is. By using Advanced Diagnostics, you can determine whether or not the vibration energy is periodic and at what frequency it is occurring.

Other configurable parameters for Advanced Diagnostics includes:

- **Effective Fmax for the thumbnail spectrum** — For the velocity thumbnail spectrum, AMS Machinery Manager uses 100% as the default Fmax.
- **PeakVue™ True Fmax** — This allows the monitoring of a slower machine with PeakVue. Choosing 1000 Hz Fmax uses about 1.6 seconds of data to produce a 1000 Hz analytical spectrum. Choosing 500 Hz Fmax uses about 3.2 seconds of data to produce a 500 Hz analytical spectrum. The 1000 Hz Fmax is better for 1800–3600 RPM machines. The 500 Hz Fmax is better for slower machines.

Note

True Fmax for PeakVue can only be configured in AMS Machinery Manager (MHM Access Control must first be enabled).

- **Averaging for the high-resolution velocity spectrum** — Averaging the velocity spectrum reduces the effect of anomalies that can occasionally appear in a vibration signal. Averaging also reduces the size of the data collected. If you use averaging, the frequency resolution of the high-resolution spectrum is 1.25 Hz/bin (800 lines) or 2.5 Hz/bin (400 lines). If you do not use averaging, the frequency resolution is 0.625 Hz/bin (1600 lines). The Fmax for all velocity spectra is 1000 Hz. Averaging is enabled by default. Device Revision 3 has the option of using 800 lines. Device Revision 4 can use either 800 or 400 lines (default).

Data acquisitions can be on-demand, alert-based, or time-based. You can configure data acquisition settings in the AMS Machinery Manager Data Import program.

An on-demand spectrum (usually a thumbnail) provides a quick look at the vibration energy in the frequency domain. If you need more frequency resolution, you can obtain a high-resolution spectrum or a waveform. You can store data in AMS Machinery Manager database if the point is mapped.

You can configure time-based data acquisitions once; it happens automatically thereafter. You can define the type of data to collect (compressed spectrum, high-resolution spectrum, or waveform) and how often to collect and store data in the AMS Machinery Manager database. AMS Machinery Manager automatically stores all time-based data retrieved for future viewing and analysis.

With Alert-based data acquisitions, overall vibration and PeakVue measurements are processed to determine the alert state of the equipment being monitored. Then you can select at what alert level to trigger retrieval of the spectrum or waveform associated with that sensor. Alert-based data acquisition typically results in a longer life for your Smart Power Module.

Notes

- It is not necessary to transmit both waveform and spectrum from the AMS 9420. The spectrum is about half as much data to transmit as a waveform. If you need the waveform, the spectrum does not have to be transmitted because the software calculates the spectrum from the stored waveform.
- When using a power module, use care when configuring time-based retrieval of energy band. Transmitting high-resolution spectrum or waveforms consumes more energy and reduces the life of the power module.

When using a power module, the maximum recommended time-based acquisition rates are:

- Thumbnail spectrum — Once per day
- High-resolution spectrum — Once every two weeks
- Waveform — Once per month

On-demand data collection is not expected to have a significant impact on power module life. If you are using a power module, keep in mind that even on-demand acquisitions can have an adverse effect on the power module life if you request data, especially high-resolution data, too frequently.

For more information on these data acquisitions, refer to the Data Import topics in AMS Machinery Manager Help.

Enable Advanced Diagnostics application (standard)

You can remotely upgrade an installed AMS 9420 that is already part of a wireless mesh network using either AMS Wireless Configurator or AMS Device Manager. There is no need to walk to the device or remove it from the field.

Note

If your AMS 9420 is not yet installed in the field, refer to [Advanced Diagnostic Option - optional installation](#) for instructions on how to perform the upgrade using a HART modem or a 375 or 475 Field Communicator.

1. In AMS Device Manager, select the AMS 9420 device that you want to configure.
2. Verify that the device is Rev 4.

Figure 3-39: Verify device revision

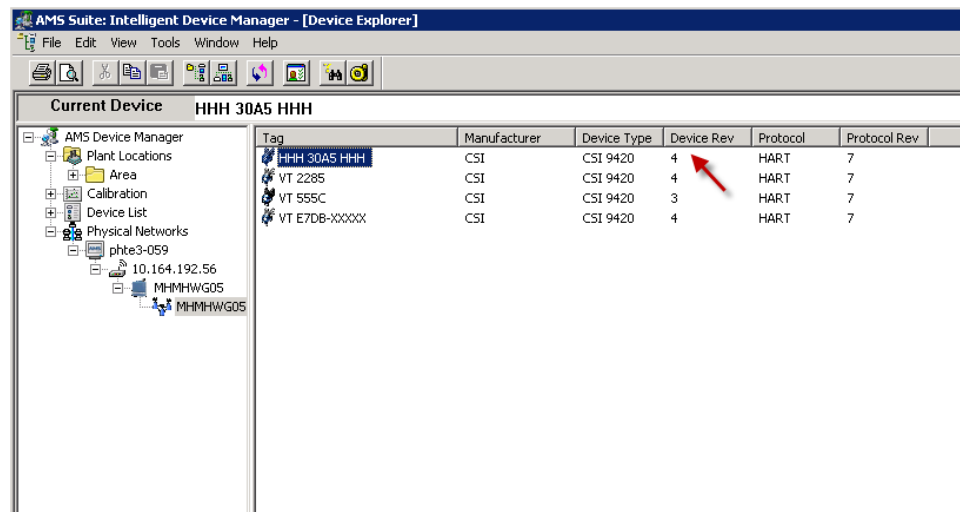

Note

If you have an older device revision, a factory upgrade may be possible in some cases. Contact Product Support for more information.

3. Right-click the AMS 9420 device and select **Configure**.
4. From the Configure window, select **Current** from the Time drop-down menu.

5. Click **Manual Setup** → **License tab** → **Configure License**.
6. Select **Yes** to enable the Advanced Diagnostics application.
This displays the serial number and request number. Call or email Product Support and provide this information. Product Support will issue a registration key.
7. Enter the registration key and click **Next**.
8. Click **Finish** when done.

Enable Advanced Diagnostics application (alternative)

If your AMS 9420 is not installed on a wireless network, you can perform the upgrade using either a HART modem or a 375 or 475 Field Communicator.

⚠ WARNING

The hazardous area rating available with the AMS 9420 does not permit either of the following operations to be performed in a hazardous area. Do NOT open the device and connect to the wired HART terminals in a hazardous area without taking the appropriate safety precautions required by local, national, or international regulations.

Note

Connecting directly to the wired HART terminals on the AMS 9420 temporarily takes the device off of the wireless network. If in range, it automatically rejoins the wireless network after the wired connection is removed.

Method 1 - Using a wired HART modem

1. Launch AMS Device Manager.
2. Connect the AMS 9420 to an AMS Device Manager PC directly using a HART modem.
3. Follow the steps in [Enable Advanced Diagnostics application \(standard\)](#).

Method 2 - Using a 375 or 475 Field Communicator

1. Use the lead set to connect the Field Communicator to the AMS 9420 terminal block.
2. Power on the Field Communicator, and select **HART Application** from the main menu.
Depending on the Device Descriptor (DD) file in your AMS 9420, you may get a warning message. Click **CONT** to proceed to the main menu.
3. Select **Configure** or press 2 on the keypad.
4. Select **Manual Setup** or press 2 on the keypad.
5. Select **License** or press 6 on the keypad.
6. Select **Configure License** or press 2 on the keypad.
7. Select **Yes** or press 1 on the keypad.
This displays the serial number and request number. Call or email Product Support and provide this information. Product Support will issue a registration key.
8. Enter the registration key in the space provided and press **ENTER**.

3.4.2 AMS 9420 Data Collection: Overview

Data collection on the AMS 9420 involves taking an acquisition and storing it in memory where it is available to be transmitted. AMS Machinery Manager obtains data from the AMS 9420 through the Data Import Server communication to the gateway device. You can

view or change data collection settings through AMS Machinery Manager, in the Data Import program. You can set up policies and fine-tune your data collection based on time or alerts.

To make changes to an AMS 9420, AMS Device Manager settings must allow AMS Machinery Manager to make changes.

Note

In some cases, if the gateway device is connected to a HART host such as DeltaV, any changes made using the AMS Machinery Manager software will be rejected. In such cases, contact your DeltaV administrator or an instrument technician who is authorized to make the required configuration changes.

Alert-based data collection (Enable Store on Alert)

When you chose an alert-based data collection, overall vibration and PeakVue measurements are processed to determine the alert state of the equipment being monitored. Then you can select at what alert level to trigger retrieval of the spectrum or waveform associated with that sensor. Alert-based data collection typically results in a longer life for your Smart Power Module.

Time-based data collection (Disable Store on Alert)

When you choose time-based data collection, you can store waveforms, high-resolution spectra, and thumbnail spectra are requested on a timer. The same information is collected periodically without regard to the device's alert status. Time-based data collection typically shortens the life of your Smart Power Module.

AMS 9420 Publishing Policy

The Data Import program provides an easy credit-based system to control how often data is collected and transmitted from each of your AMS 9420 transmitters. You can collect on-demand acquisitions without impacting the AMS 9420 Publishing Policy.

On-demand acquisitions

When you collect on-demand acquisitions you do not impact the AMS 9420 Publishing Policy. Time-based or Alert-based acquisition requests will continue according to the acquisition parameters for that device. All acquisitions, however, impact the life of your Smart Power Module.

3.4.3 AMS 9420 publishing policy

The AMS 9420 publishing policy is a credit-based system to control automated data requests and publishing rates. It helps you easily limit data traffic and data collection on your AMS 9420 transmitters. For AMS 9420 transmitters with a Smart Power Module, a publishing policy also helps extend the life of the power module by limiting the data collection and publishing. The publishing policy does not prevent on-demand readings. You can collect an on-demand reading from the AMS 9420 at any time.

The publishing policy may help if you have many transmitters and have some of the following concerns:

- You want to conserve the life of your Smart Power Module.
- You may have a control environment.

- You want to limit how often you request data.
- You want to limit how often you collect and store data.

Consider the following example in which an AMS 9420 is configured for a 60 minute update rate and to request the PeakVue spectrum whenever the PeakVue value exceeds 10 g's. If the measurement stays above 10 g's for an extended period of time, AMS Machinery Manager, without a publishing policy, would request a new spectrum with every measurement or once every hour. Each subsequent spectrum adds relatively little value in terms of diagnostic capability, but continues to consume power, which needlessly shortens the life of the power module. It also consumes unnecessary bandwidth, which might jeopardize the system's ability to retrieve pertinent diagnostic data from other devices. The default AMS 9420 publishing policy would restrict duplicate transmissions from this particular transmitter for two weeks. If the PeakVue level were still above 10 g at that time, then the publishing policy would permit the transmitter to send through an additional spectrum. This pattern would continue every 2 weeks until the issue is resolved.

How a publishing policy works

The publishing policy is based on gateway credits, device credits, and a polling interval. Credits are consumed by automated data collection based on the acquisition type. On-demand acquisitions do not consume credits. The credits are applied and used per polling interval. If the polling interval is too short, a device may send data too often, clog the network bandwidth, and run down the power module. Therefore, you should set the polling interval to the longest time period that is practical.

Table 3-10: Device credit consumption by acquisition type

Acquisition	Credit
Spectrum (time-based or alert-based)	1
Waveform (time-based or alert-based)	2
Spectrum or Waveform (on-demand)	0

You can determine if a device has consumed all of its credits by viewing the AMS 9420 device status. In Data Import, expand the Device Hierarchy to an AMS 9420, right-click the AMS 9420, and select **Get Status**. A status message at the bottom of the screen displays the date and time when the device will be eligible to collect data automatically.

Data storage and retrieval order with alert-based data collection

Combining a publishing policy with alert-based automated data collection provides more control over data collection, while ensuring you have the latest data when the conditions worsen. If more than one transmitter sends alerts at the same time, the requests are handled on a first come, first served basis. Newer transmitters (units with software rev 6.0 or higher) will retain the alert data in a protected memory buffer until it is retrieved by AMS Machinery Manager. For older transmitters (units with software below rev 6.0), AMS Machinery Manager will retrieve whatever data is contained in the transmitter's memory at the time the request is processed. Also, with a newer transmitter, if the condition gets worse while the data is waiting to be retrieved, the transmitter will update its stored data with the latest measurement due to the higher alert level.

How to apply a publishing policy

You can apply a publishing policy globally to a Data Import Server or individually to each gateway device.

- Apply a publishing policy to a Data Import Server to affect each gateway monitored by that server.
- Apply a publishing policy to one gateway device to affect only the AMS 9420 transmitters connected to that gateway device.

3.4.4 Maximum network size and publishing policy settings

The maximum network size for use with Emerson's Smart Wireless Gateway is defined in [Table 3-11](#).

Table 3-11: Maximum network size

Number of wireless devices	Update rate (in seconds)
12	1
25	2
50	4
100	8+

You can have up to 100 AMS 9420 devices on a single gateway, as the HART variables (i.e. scalar values) never have an update rate faster than 60 seconds. The update rate is typically once every 60 minutes.

The maximum network size decreases as you add different types of wireless devices to your network and when you collect high-resolution data. For example, if 5 temperature transmitters are broadcasting at a 1 second update rate, you will be able to add fewer AMS 9420 devices on this gateway than if the network contained only AMS 9420 devices. When you collect high-resolution data from a AMS 9420, such as vibration spectra and waveforms, the network can accommodate fewer wireless devices.

AMS Machinery Manager controls spectrum and waveform collection. The software features a publishing policy that limits the amount of data broadcast from a single device or over a single gateway. [Figure 3-40](#) shows the menu to configure the publishing policy in the (Modbus) Data Import program. [Table 3-12](#) shows the recommended (default) publishing policy settings. The default settings allow only 4 devices to send a full set of diagnostic data in a 24-hour period and no device will send data more often than every two weeks. This ensures that diagnostic data does not compete with process data, and that no single device dominates the available bandwidth.

Figure 3-40: AMS 9420 publishing policy menu

Table 3-12: Recommended (default) publishing policy settings

Network size	Interval (D:HH:MM)	Gateway credits	Device credits	Notes
N	N/4 days (but never less than 14.00:00)	N*8	8	High-resolution data limited only to 4 devices per day with most frequent collection interval of 2 weeks for 1-64 devices. After 64 devices, the collection interval increases to (N/4) days.

AMS Machinery Manager v5.61 features an auto-calculate button that populates the AMS 9420 Publishing Policy menu with default values shown in [Table 3-12](#).

If a gateway is dedicated to vibration monitoring and will not be routing any process data, then you can customize the publishing policy to allow more diagnostic data to be collected. Follow these steps:

1. Use the settings in [Table 3-13](#) and [Table 3-14](#) to achieve the maximum network size as indicated.

Table 3-13: Maximum network size when collecting velocity and PeakVue spectra only (no waveforms)*

Network size	Interval (D:HH:MM)	Gateway credits	Device credits
12	1.00:00	48	4
25	3.12:00	100	

Table 3-13: Maximum network size when collecting velocity and PeakVue spectra only (no waveforms) * (continued)

Network size	Interval (D.HH:MM)	Gateway credits	Device credits
50	7.00:00	200	
100	30.00:00	400	
*Set-up for average velocity spectrum and PeakVue spectrum.			

Table 3-14: Maximum network size when collecting velocity spectrum and PeakVue waveform*

Network size	Interval (D.HH:MM)	Gateway credits	Device credits
12	1.00:00	72	6
25	3.12:00	150	
50	7.00:00	300	
100	30.00:00	600	
*Set-up for average velocity spectrum and PeakVue waveform.			

2. Set up efficient data collection as follows:

- Use/create a well-formed network which conforms to best practices as described in the WirelessHART System Engineering Guide.
- Collect an averaged spectrum for overall vibration (recommended). Do not collect the waveform used to calculate the overall vibration value in the device itself. Starting in AMS Machinery Manager v5.61, the spectrum can be 400 lines instead of 800 lines, which further increases the availability of bandwidth. If you require the waveform from overall vibration, you can collect it on demand.
- For PeakVue, collect the waveform; the spectrum is always collected with the waveform. You need the waveform in order to use Auto-correlation to look for periodicity in the waveform. Auto-correlation helps you distinguish between impacting that is the result of under-lubrication or pump cavitation versus actual bearing damage.

3.4.5 Waveform or spectrum time

The amount of time required to get a waveform or spectrum varies significantly depending on the network size, network topology, and other installed applications competing for wireless bandwidth. Demand-based acquisitions use a special high-bandwidth mechanism that can transfer a 4096-point waveform in less than 5 minutes in optimum conditions, although it can take as much as 1 hour in fully loaded networks. Time-based acquisitions run at a lower bandwidth and typically take at least 30 minutes to acquire the same waveform.

Refer to the Data Import topics in AMS Machinery Manager Help for more details.

Energy Band trends

The transmitted thumbnail spectra, regardless of effective Fmax, also include Energy Band parameters which cover the entire frequency range. The Energy Bands for a 1000 Hz spectrum are:

- 0 Hz – 65 Hz
- 65 Hz – 300 Hz
- 300 Hz – 1000 Hz

The Energy Band parameters can only be trended in AMS Machinery Manager, and they are trended in the same way as the other scalar parameters. The device does not publish these values—requesting these wakes the device just like any other special data request.

Trend values are a good way to view on-demand data from your AMS 9420 powered by a Smart Power Module because these trend values come from the Smart Wireless Gateway's cache. Viewing on-demand trends does not cause the AMS 9420 to collect or transmit data as on-demand spectra and waveforms do.

The maximum (fastest) recommended storage rate for the Energy Band parameters is every 8 hours.

Refer to the Data Import topics in AMS Machinery Manager Help for more information.

4 Operation

Topics:

- [4.1 Verify the device is operational](#)
- [4.2 Verify operation with the integral LCD](#)
- [4.3 Verify operation with a 475 Field Communicator](#)
- [4.4 Verify operation with Emerson Wireless Gateway](#)

4.1 Verify the device is operational

You can verify the device operates properly using the following methods:





- Integral LCD (if installed)
- Field Communicator
- Emerson Wireless Gateway web interface

4.2 Verify operation with the integral LCD

If the LCD is installed and enabled, it displays a series of start-up screens as soon as you insert the power module.

[Table 1](#) shows the LCD screens when the AMS 9420 connects to a network.

Table 4-1: LCD network status screens

Searching for network	Joining the network	Connected to the network	Operational and ready to send data
			

For more information on LCD screen messages, refer to [LCD screen messages](#).

4.3 Verify operation with a 475 Field Communicator

You can verify the status of the AMS 9420 and configure it using a 475 Field Communicator. For instructions on using the AMS Trex unit, refer to the AMS Trex Device Communicator User Guide. For the 475, [Table 2](#) shows the fast key sequences you can use to configure and connect the AMS 9420 to a network. See [Configuration with a Field Communicator](#) for more information.

Note

HART Wireless transmitter communication requires a AMS 9420 Device Descriptor file (DD). Refer to the Field Communicator User's Manual for more details on DDs or go to <http://www.emerson.com/en-us/catalog/ams-475-field-communicator> for instructions on adding a DD for AMS 9420.

Table 4-2: Field Communicator fast key sequence—connect to a network

Key sequence	Menu item
2, 2, 1 (Manual setup)	Network ID Broadcast Info Join Device to Network Configure Publishing Configure Update Rate Transmit Power Level Default Burst Config
2, 1 (Guided setup)	Configure Sensors Configure Variable Mapping Configure Units Alert Limits Sensor Power Enable Join Device to Network Configure Publishing Configure Update Rate

Note

Disconnect the leads when you are finished configuring or troubleshooting. The AMS 9420 does not publish any new vibration data to the gateway while connected to an AMS Trex Device Communicator, 475 Field Communicator, or HART modem. It can take up to three minutes for the leads connection to time out; after which, the AMS 9420 resumes reporting new readings to the gateway.

4.4 Verify operation with Emerson Wireless Gateway

If the device is configured with the Network ID and Join Key, and sufficient time for network polling has passed, the transmitter will be connected to the network.

Note

The time to join a new device to the network is dependent upon the number of devices being joined and the number of devices in the current network. For one device joining an existing network with multiple devices, it may take up to five minutes. It may take up to 60 minutes for multiple new devices to join the existing network.

Procedure

1. From the Emerson Wireless Gateway Home page, navigate to the Devices page.

The Devices page shows if the device has joined the network and if it is communicating properly. It also displays the transmitter tag name, PV, SV, TV, QV, time of last update. A checkmark in a green box means that the device is working properly. A red indicator means there is a problem with either the device or its communication path.

Note

It is normal for the AMS 9420 to have a red “X”, on the screen until the sensor is installed and configured.

Figure 4-1: Emerson Wireless Gateway Devices page

Name	PV	SV	TV	QV	Last Update
+ <input checked="" type="checkbox"/> ProdSup1420-1	<input checked="" type="checkbox"/> 2	<input checked="" type="checkbox"/> 0	<input checked="" type="checkbox"/> 31.5 DegC	<input checked="" type="checkbox"/> 32.5 DegC	01/24/18 15:48:56
+ <input checked="" type="checkbox"/> VT 3BFD	<input checked="" type="checkbox"/> 0.011 in/s	<input checked="" type="checkbox"/> 0.021 std gravity	<input checked="" type="checkbox"/> 69.441 DegF	<input checked="" type="checkbox"/> 6.87 V	01/24/18 15:07:05
+ <input checked="" type="checkbox"/> VT 55E6	<input checked="" type="checkbox"/> 0.009 in/s	<input checked="" type="checkbox"/> 0.018 std gravity	<input checked="" type="checkbox"/> 0.019 in/s	<input checked="" type="checkbox"/> 0.034 std gravity	01/24/18 15:47:12

2. On the Devices page, click + beside a tag name to display more information about the device.
3. Verify the Network ID and Join Key in the device match those found on the Emerson Wireless Gateway:
 - a. From the Emerson Wireless Gateway, click **System Settings** → **Network** → **Network Settings**.
 - b. Verify **Show join key** has a check mark.

Note

The most common cause of incorrect operation is that the Network ID or Join Key are not set correctly in the device.

5 Overall Velocity, PeakVue, and temperature

Topics:

- [5.1 Overall Velocity](#)
- [5.2 PeakVue](#)
- [5.3 Temperature](#)

5.1 Overall Velocity

The Overall Velocity measurement provides a summation of the low-frequency vibration energy, which indicates fault conditions such as imbalance, misalignment, looseness, and late-stage bearing problems.

The AMS 9420 uses (lower-frequency) Overall Velocity in conjunction with (higher-frequency) PeakVue to provide a holistic solution across all frequencies while optimizing the usage of the limited power and bandwidth available in a wireless device. The majority of developing fault conditions manifest in one or both of these key parameters.

The difference between the standard vibration waveform and the associated PeakVue waveform is shown in [Figure 5-1](#) and [Figure 5-2](#). Overall Vibration indicates energy from shaft rotation, expressed in units of RMS velocity per the ISO 10816 standard. PeakVue, on the other hand, filters out the rotational energy to focus on impacting. Impacting is expressed in units of Peak acceleration. This indicates key mechanical problems such as rolling element bearing faults, gear defects, and under-lubrication.

Figure 5-1: Velocity waveform

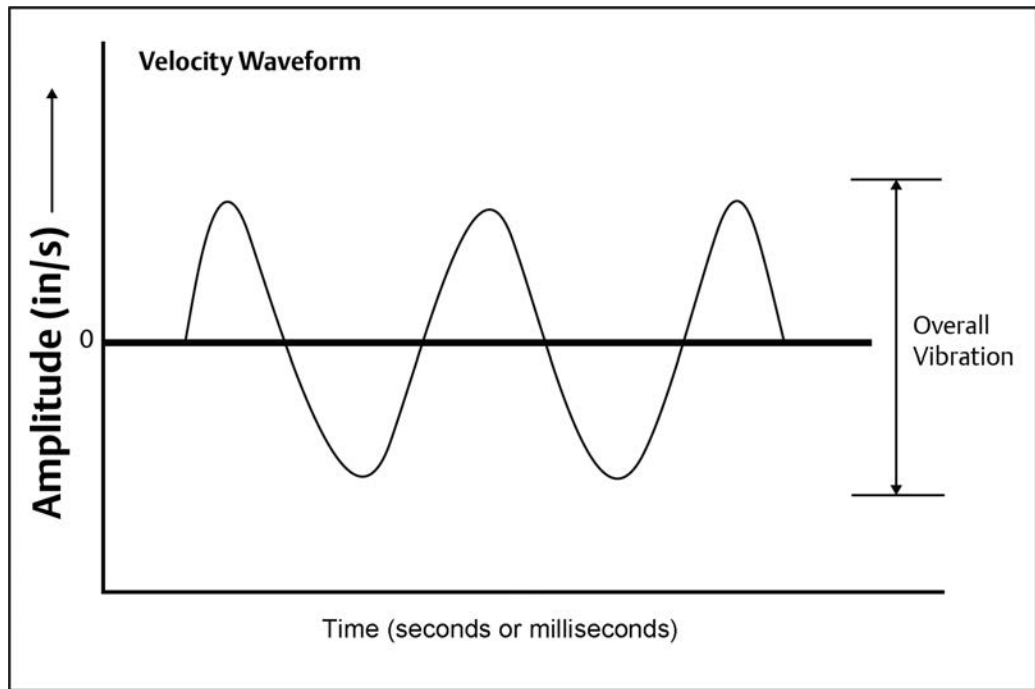
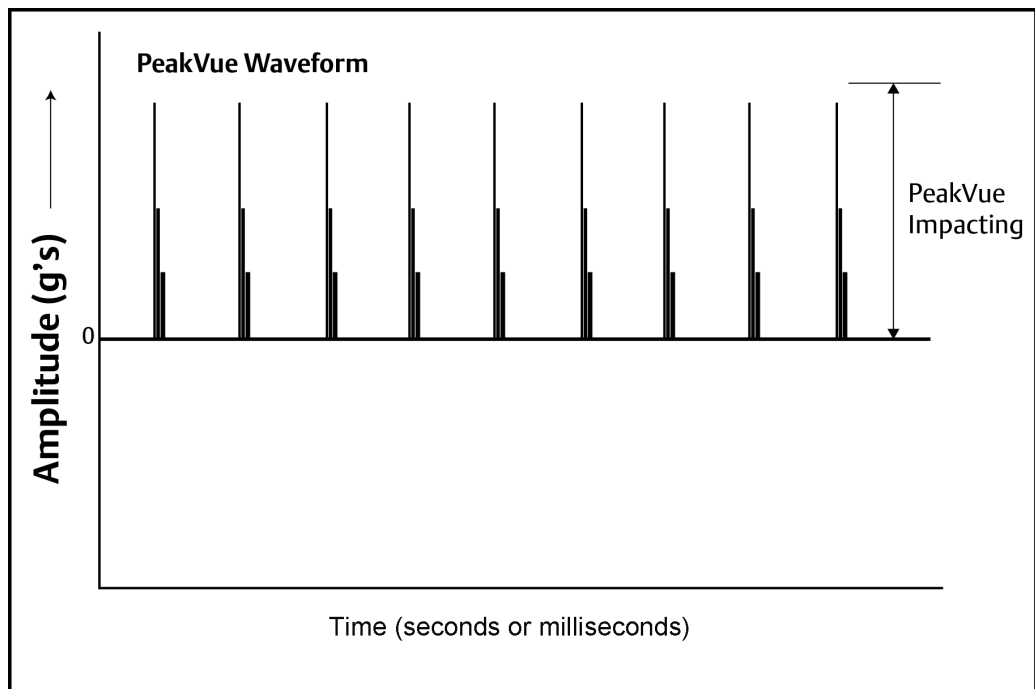

Figure 5-2: PeakVue waveform



While PeakVue is very useful for providing an early indication of impact-related faults in rolling-element bearings, there are many general applications where a lower-frequency

measurement is more appropriate. Also, virtually all vibration analysts are very familiar with the Overall Velocity measurement and use it as part of their existing vibration programs. While it may not be possible to obtain a measurement result comparable to the PeakVue value reported by the AMS 9420 with a non-Emerson unit, the Overall Velocity measurement is common throughout the industry and should be easy to correlate with results from handheld instruments.

There are, however, a number of different methods for measuring and reporting Overall Velocity, so ensure that the measurement conditions are similar when trying to duplicate the value reported by the AMS 9420 with a handheld. The AMS 9420 uses ISO 10816, which defines a measurement bandwidth of 2 Hz to 1 kHz. The ISO 10816 general fault levels at various turning speeds are shown in [Figure 5-3](#).

Figure 5-3: General fault levels

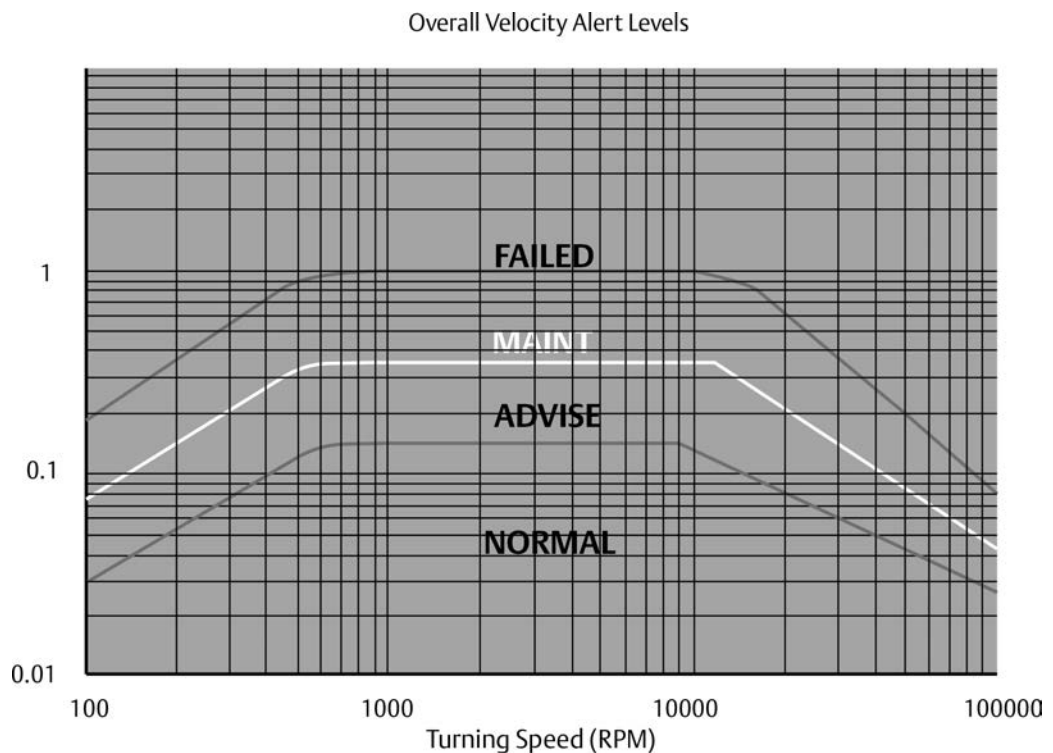

Depending on the type of machine being monitored, the values shown in this graph should be multiplied by the service factors given in [Table 5-1](#).

Table 5-1: Service factor multiplier

Machinery type	Service factor
Single-stage Centrifugal Pump, Electric Motors, Fans	1.0
Non-critical Chemical Processing Equipment	1.0
Turbine, Turbine Generator, Centrifugal Compressor	1.6
Miscellaneous Equipment	2.0

Figure 5-3 shows the Overall Velocity thresholds for root-mean-square (RMS) velocity in units of inches per second. Particularly, in digital acquisition systems, it is customary to measure and calculate with RMS quantities. While it is accepted practice in the industry to convert between RMS and peak values using the 1.4142 conversion factor, it is not technically correct to do so except for a pure sinusoidal waveform. For this reason, the AMS 9420 measures, calculates, and reports Overall Velocity in RMS, and it is necessary to multiply by 1.4142 to get the corresponding peak levels if this is the preferred format.

Table 5-2: Default velocity levels in AMS 9420

Alert level	Velocity (in RMS)
Advise	0.14 in/s
Maintenance	0.35 in/s
Failed	1.0 in/s

5.2 PeakVue

PeakVue™ is a patented Emerson technology that is very useful for isolating high-frequency phenomena associated with developing faults, especially in rolling-element bearings.

The premise for PeakVue is that the high-frequency components are not readily detected with more conventional measurements such as Overall Velocity, low-frequency energy (LFE), or digital overall. This is because the low-frequency measurements either average the energy or provide an energy summation over a relatively large frequency band, and the relative amount of energy that is typically contributed by the high-frequency components is quite small. As a result, even large "spikes" are difficult to detect with classic techniques.

The difference in the vibration waveform and the associated measurement for overall vibration versus PeakVue is shown in Figure 5-5 and Figure 5-6. The overall vibration is well below the established advisory and maintenance alert levels indicating that the machine is running well. In contrast, the PeakVue graph shows that the values have increased from zero, and that they are already crossing the advisory alert level and approaching the maintenance alert level. This early warning about impending defects is key to maintaining good machine health.

The PeakVue algorithm isolates the peak energy of interest to provide early indications of developing bearing faults such as inner and outer race defects, ball defects, and lubrication problems. Any type of "impacting" fault, where metal is contacting metal, is readily visible with PeakVue long before there is any significant increase in Overall Vibration. PeakVue is especially useful for monitoring rolling-element bearings.

Figure 5-4 shows an example of a typical formula for calculating the advisory alert level for PeakVue.

Figure 5-4: PeakVue advisory levels

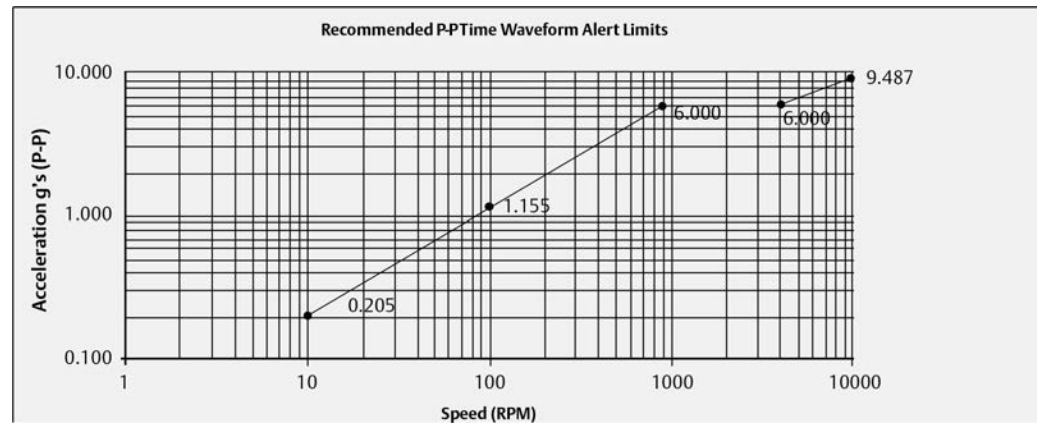

These are the equations that govern this curve:

$$g's = \left(\frac{RPM}{900}\right)^{0.75} \times 6 \text{ for } RPM < 900$$

$$g's = 6, \quad \text{for } 900 < RPM \leq 4000,$$

$$g's = \left(\frac{RPM}{4000}\right)^{0.5} \times 6 \text{ for } 4000 < RPM \leq 10000,$$

$$g's = 10, \quad \text{for } RPM > 10000,$$

These, however, are generic limits. They are provided as a starting point and these values (for a 3600 RPM machine) are used as the default alert thresholds by the vibration transmitter.

These levels were devised for periodic data collection with a portable vibration analyzer and are set relatively low. For frequent automated monitoring, such as that offered by the AMS 9420, the levels can be increased for most balance of plant equipment running between 900 and 4000 RPM. You can use the "rule of tens" as a simple but effective approach to monitoring PeakVue on most rolling element bearing machines. Using this guideline, we can assume the following:

Level	Interpretation
0	Machine is in good condition
10	Some problem is developing on the machine
20	The problem has become serious
40	Problem is critical

Note

The appropriate alerts for a given machine will be a function of its design, service, and turning speed.

Utilizing the embedded PeakVue technology, the AMS 9420 identified developing problems at a couple of test sites during early field trials. In both cases, the problem was not visible with conventional low-frequency analysis. The following examples provide sample data from one of the sites. Notice in the example that the velocity measurement is

indicating less than 0.1 in/s. The PeakVue trend, however, indicates high-frequency vibration that is regularly in excess of 6 g's.

Figure 5-5: Example 1: 4600 HP fan motor - OH (Overall)

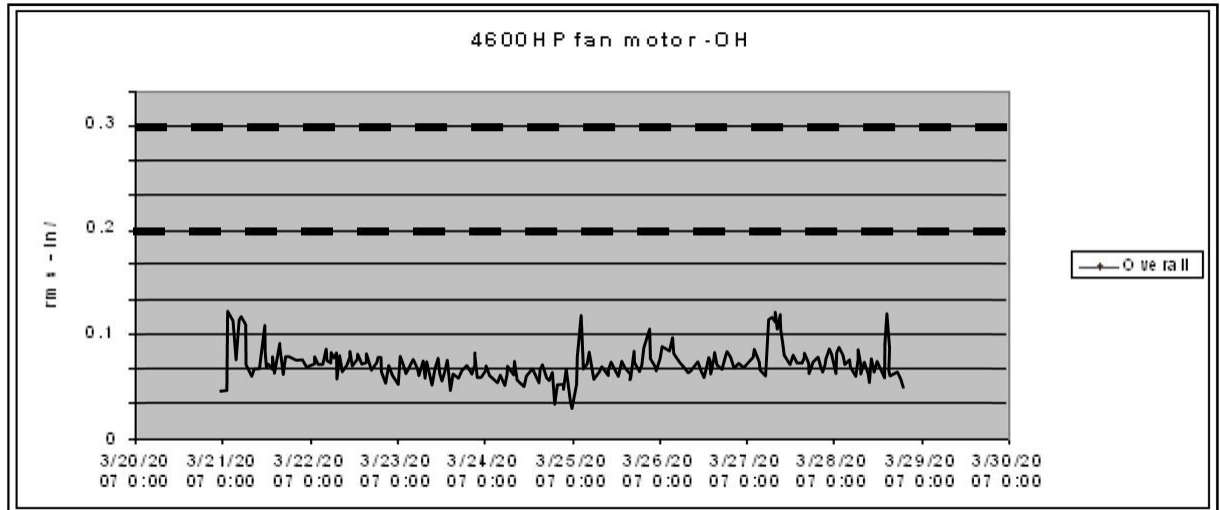
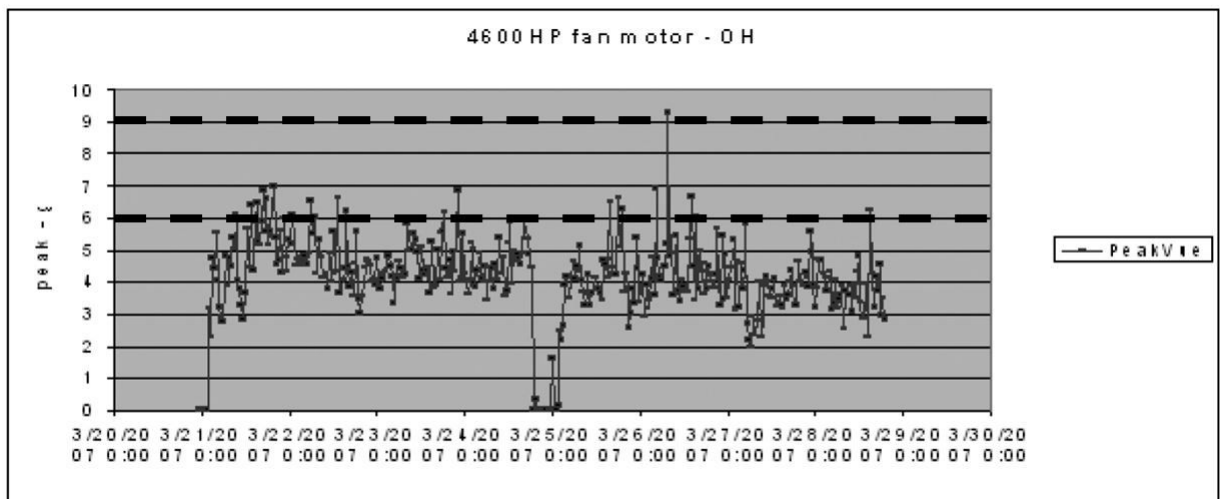

Figure 5-6: Example 2: 4600 fan motor - OH (PeakVue)



The defective bearing was removed and [Figure 5-7](#) shows the developing problem that was the source of the impacting. After replacing the bearing, the PeakVue vibration is significantly reduced, as shown in [Figure 5-8](#), indicating that the problem has been resolved.

Figure 5-7: Defective bearing

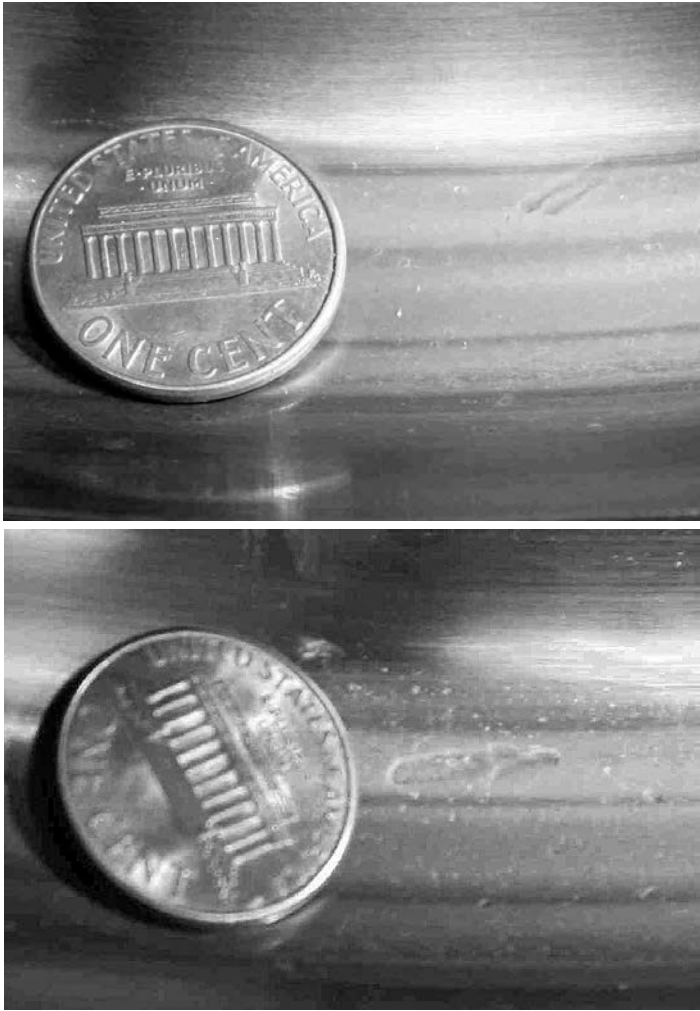
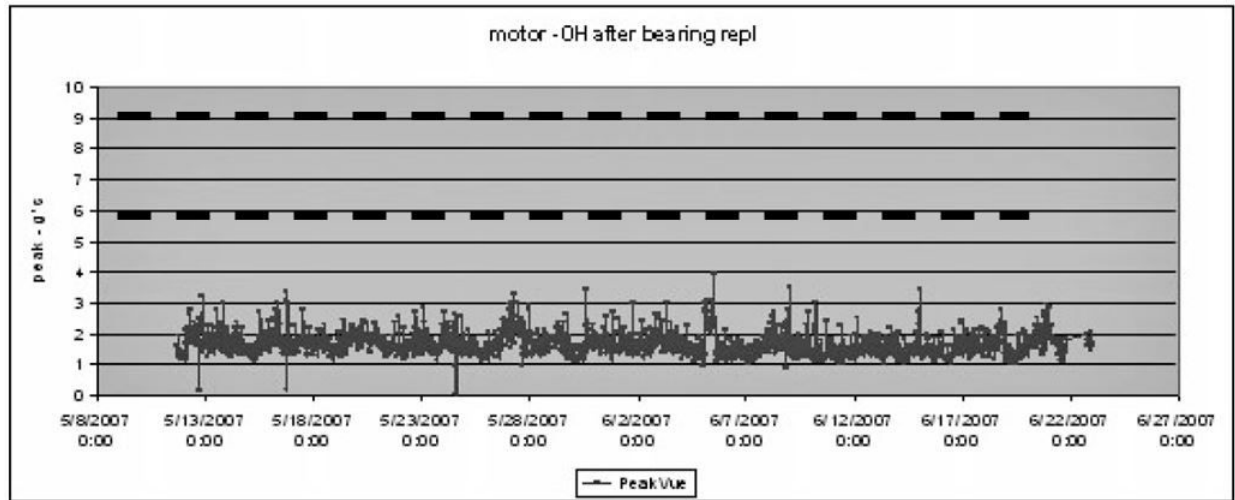

Figure 5-8: Motor - OH after the bearing is replaced (PeakVue)



5.3 Temperature

The levels at which to set temperature alerts depend on a number of factors including the specific process, the operating environment, and the characteristics of the equipment being monitored. This section provides some generic guidelines, given some knowledge of the variables involved, for setting the thresholds for your specific AMS 9420 installation. However, the generic methodologies described here are no substitute for first-hand knowledge of your plant. If, for example, you know that you have problems when a temperature exceeds a particular value, then set your thresholds accordingly rather than following these generic guidelines.

In general, the best way to detect a developing fault related to temperature is to look for an increase in temperature, relative to ambient, over time. This implies that, for reliable alerting, the thresholds should change as ambient temperature changes. In practice, this can be difficult to do because it requires the operator to constantly monitor the ambient temperature and adjust the alert levels accordingly. It is customary, therefore, to pick an "average" ambient temperature (that is generally seasonal for outdoor installations) and choose fixed thresholds based on this average. Also, there are issues with this methodology (such that it does not work well) in areas with large variations in ambient temperature.

You can select thresholds based on some absolute temperature limit. In practice, this is much easier to maintain but is not as effective at detecting early failures as relative monitoring.

5.3.1 Relative temperature monitoring

The recommended generic guidelines for setting the thresholds based on the relative change are:

$T_{\text{Advise}} = 10^{\circ}\text{C}$ increase

$T_{\text{Maintenance}} = 15^{\circ}\text{C}$ increase

$T_{\text{Failed}} = 20^{\circ}\text{C}$ increase

Assuming that the ambient temperature is 25°C , when operating at steady-state, you have determined that the normal temperature at this point on your equipment is 55°C . Your "baseline" relative difference is 30°C . Using these guidelines, you should choose the Advise, Maintenance, and Failed levels for a difference of 40°C , 45°C , and 50°C , respectively. Assuming the ambient temperature is constant at 25°C , this means the thresholds become 65°C , 70°C , and 75°C for Advise, Maintenance, and Failed, respectively. Then, as the ambient temperature changes, the thresholds should be changed accordingly (e.g., a 5°C increase in ambient temperature raises the alert thresholds by 5°C).

5.3.2 Absolute temperature monitoring

For monitoring a driven component (such as a pump or fan), there are no generic rules to determine the default levels without some prior knowledge of the steady-state baseline (good) value. In general, the Advise level should be set about 10°C to 20°C above this baseline, with the Maintenance level about 10°C above Advise and the Failed level about 10°C above Maintenance.

There are equations that define the suggested generic thresholds for monitoring motor (driver) temperature. These are based on characteristics of the motor as well as knowledge of the ambient temperature.

The first step is to determine the estimated winding temperature, which is dependent on the following variables:

- Insulation type
- Motor type
- Ambient temperature
- Altitude

The estimated winding temperature, T_W , is the rise in temperature, T_{rise} , for the appropriate type of motor adjusted for high ambient temperature (T_a) effects.

$T_{\text{rise}} =$

- $65^{\circ}\text{C} + \text{serv_fact_temp}$; for class A insulation
- $85^{\circ}\text{C} + \text{serv_fact_temp}$; for class B insulation
- $110^{\circ}\text{C} + \text{serv_fact_temp}$; for class F insulation
- $130^{\circ}\text{C} + \text{serv_fact_temp}$; for class H insulation
- $150^{\circ}\text{C} + \text{serv_fact_temp}$; for class N insulation

where $\text{serv_fact_temp} =$

- 5 for service factor of 1.15 or greater
- -5 for either open or totally enclosed fan cooled (TEFC) motors, and service factor of 1.0
- 0 for either totally enclosed non-ventilated (TENV) motors or motors with encapsulated windings, and service factor of 1.0

If elevation > 3300 ft (1000m), then:

$$T_{rise} = T_{rise} \{1 - [(altitude \text{ (units of ft)} - 3300) / 33,000]\}$$

If T_a is less than or equal to 40°C (or unknown), then:

$$T_w = T_{rise} + 40^\circ\text{C}$$

If $T_a > 40^\circ\text{C}$, then:

$$T_w = T_{rise} + 40^\circ\text{C} - (T_a - 40^\circ\text{C})$$

If T_a is unavailable, assume that T_a is less than 40°C.

Next, calculate the generic alert thresholds based on the estimated winding temperature, T_w .

T_{f_fault} = Fault level alarm temperature (°C) of the motor skin (frame)

$T_{f_maintenance}$ = Maintenance level alarm temperature (°C) of the motor skin

$T_{f_advisory}$ = Advisory level alarm temperature (°C) of the motor skin

Alarm levels

For open drip proof (ODP) motors:

$$T_{f_fault} = 35.5366 * \ln(T_w) - 91.1571$$

For totally enclosed motors:

$$T_{f_fault} = 37.2028 * \ln(T_w) - 102.8868$$

For all motors:

$$T_{f_maintenance} = T_{f_fault} - 10^\circ\text{C}$$

$$T_{f_advisory} = T_{f_fault} - 20^\circ\text{C}$$

Error indication and steady-state determination

- Do not use any data readings collected within 30 seconds of motor start up.
- Check for error indications:
 - If $T_f > 150^\circ\text{C}$, the sensor is shorted.
 - If $T_f < -40^\circ\text{C}$, the sensor is open or the wire is broken.
- Steady-state is said to have been reached when, over any 5-minute time interval, the maximum variation in temperature is less than 2°F.

6 Mitigating EMI and RFI

Topics:

- [6.1 Accelerometer EMI and RFI considerations](#)
- [6.2 Mitigate interference](#)

To maximize immunity to EMI/RFI, consider the following when planning the installation of the AMS 9420 and its accelerometers:

Required

- Use ferrites to attenuate interference that couples into the accelerometer cable.
- Ensure the installation conforms with all local codes and regulations.

Best practice

- Use a shorter cable, if possible.
- Consider running accelerometer cables in conductive conduit, grounded on both ends.
- Avoid vertical cable runs because this geometry increases susceptibility to vertically polarized causes of interference.

6.1 Accelerometer EMI and RFI considerations

The AMS 9420 uses an accelerometer to measure vibration. The process involves a piezoelectric element, which produces a time-waveform with voltage amplitude proportional to acceleration. The input bandwidth of the measurement is approximately 20 kHz. This waveform is then digitized and analyzed within the AMS 9420 to produce the desired vibration parameters.

Due to the high-frequency nature of the measurement, it is inherently susceptible to electromagnetic interference (EMI) and radio frequency interference (RFI), which can cause distortions in the measurement. This section discusses ways to mitigate, eliminate, or at least significantly reduce these effects.

Note

The mitigating strategies discussed here only apply to the measurement of vibration, as an accelerometer only measures vibration. If you use a sensor that has both vibration and embedded temperature capabilities, these strategies will only work for the vibration measurement part of the sensor.

The primary source of the susceptibility is the cable between the accelerometer and the transmitter housing. Longer cable lengths act like antennas at high frequencies, and as such, receive radio frequency (RF) energy and transfer it to the measurement electronics, which is indistinguishable from the signals it is specifically designed to detect.

[Figure 6-1](#) shows two lab instruments displaying accelerometer signals with and without interference. The one on top is an oscilloscope, which displays signals (in volts) in the time domain (signal amplitude as a function of time). The one at the bottom is a spectrum analyzer, which displays signals (in volts) in the frequency domain (signal amplitude as a function of frequency).

Figure 6-1: Accelerometer signal with and without interference

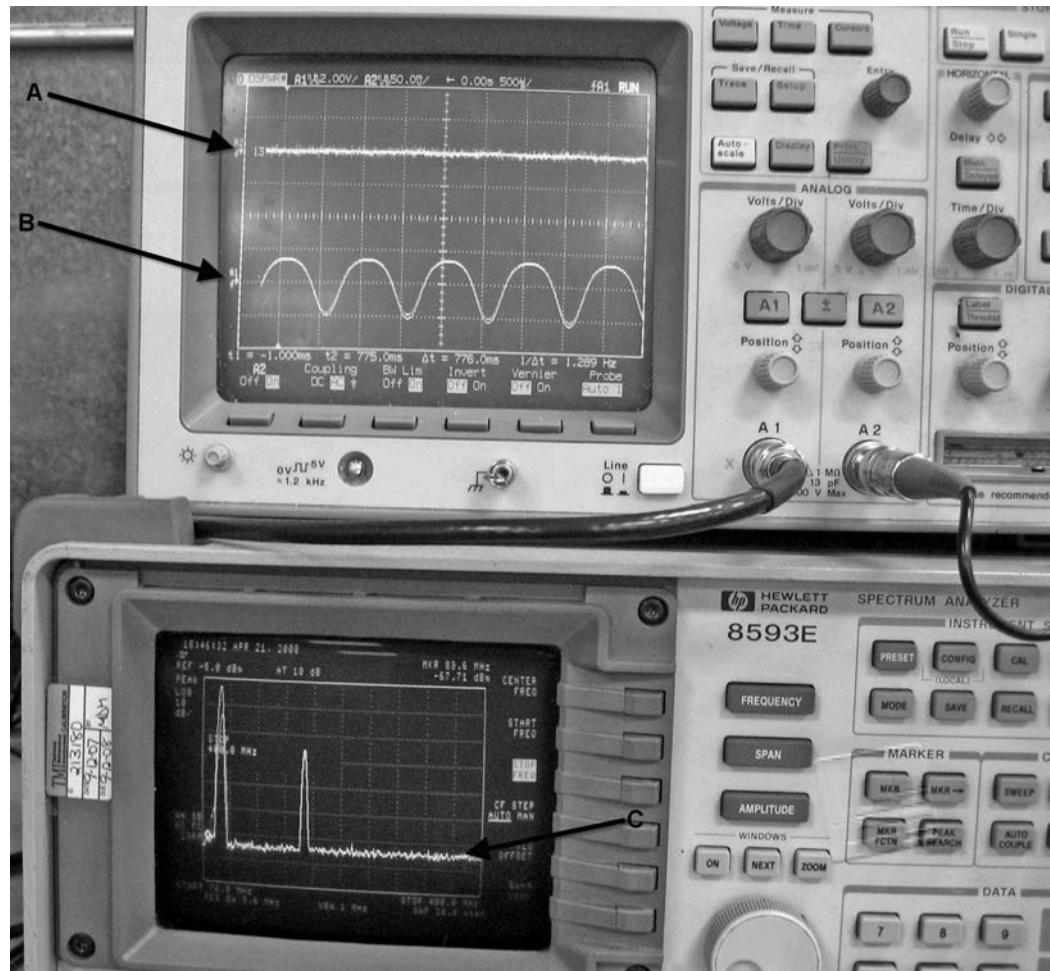

- A. Signal measured with no RFI effect.
- B. Signal in the presence of interference on a completely unmitigated accelerometer.
- C. Frequency spectrum representation of the signal with interference.

6.2 Mitigate interference

The following are four basic things you can do to reduce EMI and RFI on measurements:

- Use a shorter cable, if possible. For more details, see [Use shorter cable lengths](#).

Note

The leads on the sensor cables, as delivered, are specially prepared for ease of installation. Before attempting to cut the cables, be aware that cutting cables is associated with significant additional rework to correctly prepare the sensor for installation.

- Run the cable through a conductive conduit, grounded at both ends. For more details, see [Use a conductive conduit](#).
 - Install ferrites on the cable. For more details, see [Install ferrites](#).
 - Avoid running the cable such that it matches the polarization of expected interference sources. For more details, see [Reduce polarized interference](#).
-

Note

The best approach in mitigating interference also depends on the application and on local installation codes.

6.2.1 Use shorter cable lengths

Accelerometers are available with standard cable lengths of 10 meters (30 ft) and 29 meters (95 ft). Because the cable is the most susceptible component of the measurement system, the best way to avoid the problem of EMI/RFI is to use shorter cable lengths.

When planning the installation, keep in mind that shorter cable lengths significantly improve immunity to EMI/RFI. Try to keep cable runs as short as reasonably possible. Even 3-meter cables have some susceptibility in the presence of high-intensity RF fields; it is strongly recommended that you consider other mitigating strategies discussed in this section even if you are using shorter cables.

Note

The leads on the sensor cables, as delivered, are specially prepared for ease of installation. Before attempting to cut the cables, be aware that cutting cables is associated with significant additional rework to correctly prepare the sensor for installation.

6.2.2 Use a conductive conduit

Running the cable through a conductive conduit provides additional shielding and increases immunity to EMI/RFI. For best results, the conduit should be grounded at both ends. As a general rule, the conduit is automatically grounded at the transmitter because it screws into the transmitter housing, which should be grounded. Ensuring the conduit is also grounded at the accelerometer end (and at points along the conduit run) reduces coupling of the interfering energy into the cable and propagating it along the cable into the accelerometer.

[Figure 6-2](#) shows how to run the accelerometer through a conduit that is grounded on both ends. As a general rule, the transmitter housing itself is grounded through the base

where it is mounted. Since the conduit is electrically connected to the transmitter housing, this effectively grounds the conduit at the transmitter end.

Grounding the conduit at the accelerometer end as well significantly reduces the possibility that energy due to EMI/RFI can be coupled into the accelerometer cable. When employing this method, minimize the length of cable that is outside of the conduit by running the conduit as close as reasonably possible to the point where the accelerometer is mounted to the equipment being monitored.

Figure 6-2: Grounded conduit



6.2.3 Install ferrites

Note

The accelerometers are shipped with ferrites installed at the accelerometer end. To maintain the optimum performance of the accelerometer, do not remove the ferrites.

To meet the stated performance criteria, the standard accelerometer cable has two (2) ferrites installed. These are Steward ferrites (P/N 28B0355-000), with each providing 205 Ω of reactance at 100 MHz.

Figure 6-3: Standard accelerometer cable with ferrites installed (as shipped from the factory)



The armor-jacketed accelerometer cable has one ferrite installed. It is a Steward ferrite (P/N 28B0672-000), which provides 245 Ω of reactance at 100 MHz.

Figure 6-4: Armor-jacketed accelerometer cable with ferrite installed (as shipped from the factory)



If your cables require additional immunity after accelerometer installation is complete and accelerometer cables have been run through a conduit (if applicable), you can place additional ferrites on the other end of the cable.

Note

The performance of the accelerometer is not maintained beyond a 3-m (10-ft) cable-length unless you install additional ferrites.

All low-power sensors for use with the AMS 9420 are shipped with additional ferrites if their cable lengths exceed 3 meters. To ensure compliance with the CE directive, if the cable length exceeds 3 meters, all standard sensor configurations (1 accelerometer, 1 accelerometer with embedded temperature, or 2 accelerometers) require ferrite installation at the site.

These ferrites are not installed on the accelerometer cable at the factory because they must be installed on the transmitter end of the cable. To maintain compliance with the CE directive, sensors with cables longer than 3 meters must have 3 additional ferrites installed. You do not need to install the additional ferrites if the cable length is less than 3 meters.

From a compliance perspective, you do not need to install the ferrites if the cable is in a ferromagnetic conduit (such as galvanized steel) because this type of conduit provides additional shielding. Note that the conduit entry of the device is ½ inch NPT. If you install ferrites with a conduit, you will need a wider conduit (¾ inch NPT or M20) to accommodate the ferrites and an adapter is required at the conduit entry of the device.

The ferrites provided with the sensors that have standard (polyurethane) cables are Fair-Rite P/N 0431173951. These ferrites simply snap onto the cable near the point where the cable enters the transmitter housing. You can also use wire ties and/or heat-shrink with these ferrites.

The ferrites provided with the sensors that have armor-jacketed cables are Fair-Rite P/N 2631665702. These slide onto the cable and must have wire-ties and/or heat-shrink, or some similar mechanism, to hold them in place.

Figure 6-5: Transmitter, accelerometer with standard cable, and ferrites (pre-installation)



Figure 6-6: Armor-jacketed cable and ferrites (pre-installation)



Install ferrites on a standard cable

1. Make standard connections to the AMS 9420 terminal block and grounding screw.
2. Snap the first of three attenuator ferrites (MHM-94985) at the location on the cable approximately 1 in. from the point where the cable enters the gland.
3. Snap the second ferrite onto the cable adjacent to the first; then snap the remaining ferrite adjacent to the second.

Note

Apply adequate force in the ferrites' closures so that the keeper latches fully engage. This ensures that the ferrites remain securely fastened to the cable.

Figure 6-7: Ferrites installed on a standard cable



Install ferrites on an armor-jacketed cable

1. Slide the first of the three ferrites at the location on the cable approximately 1 in. from the point where the cable enters the gland.
2. Secure the ferrite using a wire tie, heat-shrink, or any other method approved for your location.
3. Slide the second and third ferrites onto the cable adjacent to the first, and secure them in place with a wire tie or heat-shrink.

Figure 6-8: Ferrites installed on an armor-jacketed cable



Install a ferrite on the external DC supply

You need an additional ferrite for devices that use external DC supply. The example in [Figure 6-9](#) shows a ferrite on the external DC supply and three ferrites on each sensor cable.

Figure 6-9: Ferrites installed on external DC supply and sensor cables



This is a snap-on ferrite. Depending on the size of the wire used, you might need to secure the ferrite in place.

An example is Fair-Rite P/N 0431164281, which has a reactance that ranges from 28 Ω at 1 MHz to 310 Ω at 100 MHz and 240 Ω at 250 MHz. It supports a maximum cable diameter of 0.260 inch (6.6 mm).

Effect of ferrites on interference

Figure 6-10 compares two accelerometers in the presence of a high-intensity RF field (10 V/m). The oscilloscope is the time-domain representation of the signals.

The upper trace (A) is a standard (non-armor-jacketed) 3-meter cable, without conduit, with polarization matching that of the interference field, and with two ferrites installed at the accelerometer end of the cable. The resulting interference is about 10 mV peak-to-peak, which is equivalent to a perturbation of about 0.2 g's peak to the acceleration measurement.

The lower trace (B) is a 3-meter cable of the same type, without conduit, with polarization matching that of the interference field. In this case there are no ferrites installed, and the resulting interference is about 1.2 V peak-to-peak, which is equivalent to a perturbation of about 24 g's peak to the acceleration measurement.

Figure 6-10: Accelerometer signals in the presence of high-intensity interference with and without mitigation*

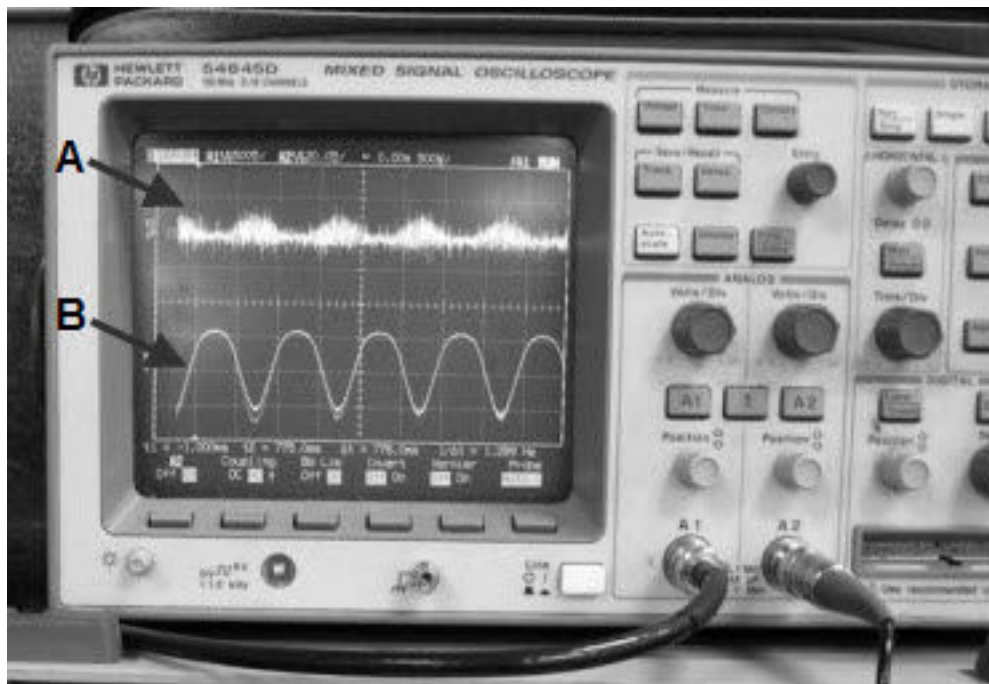

- A. With two ferrites installed
- B. Without ferrites installed

*Scale is not the same for A and B in this graph.

Figure 6-10 also shows that ferrites provide a huge amount of RFI suppression and are needed to maintain measurement integrity in the presence of strong electromagnetic interference. Do not remove the ferrites installed on the accelerometer cables that are shipped from the factory, even if you mitigate interference using other methods.

6.2.4 Reduce polarized interference

The maximum coupling onto the cable occurs when the polarization of the interfering signal matches the cable run. In most cases, intermittent interference sources, such as handheld two-way radios or tablet computers, are naturally vertically polarized because of the way we hold these items during normal usage. As a result, installations with long vertical runs of cable are more susceptible to EMI/RFI than horizontal runs of similar length.

[Figure 6-11](#) illustrates how to install cables to improve immunity against vertically polarized interference, and [Figure 6-12](#) illustrates cable installations that increase susceptibility to vertically polarized interference.

Figure 6-11: RFI source cross-polarized with long cable run (minimum interference)



Figure 6-12: RFI source polarization coincident with long cable run (maximum interference)



A Specifications and reference data

Topics:

- [A.1 Functional specifications](#)
- [A.2 Physical specifications](#)
- [A.3 Performance specifications](#)
- [A.4 Radio specifications](#)
- [A.5 Low-power sensor options](#)
- [A.6 Dimensional drawings](#)
- [A.7 Device variable index](#)

A.1 Functional specifications

Input	Supports 1 or 2 accelerometers, or 1 accelerometer with an embedded temperature sensor. See Low-power sensor options table for more information.
Output	Wireless-enabled, linear with temperature or input.
Local display	The optional five-digit integral LCD can display engineering units g's, m/s ² , in/s, mm/s, °F, and °C. It can also display updates at a transmit rate of up to once per minute.
Humidity limits	0–95% relative humidity
Transmit rate	User-selectable, 60 seconds to 1 hour for the 2.4 GHz CSI 9420.

Measurement	Range
	<u>RMS velocity (frequency dependent):</u> 0.008 in/s to >4.35 in/s (0.20 mm/s to >110.5 mm/s)
	<u>PeakVue:</u> 0.02 g to 80 g (0.2 m/s ² to 785 m/s ²)
	<u>PeakVue details:</u> 51.2 kHz sampling rate, 4096 samples/block, 1000 Hz high pass filter
	Accuracy
	<u>For vibration over stated frequency response (at room temperature)</u>
	RMS velocity:
	<ul style="list-style-type: none">• +/- 5% from 10 Hz to 800 Hz• (3.0 dB) from 2 Hz to 1000 Hz
	PeakVue:
	<ul style="list-style-type: none">• +/- 5% from 2000 Hz to 10 kHz• (3.0 dB) from 1000 Hz to 25 kHz
	<u>Temperature</u>
	<ul style="list-style-type: none">• +/- 2°C
	<u>Sensor variability (vibration)</u>
	<ul style="list-style-type: none">• Temperature coefficient: 0.1% per °F; 0.18% per °C (2 dB, worst case)• EMI/transient susceptibility (2.4 GHz only): +/- 15% (1.2 dB) under worst-case interference conditions (per EN 61326)• 3 dB up to 10 kHz; 10 dB up to 25 kHz
	<u>Sensor variability (temperature)</u>
	EMI/transient susceptibility of the temperature measurement is unspecified, since this is not the primary purpose of the device. Testing has demonstrated that high-intensity RF fields have the potential to render the temperature measurement meaningless.
	Measurement precision
	Measurement precision refers to the variability of the same measurement in a fixed operating environment under steady-state conditions. For vibration, this value is obtained with statistical measurements with 1 g-peak (9.81 m/s ²) input excitation at a frequency of 100 Hz. For temperature, this value is obtained with statistical measurements at room temperature.
	<ul style="list-style-type: none">• Vibration: 0.2 dB• Temperature: +/- 2°C

A.2 Physical specifications

Electrical connections/power module

Smart Power Module

- Replaceable, non-rechargeable, intrinsically safe lithium-thionyl chloride power module pack with PBT enclosure
- 1.5–5-year power module life at reference conditions¹
- 4 screw terminals for sensor connection

External DC power with the Emerson A9000P series adapters

- 11-28 VDC, 40 mA, 80 mA peak
- 22 gauge wire minimum

Field Communicator connections

- Communication terminals
- Clips permanently attached to the terminal block

Construction materials

- Enclosure housing – Low-copper aluminum²
- Paint – Polyurethane
- Cover O-ring – Buna-N
- Terminal block and power module pack – PBT
- Antenna – PBT/PC integrated omnidirectional antenna

Mounting

Transmitter mounting requires mounting brackets. See the [Dimensional Drawings](#) for more information.

Weight

AMS 9420 without LCD – 4.6 lb (2 kg)

AMS 9420 with M5 LCD – 4.7 lb (2.1 kg)

Enclosure ratings

Housing is NEMA 4X and IP66 with approved cable glands

¹ Reference conditions are 70 °F (21 °C), two accelerometers with a transmit rate of once every 60 minutes, and routing data for three additional network devices, LCD disabled, no time-based collection of energy band.

² The housing is also available in non-polished stainless steel. Contact an Emerson sales representative for more information.

A.3 Performance specifications

Temperature Limits

The transmitter will operate within specifications for ambient temperatures between –40°F and 185°F (–40°C and 85°C).

Table A-1: Temperature limits

AMS 9420	Operating limit	Storage limit
With LCD display	–4°F to 175°F –20°C to 80°C	–40°F to 185°F –40°C to 85°C
Without LCD display	–40°F to 185°F –40°C to 85°C	–40°F to 185°F –40°C to 85°C

Electromagnetic compatibility (EMC)

The 2.4 GHz AMS 9420 meets all requirements listed under IEC 61326:2006.

A.4 Radio specifications

Parameter	Min	Typical	Max	Units	Comments
Operating frequency	2.4000	-	2.4835	GHz	-
Number of channels	-	15	-	-	-
Channel separation	-	5	-	MHz	-
Occupied channel bandwidth	-	2.7	-	MHz	at -20 dBc
Frequency accuracy	-50	-	+50	kHz	-
Modulation	-	-	-	-	IEEE 802.15.4 DSSS
Raw data rate	-	250	-	kps	-
Received operating maximum input level	-	0	-	dBm	-
Receiver sensitivity	-	-92.5	-	dBm	At 50% PER $V_{DD} = V$, 25°C
	-	-90	-	dBm	At 1% PER, $V_{DD} = 3 V$, 25°C (inferred from 50% PER measurement)
Output power, conducted	-	+8	-	dBm	$V_{DD} = 3 V$, 25°C Long Range Antenna
	-	+12.5	-	dBm	$V_{DD} = 3 V$, 25°C Extended Range Antenna

A.5 Low-power sensor options

Table A-2: Standard order models

Part number	Color code	Cable length (ft) ¹	Cable type	Sensor range
Accelerometer				
A0394RI-1	Green	30	Polyurethane	0.02 g to 80 g from 1 kHz to 20 kHz 0.01 in/s to 4.35 in/s at 1 kHz
A0394RI-4		95		
A0394RA-1		30	Armor	
A0394RA-4		95		

Table A-3: Special order models

Part number	Color code	Cable length (ft) ¹	Cable type	Sensor range
Accelerometer				
A0394RI	Green	10	Polyurethane	0.02 g to 80 g from 1 kHz to 20 kHz 0.01 in/s to 4.35 in/s at 1 kHz
A0394RI-2		50		
A0394RA		10	Armor	
A0394RA-2		50		
A0394RAC		10	Armor w/ Teflon coating	
A0394RAC-1		30		
A0394RAC-2		50		
A0394RAC-4		95		
Dual output sensor (Accelerometer and temperature)				
A0394DI	Blue	10	Polyurethane	0.02 g to 80 g from 1 kHz to 20 kHz 0.01 in/s to 4.35 in/s at 1 kHz -40°C to 125°C
A0394DI-1		30		
A0394DI-2		50		
A0394DI-4		95		
A0394DA		10	Armor	
A0394DA-1		30		
A0394DA-2		50		
A0394DA-4		95		
A0394DAC		10	Armor w/ Teflon coating	
A0394DAC-1		30		
A0394DAC-2		50		
A0394DAC-4		95		

¹ The AMS 9420 is not approved for use with a cable that is 30 m (100 ft) or longer. The recommended maximum cable length is 29 m (95 ft). Shorter is better.

A.6 Dimensional drawings

Sensors are specified separately.

Dimensions are in inches (millimeters).

Figure A-1: AMS 9420 with sensor and mounting brackets

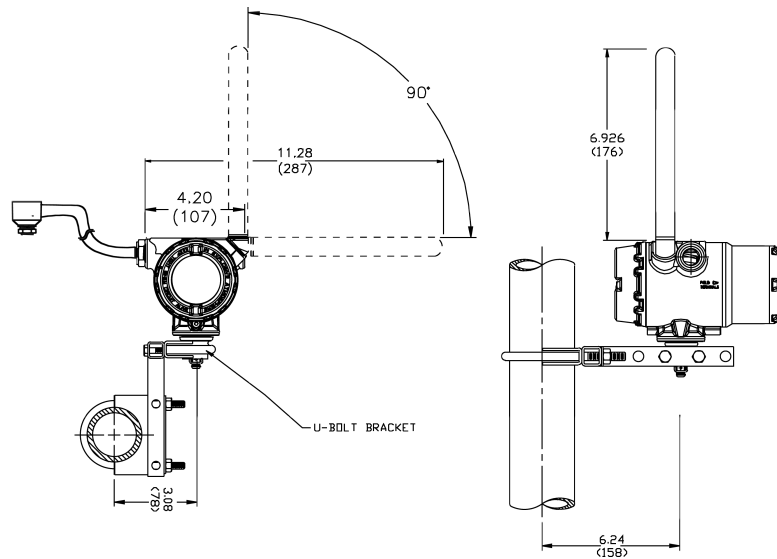

Figure A-2: AMS 9420 with long-range and extended antennas

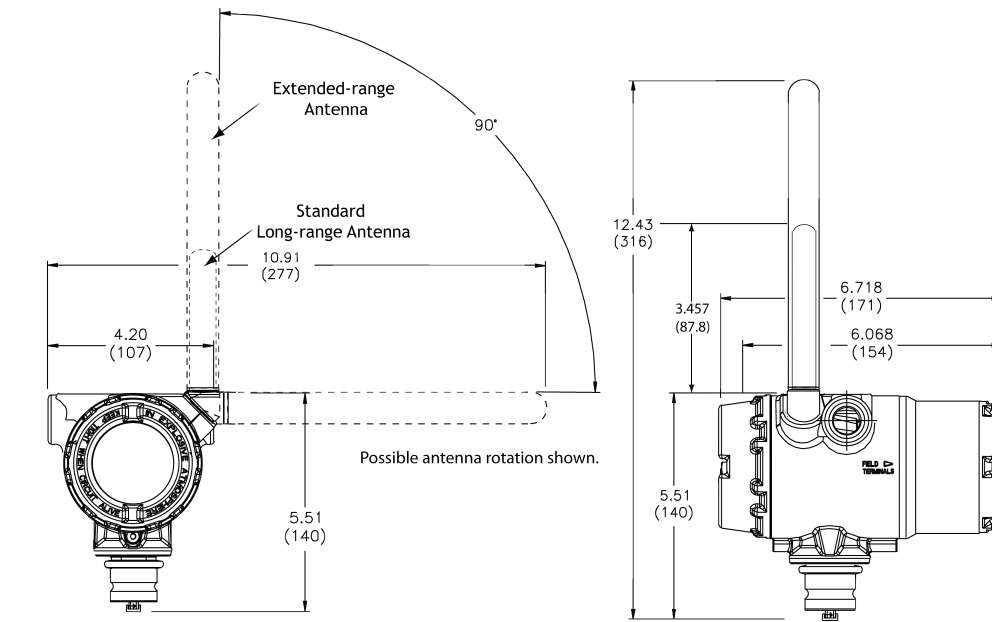
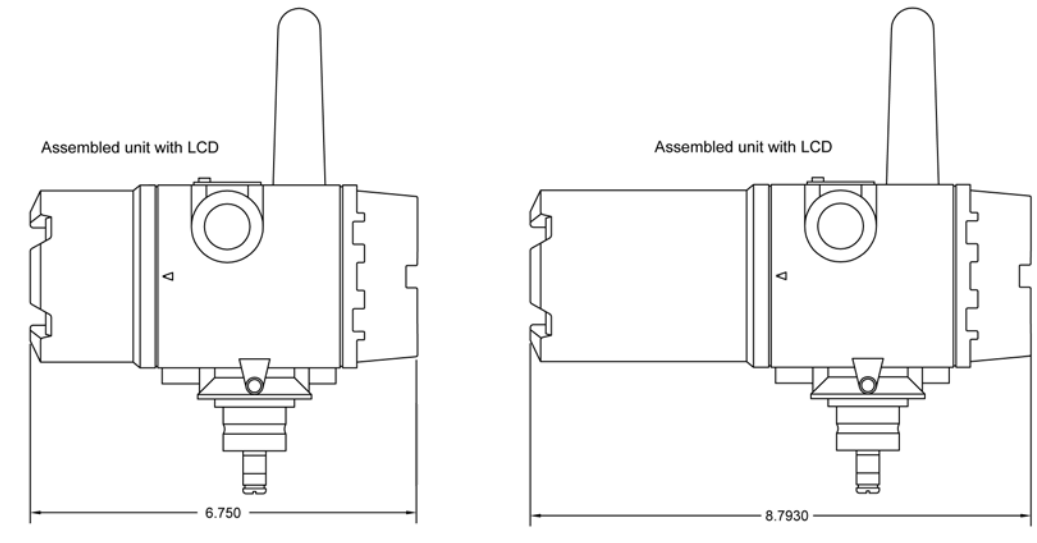

Figure A-3: AMS 9420 with LCD and standard end cap (left) or extended end cap (right)



A.7 Device variable index

Device variable index	Description	Application
0	SUPPLY_VOLTAGE	All Units
1	BOARD_TEMP	
2	OVERALL_1	
3	PEAKVUE_1	
4	BIAS_1	
5	OVERALL_2	Units with 2 Accelerometers
6	PEAKVUE_2	
7	BIAS_2	
8	EXTERN_TEMP	Units with Dual Output Sensor

B Product certifications

Topics:

- [B.1 Approved manufacturing locations](#)
- [B.2 Wireless certifications](#)
- [B.3 Ordinary location certification \(CSA\)](#)
- [B.4 CE mark](#)
- [B.5 Hazardous locations certifications](#)
- [B.6 RoHS 2 \(2011/65/EU\)](#)

Note

For specific device certifications, always refer to the product nameplate and markings on the device.

B.1 Approved manufacturing locations

Emerson
835 Innovation Drive
Knoxville, TN 37932 USA
T: +1 865-675-2400

Benchmark Electronics (Thailand) Plc.
109 moo.4, Chaimongkol, Muang, Nakorn Ratchasima
Thailand 30000
T: +66 44-233-800

B.2 Wireless certifications

Telecommunications compliance

All wireless devices require certification to ensure that they adhere to regulations regarding the use of the RF spectrum. Nearly every country requires this type of product certification. Emerson works with governmental agencies around the world to supply fully compliant products and remove the risk of violating country directives or laws governing wireless device usage.

Radio Equipment Directive (2014/53/EU)

Emerson complies with the Radio and Equipment Directive.

FCC and IC approvals

This device complies with Part 15 of the FCC Rules. Operation is subject to the following conditions:

- This device may not cause harmful interference.
- This device must accept any interference received, including interference that may cause undesired operation.

- This device must be installed to ensure a minimum antenna separation distance of 20 cm from all persons.

Telecommunication compliance

2.4 GHz CSI 9420

FCC ID: LW2RM2510

IC ID: 2731A-RM2510

B.3 Ordinary location certification (CSA)

As standard, the transmitter has been examined and tested to determine that the design meets basic electrical, mechanical, and fire protection requirements by CSA, a nationally recognized testing laboratory (NRTL) as accredited by the Federal Occupational Safety and Health Administration (OSHA).

Electromagnetic Compatibility (EMC) (2014/30/EU)

All Models: EN 61326-1

Canadian Standards Association (CSA)

CAN/CSA-C22.2 No. 61010-1-12 - Safety Requirements for Electrical Equipment for Measurement, Control, and Laboratory Use, Part 1: General Requirements

ISA S82.02.01 2nd (IEC 61010-1 Mod) - Safety Standards for Electrical and Electronic Test, Measuring, Controlling and Related Equipment - General Requirements

UL 61010-1 3rd - Safety Requirements for Electrical Equipment for Measurements, Control, and Laboratory Use, Part 1: General Requirements

B.4 CE mark





The 2.4 GHz version of the device has been tested and complies with all relevant directives required for CE marking.



Country	Restriction
Bulgaria	General authorization required for outdoor use and public service.
Italy	If used outside of own premises, general authorization is required.
Norway	May be restricted in the geographical area within a radius of 10 km from the center of Ny-Alesund.
Romania	Use on a secondary basis. Individual license is required.

B.5 Hazardous locations certifications

Table B-1: AMS 9420 hazardous locations certifications

USA/Canada 	Certificate	CSA 12CA2493476X
	Marking	Class I Division 1 Groups C & D Class I Zone 0 Group IIB Ex/AEx ia IIB T4 -40 °C ≤ Ta ≤ 85 °C, -20 °C ≤ Ta ≤ 80 °C w/LCD
		Class I Division 2 Groups A,B,C & D Class I Zone 2 AEx ic IIC Gc Ex ic IIC Gc T4 (135 °C), -40 °C ≤ Ta ≤ 85 °C, -20 °C ≤ Ta ≤ 80 °C w/LCD; Type 4X Enclosure
Standards	CAN/CSA C22.2 No. 0-M91 CAN/CSA C22.2 No. 94-M91 CSA Std. C22.2 No. 142-M1987 CAN/CSA C22.2 No. 157-92 CSA Std. C22.2 No. 2130-M1987 CAN/CSA C22.2 No. 60079-0:11 CAN/CSA C22.2 No. 60079-11: UL 50:2007 UL 913:7 th Ed. UL 916:2007 ANSI/UL 60079-0:2009 ANSI/UL 60079-11:2009	
Europe 	Certificate	Sira 16ATEX2148X Sira 15ATEX4237X
	Marking	 II 1 G Ex ia IIB T4 Ga -40 °C ≤ Ta ≤ 85 °C, -20 °C ≤ Ta ≤ 80 °C w/LCD Zone 0 Group IIB
		 II 3 G Ex ic IIC T4 Gc T4 (135 °C), -40 °C ≤ Ta ≤ 85 °C, -20 °C ≤ Ta ≤ 80 °C w/LCD Zone 2 Group IIC
Standards	EN 60079-0:2012/A11:2013 EN 60079-11:2012	
International 	Certificate	IECEX CSA 12.0014X
	Marking	Ex ia IIB T4 Ga Ex ic IIC T4 Gc Ta: -40 °C to +85 °C Ta: -20 °C to +80 °C
	Standards	IECEx 60079-0:2011 Edition 6.0 IECEx 60079-11:2011 Edition 6.0

⚠ WARNING

POTENTIAL STATIC CHARGING HAZARD—DO NOT RUB OR CLEAN ANTENNA WITH A DRY CLOTH.

Special conditions for safe use:

- The antenna may present a potential electrostatic ignition hazard and shall not be rubbed or cleaned with a dry cloth.
- The apparatus may be equipped with an aluminum alloy or stainless-steel enclosure. The aluminum alloy enclosure has a protective polyurethane paint finish; however, care should be taken to protect it from impact or abrasion.
- Intrinsically Safe when installed per drawing D25418.
- The battery pack may present a potential electrostatic ignition hazard. Use caution when replacing battery pack.

Other approvals

The AMS 9420 carries multiple certificates for operation in hazardous locations. For a complete listing of approvals, see <http://www.emerson.com/en-us/catalog/ams-a9420>.

Note

The markings that appear on the transmitter housing determine whether a device is suitable for operation in a specific hazardous location. This further requires that the transmitter is being operated in accordance with the installation drawings provided with the unit.

B.6 RoHS 2 (2011/65/EU)





The AMS 9420 was designed for incorporation into large, fixed industrial installations. Examples include - but are not limited to - cooling towers and other cooling systems, pumping systems, compressor systems, and systems utilizing agitators or centrifuges. As such, the AMS 9420 is covered under the exclusion provided for Large Scale Fixed Installations and is therefore out of scope for the current EU RoHS Directive 2011/65/EU.



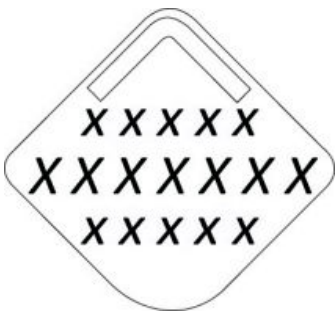

Please contact Emerson's Reliability Solutions office at +1-865-672-1062 with any questions or concerns.

C LCD screen messages

Startup screen sequence

These are the screens when the power module is first connected to the AMS 9420.



LCD screen	Meaning	Description
	All Segments On	Used to visually determine if there are any bad segments on the LCD.
	NIM Startup	The device is waiting for the radio to initialize. This takes approximately 15 seconds.
	Device Name	Used to determine the device name.
	Acquire Preparation	The device powers up the DSP and prepares for data acquisition.

LCD screen	Meaning	Description
 <p>ACQ DATA</p>	Acquire Data	The device is acquiring and processing data.
 <p>ABCDE FGHI</p>	Device Information Tag	8-character user entered tag.
 <p>ID-12 345678</p>	Device Identification	Device identifier that makes up the HART long address. The Smart Wireless Gateway may use this to help identify devices if no unique user tag is available.
 <p>NETWK 221 ID</p>	Network Identification	This ID tells the user what network the device can connect to, assuming the device has the correct Join Key.

LCD screen	Meaning	Description
	Version Code	Displays the firmware version of the device.

Joining and provisioning



These are the screens when the AMS 9420 is in the process of joining the network.





LCD screen	Meaning	Description
	Service Created	The request for network services has been granted to the device. Services must be obtained before the device can transfer data through the network.
	Service Delayed	The request for network services is pending.
	Set Service	The request for network services has been issued to the device.

LCD screen	Meaning	Description
	Service Rejected	The request for network services has been rejected by the network manager. Sufficient bandwidth may not currently be available.

Normal operating sequence

These are the screens displayed during normal operation.



LCD screen	Meaning	Description
	Network Operational	The device is connected to both the network manager and the gateway. It is ready to send data.
	Acquire Preparation	The device powers up the DSP and prepares for data acquisition.
	Acquire Data	The device is acquiring and processing data.





LCD screen	Meaning	Description
	PV screen	Displays the overall velocity, PeakVue, temperature, sensor bias voltage, or power supply voltage depending on how the device is configured.
	SV screen	Displays the overall velocity, PeakVue, temperature, sensor bias voltage, or power supply voltage depending on how the device is configured.
	TV screen	Displays the overall velocity, PeakVue, temperature, sensor bias voltage, or power supply voltage depending on how the device is configured.
	QV screen	Displays the overall velocity, PeakVue, temperature, sensor bias voltage, or power supply voltage depending on how the device is configured.
	Data Publish	The device has started collecting new data and will publish it to the gateway when complete.

LCD screen	Meaning	Description
	Sleep	Shows how long the device sleeps between times it wakes up and collects/publishes data.

Network status screens





These screens display the network status of the AMS 9420.

LCD screen	Meaning	Description
	Network Unknown	The device has yet to retrieve information from the Smart Wireless Gateway and is still in the process of being activated.
	Network Idle	The device is in a low power idle state and it is not connected to the network.
	Network Search	The device is searching for a network.

LCD screen	Meaning	Description
	Network Negotiation	The device has detected a network and is attempting to establish connection.
	Network Connected	The device has joined the network and has established connection with the network manager.
	Network Operational	The device is connected to both the network manager and the gateway. It is ready to send data.
	Network Disconnected	The device is disconnected from the network.

Device diagnostic screens

These screens show the state of the AMS 9420.

LCD screen	Meaning	Description
	Device Failure	There is critical error which may prevent the device from operating correctly.
	Alert Present	At least one alert is present.
	Low Supply Voltage	The terminal voltage is below the recommended operating range. If the device is power module operated, the power module should be replaced. If the device is line-powered, the supply voltage should be increased.
	Supply Failure	The terminal voltage has reached a critical level. If the device is power module operated, the power module should be replaced. If the device is line-powered, the supply voltage should be increased.
	More Status Available	At least one device parameter is on alert.

Index

A

- absolute temperature monitoring 123
- accelerometer cable length 127
- accelerometer EMI and RFI considerations 125
- acquisitions
 - publishing policy 105
 - store on alert 105
 - time-based storage 105
- Advanced Diagnostics application
 - alternative installation 105
 - enable using AMS Device Manager 103
 - enable using AMS Wireless Configurator 103
 - enable using field communicator 105
 - enable using HART modem 105
 - standard installation 103
- alert levels 55
- alert thresholds, default 55
- ambient temperature 122
- AMS Device Manager
 - Advanced Diagnostics application 78
 - configure alert limits 83
 - configure publishing 83
 - configure sensors 78
 - configure units 83
 - Configure window 83
 - configuring wireless network credentials 76
 - device revision 78
 - effective acquisition rate 83
 - guided setup 83
 - join device to network 78
 - manual setup 83
 - MHM Access Control 78
 - Overview window 78
 - restore factory default settings 92
 - right-click menu 77
 - sensor power enable 83
 - Service Tools window 92
 - spectra 92
 - trends 92
- AMS Machinery Manager
 - Advanced Diagnostics application 101
 - configuration with 101
 - data collection 105
 - Data Import 105
 - publishing policy 105
 - Store on Alert 105
- antenna dimensional drawings 143
- antenna position 39, 40
- Asset Control
 - AMS Device Manager 105
 - AMS Machinery Manager 105
- attaching sensors 18

C

- cable entry port installation guidelines 24
- cable length 127
- CE marking 146
- commissioning 11
- conductive conduit, using 127
- conduit installation guidelines 23
- configuration options 52
- configuration with AMS Machinery Manager 101
- configuration with field communicator 60, 61, 74
- configuring wireless network credentials, AMS Device Manager 76
- construction materials, transmitter 140

D

- data collection
 - AMS 9420 105, 106
 - AMS Machinery Manager 105
 - Emerson Wireless Gateway 105, 106
- Data Import 105
- Data Import Client 106
- DC power 11
- default alert thresholds 55
- default configurations 52
- device revisions 7
- dimensional drawings 143

E

- electromagnetic compatibility 141
- EMI and RFI considerations 125
- enabling LCD 43
- enclosure rating 140
- Energy Band trends 111
- environmental considerations 11
- epoxy mount 18
- Extended Life Smart Power Module
 - removing 60

F

- fast key sequences, field communicator 74
- features, transmitter 7
- ferrites 129
- ferrites, installing 129
- field communicator fast key sequences 74
- field communicator menu tree 60, 61
- field communicator, configuration with 60, 61
- functional specifications 138

G

grounding 45

H

hazardous location certificates 147

I

import data
 AMS 9420 105, 106
 Emerson Wireless Gateway 105, 106
installation location 11
installing ferrites 129
interference, mitigating 127

L

LCD
 enabling 43
 installing 42
 power consumption 58
 screens, meaning 149
 turning on 44
LCD network status screens 112
LCD screen messages 149
low-power sensors 142

M

maintenance 92
manufacturing location 145
minimizing power consumption 58
mitigating interference
 installing ferrites 129
 reducing polarized interference 136
 summary 125
 using a conductive conduit 127
 using shorter cables 127
mount the device 14
mounting tools, sensor 16

O

operating limit, sensors 14
ordinary location certification 146
overall velocity 115
overview 7
overview, transmitter 7

P

parameter units 55
parameters, trending 59

PeakVue 118
performance specifications 141
physical specifications 140
power consumption, minimizing 58
power module
 environmental considerations 30
 handling 30
 maintenance 30
 removal 60
 replacement 30
 shipping 30
power module life 105, 106
PowerSave mode 58
PowerSave Skip Multiplier 58
prepare sensor mount 17
preparing the sensor mount
 epoxy mount 18
 stud mount 17
product support 12
publishing mode
 generic mode 57
 optimized mode 57
publishing policy 105, 106

R

radio specifications 141
reducing polarized interference 136
relative temperature monitoring 123
removing the power module 60
restore factory default settings 92
return of materials 12
revisions, device 7
RoHS 148
rotating LCD 42

S

safety messages 6
securing sensor cables 22
sensor and mounting bracket drawings 143
sensor cabling 22
sensor configuration 53
sensor mount, preparing 17
sensor mounting/attachment tools 16
sensor operating limits 14
sensor sensitivity 53
sensors
 attaching 18
 cable length 127
 mounting tools 16
 operating limit 14
 special order 142
 standard 142
Smart Power Module 11
spectral data 92

spectrum time 111
Store on Alert 105
stud mount 17

T

temperature
 absolute monitoring 123
 alert thresholds 123
 limits 11
 relative monitoring 123
temperature limits 11
trending Energy Band parameters 111
trending of parameters 59
trends 92
turning on the LCD 44

U

units 55
update rate 58

V

variable mappings 53
verifying status and operation 112

W

waveform 111
weight, transmitter 140
wire the device 27
wireless certifications 145

Emerson

835 Innovation Drive
Knoxville, TN 37932 USA
T +1 865-675-2400
F +1 865-218-1401
www.Emerson.com

©2020, Emerson.

The contents of this publication are presented for informational purposes only, and while every effort has been made to ensure their accuracy, they are not to be construed as warranties or guarantees, express or implied, regarding the products or services described herein or their use or applicability. All sales are governed by our terms and conditions, which are available on request. We reserve the right to modify or improve the designs or specifications of our products at any time without notice.

All rights reserved. AMS is a mark of one of the Emerson group of companies. The Emerson logo is a trademark and service mark of Emerson Electric Co. All other marks are the property of their respective owners.

