

# 375

## FIELD COMMUNICATOR

## USER'S MANUAL





## **375 FIELD COMMUNICATOR**

### **NOTICE**

Read this User's Manual before working with the 375 Field Communicator. For personal and system safety, and for optimum product performance, thoroughly understand the contents before using or servicing this product.

For equipment service needs, contact the nearest product representative.

© 2009 Emerson Process Management. All rights reserved.

*The Emerson logo is a trademark and service mark of Emerson Electric Co.*

*AMS Suite is a registered trademark of Emerson Electric Co.*

*Rosemount and SMART FAMILY are registered trademarks of Rosemount Inc.*

*Windows is a registered trademark of Microsoft Corporation in the United States and other countries.*

*IrDA is a registered trademark of the Infrared Data Association.*

*FOUNDATION is a trademark of the Fieldbus Foundation.*

*HART is a registered trademark of the HART Communication Foundation.*

*WirelessHART is a trademark of the HART Communication Foundation.*

*Hitachi is a registered trademark of Hitachi America, Ltd.*

*All other marks are the property of their respective owners.*

*US and foreign patent numbers are pending.*



## TABLE OF CONTENTS

### SECTION 1

#### Introduction

Using this Manual .....	1-1
-------------------------	-----

### SECTION 2

#### Learning the Basics

Overview .....	2-1
----------------	-----

Safety Messages .....	2-1
-----------------------	-----

Product Overview and Precautions .....	2-2
--	-----

375 Field Communicator Components .....	2-2
---	-----

Working in an Intrinsically Safe (IS) Area .....	2-3
--	-----

Battery and Power Supply/Charger Overview .....	2-4
---	-----

Guidelines and Precautions .....	2-4
----------------------------------	-----

Check the Charge Remaining .....	2-5
----------------------------------	-----

Charge the Battery .....	2-5
--------------------------	-----

Maintaining the Battery Life and Performance .....	2-7
--	-----

Installing the System Card and the Battery .....	2-8
--	-----

Removing the Battery and the System Card .....	2-9
--	-----

Starting Up and Shutting Down .....	2-9
-------------------------------------	-----

Starting the 375 Field Communicator .....	2-9
---	-----

Entering Stand-By .....	2-10
-------------------------	------

Shutting Down the 375 Field Communicator .....	2-10
--	------

Basic Features and Functions .....	2-11
------------------------------------	------

Using the Keypad .....	2-12
------------------------	------

Using the Touch Screen .....	2-14
------------------------------	------

The 375 Main Menu .....	2-15
-------------------------	------

Starting the HART Application .....	2-15
-------------------------------------	------

Starting the Fieldbus Application .....	2-15
---	------

Running the Settings Menu .....	2-15
---------------------------------	------

Communicating with a PC .....	2-21
-------------------------------	------

Using ScratchPad .....	2-24
------------------------	------

Managing Storage .....	2-27
------------------------	------

Types of Storage .....	2-27
------------------------	------

Free Memory on a System Card .....	2-28
<b>Maintenance</b> .....	<b>2-28</b>
Running a Self Test .....	2-28
Calibrating .....	2-29
<b>Waste Disposal</b> .....	<b>2-29</b>
<b>Hazardous Substances</b> .....	<b>2-29</b>

## **SECTION 3**

### **HART Functionality**

<b>Overview</b> .....	<b>3-1</b>
<b>Safety Messages</b> .....	<b>3-1</b>
<b>Basic Features and Functions</b> .....	<b>3-2</b>
<b>Using a Fast Key Sequence</b> .....	<b>3-2</b>
<b>Starting the HART Application</b> .....	<b>3-2</b>
<b>Working Offline</b> .....	<b>3-3</b>
Creating New Configurations .....	3-3
Opening Saved Configurations .....	3-4
<b>Working Online</b> .....	<b>3-8</b>
Connecting to a HART Loop .....	3-8
Displaying the Online Menu .....	3-11
Saving an Online Device Configuration .....	3-12
Displaying the Device Setup Submenu .....	3-12
Displaying Graphics .....	3-14
<b>Using Hot Keys</b> .....	<b>3-15</b>
Setting up Hot Key Options .....	3-15
Executing a Hot Key Option .....	3-16
Removing a Hot Key Option .....	3-16
Removing all Hot Key Options .....	3-16
<b>Configuring the HART Application</b> .....	<b>3-17</b>
Changing the HART Polling Option .....	3-17
Changing Ignored Status Messages .....	3-19
Changing the Menu Title .....	3-19
Storage Cleanup .....	3-20
Viewing Available Device Descriptions .....	3-20
Simulating an Online Connection to a HART Device .....	3-21
<b>Running HART Diagnostics</b> .....	<b>3-22</b>
DC Voltage Measurement (HART Terminals) .....	3-22
<b>Disconnecting from a HART Device</b> .....	<b>3-22</b>

## SECTION 4

### Fieldbus Functionality

<b>Overview</b> .....	<b>4-1</b>
<b>Safety Messages</b> .....	<b>4-1</b>
<b>Basic Features and Functions</b> .....	<b>4-2</b>
Link Active Scheduler (LAS) .....	4-2
LAS Hierarchy .....	4-3
Device Interoperability .....	4-3
ST_REV .....	4-3
<b>Starting the Fieldbus Application</b> .....	<b>4-4</b>
<b>Working Online</b> .....	<b>4-5</b>
Connecting to a Fieldbus Segment .....	4-5
Displaying the Live Device List .....	4-9
Displaying the Block List .....	4-10
Displaying a device menu .....	4-10
Modes .....	4-11
Working with Device Blocks .....	4-14
Displaying Graphics .....	4-20
<b>Configuring the Fieldbus Application</b> .....	<b>4-21</b>
Changing the Fieldbus Polling Addresses .....	4-21
Changing the Slot Time .....	4-21
Viewing Available Device Descriptions .....	4-22
<b>Running Fieldbus Diagnostics</b> .....	<b>4-23</b>
DC Voltage and Noise Level Measurement .....	4-23
Signal Level Measurement .....	4-23
<b>Disconnecting from a Fieldbus Device</b> .....	<b>4-24</b>

## SECTION 5

### Troubleshooting

<b>Overview</b> .....	<b>5-1</b>
Troubleshooting Suggestions .....	5-1
<b>Error and Status Messages</b> .....	<b>5-6</b>
<b>Required Information for Technical Assistance</b> .....	<b>5-10</b>

## APPENDIX A

### Reference Information

<b>Processor and Memory Specifications</b> .....	<b>A-1</b>
Microprocessor .....	A-1
Memory .....	A-1
<b>Physical Specifications</b> .....	<b>A-2</b>
<b>Connection Specifications</b> .....	<b>A-2</b>

<b>Power Supply/Charger Specifications</b> .....	<b>A-3</b>
<b>Battery Specifications</b> .....	<b>A-4</b>
<b>Temperature Specifications</b> .....	<b>A-4</b>
<b>Order Information</b> .....	<b>A-5</b>
<b>Spare Parts List</b> .....	<b>A-7</b>

## **APPENDIX B**

### **Product Certifications**

<b>Overview</b> .....	<b>B-1</b>
<b>Approved Manufacturing Locations</b> .....	<b>B-1</b>
<b>European Directive Information</b> .....	<b>B-1</b>
<b>Hazardous Locations Certifications (KL option only)</b> .....	<b>B-2</b>
International Certifications .....	B-2
North American Certifications .....	B-2
European Certifications .....	B-3
<b>Power Supply/Charger Certification</b> .....	<b>B-4</b>
<b>Label Drawings</b> .....	<b>B-4</b>
<b>Approval Drawings</b> .....	<b>B-7</b>

## **APPENDIX C**

### **Graphics Information**

<b>Overview</b> .....	<b>C-1</b>
<b>Screen Layout</b> .....	<b>C-2</b>
<b>Buttons</b> .....	<b>C-3</b>
<b>Graphics Options</b> .....	<b>C-4</b>
Images .....	C-4
Charts .....	C-5
Graphs .....	C-10

<b>Glossary</b> .....	<b>G-i</b>
-----------------------	------------

<b>Index</b> .....	<b>I-1</b>
--------------------	------------



## SECTION 1 INTRODUCTION

### USING THIS MANUAL

The sections in this manual provide the following information on the 375 Field Communicator.

**Section 2: Learning the Basics** contains information on settings, types of storage, IrDA<sup>®</sup> communication, card readers, ScratchPad, maintenance, and managing files and storage.

**Section 3: HART Functionality** contains information on starting and configuring the HART<sup>®</sup> Application, establishing communication with connected HART devices, and viewing the menus.

**Section 4: Fieldbus Functionality** contains information on starting and configuring the Fieldbus Application, establishing communication with connected fieldbus devices, and viewing the menus.

**Section 5: Troubleshooting** provides solutions to the most common 375 Field Communicator operating problems.

**Appendix A: Reference Information** provides physical, functional, and performance specifications.

**Appendix B: Product Certifications** contains Hazardous Location Certifications, European directive information, and approval drawings.

**Appendix C: Graphics Information** contains an overview of the Graphics functionality and screen options in the 375 Field Communicator.



## SECTION 2 LEARNING THE BASICS

### OVERVIEW

This section provides instructions on basic features and functions of the 375 Field Communicator. It also provides information on starting, entering stand-by, shutting down, configuring, and maintaining the 375 Field Communicator. The functionality described in this section is based on system software version 2.5.

### SAFETY MESSAGES

Procedures and instructions in this section may require special precautions to ensure the safety of the personnel performing the operation. Information that raises potential safety issues is indicated by a warning symbol () . Refer to the following safety messages before performing an operation preceded by this symbol. See the Troubleshooting section for more warning messages.

#### IMPORTANT NOTICE

Ensure the battery and the 375 Field Communicator are properly aligned during assembly to prevent damage to the connector pins.

#### IMPORTANT NOTICE

Do not pull up on the battery because this can damage the connector pins. The System Card must be inserted or removed by applying gentle pressure in line with the axis of the System Card and the System Port. Do not pull up or press down on the System Card because this can damage the card or the communicator and void the warranty.

#### WARNING

A Re-Flash operation reinstalls the firmware and software from the System Card. This should only be performed under the direction of Technical Support personnel.

 **WARNING**

Using Windows Explorer and a card reader to transfer files between the System Card and a PC can corrupt the System Card. This operation should only be performed under the direction of Technical Support personnel.

 **WARNING**

The touch screen should be contacted by blunt items only, preferably the stylus included with the 375 Field Communicator. Using sharp instruments, such as screwdrivers, can cause failure of the touch-screen display and void the warranty. Repair of the touch screen requires replacement of the entire 375 Field Communicator display assembly, which is possible only at an authorized service center.

## **PRODUCT OVERVIEW AND PRECAUTIONS**

The 375 Field Communicator supports HART and FOUNDATION fieldbus devices, letting you configure or troubleshoot in the field. When using the 375 Field Communicator, follow all standards and procedures applicable to the location. Failure to comply may result in equipment damage and/or personal injury. Be sure to understand and comply with the following items:

### **375 Field Communicator Components**

- The 375 Field Communicator includes an FSTN type LCD with touch-screen display, a Nickel-Metal Hydride (NiMH) Battery Pack or Lithium Ion (Li-Ion) Power Module, an SH3 processor, memory components, and integral communication and measurement circuitry.
- Three terminals for the lead set are on the top of the 375 Field Communicator. The lead set and terminals let you connect the 375 Field Communicator to a device. Each red terminal is a positive connection for its protocol, while the black terminal is a common terminal shared by both protocols. An access door ensures only one pair of terminals is exposed at any one time. Several markings indicate which pair of terminals is for which protocol.
- The infrared port and card reader let the 375 Field Communicator or its System Card interface with a PC.
- Use the keypad or touch screen to enter data into the 375 Field Communicator.

- An Expansion Module, labeled Expansion Module, is a removable memory card that snaps into the Expansion Port.
- Only the Expansion Module or Expansion Port Plug should be inserted into the Expansion Port. System Cards/Secure Digital cards or other objects must not be put into the Expansion Port. Failure to comply will void the IS approval and the warranty.
- The System Card used in the System Port must be supplied by the 375 Field Communicator manufacturer. Failure to comply will void the IS approval and the warranty.

### **Working in an Intrinsicly Safe (IS) Area**

- An IS-approved 375 Field Communicator can be used in Zone 0 (FM and CSA only), Zone 1, or Zone 2, Division 1 and Division 2 locations (KL option only).
- An IS-approved 375 Field Communicator may be connected to loops or segments that are attached to equipment located in Zone 0, Zone 1, Zone 2, Zone 20, Zone 21, Zone 22, Division 1 and Division 2 (KL option only).
- The battery can be installed or removed in an Intrinsicly Safe area; however, it cannot be charged.
- The Expansion Module can be removed or installed in a hazardous area.
- The Expansion Module can be installed in an Intrinsicly Safe area while the 375 Field Communicator is still running.

## **BATTERY AND POWER SUPPLY/ CHARGER OVERVIEW**

The 375 Field Communicator supports two types of batteries: the NiMH Battery Pack and the Li-Ion Power Module. The NiMH Battery Pack has a black, 4-pin power supply/charger connector and the Li-Ion Power Module has a green, 6-pin connector. See Figure 2-3 on page 2-11 for the location of the connector. The label on the back of the battery also identifies the type.

---

### **NOTE**

The term “battery” is used to describe functionality common to both types of supported batteries. Any differences are noted.

---

## **Guidelines and Precautions**

Before using the battery or power supply/charger (00375-0003-0005), understand and follow the guidelines below:

- When transporting a Li-Ion Power Module, follow all applicable regulations.
- Use the power supply/charger with the 375 Field Communicator only. Use only the supported power supply/charger to charge the battery. Failure to comply may permanently damage your 375 Field Communicator and will void the IS approval and the warranty.
- Protect the battery and power supply/charger from moisture.
- Do not cover the battery or power supply/charger, subject it to direct sunlight, or place it on or next to heat-sensitive materials.
- Do not open or modify the battery or power supply/charger. There are no user-serviceable components or safety elements inside. Opening or modifying them will void the warranty.

## Check the Charge Remaining

Use the Power Status option in the Settings menu or the lights on the battery to view the remaining charge. See "Power Status" on page 2-18 for details.

To check the remaining charge from the lights on the battery:

1. Remove the battery if it is connected to the 375 Field Communicator. See "Removing the Battery and the System Card" on page 2-9 for the procedure.
2. Turn the battery over, and press the charge indicator button located on the lower left side. The lights illuminate based on the amount of charge remaining. Each light represents 20 percent of the charge remaining. The battery is fully charged when all of the lights are illuminated.

## Charge the Battery

---

### CAUTION

The previous 4-pin power supply/charger is incompatible with the 6-pin Li-Ion Power Module.

---

Prior to first portable use, fully charge the battery. The battery can be charged separately or while attached to the 375 Field Communicator. The 375 is fully operable when the battery is recharging. The power supply/charger can remain connected after the battery is fully charged. An overcharge condition will not occur.

The power supply/charger is compatible with both types of batteries. However, the NiMH Adapter Cable must be used with the power supply/charger to charge the NiMH Battery Pack. See Figure 2-1. The connector on the power supply/charger is green to match the appropriate connector on the Li-Ion Power Module or the NiMH Adapter Cable.

The lights on the power supply/charger are amber when charging, amber and green when the charge level is very low, green when charging completes, and red when charging cannot occur.

Figure 2-1. NiMH Adapter Cable used to charge the NiMH Battery Pack



---

**NOTE**

Do not charge the battery in hazardous areas.

---

To charge the battery:

1. Plug the power supply/charger into a power outlet.
2. Ensure the connectors match before connecting the power supply/charger to the battery.
3. Plug the power supply/charger connector into the battery. The battery is fully charged when the light on the power supply/charger is green.



## **Maintaining the Battery Life and Performance**

To maintain the battery life and performance, understand and follow the guidelines below:

### **Li-Ion Power Modules**

- Recharge the Power Module frequently, preferably after each use or at night. It is recommended to limit the number of full discharge and recharge cycles.
- Frequent use at high temperatures can reduce performance.
- Use a dry location at or near room temperature when storing the Power Module for an extended time. Prolonged storage at higher temperatures can reduce performance.
- Ensure the remaining charge level is at or near mid-capacity when storing for an extended time. The remaining charge will slowly drain during storage. Periodically charge the Power Module to ensure the remaining charge does not drain to low levels.

### **NiMH Battery Packs**

- Recharge the Battery Pack when it is nearly discharged. NiMH Battery Packs benefit from full discharge and recharge cycles.
- Use a dry, cool location when storing the Battery Pack for an extended time.
- Ensure the remaining charge level is nearly full when storing the Battery Pack. The remaining charge will slowly drain during storage. Periodically charge the Battery Pack to ensure the remaining charge does not drain to low levels.

## INSTALLING THE SYSTEM CARD AND THE BATTERY

1. Place the 375 Field Communicator face down on a level, secure surface.
2. Lock the stand into the hanger position. (To pivot past the stand position, squeeze the stand together near the hinge, Figure 2-2.)

Figure 2-2. Back side of the 375 Field Communicator

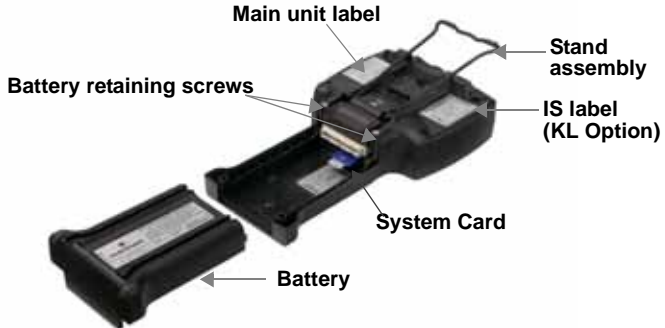

3. With the battery removed, slide the System Card (labeled System Card), into the System Port until it is firmly in place.
4. With the 375 Field Communicator still face down, ensure the tops of the two battery retaining screws are flush with the top of the 375. Install the battery by aligning the sides of the battery and the 375, and carefully sliding it forward until it is secure.
5. Carefully hand tighten the two battery retaining screws to secure the battery. (Do not over tighten, 0.5Nm maximum torque load.) The tops of the screws should be close to flush with the stand groove.

---



### CAUTION

If the battery and 375 are not properly aligned, the connector pins can be damaged.

---

## REMOVING THE BATTERY AND THE SYSTEM CARD

To remove the battery and System Card:

1. Place the 375 Field Communicator face down on a level, secure surface.
2. Loosen the battery retaining screws until the top of each screw is flush with the top of the 375 Field Communicator.
-  3. Slide the battery off the 375. Do not pull the battery up because this can damage the connector pins.
-  4. Grasp the System Card and slide it straight out of the 375. Do not pull the System Card up because this can damage the card or the System Port.

## STARTING UP AND SHUTTING DOWN

Prior to using the 375 Field Communicator without the power supply/charger, fully charge the battery. See “Battery and Power Supply/ Charger Overview” on page 2-4 for details on charging the battery.

Before operating the 375 Field Communicator, ensure:

- The 375 Field Communicator is not damaged.
- The battery is fully seated.
- All screws are sufficiently tightened.
- An Expansion Module or Expansion Port Plug is in place.
- The Communication Terminal recess is free of dirt and debris.

## Starting the 375 Field Communicator

Press and hold the On/Off key until the multifunction LED flashes (approximately two seconds). See Figure 2-3 for the location of the On/Off key.

During start-up, the 375 Field Communicator automatically checks for any software upgrades available on the System Card. You are notified if any upgrade is required.

After starting the 375 Field Communicator, you can do the following from the 375 Main Menu:

- Launch the HART or FOUNDATION Fieldbus Applications (if licensed)
- Configure and view settings
- Enter Listen For PC mode
- Launch ScratchPad

## Entering Stand-By

The 375 Field Communicator can be put into stand-by, which turns off the display and certain areas within the 375 Field Communicator. Use this option to save power or to reduce the boot-up time if you are using the 375 Field Communicator intermittently.

You can put the 375 Field Communicator in stand-by when the HART Application or the Fieldbus Application is running. If you are working online with a device when stand-by is entered, the application main menu is displayed when the 375 Field Communicator returns from stand-by. Otherwise, the 375 Field Communicator displays the last open screen.

To enter stand-by, press the On/Off key. From the Power Switch dialog box, tap **Stand by** and tap **OK** or press the Enter key. Tap **Cancel** to close the dialog box and return to the application. The multifunction LED will slowly flash a green light when the 375 Field Communicator is in stand-by. To leave stand-by, press the On/Off key.

The 375 Field Communicator also enters stand-by if the stand-by timer has expired. See “Power Status” on page 2-18 for more information.

## Shutting Down the 375 Field Communicator

To shut down the 375 Field Communicator, press the On/Off key. From the Power Switch dialog box, tap **Shut down** and tap **OK** or press the Enter key. Tap **Cancel** to close the dialog box and return to the application.

You can also shut down the 375 Field Communicator by simultaneously pressing the Backlight Adjustment key and the Function key until the display turns off. The shut down is accomplished in the hardware (similar to removing the power to a PC using a switch). This is not the recommended way of shutting off the 375 Field Communicator.

The 375 Field Communicator shuts down if the auto-off timer has expired. See “Power Status” on page 2-18 for more information.

## BASIC FEATURES AND FUNCTIONS

Figure 2-3. 375 Field Communicator diagram



## Using the Keypad

The 375 Field Communicator keypad and touch screen have nearly the same functionality.

### On/Off key

The On/Off key  is used to power on and off the 375 Field Communicator or to put it in stand-by. If the On/Off key is pressed when there is unsent data or a device method is running, a warning message appears. Tap **OK** to have the 375 Field Communicator enter stand-by or shut down, or tap **Cancel** to return to the previous screen.

The On/Off key is disabled when the 375 Field Communicator is in Listen For PC mode or when ScratchPad is open.

### Arrow Navigation keys

Four arrow navigation keys let you move through the menus in the applications. Press the right arrow key  to select menu items and to move into the menu.

### Enter key

The Enter key  lets you select the focused (highlighted) item or complete an editing action. For example, if you push the Enter key when the **Cancel** button on a screen is in focus, you will cancel out of that screen.

The Enter key does not let you launch menu items. Use the arrow navigation keys or the stylus to select and launch menu items.

### Tab key

The Tab key  lets you move between selectable controls.

## Alphanumeric keypad

The alphanumeric keypad lets you enter letters, digits, and other characters, such as punctuation marks. To enter text, press the desired keypad button in quick repetition to scroll through the options to achieve the appropriate letter or number. For example, to type the letter Z, press the 9 key quickly four times; see Figure 2-4.

Figure 2-4. Keypad button functionality example



## Backlight Adjustment key

The Backlight Adjustment key (🔆) lets you adjust the intensity of the display. There are four different settings. The intensity impacts the charge in the battery. Expect a shorter charge life for higher intensities; see “Backlight” on page 2-16 for the settings.

## Function key

The Function key (🔑) lets you enable alternate functionality on select keys. The grey characters on the keys indicate the alternate functionality. When the Function key is enabled, the orange Multifunction LED light appears and an indication button can be found on the Soft Input Panel (SIP). Press the Function key again to disable the functionality.

The alternate function on the Tab and alphanumeric 5 key (insert) will be activated in future releases of the 375 Field Communicator software.

## Multifunction LED

The Multifunction LED lets you recognize when the 375 Field Communicator is in various states; see Table 2-1.

Table 2-1. Multifunction LED

Multifunction LED	Meaning
Solid green	The 375 Field Communicator is on.
Flashing green	The 375 Field Communicator is in power saving mode (stand-by). The display is off.
Solid green and orange	The Function key is enabled.
Blinks green and orange	The On/Off key has been held down long enough for power up.



## Using the Touch Screen

The touch-screen display lets you select and enter text by touching the screen. Tap the screen once to select a menu item or to activate a control. Double-tap to move into the menu.

### NOTE

All instructions in this manual are written for the touch screen.

 The touch screen should be contacted by blunt items only, preferably the stylus included with the 375 Field Communicator. Using sharp instruments, such as screwdrivers, can cause failure of the touch-screen display. Repair of the touch screen requires replacement of the entire 375 Field Communicator display assembly, which is possible only at an authorized service center.

Use the back arrow icon () to return to the previous menu. Use the terminate icon () in the upper right corner of the touch screen to end the application.

## Use the Soft Input Panel (SIP) keyboard

The SIP keyboard allows for alphanumeric input using the touch screen. The SIP keyboard detects when you need to enter characters and appears automatically as required.



## THE 375 MAIN MENU

The 375 Main Menu lets you run the HART and the FOUNDATION Fieldbus Applications, view the Settings menu, communicate with a PC, and launch ScratchPad.

Figure 2-5. 375 Main Menu example

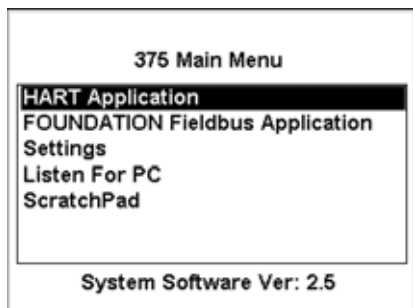

### Starting the HART Application

From the 375 Main Menu, double-tap **HART Application** to run the HART Application. On startup, the HART Application automatically polls for devices. See "Section 3 HART Functionality" for more information.

### Starting the Fieldbus Application

From the 375 Main Menu, double-tap **FOUNDATION Fieldbus Application** to run the Fieldbus Application. See "Section 4 Fieldbus Functionality" for more information.

### Running the Settings Menu

From the 375 Main Menu, double-tap **Settings** to view the Settings menu. This menu lets you set preferences for the 375 Field Communicator and view system properties and license information. The following section describes the options in the Settings menu.

## About 375

About 375 lets you view the software revisions of your 375 Field Communicator. If you need to call Technical Support personnel, have the system software version, Communication and Diagnostic Circuitry (CDC) version, and the operating system version available.

⚠ Launching RE-FLASH re-installs the firmware and software from the System Card. The 375 Field Communicator must be running on external power when the RE-FLASH operation is performed. During the operation, the stand-by and auto-off timers are disabled. This operation should only be performed under the direction of Technical Support personnel.

⚠ Launching RE-IMAGE re-installs the operating system, system software, and applications on your 375 Field Communicator. The 375 Field Communicator must be running on external power when the RE-IMAGE operation is performed. During the operation, the stand-by and auto-off timers are disabled. This operation should only be performed under the direction of Technical Support personnel.

Tap **OK** to return to the Settings menu.

## Backlight

The Backlight setting lets you adjust the intensity of the screen. To adjust the backlight, drag the slider left to right.

The Backlight setting also lets you set timers to automatically turn off the backlight after a specified period of inactivity. These timers apply when the 375 is running on or off external power. Turning off the backlight after periods of inactivity will save power. To enable a timer, tap a drop-down menu and select the appropriate time interval.

When you have selected the appropriate Backlight settings, tap **OK** to retain this setting for this session only, **SET DEFAULT** to retain this setting upon start up, or **CANCEL** to exit without changes.

## Clock

The Clock setting lets you set the date and time on the 375 Field Communicator. Configure the date by using the drop-down menu. To configure the time, highlight the appropriate time field and use the arrows to scroll through values until you find the correct time. Select **OK** to save the changes and to close the window, or **CANCEL** to exit without changes.

## Contrast

The Contrast setting lets you adjust the lightest and darkest areas on the screen.

To adjust the contrast, drag the slider to the left or right. The window automatically adjusts the contrast as you move the slider. When you find an appropriate contrast setting, tap **OK** to retain this setting for this session only, **SET DEFAULT** to retain this setting upon start up, or **CANCEL** to exit without changes.

---

## NOTE

Temperature can affect contrast.

---

## License

The License setting lets you view the enabled licenses on the System Card. The HART Application license is standard in every 375 Field Communicator. Other licenses available include the FOUNDATION fieldbus, Easy Upgrade, and the Graphics options. Unlicensed features cannot be accessed.

The License screen also displays the System Card Serial Number (SN) and the unit name of the 375 Field Communicator. A unit name can be assigned by using the Easy Upgrade Programming Utility. See the Programming Utility online Help for more details. Tap **OK** to return to the Settings menu.

## Memory

The Memory setting lets you view available free space in the System Card, Internal Flash, RAM, and Expansion Module (if installed).

## Power Status

The Power Status setting lets you specify power management options for the 375 Field Communicator. These settings apply only when the 375 Field Communicator is running without the power supply/charger connected. To specify values for the stand-by or auto-off timers, select the time intervals from the drop-down menus. After the specified periods of inactivity, the stand-by timer puts the 375 Field Communicator in stand-by, or the auto-off timer turns off the 375 Field Communicator. If set to short intervals, these timers will save power.

The Maximize Power Savings option conserves additional power by letting the 375 Field Communicator enter stand-by or shut down when communicating with a device. To enable Maximize Power Savings, tap the checkbox and a checkmark appears. If this option is disabled, the 375 Field Communicator will not enter stand-by or shut down when communicating with a device.

The Maximize Power Savings option applies only when the 375 Field Communicator is communicating with a device. If it is not communicating with a device, the 375 Field Communicator enters stand-by or shuts down when the timer expires, independent of the Maximize Power Savings option. This can occur when viewing certain menus, such as the Settings menu or an Application main menu.

When you determine the appropriate power management settings, tap **OK** to apply the settings for this session only, **SET DEFAULT** to retain the settings upon start up, or **CANCEL** to exit without changes.

## Retrain the Battery

The Retrain the Battery setting lets you discharge the battery so it can be recharged to its full capacity. Use this option if you notice a decrease in charge life. This feature is more effective with the NiMH Battery Pack than the Li-Ion Power Module due to the different battery technologies. Ensure the power supply/charger is not connected when this operation is performed.

During the operation, the backlight is set to its brightest setting to quickly discharge the battery. The backlight, stand-by, and auto-off timers are disabled.

If you tap **CANCEL**, the battery stops discharging and the backlight, stand-by, and auto-off timers are re-enabled. The backlight setting is also restored.

After the battery is discharged, make sure it is fully recharged before using it without the power supply/charger. You can use the 375 Field Communicator while the battery is recharging.

To retrain the battery:

1. Disconnect the power supply/charger, if it is connected to the 375 Field Communicator.
2. Double-tap **Retrain The Battery** from the Settings menu.
3. Wait until the 375 Field Communicator shuts down. It may take up to several hours to discharge the battery, depending on the charge remaining when the operation began.
4. Connect the power supply/charger to the 375 Field Communicator and fully charge the battery.

## Touch Screen Alignment

The Touch Screen Alignment setting lets you calibrate the touch screen with the display. Tap the cross hairs firmly and accurately at each location on the window. The target continues to move until the touch screen is aligned. Touch screen alignment is retained upon start up.

## Event Capture

The Event Capture setting lets you create an event capture file (.rec), which is a log of communication, input, and screen output that occurs between the 375 Field Communicator and a device (HART only). When working with Technical Support personnel, you may be asked to create an event capture file to help troubleshoot issues that cannot be isolated or resolved by normal means. The event capture file can then be transferred to your PC and sent to Technical Support personnel for review.

Tap the desired radio button to activate the event capture feature. The radio button is highlighted black when selected. To delete an event capture, tap the **DELETE EVENT FILE** button.

---

### NOTE

While event capture is enabled, device warning messages do not appear.

---

To create and send an event capture file to Technical Support personnel:

1. Enable event captures and tap **OK**.
2. Start the HART Application.
3. Enter a file name for the event capture file and tap **OK**. The file is saved to a default location.
4. Perform the requested operations to capture the data.
5. Use the Easy Upgrade Programming Utility to transfer the file from your 375 Field Communicator to your PC. See the Easy Upgrade Programming Utility online Help for details.
6. Send the event capture file to Technical Support personnel.

## Exit to 375 Main Menu

Double-tap **Exit to 375 Main Menu** if you want to return to the 375 Main Menu.

---

## **Communicating with a PC**

The 375 Field Communicator can communicate with PCs using infrared technology. IrDA is a PC interface supported for the transfer of device descriptions, software updates, configurations, event captures, Application licenses, and ScratchPad files.

IrDA communication can either be built into the PC, such as a laptop, or provided through an adapter such as a USB to IrDA adapter. Refer to your IrDA manual for installation and operating instructions.

Throughput for infrared communications with the 375 Field Communicator is approximately 4 kilobytes/second. The maximum recommended distance between the IrDA and PC is 18 inches.

### **Card Readers**

The 375 Field Communicator can also communicate with PCs using a supported USB Secure Digital card reader. Insert the 375 System Card into a card reader, and system software upgrades and device descriptions can be sent to the System Card using the Easy Upgrade Programming Utility. Your System Card must be licensed for the Easy Upgrade option to download system software and device descriptions to it.

A supported card reader may be required to download a large system software upgrade to your System Card. See [www.fieldcommunicator.com](http://www.fieldcommunicator.com) or the `readme.txt` file on the Resource CD for the supported card readers.

---

### **NOTE**

Using Windows Explorer and a card reader to transfer files between the System Card and a PC can corrupt the System Card. This operation should only be performed under the direction of Technical Support personnel.

---

The card reader provides faster upload and download speeds than an IrDA adapter; however, it cannot transfer licenses, event capture files, or user data files. See the Easy Upgrade Programming Utility online Help for details.

---

**NOTE**

The instructions in this manual are written for using the IrDA connection, not the card reader.

---

**Listen For PC**

In Listen For PC mode, the 375 Field Communicator is under the control of a PC application for transferring data and managing device configurations. The PC application could be one of the following:

- AMS Suite: Intelligent Device Manager (version 6.2 or higher), software for managing devices and valves in a process plant. Currently, AMS Device Manager supports HART configurations only.
  - 375 Easy Upgrade Programming Utility.
- 

**NOTE**

The On/Off key, and the stand-by and auto-off timers are disabled when the 375 Field Communicator is in Listen For PC mode.

---

The 375 Field Communicator must be in Listen For PC mode when communicating through IrDA.

To enter Listen For PC:

1. From the 375 Main Menu, select **Listen For PC**.
2. Align the 375 Field Communicator IrDA interface with the PC IrDA interface or an IrDA adapter.
3. Complete the necessary transfers using the Easy Upgrade Programming Utility or AMS Device Manager. See the Easy Upgrade Programming Utility online Help for more information.
4. Tap **EXIT** to close the Listen For PC screen.

If new system software was downloaded to the 375 Field Communicator System Card, an update occurs upon exit.



## **Transfer HART Configurations using AMS Device Manager**

A Handheld Communicator Interface kit for AMS Device Manager (version 6.2 or higher) lets you use the 375 Field Communicator with AMS Device Manager. See the AMS Device Manager Books Online Help for more information.

To transfer HART configurations:

1. Set up a network interface for the 375 Field Communicator using AMS Device Manager Network Configuration. See the Books Online help for details.
2. Align the 375 Field Communicator IrDA interface with the PC IrDA interface, and enter Listen For PC mode.
3. In AMS Device Manager, double-click the 375 Field Communicator icon. The Expansion Module and Internal Flash icons are displayed.
4. Open a configuration file from one of the storage icons and perform your tasks with AMS Device Manager.

## **Easy Upgrade Programming Utility**

The Easy Upgrade Programming Utility lets you upgrade a 375 Field Communicator with the latest device descriptions (DDs) and system software. All 375s can transfer event captures and user data (text) files using the Easy Upgrade Programming Utility. A System Card must be licensed for Easy Upgrade to download new system software or DDs.

You can also enable new functionality, such as the Graphics license, for any 375 at your site by using the Online Licensing feature. Available licenses include FOUNDATION fieldbus, Graphics, and Easy Upgrade.

If you cannot download new system software or DDs because your System Card is full, use the Memory Management feature to select which DDs can be downloaded to your System Card. Reducing the number of DDs on a System Card can save a significant amount of space.

See the Easy Upgrade Programming Utility online Help for details.

## Using ScratchPad

ScratchPad is a text editor that you can use to create, open, edit, and save simple text (.txt) documents. You can transfer text files between a PC and the 375 Field Communicator using the Easy Upgrade Programming Utility. ScratchPad supports very basic formatting.

From the 375 Main Menu, double-tap **ScratchPad** to run the ScratchPad. You can also launch the ScratchPad from within the HART or Fieldbus Application by tapping the ScratchPad (📄) icon in the upper right corner of the screen.

---

### NOTE

The On/Off key, and the stand-by and auto-off timers are disabled when ScratchPad is open.

---

After ScratchPad is launched, you can perform the following operations:

### Create a New Document

From the Main Page in the ScratchPad, tap **NEW**. An empty text window and SIP keypad appears. See Figure 2-6. You are now ready to enter text into your new document.

A new document can also be created within ScratchPad by tapping the New (📄) icon in the toolbar or by selecting **File | New** from the menu.

Figure 2-6. New document in ScratchPad



## Open an Existing Document

1. From the Main Page in the ScratchPad, select the desired file located under File Name.
2. Tap the **OPEN** button. A text window and the SIP keypad appears. You are now ready to edit your document.

You can also open a document by selecting **File | Open** from the menu bar or by tapping the Open () icon in the toolbar.

## Enter Text

Using the stylus, tap the desired letters from the SIP keyboard. Using the keypad, press the desired keypad button in quick repetitions to display the appropriate letter or number.

## Select Text

Drag the stylus over the desired text to highlight, or to select all of the text in the document tap **Edit | Select All**.

## Cut Text

1. Select the text to be cut.
2. Tap **Edit | Cut**.

You can also cut text by selecting text and tapping the Cut () icon in the toolbar.

## Copy Text

1. Select the text to be copied.
2. Tap **Edit | Copy**.

You can also copy text by selecting text and tapping the Copy () icon in the toolbar.

## Paste Text

1. Copy the text to be pasted.
2. Tap a location on the screen. This is where the text will be pasted.
3. Tap **Edit | Paste**.

You can also paste text by copying the text to be pasted and tapping the Paste () icon in the toolbar.

## Save a Document

1. In your document, tap **File | Save**.
2. Type the file name in the dialog box if your document is new.
3. Tap **OK**.

You can also save a document by tapping the Save () icon in the toolbar.

## Save a Copy

To save a copy of the current document under another name:

1. In your document, tap **File | Save As...**
2. Type the copy file name in the dialog box.
3. Tap **OK**.

## Delete a Document

There are three options for deleting a ScratchPad document:

### Option 1

1. From the Main Page in ScratchPad, select the file to be deleted.
2. Tap **DELETE**.
3. A warning appears telling you that the selected file will be permanently deleted. If you are sure you want to delete this file, tap **Yes**.

### Option 2

1. To delete from your document, tap **File | Delete**.
2. From the Delete File Page, tap the desired file to be deleted.
3. Tap **OK**.
4. A warning appears telling you that the selected file will be permanently deleted. If you are sure you want to delete this file, tap **Yes**.
5. Tap **EXIT** when you are finished deleting files.

### Option 3

Delete the .txt file using the Easy Upgrade Programming Utility. See the Easy Upgrade Programming Utility online Help for more information.

## Exit ScratchPad

1. In your document, tap **File | Exit**.
2. Tap the **EXIT** button from the Main Page.

## MANAGING STORAGE

### Types of Storage

The 375 Field Communicator memory consists of four components:

1. Internal Flash—32MB non-volatile RAM. The Internal Flash memory stores the operating system and system software. It also stores the following:
  - Up to 25 HART configurations
  - HART event captures
  - FOUNDATION fieldbus statistics
  - User generated text files

The optional Configuration Expansion Module (spare part number 00375-0043-0001) lets you store more than 25 configurations; see below for more information.

2. System Card—an internal Secure Digital Card with non-volatile Flash memory. A copy of installable 375 Field Communicator system software exists on every System Card. The System Card also contains all HART and FOUNDATION fieldbus device descriptions.
3. RAM—32MB used only for program execution.
4. Expansion Module—an optional removable memory card that snaps into the Expansion Port on the side of the 375 Field Communicator. The Configuration Expansion Module can store in excess of 500 HART configurations.

## **Free Memory on a System Card**

When you add new device descriptions and system software to your 375 Field Communicator, more space on your System Card is used. Over time, your System Card will become full and there will not be enough memory to add new files.

You can use the System Card Memory Management feature in the Easy Upgrade Programming Utility to free space on your System Card. This feature lets you select which device descriptions can be downloaded. Reducing the number of DDs on a System Card can save a significant amount of space. For example, if your site uses only HART devices, use Memory Management to ensure only device descriptions for these devices are downloaded to your System Card. See the Easy Upgrade Programming Utility help for details.

## **MAINTENANCE**

Any maintenance, repair, or replacement of components not listed below must be performed by specially trained personnel at authorized service centers. You can perform common maintenance procedures on the 375 Field Communicator, as described below:

- Cleaning the exterior. Use only a dry, lint-free towel or dampen the towel with a mild soap and water solution.
- Charging, removing, and replacing the battery.
- Removing and replacing the System Card.
- Removing and replacing the Expansion Module or Expansion Port Plug.
- Removing and replacing the stand assembly.
- Ensuring that all exterior screws are sufficiently tightened.
- Ensuring that the Communication Terminal recess is free of dirt and debris (does not require disassembly).

## **Running a Self Test**

There is no need, nor is it possible, to perform a manual self test with the 375 Field Communicator. Testing features are done automatically. A warning message appears if a fault condition is found during these tests.

## Calibrating

It is not necessary or possible to calibrate the 375 Field Communicator. The 375 Field Communicator is a communication interface that communicates digitally with HART and FOUNDATION fieldbus devices.

Voltage measurements made by the 375 Field Communicator are for use in detection of power or noise on a network and are for reference purposes only. Your 375 Field Communicator is not applicable to NIST standards and is not subject to calibration.

## WASTE DISPOSAL

Products with the following label comply with the Waste Electrical and Electronic Equipment (WEEE) directive, 2002/96/EC, which applies to European Union (EU) member states only.



The label indicates this product should be recycled and not treated as household waste. Customers in EU member states should contact their local Emerson sales

representative for information on discarding any part of the 375 Field Communicator.

For customers in all other world areas, if it is necessary to discard any part of the 375 Field Communicator, adhere to the waste-disposal regulations applicable in your locality.

## HAZARDOUS SUBSTANCES

Products with the following label are lead-free and comply with the Restriction of the Use of Certain Hazardous Substances in Electrical and Electronic Equipment (RoHS) directive, 2002/95/EC, which applies to EU member states only.



The purpose of the directive is to limit the use of lead, cadmium, mercury, hexavalent chromium, polybrominated biphenyl (PBB), and polybrominated diphenyl ether (PBDE) flame retardants in electronic equipment.





## SECTION 3 HART FUNCTIONALITY

### OVERVIEW

This section provides instruction on basic HART functionality in the 375 Field Communicator. It is based on the operation of the HART Application version 4.0.

### SAFETY MESSAGES

Procedures and instructions in this section may require special precautions to ensure the safety of the personnel performing the operation. Information that raises potential safety issues is indicated by a warning symbol () . Refer to the following safety messages before performing an operation preceded by this symbol. Other warning messages can be found in the Troubleshooting section of this manual.

#### WARNING



If you choose to ignore all field device status messages, every message from nuisance to critical will be ignored.

#### WARNING

Voltage measurements are for reference purposes only. Do not make critical process control decisions based upon these measurements.

## BASIC FEATURES AND FUNCTIONS

### Interpreting the HART icon

A beating hollow heart icon (  ) is displayed when the 375 Field Communicator is communicating with a live HART device. A solid beating heart is displayed when the 375 Field Communicator is communicating to a HART loop with a device in burst mode. A hollow or solid heart surrounded by rays (  ) indicates the 375 Field Communicator is in shout/deaf mode, which helps the 375 communicate with a device when it is on a noisy loop. The HART logo is displayed when communication is not occurring. This is common when only static parameters are listed.

## USING A FAST KEY SEQUENCE

A Fast Key sequence is a sequence of numerical button presses, corresponding to the menu options that lead you to a given task. The Fast Key sequences are identical to the sequences used on the 275 HART Communicator. See your field device documentation for fast key sequence options.

## STARTING THE HART APPLICATION

To start the HART Application:

1. Turn on the 375 Field Communicator.
2. Double-tap **HART Application** on the 375 Main Menu. If a live HART device is connected to the 375 Field Communicator, the HART Application Online menu displays automatically. If a device is not connected, the HART Application main menu displays after a few seconds.

To navigate back to the 375 Main Menu, press the back arrow key.

From the HART Application main menu, you can choose Offline, Online, Utility, or HART Diagnostics functions. The rest of this section will guide you through the HART Application menus and functions.

## **WORKING OFFLINE**

The Offline menu lets you create, view, and change offline configurations stored in the 375 Field Communicator.

There are two types of HART configurations: device configurations and user configurations. A device configuration is created from a connected, online HART device. A user configuration is created offline or transferred to a 375 Field Communicator from another program. Editing a device configuration within the 375 Field Communicator changes it to a user configuration.

The concept of partial or standard configurations does not apply to the 375 Field Communicator. All configurations are full configurations.

## **Creating New Configurations**

Creating a new configuration lets you create a user configuration for a specific device type and revision.

To create a new HART configuration while working offline:

1. From the HART Application main menu, double-tap **Offline**.
2. Double-tap **New Configuration**. The manufacturer names of the installed device descriptions are listed.
3. Double-tap the desired manufacturer to expand the list. The models available for the manufacturer are listed.
4. Double-tap the desired device model to expand the list. The device revisions available for the selected device model are listed.
5. Double-tap the desired device revision.
6. If a warning appears, thoroughly read the warning, tap **CONT** to accept the warning and proceed, or tap **EXIT**.
7. Mark the configurable variables you want sent to the HART device. Double-tap **Mark all | OK** to have all variables marked. Double-tap **Unmark all | OK** to clear the marks from all variables. A "+" symbol indicates a mark to send. A "\*" symbol indicates a parameter has been edited.

To mark and edit variables individually:

- a. Double-tap **Edit individually** to configure specific variables before sending them to a device.
- b. Scroll through the list of variables and select the variable you want to mark or edit.

To change the value for the selected variable, tap **EDIT**, change the value, and tap **ENTER**.

To mark the selected variable, tap **MARK**.

- c. Repeat these steps for other variables as necessary and tap **EXIT** when you are finished.
8. To save a new configuration, double-tap **Save as...** (The SAVE button automatically brings you to the Save as... menu.)
- a. To change the location where the configuration is saved, double-tap **Location**, select an option, and tap **ENTER**.
  - b. To specify a name for the configuration, double-tap **Name**, enter the name, and tap **ENTER**.
  - c. Tap **SAVE**.

## Opening Saved Configurations

Once opened, a saved configuration lets you edit, copy, send, delete, or rename it. You can also compare it to other saved configurations.

To open a saved configuration:

1. From the HART Application main menu, double-tap **Offline**.
2. Double-tap **Saved Configuration**.
3. Double-tap the storage location where you saved the configuration—Internal Flash Contents or Configuration EM (Expansion Module) Contents.
4. Double-tap the desired configuration to open the menu selection.

The FILTR button opens a menu that provides both sort and tag filter options. These options let you customize your view of saved configurations.

- The Sort option lets you group and display configurations according to your choice of name, tag, or descriptor.
- The Filter option lets you customize your group according to what you entered with Sort by picking characters from the device name, tag, or descriptor.

When setting up a filter, you can use two special characters: the period (.) and the asterisk (\*). The period replaces a single character of any value. The asterisk represents a string of alphanumeric characters of any value.

For example, if you want to list all configurations that have a tag or name of P - 001 to P - 300, enter "P - \*" in the filter. If you want to list configurations that have a tag or name that begins P - 0 and ends with a 7, set the filter to "P - 0.7".

The XPAND button lets you view the device name, tag, manufacturer, device type, device revision, descriptor, and the configuration type. Tap **CMPRS** to return to the previous compressed screen.

## Edit a Saved Configuration

The Edit option lets you edit a saved configuration while working offline.

To edit a saved configuration:

1. Open a saved configuration.
2. From the Saved Configuration menu, double-tap **Edit**.
3. If a warning appears, thoroughly read the warning, tap **CONT** to accept the warning and proceed, or tap **EXIT** to end this operation.
4. Mark the configurable variables you want saved in the configuration. Double-tap **Mark all | OK** to have all variables marked. Double-tap **Unmark all | OK** to clear the marks from all variables. To mark and edit variables individually:
  - a. Double-tap **Edit individually** to configure specific variables before sending them to a device.
  - b. Scroll through the list of variables and select the variable you want to mark or edit.

To change the value for the selected variable, tap **EDIT**, change the value, and tap **ENTER**.

To mark the selected variable, tap **MARK**. A "+" symbol indicates a mark to send. A "\*" symbol indicates a parameter has been edited.
  - c. Repeat these steps for other variables as necessary.
  - d. Tap **Exit**.
5. Tap **SAVE**.

## Copy a Saved Configuration

The Copy to... option lets you copy a saved configuration to a new storage location.

To copy a saved configuration:

1. Open a saved configuration.
2. From the Saved Configuration menu, double-tap **Copy to...**
3. Double-tap Location and choose the storage location to which you want to save the configuration—Internal Flash or Configuration Expansion Module (EM) and tap **ENTER**.
4. Double-tap **Name**, enter the name for the copy of the configuration, and tap **ENTER**.
5. Tap **SAVE** to copy the configuration to a new location.

## Send a Saved Configuration to a Connected Device

The Send option lets you send the open configuration to a connected device. From the Saved Configuration menu, double-tap **Send**. The 375 Field Communicator sends the configuration to a connected device that is compatible with the configuration.

## Delete a Saved Configuration

The Delete option lets you remove a configuration from the 375 Field Communicator.

To delete a configuration from the 375 Field Communicator:

1. Open a saved configuration.
2. From the Saved Configuration menu, double-tap **Delete**.
3. Tap **Yes** to confirm the deletion.

## Rename a Saved Configuration

The Rename option lets you change the name of a saved configuration.

To rename a saved HART configuration:

1. Open a saved configuration.
2. From the Saved Configuration menu, double-tap **Rename**.
3. Enter the new file name and tap **ENTER**.
4. Tap **SAVE**.

## Compare Two Saved Configurations

Any two configurations can be compared. However, the conditions below must be met to compare two configurations of the same field device.

- Device type (including manufacturer), device revision, and DD revision must match exactly. A dialog box appears if the configuration is different, but you will not be told the differences.
- Configurations can only be compared against other configurations containing the same set of variables. The 375 Field Communicator notifies you if this condition is not met.
- The format of data storage must match exactly. The 375 Field Communicator notifies you if this condition is not met.

To compare two saved configurations:

1. Open a saved configuration.
2. From the Saved Configuration menu, double-tap **Compare**.
3. Choose the storage location that contains the other configuration file—Internal Flash or Configuration EM (Expansion Module) and tap **ENTER**.
4. Double-tap **Name** to select the configuration file.
5. Double-tap the desired file to compare.
6. Tap **COMP** to compare the configurations.
7. Tap **OK**.

**WORKING  
ONLINE**

The 375 Field Communicator can communicate with a transmitter from the control room, the instrument site, or any wiring termination point in the loop.

**Connecting to  
a HART Loop**

Connect the 375 Field Communicator with the appropriate connectors in parallel with the instrument or load resistor. The HART connections are not polarity sensitive.

A minimum of 250 ohms resistance must be present in the HART loop for the 375 Field Communicator to function properly.

For information about intrinsically safe connections, see Appendix B.

---

**NOTE**

Dynamic variables shown while online represent the digital data being sent from the device.

---

Three terminals for the lead set are on the top of the 375 Field Communicator. The lead set and terminals let you connect the 375 Field Communicator to a device. Each red terminal is a positive connection for its protocol. The black terminal is a common terminal shared by both protocols. An access door ensures only one pair of terminals is exposed at any one time; see Figure 3-1. Several markings indicate which pair of terminals is for which protocol.

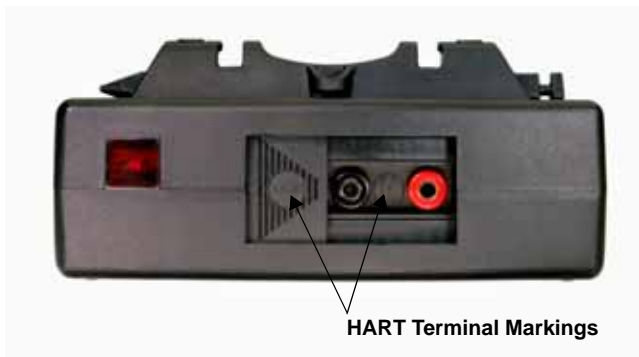

Figure 3-1. HART Terminal Access Door

**NOTE**

The lead set must be used to communicate with a wired or wireless device.

Figure 3-2 illustrates how to connect the 375 Field Communicator to a HART loop.

Figure 3-2. Connecting to a HART Loop

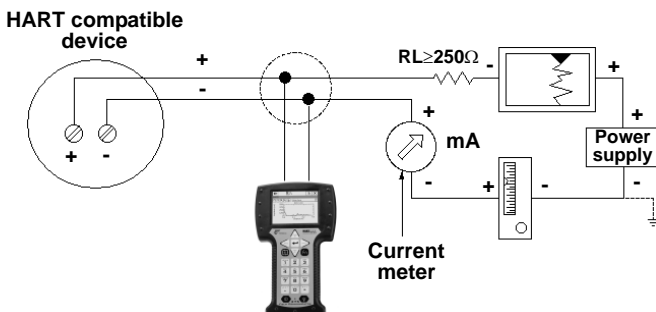

Figure 3-3 illustrates how to connect the 375 Field Communicator directly to the terminals of a HART device.

Figure 3-3. Connecting Directly to a HART Device

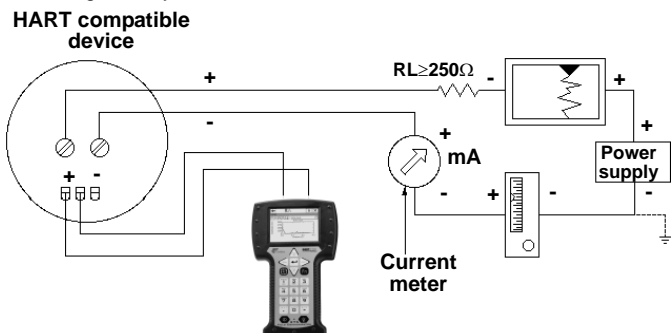
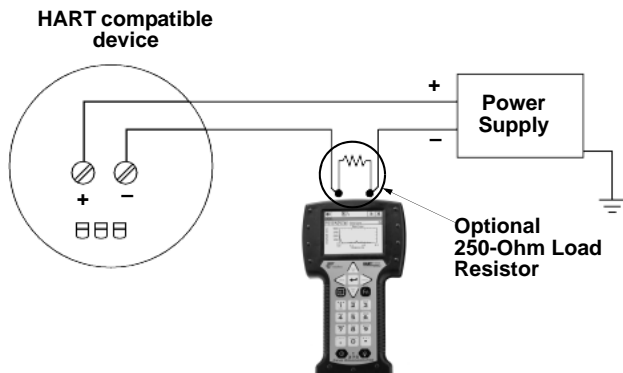

Figure 3-4 illustrates how to connect the optional 250 ohm resistor. Attaching a resistor is necessary if less than 250 ohms resistance is present in the HART loop.

Figure 3-4. Connecting with a 250 Ohm Resistor



To temporarily install the optional 250 ohm load resistor:

1. Insert the load resistor into the lead set jacks.
2. Open the loop to allow connection of the resistor in series in the loop.
3. Close the loop using the lead set connectors.

## Displaying the Online Menu

The Online menu is the first menu to appear when connected to a HART device. To view process information for a connected device, select an item from the Online menu. A typical online menu is shown in Figure 3-5.

This menu displays critical, up-to-date process information that is continuously updated, including device setup, primary variable (PV), analog output (AO), PV lower range value (LRV), and PV upper range value (URV). The configuration parameters for devices vary from device to device and are defined in the device description. See your field device user's manual for more information.

Figure 3-5. Online Menu Example

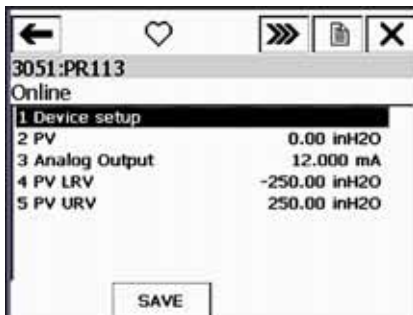

Because the Online menu displays important information, some menus provide instant access to this window. When access is available, the HOME button is displayed to return you to the HART Online menu.

Once you have made changes to the parameters, you can send them to the device from this window. An asterisk appears next to the parameter name of any un-sent item.

## Saving an Online Device Configuration

When a configuration is saved from a connected device, it is saved as a device configuration.

To save the configuration in the connected device:

1. Connect the 375 Field Communicator to a HART loop or directly to the device and turn on the 375 Field Communicator.
2. Double-tap **HART Application** from the 375 Main Menu. The HART Online menu appears.
3. Tap **Save**.
  - a. To set the location where the configuration will be saved, double-tap **Location**, select Internal Flash or Configuration EM (Expansion Module), and tap **ENTER**.
  - b. To enter a name for the configuration, double-tap **Name**, type the name, and tap **ENTER**.
4. Tap **Save**. If the configuration already exists, a message is displayed. Tap **YES** to overwrite the older version with the new version, or tap **NO** to return to the Save as screen.

## Displaying the Device Setup Submenu

The Device Setup menu accesses every configurable parameter of the connected device. Double-tap **Device setup** to view the process variables, diagnostics and service, basic setup, detailed setup, and review menus.

### Process Variables (PV)

The PV menu lists all process variables and their values. Process variables are continuously updated when this screen is displayed.

### Diagnostics and Service

The Diagnostics and Service menu lists device and loop tests as well as calibration options. The diagnostics and service operations that are available vary widely from device to device and are defined in the device description.

The *Test device* menu lists the status as well as self and master test of the device. Test device initiates a diagnostic routine at the device and can report an electronics failure, as well as other failures that can affect performance.

*Loop test* is used to set the output of the device at a specified analog value, and may be used to test the integrity of the loop and the operation of indicators, recorders, or similar devices in the loop.

*Calibration* is used to perform such operations as performing a sensor trim, D/A trim, and scaled D/A trim.

## **Basic setup**

The Basic setup menu provides quick access to a number of configurable parameters including tag, unit, range values, and damping.

The options available in the Basic setup menu are the most fundamental tasks that can be performed with a device. These tasks are a subset of the options available under the Detailed setup menu.

The *Tag* alphanumeric identifies a specific device. Changing the unit option affects the engineering units that are displayed. Changing range values changes the analog output scaling. Changing damping affects the response time of the transmitter and is often used to smooth the output when there are rapid input variations.

## **Detailed setup**

The Detailed setup menu provides access to every editable device parameter and all device functions. The Detailed setup menu varies from one HART device to another. Functions in this menu can include characterization, configuration, and sensor and output trims.

## **Review**

The Review menu lists all of the static parameters read from the connected device, including information about the device and sensor setup and limitations. It also includes information about the connected device such as tag, materials of construction, and device software revision.

## Displaying Graphics

The HART Application offers graphical views of device data by using the enhanced Electronic Device Description Language (EDDL) technology. Device data can be presented as images, charts, and graphs. These options are displayed as items in the Online menu and its submenus. The placement of the Graphics options in the menus varies from device to device because it is determined by the device manufacturer.

To view the graphical representations, you need a device with enhanced EDDL, a 375 Field Communicator with a Graphics license, and 375 system software version 2.0 or higher. Only devices with enhanced EDDL offer graphical representations of data. If the 375 Field Communicator does not have a Graphics license, enhanced DDs can still be used. However, the graphical representations are not displayed.

The Graphics license can be purchased through your 375 sales representative. The Graphics license can then be enabled in a 375 by using the Online Licensing feature in the Easy Upgrade Programming Utility. See Appendix C for more information about the Graphics functionality.

## USING HOT KEYS

### Setting up Hot Key Options

The Hot Key menu is a user-definable menu that can store shortcuts for up to 20 of your most frequently performed tasks. For example, if you change device tags and damping often, you can add options for these functions to the Hot Key menu. When you are online, the Hot Key automatically appears in the toolbar. Hot Keys created from generic DDs will not be saved.

To add a custom option to the Hot Key menu:

1. Select the option you want to add to the Hot Key menu from the Online menu or any of the submenus.
2. Tap and hold the Hot Key (). The Hot Key Configuration window shows the new option you are adding.
3. Tap **ADD**.
4. Tap **ALL** to add the Hot Key option for all devices supported by the 375 Field Communicator, or tap **ONE** to add the Hot Key option for only the device type to which you are currently connected.
5. If the message “Mark as read only variable on Hot Key menu” displays, choose one of the following:
  - **YES**: The variable for this option is read-only, meaning you can view but not change its value.
  - **NO**: You can view and change the value for this variable.
6. Respond to the message “Display value of variable on Hot Key menu?” by choosing one of the following:
  - **YES**: The value of this variable will appear on the Hot Key menu.
  - **NO**: The Hot Key menu will show the name of the variable but not its value.
7. Tap the **EXIT** button on the Hot Key Configuration window to return to the original menu. The new option is added to the Hot Key menu.

## Executing a Hot Key Option

To use a Hot Key option, you must first properly connect the 375 Field Communicator to a device. You can access the Hot Key menu from any online screen.

To use a Hot Key option:

1. Connect the 375 Field Communicator to a HART loop or device.
2. Tap the Hot Key ()
3. Double-tap the desired option from the Hot Key menu.

## Removing a Hot Key Option

To remove individual Hot Key options:

1. Tap and hold the Hot Key () . The Hot Key Configuration window appears.
2. Double-tap the menu option you want to remove.

---

### NOTE

Range Values is a predefined option and cannot be removed. It provides quick access for viewing or changing the range for a device.

---

3. Tap the **DEL** button.
4. When you are done, tap **EXIT** to close the Hot Key Configuration window.

## Removing all Hot Key Options

To remove all Hot Key options currently defined:

1. From the HART Application main menu, double-tap **Utility**.
2. Double-tap **Configure HART Application**.
3. Double-tap **Storage Cleanup**.
4. Double-tap **Hotkey Menu**.
5. Tap **YES** if you are sure you want to delete all the items from the Hot Key menu. Tap **NO** to return to the Storage Cleanup menu.



## CONFIGURING THE HART APPLICATION

### Changing the HART Polling Option

Use the HART polling option to configure your 375 Field Communicator to automatically search for all or specific connected devices. Most HART device installations contain one device per loop and the device address is zero.

To have more than one device per loop, wire the devices in parallel and place into “Multidrop” mode. This mode is enabled by changing the address from zero to any address between 1-63. After the mode is enabled, the analog output of each device is fixed and no longer represents any variable.

---

#### NOTE

Communication errors, such as a device appearing at multiple addresses, can occur when you poll addresses greater than 15 on a loop with both HART revision 5 or earlier and HART revision 6 or 7 devices.

---

To change the polling option:

1. From the HART Application main menu, double-tap **Utility**.
2. Double-tap **Configure HART Application**.
3. Double-tap **Polling Options**. Select one of the following polling options:
  - **Poll by Address** - Lets you poll for devices at the addresses listed in the Polling Addresses menu option. The Polling Addresses menu appears on the Configure HART Application screen only when Poll by Address is selected. Select one of the following options from the Polling Addresses menu:

Polling Address	Use
0	Poll loops that are not multi-dropped.
0-15	Poll HART revision 5 or earlier devices on multi-dropped loops.
0-63	Poll HART revision 6 or 7 devices on multi-dropped loops.
63	Poll the default address for HART revision 7 WirelessHART adapters.
Custom Range	Poll a unique or non-consecutive group of addresses (example: "0, 5-7, 12"). Use a hyphen to specify consecutive addresses and a comma to separate numbers or groups of numbers.

- **Poll Using Tag** - Lets you enter and poll by the tag of the device. You are prompted to enter a tag name when the HART Application starts.
- **Poll Using Long Tag** - Lets you enter and poll by the long tag of the device. You are prompted to enter a tag name when the HART Application starts. (Only supported in HART revision 6 or higher devices.) Double-tap when the tag is truncated to display the full tag.
- **Poll Using Unique ID** - Lets you poll using the device's unique ID. For HART revision 7 devices, the unique ID is the expanded device type, a hyphen, and device ID. For HART revision 6 and earlier devices, the unique ID is the manufacturer ID, device type, a hyphen, and device ID.

#### 4. Tap **Enter**.

Refer to your device manual for information about changing a device polling address.

## Changing Ignored Status Messages

The 375 Field Communicator displays status messages from the connected HART device. The Ignore Status option lets you specify the number of field device status messages that are ignored, extending the time between displayed messages. The default is 50 messages. If you choose to ignore all field device status messages, every message from nuisance to critical will be ignored.

To change the number of ignored status messages:

1. From the HART Application main menu, double-tap **Utility**.
2. Double-tap **Configure HART Application**.
3. Double-tap **Ignore Status**.
4. Enter the number of status messages you want ignored before the next message is displayed. You can specify a number from 50 to 500.
- ⚠ 5. Tap **ENTER**. All field device status messages are ignored until the quantity specified has been reached.

## Changing the Menu Title

The HART 6 Tag menu lets you choose if the HART short or long tag is displayed in the menu title for HART revision 6 devices. The short tag can have up to 8 characters, and the long tag can have up to 32 characters. These tags can be edited at any time. If the long tag does not fit on the screen, an ellipsis is shown at the end of the tag. The location of these parameters in the Online menu varies because it is determined by the device manufacturer.

To select a HART tag for the menu title:

1. From the HART Application main menu, double-tap **Utility**.
2. Double-tap **Configure HART Application**.
3. Double-tap **HART 6 Tag**.
4. Select Show Long Tag to display the HART long tag, or select Show Short Tag to display the HART short tag.
5. Tap **ENTER**. The 375 Field Communicator continues to use the option you selected until you change the setting.

## Storage Cleanup

The Storage Cleanup menu lets you delete the following items:

- **Internal Flash** - By selecting **YES**, you will remove all configurations saved in the Internal Flash.
- **Configuration Expansion Module** - By selecting **YES**, you will remove all configurations saved in the Configuration Expansion Module.
- **Hotkey Menu** - By selecting **YES**, you will delete all items from the Hotkey menu.

## Viewing Available Device Descriptions

The Available Device Descriptions menu lets you view all the device descriptions in the 375 Field Communicator. HART device descriptions enable the 375 Field Communicator to recognize and configure specific HART devices.

To view the currently installed HART device descriptions:

1. On the HART Application main menu, double-tap **Utility**.
2. Double-tap **Available Device Descriptions**. The manufacturer names of the installed device descriptions are listed.
3. Double-tap the desired device manufacturer to expand the list. The models available for the manufacturer are listed.
4. Double-tap the desired device model. The device revisions available for the selected model are listed. One of the following icons appears next to each device description to indicate its status:

 - A tested device description can be used with the system software version in the 375 Field Communicator.

 - An untested device description has not been formally tested for use with the system software version in the 375 Field Communicator. The device description can be used, but you may experience unexpected results.

 - An incompatible device description cannot be used with the system software version in the 375 Field Communicator.

## Simulating an Online Connection to a HART Device

The 375 Field Communicator has a simulation mode that lets you simulate an online connection to a HART device without actually connecting to a device. Simulation mode is a training tool that helps you become familiar with devices before configuring them in a critical environment. A simulated configuration cannot be saved. Not all device descriptions have been optimized to run under simulation.

To simulate a connection to a HART device:

1. From the HART Application main menu, double-tap **Utility**.
2. Double-tap **Simulation**. The manufacturers with device descriptions installed in the 375 Field Communicator are listed.
3. Double-tap the desired manufacturer to expand the list. The models available for the manufacturer are listed.
4. Double-tap the desired model to expand the list. The device revisions available for the selected model are listed.
5. Double-tap the desired device revision. Refer to the device manual to determine the device revision.
6. If a warning appears, thoroughly read the warning, tap **CONT** to accept the warning and proceed, or tap **EXIT** to return to the Utility menu. (This warning will not appear if your device is tested.) The Online menu for the simulated device is displayed. You can now use the 375 Field Communicator as if it were connected to the selected device and perform any online task.

## RUNNING HART DIAGNOSTICS

### DC Voltage Measurement (HART Terminals)

The HART DC voltage measurement takes a voltage reading at the HART connector and displays it on the screen.

To check the device voltage:

1. From the HART Application main menu, double-tap **HART Diagnostics**.

-  2. Double-tap **DC Voltage Measurement**. The DC voltage measurement is displayed. Tap **OK** when done viewing the measurement. To refresh the screen, double-tap **DC Voltage Measurement** from the HART Diagnostics menu. Voltage measurements are for reference purposes only.

### DISCONNECTING FROM A HART DEVICE

Prior to disconnecting the 375 Field Communicator from a HART device, be sure to check the following items:

- Determine if you want to save a configuration.
- Verify methods are complete.
- Resolve any un-sent data to the device.

## SECTION 4    FIELDBUS FUNCTIONALITY

### OVERVIEW

This section provides instruction on basic fieldbus functionality in the 375 Field Communicator. It is based on the operation of the FOUNDATION Fieldbus Application version 5.0.

### SAFETY MESSAGES

Procedures and instructions in this section may require special precautions to ensure the safety of the personnel performing the operation. Information that raises potential safety issues is indicated by a warning symbol () . Refer to the following safety messages before performing an operation preceded by this symbol. Other warning messages can be found in the Troubleshooting section of this manual.

#### **WARNING**

If a segment is connected to a host system, the changes made with the 375 Field Communicator may not be recorded in the host system's permanent database. Verify the changes in the database. Otherwise, this could cause unpredictable results and, depending upon your application, process disruption leading to property damage, serious injury, or death. Ensure all safety precautions and work procedures have been followed.

#### **WARNING**

Changing device parameters could adversely affect the control of your process. Put the control loop in Manual/Out of Service before applying changes. Verify the output before returning the control loop to Auto. Failure to do so could result in property damage, serious injury, or death. Ensure all safety precautions and work procedures have been followed.

 **WARNING**

The 375 Field Communicator draws approximately 17 mA from the fieldbus segment. Be sure the power supply or barrier on the fieldbus segment has the capacity to provide this additional current. If a heavily loaded fieldbus segment is drawing near the capacity of the segment's power supply, connecting the 375 Field Communicator may result in loss of communication.

## **BASIC FEATURES AND FUNCTIONS**

### **Link Active Scheduler (LAS)**

All segments have only one Link Active Scheduler (LAS). The LAS operates as the bus arbiter for the segment. The 375 Field Communicator is set up to always be the last node to become the LAS on a segment.

The devices that are capable of becoming the LAS are called link master devices. All other devices are referred to as basic devices. When a segment first starts up, or upon failure of the existing LAS, the link master devices on the segment bid to become the LAS. The link master that wins the bid (the one with the lowest address) begins operating as the LAS immediately upon completion of the bidding process. Link masters that do not become the LAS can act as LAS backups by monitoring the segment for failure of the LAS and then bidding to become the LAS when a LAS failure is detected.

Although the 375 Field Communicator is capable of becoming the LAS, it does not maintain the communication schedule and should not be thought of as a backup LAS.

Only one device can communicate at a time. Permission to communicate on the bus is controlled by a centralized token passed between devices by the LAS. Only the device with the token can communicate. The LAS maintains a list of all devices that need access to the bus. This list is called the Live Device List; see "Displaying the Live Device List" on page 4-9.



**LAS Hierarchy** When a 375 Field Communicator is connected to a live fieldbus segment, it joins the fieldbus segment but not as the LAS. This means the 375 Field Communicator can view and edit device parameters, but the control of the segment is still handled by the node that is designated the LAS for the segment. You can also read and write if there is another LAS. Prior to connecting to a host system, review the 375 Field Communicator Host System Interoperability on [www.fieldcommunicator.com](http://www.fieldcommunicator.com).

**Device Interoperability** The 375 Field Communicator is designed to operate with a wide range of FOUNDATION fieldbus devices independent of device manufacturer. Device interoperability is achieved through the use of Device Description Language (DDL) technology supported by the Fieldbus Foundation.

Basic testing is performed on all device descriptions. In addition, each device manufacturer is asked to certify that they have thoroughly tested their devices with the 375 Field Communicator. If certification is not received, a warning message will display when you attempt to access an untested device.

**ST\_REV** ST\_REV is a block parameter that increments each time a block configuration has changed. While a list of parameters is displayed, the 375 Field Communicator continuously reads the ST\_REV of that particular block. If it sees the ST\_REV counter has incremented, it knows that there has been a change to the block, and it automatically refreshes (rereads) all of the block parameters. Thus, there would only be a very short period of time before a change made by another host would appear on the 375 Field Communicator display.

## STARTING THE FIELDBUS APPLICATION

A general warning message may appear upon starting the Fieldbus Application when an LAS is detected on the segment. Select YES to go to the Live Device List, NO to return to the 375 Main Menu, or HELP to get more information on the warning.

To start the Fieldbus Application:

1. Turn on the 375 Field Communicator. The 375 Main Menu is displayed.
2. Double-tap **FOUNDATION Fieldbus Application** from the 375 Main Menu. If a live fieldbus device is connected to the 375 Field Communicator, the Fieldbus Application main menu will briefly display followed by the Live Device List. Figure 4-1 shows the Fieldbus Application main menu.

If insufficient voltage is detected, a warning message appears. Press OK to go to the Fieldbus Application main menu.

Figure 4-1. Fieldbus Application main menu screen

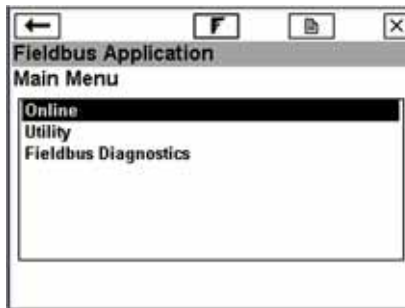

A connection warning message may appear if no communication is detected. This means that a LAS is not recognized by the 375 Field Communicator. This typically occurs when connecting to a single device.

To go back to the 375 Main Menu, press the back arrow button. From the Fieldbus Application main menu, you can choose Online, Utility, or Fieldbus Diagnostic functions. The rest of this section guides you through the Fieldbus Application menus and functions.

**WORKING  
ONLINE**

The online menu display data for the device to which you are connected. The online menu display critical, up-to-date process information, including the segment Live Device List, Block Lists, device menus, and parameter functionality.

---

**NOTE**

It is normal for processes to take longer the greater the amount of scheduled communication. This is influenced by the number of devices and the control methods in place.

---

**Connecting to  
a Fieldbus  
Segment**

Connect the 375 Field Communicator with the appropriate connectors in parallel with the device. Due to measurement circuitry, the 375 Field Communicator fieldbus connections are polarity sensitive. An error message displays if the device is connected incorrectly.

For information about intrinsically safe connections, see Appendix B.

---

**NOTE**

Dynamic variables shown while online represent the digital data being sent from the device.

---

Digital communication is susceptible to electrical noise; follow proper wiring instructions.

Three terminals for the lead set are on the top of the 375 Field Communicator. The lead set and terminals let you connect the 375 Field Communicator to a device. Each red terminal is a positive connection for its protocol. The black terminal is a common terminal shared by both protocols. An access door ensures only one pair of terminals is exposed at any one time; see Figure 4-2. Several markings indicate which pair of terminals is for which protocol.

Figure 4-2. Fieldbus terminal access door



**Fieldbus Terminal Marking:**

## Bench Hook-Up

Figure 4-3 illustrates one method of connecting the 375 Field Communicator on a bench.

For segments that are limited in size, the power conditioner and terminators can be contained in a single wiring block.

Figure 4-3. Bench wiring diagram example

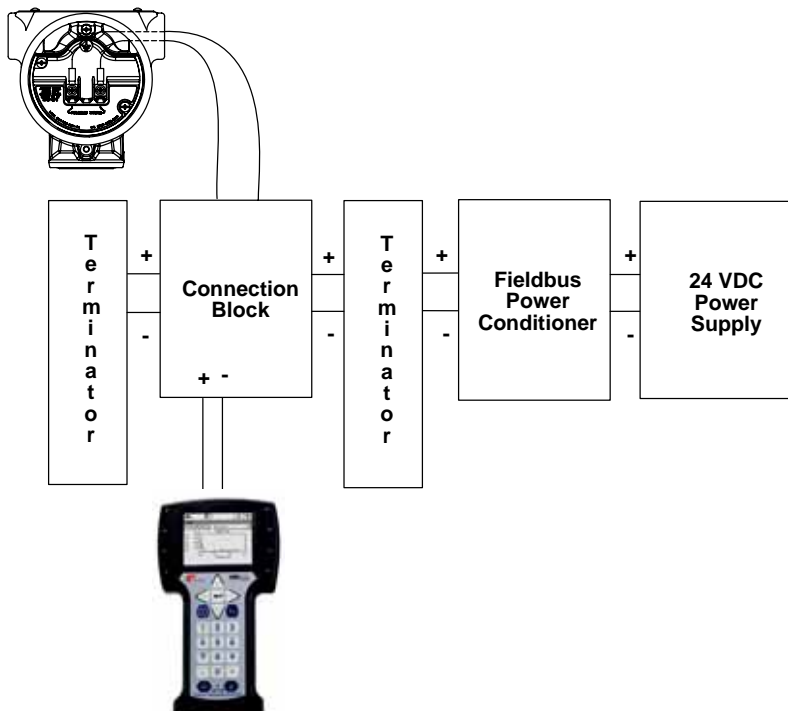

## Field Hook-Up

Figure 4-4 illustrates one method of connecting the 375 Field Communicator to a fieldbus segment. The 375 Field Communicator can be connected at any convenient place along the bus (segment). In the field, this is typically done at the device or at the fieldbus junction box.

Figure 4-4. Field wiring diagram example

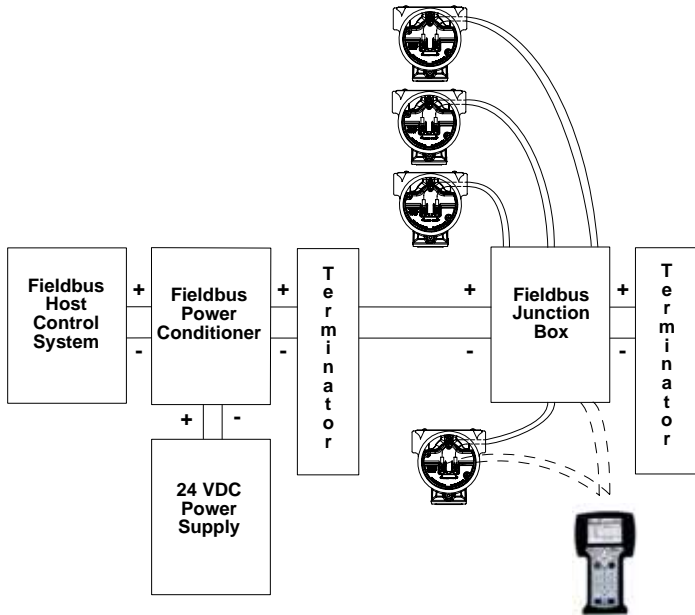

### NOTE

The 375 Field Communicator draws approximately 17 mA from the fieldbus segment. Be sure that the power supply or barrier on the fieldbus segment has the capacity to provide this additional current. If a heavily loaded fieldbus segment is drawing near the capacity of the segment's power supply, connecting the 375 may result in loss of communication.

## Displaying the Live Device List

To display the active devices on a Fieldbus segment (Live Device List):

1. Connect the 375 Field Communicator to a Fieldbus segment.
2. Turn on the 375 Field Communicator.
3. Double-tap **FOUNDATION Fieldbus Application** from the 375 Main Menu.
4. On the Fieldbus Application main menu, double-tap **Online**. The Fieldbus Live Device List appears and indicates which device or host is acting as the LAS. The text *LAS* appears at the top of the screen only when the 375 Field Communicator is the LAS. See Figure 4-5.

If a live fieldbus device is connected to a host acting as the LAS, a precautionary message appears. The Live Device List is then displayed with key parameters from the connected device.

If an existing host control system or a device capable of being the LAS is not connected, the 375 Field Communicator acts as a temporary LAS on the segment and produces a warning message. After reading and following the message instructions, tap **OK** to display the Live Device List.

From the Live Device List, a Block List or a device menu is displayed for a device, depending on the device description.

Figure 4-5. Live Device List screen example

Tag	Address
3051REV6FF	35
LAS-> 375 Field Communicator	252

## Displaying the Block List

The Block List displays the block tag, block type, and actual mode of the device blocks. Consult your device manual or the Fieldbus Foundation for more information on blocks. FOUNDATION fieldbus menu trees will be on [www.fieldcommunicator.com](http://www.fieldcommunicator.com) as they become available.

To view the Block List:

1. From the Fieldbus Application main menu, double-tap **Online**.
2. Double-tap a device.

Figure 4-6. Block List screen example

The screenshot shows a window titled 'LAS' with a back arrow, a function key 'F', and a close button. Below the title bar, the text reads '3051 3051REV6FF' and 'Rosemount Device Revision 6'. A table with three columns is displayed: 'Block Tag', 'Block Type', and 'Actual Mode'. The table contains the following data:

Block Tag	Block Type	Actual Mode
RESOURCE	RES	00S
TRANSDUC...	Custom	00S
LCD	Custom	00S
FFAI1	AI	00S
FFAI2	AI	00S
FFPID1	PID	00S

Below the table is a 'HELP' button.

## Displaying a device menu

Some devices, depending on their device description, display a device menu rather than the Block List. A device menu displays the same parameters as the Block List, but they are organized by function rather than by block. Options such as Overview, Configure, Service Tools, and Advanced may appear. The Block List is still accessible from the Advanced option in a device menu.

The menu items displayed in the device menu vary because they are determined by the device description. Refer to your device manual or [www.fieldcommunicator.com](http://www.fieldcommunicator.com) for menu trees.

To view a device menu:

1. From the Fieldbus Application main menu, double-tap **Online**.
2. Double-tap a device.



## Modes

The resource, transducer, and all function blocks in the device have modes of operation. These modes govern the operation of the block. Every block supports both automatic (AUTO) and out of service (OOS) modes. Other modes may also be supported.

### Types of Modes

For the procedures described in this manual, it is helpful to understand the following modes:

#### AUTO

The functions performed by the block will execute. If the block has any outputs, these will continue to update. This is typically the normal operating mode.

#### MAN

In this mode, the output of the block can be manually overwritten for testing purposes.

#### Out of Service (OOS)

The functions performed by the block will not execute. If the block has any outputs, these will typically not update and the status of any values passed to other blocks will be "BAD". Before you make changes to the configuration of the block, change the mode of the block to OOS. When the changes are complete, change the mode back to AUTO.

### Other Types of Modes

Other types of modes are Cas, RCas, ROut, IMan and LO. For more information, see the Emerson Process Management, Rosemount Division Function Block manual, document 00809-0100-4783.

## Mode Parameters

Mode parameters are used to change the block mode from one state to another. There are four types of mode parameters: Target, Actual, Permitted, and Normal.

The Target mode is the mode that was assigned to a block and is used to change a block to a desired mode.

The Actual mode is the current mode of the block.

The Permitted mode lists the modes that are allowed for a block. Setting the Permitted modes prevents unauthorized changes to the operating mode of a block. To do this, configure the Block:Mode Permitted parameter to allow only the desired operating modes. It is recommended to always select OOS as one of the Permitted modes.

The Normal mode is the mode the block should be set to during normal operation conditions. Only the Permitted modes are displayed.

## Locate Mode Parameters

In the resource and transducer blocks, the mode parameters are normally found in the Process menu. In all other function blocks, they are found in the Common Config menu. The mode parameters will also be included in the All parameter list; see “Working with Device Blocks” on page 4-14.

You can view and edit the Target mode parameter by tapping the **MODE** button in the menus.

## ⚠ Change Modes

Whenever you need to change the parameters or properties of a block, you need to change the mode. A warning message may appear whenever the mode of any block is included in a list of parameter changes to be sent to a device.

To change the block mode:

1. Tap the **MODE** button in the Block Menu or device menu.
2. If prompted, select a block from the list and tap OK.
3. Uncheck the current mode. An asterisk (\*) symbol appears next to **Block Mode: Target** to indicate a change has been made to the Target mode. If the mode checkboxes are read-only, the block may have been set to allow only one mode.
4. Tap the checkbox next to a mode to select it as the new Target mode. A checkmark appears.
5. Tap **OK**.
6. When the warning message appears, thoroughly read it and tap **YES** to send the change to the device, or tap **NO** to cancel the operation. A Mode Change screen showing the Target mode and Actual mode are displayed until the Actual mode is updated. Tap **CLOSE** to close the Mode Change screen.

Figure 4-7. Device Block menu and Mode Screen

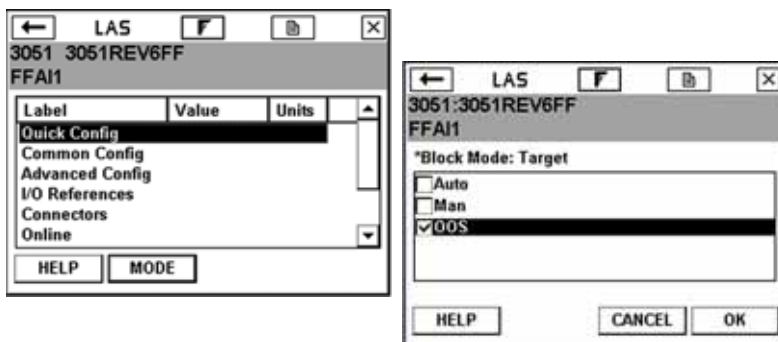

## Working with Device Blocks

The Block Menu is a submenu of the Block List. Block menus display block information for the fieldbus device to which you are connected.

The Block Menu is also available under the Advanced option in a device menu.

Devices that do not support transducer block menus within the device description will have the following selections: All, Process, Status, Other.

If methods are incorporated into the transducer block, they are displayed as either Diagnostic Methods or Calibration Methods.

Tap **All** to display all of the parameters for the desired block. It may take several minutes to display the parameters. It is recommended that you use this only if you are unable to find your desired selection elsewhere.

### Display the Block Menu

If the device description supports menus, you can display the Block Menu by performing the following steps:

1. From the Live Device List, double-tap a device to display the Block List. See page 4-10.
2. Double-tap the desired block tag. This displays the Block Menu.
3. From the Block Menu, double-tap the desired parameter group.

---

### NOTE

The block mode must be in the appropriate state to accept parameter changes. Typically, the mode is MAN or OOS.

---

### Parameter Functionality

Shaded areas indicate values that cannot be changed. You can edit only the resource, transducer, and I/O blocks. You can open and view all other blocks, however, you cannot edit them.

## Modified Parameters

An asterisk (\*) will appear next to a modified parameter that has not yet been sent to the device.

## Display Parameters

To display the parameters for fieldbus devices:

1. Display the Live Device List; see page 4-9.
2. Double-tap a device.
3. Double-tap the desired block, or the appropriate item from a device menu.
4. Double-tap the desired parameter group. The parameters and their current values are displayed. Shaded areas indicate values that cannot be edited.

## Change and Send Parameter Data

To change the values for parameters:

1. Display the parameters for the device.
2. Double-tap the desired parameter.
3. Change the value for the parameter.  
(Tap **HELP** to view a description of the parameter.)
4. Tap **OK** to acknowledge the parameter change. Repeat these steps for other parameters as necessary. A "\*" symbol indicates a parameter has been edited.
5. Tap **SEND** to commit your changes to the connected device.

## Display Device Status

To display device status:

1. Display the Live Device List; see page 4-9.
2. Double-tap a device.
3. Double-tap the desired block.
4. Double-tap **Status**. Status parameters are displayed.

## Run Methods

Select submenu choices as appropriate. Different devices have different methods associated with them, and the selections on these menus vary accordingly.

To run methods:

1. Display the Live Device List; see page 4-9.
2. Double-tap a device.
3. Double-tap the desired block (typically, methods are run in the transducer block).
4. Double-tap **Methods**.
5. Double-tap the type of method you want to run, for example, calibration, diagnostic, or sensor trim.  
Follow the navigation screens to run the method.

## Display the Details menu

To view the device details:

1. Display the Live Device List; see page 4-9.
2. Double-tap a device.
3. Double-tap **Advanced**.
4. Double-tap **Detail**. Double-tap one of the following options:

---

### NOTE

The physical device tag and address of a device will be read-only when, at a minimum, any of the following hosts/linking devices are detected on the segment: Rosemount 3420, DeltaV, Ovation, Allen-Bradley, Honeywell Experion PKS, or Yokogawa Stardom. To change the device tag or address, use the host system or remove the device from the segment and connect it directly to the 375 Field Communicator.

---

- **Physical Device Tag** designates a field device's identity in the system.
  - **Address** is the data link layer node address of the device. The host control system has the ability to assign an address to a device when it is connected to a segment. The following should be taken into consideration when assigning device addresses:
    - Valid device addresses for fieldbus devices are 20 through 247 with the exception of the addresses between V(FUN) and V(FUN) + V(NUN)-1 as defined for the 375; see "Configuring the Fieldbus Application" on page 4-21. These parameters are available in the Polling menu.
    - Addresses between 16 and 19 are usually reserved for host systems. A device should **not** be assigned in this address range.
    - Addresses below 16 are not available.
    - Addresses between 248 and 251 are temporary addresses. Devices without a tag or address will appear on the segment at these addresses.
    - Addresses between 252 to 255 are reserved for visitors, such as the 375 Field Communicator.
  - **Device ID** is the unique number identifier for each device. It is set by the device manufacturer and cannot be changed.
  - **Device Revision** is the manufacturer revision number. It is used by an interface device to locate the device description file for the resource and cannot be changed.
5. Using the SIP keyboard, enter the new information.
  6. Tap **OK**.

## Display Network Settings

To view the network parameters for the device or segment:

1. Display the Live Device List; see page 4-9.
2. Double-tap a device.
3. Double-tap **Advanced**.
4. Double-tap **Network Management**.
5. Double-tap the desired label to view the values.

Tap the **SAVE** button to save this as a text file. Transfer this file to a PC using the Easy Upgrade Programming Utility. The file appears in the User Data tab.

## Change the I/O Block Schedule

---

### NOTE

You cannot schedule I/O blocks when, at a minimum, any of the following hosts/linking devices are detected on the segment: Rosemount 3420, DeltaV, Ovation, Allen-Bradley, Honeywell Experion PKS, or Yokogawa Stardom. To schedule I/O blocks, use the host system or remove the device from the segment and connect it directly to the 375 Field Communicator.

---

To change the schedule:

1. Display the Live Device List; see page 4-9.
2. Double-tap a device.
3. Double-tap **Advanced**.
4. Double-tap **Schedule**. The I/O Block Schedule window appears. Changing the I/O Block Schedule would typically be done on the bench (not connected to a control system) when you want to execute an I/O block to verify that the outputs of the block are being computed correctly.
5. Using the drop-down menu, select the appropriate MacroCycle.
6. Tap the checkbox next to the I/O blocks that are to be scheduled.
7. Tap **OK**. This will schedule the blocks and set the mode on these blocks to Auto.
8. After reading the note, tap **OK** to acknowledge that the I/O blocks were successfully scheduled.



---

## Instantiate Blocks

The Instantiate Block menu lets you add function and transducer blocks to a connected device. This menu item appears only if the fieldbus device contains instantiable block types. After a block has been instantiated, the view displays the new block. The Actual mode of the new instantiated block will be set to OOS.

To instantiate a block:

1. Display the Live Device List; see page 4-9.
2. Double-tap a device.
3. Double-tap **Advanced**.
4. Double-tap **Instantiate Block**.
5. Tap the type of block that you want to add to the device.
6. Tap **OK** to add the block to the device. Tap **CANCEL** to exit the screen without adding a block.
7. When the warning message appears, tap **YES** to instantiate the block, or **NO** to cancel the operation.

---

### NOTE

You cannot instantiate or delete blocks when, at a minimum, any of the following hosts/linking devices are detected on the segment: Rosemount 3420, DeltaV, Ovation, Allen-Bradley, Honeywell Experion PKS, or Yokogawa Stardom. To instantiate or delete blocks, use the host system or remove the device from the segment and connect it directly to the 375 Field Communicator.

---

## Delete Instantiated Blocks

The Delete Block menu lets you delete instantiated blocks from a fieldbus device; you cannot delete permanent blocks. You can delete only one instantiated block at a time, and the Actual mode in the device must be set to OOS. If the Delete Block menu item is selected and no blocks have been instantiated in the device, an error message will appear. After a block has been deleted, the screen is refreshed and it does not display the deleted block.

To delete an instantiated block:

1. Display the Live Device List; see page 4-9.
2. Double-tap a device.
3. Double-tap **Advanced**.
4. Double-tap **Delete Block**.
5. Tap the block that you want to delete from the device.
6. Tap **OK**.
7. When the warning message appears, tap **YES** to delete the block, or **NO** to cancel the operation.

---

## NOTE

Some devices restart after a block has been instantiated or deleted, causing a loss in communication between the 375 Field Communicator and the device. After the device and 375 Field Communicator resume communication, the Live Device List is displayed.

---

## Displaying Graphics

The FOUNDATION Fieldbus Application offers graphical views of device data by using the enhanced Electronic Device Description Language (EDDL) technology. Device data can be presented as images, charts, and graphs. These options are displayed as items in the Online menu and its submenus. The placement of the Graphics options in the menus varies from device to device because it is determined by the device manufacturer.

To view the graphical representations, you need a device with enhanced EDDL, a 375 Field Communicator with a Graphics license, and 375 system software version 2.0 or higher. Only devices with enhanced EDDL offer graphical representations of data. If the 375 Field Communicator does not have a Graphics license, enhanced DDs can still be used. However, the graphical representations will not be displayed.

The Graphics license can be purchased through your 375 sales representative. The Graphics license can then be enabled in a 375 by using the Online Licensing feature in the Easy Upgrade Programming Utility. See Appendix C for more information about the Graphics functionality.

## CONFIGURING THE FIELDBUS APPLICATION

### Changing the Fieldbus Polling Addresses

Polling is a method of determining which devices are present on a network. The V(FUN) is the first unpolled node address. V(NUN) is the number of unpolled node addresses. The addresses between V(FUN) and V(FUN)+V(NUN)-1 are not polled. The default value for V(FUN) is 200 and the default value for V(NUN) is zero. Narrowing the range of devices being polled provides a quicker Live Device List refresh.

The DeltaV System Polling checkbox instructs the 375 Field Communicator to use the same polling scheme as DeltaV.

To change the polling addresses:

1. From the Fieldbus Application main menu, double-tap **Utility**.
2. Double-tap **Polling**.
3. Enter addresses in the V(FUN) and V(NUN) fields and tap **OK**.

### Changing the Slot Time

From the Fieldbus Utility menu, double-tap **Link Settings**. Select the default Slot Time of eight to allow the devices to be seen on the Live Device List. It may be necessary to change the Slot Time to 16 to view older devices on the 375 Field Communicator Live Device List.

## Viewing Available Device Descriptions

The Available Device Descriptions List menu lets you view all the device descriptions in the 375 Field Communicator. Fieldbus device descriptions enable the 375 Field Communicator to recognize and configure fieldbus devices.

To view the fieldbus device descriptions installed on the 375 Field Communicator:

1. On the Fieldbus Application main menu, double-tap **Utility**.
2. Double-tap **Available Device Description List**. The manufacturer names of the installed device descriptions are listed.
3. Double-tap the desired device manufacturer to expand the list. The models available for the manufacturer are listed.
4. Double-tap the desired device model. The device revisions available for the selected model are listed. One of the following icons will appear next to each device description to indicate its status:

 - A tested device description can be used with the system software version in the 375 Field Communicator.

 - An untested device description has not been formally tested for use with the system software version in the 375 Field Communicator. The device description can be used, but you may experience unexpected results.

 - An incompatible device description cannot be used with the system software version in the 375 Field Communicator.

## **RUNNING FIELDBUS DIAGNOSTICS**

The Fieldbus Diagnostics menu lets you run diagnostics for troubleshooting fieldbus networks and devices. You can check the DC voltage, the noise level at low frequencies, and the signal level and communication status. The selected tests are automatically repeated and the test results are updated in the Diagnostics Results screen.

To view the values associated with the status indicators or the possible causes of the values, run the diagnostic test, highlight the test on the Diagnostics Results screen, and tap **HELP**.

### **DC Voltage and Noise Level Measurement**

The DC voltage test displays the amount of DC voltage on a segment, and the noise level test displays the amount of noise on the segment. The word **Limit** is displayed if the DC voltage measurement is out of the -37 V to 37 V range or if the noise level measurement is greater than 2.2 V.

These tests display the measurement value, measurement unit, and one of the status indicators listed below.

**OK** - The value is within the acceptable range.

**High** - The value is greater than the normal values.

**Low** - The value is lower than the normal values. The noise level test will not display this status indicator.

**Error** - There is an error in the measurement or within the 375 Field Communicator.

### **Signal Level Measurement**

The signal level test determines if a 375 Field Communicator can receive signals from devices on a segment. To measure the fieldbus signal level, make sure an LAS is on the segment. Up to 16 different devices are checked. The word **Limit** is displayed if the signal level value is greater than 1.3 V.

This test displays the device address, measurement value, measurement unit, and one of the status indicators listed below.

√ - All signal responses from the device were received by the 375 Field Communicator.

! - Some signal responses from the device were received by the 375 Field Communicator. Signal responses may be missed due to noise on the segment.

X - No signal responses from the device were received by the 375 Field Communicator. This may be caused by noise on the segment.

**Error** - The measurement value is less than 75 mV or there is an error within the 375 Field Communicator.

Figure 4-8. Fieldbus Diagnostics screen examples

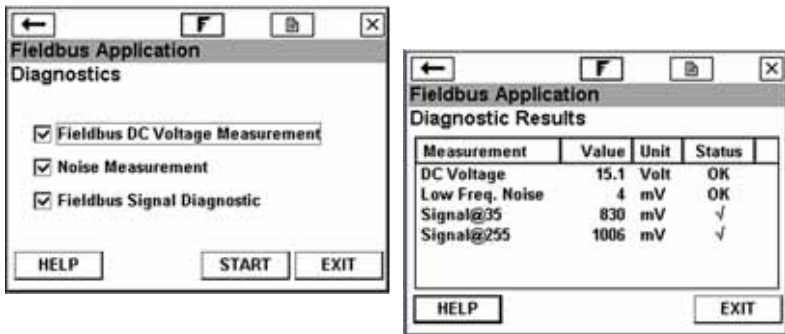

## DISCONNECTING FROM A FIELDBUS DEVICE

Prior to disconnecting or turning off the 375 Field Communicator, be sure to check the following items:

- Verify methods are complete.
- Resolve any un-sent data to the device.

## **SECTION 5 TROUBLESHOOTING**

### **OVERVIEW**

This section provides basic troubleshooting techniques for the 375 Field Communicator.

Below are methods for troubleshooting networks that are experiencing problems communicating between a field device and the 375 Field Communicator.

### **Troubleshooting Suggestions**

Answer the questions below and use the troubleshooting tables in this section before calling Technical Support personnel.

- Does the control system have HART or fieldbus communication capabilities?
- Is it configured to communicate HART or fieldbus currently? Is it reporting communication problems? If not, stop communications on the control system and re-test communication with the 375 Field Communicator.
- Is there a barrier installed?
- Is the barrier capable of passing along the signal?

## HART Loops

Verify the HART loop current and voltage on the field device. Almost all field devices need at least 4 mA and 12V DC to operate properly.

If there are multiple field devices on a multidrop loop, set the 375 Field Communicator to Poll by Address. See “Changing the HART Polling Option” on page 3-17 for more information on polling options.

Inspecting the loop wiring can often reveal problems. The shield is normally grounded at one end only, which is usually the control system.

Verify the loop has a minimum of 250 ohms resistance. If there is not an external resistor, then, normally, the total resistance is the resistance of the process-indicating device monitoring the loop. Check the manuals for the process-indicating device to determine its loop resistance. If the resistance of the process-indicating device is unknown, it can be determined by knowing the current flow in the loop and the voltage across the process-indicating device.

The resistance can be calculated using the formula, Resistance = Voltage / Current. The 375 Field Communicator can be used to measure the voltage; see “DC Voltage Measurement (HART Terminals)” on page 3-22.



## Sample values

Loop Current Flow Minimum voltage for 250 ohms.

4 mA 1 Volt

8 mA 2 Volts

12 mA 3 Volts

16 mA 4 Volts

20 mA 5 Volts

If the voltage across the process-indicating device is greater than the value listed for a given current flow, the device has at least 250 ohms of internal resistance. If the voltage is less than the value listed in the table for the given current flow, more resistance needs to be added to the loop.

If an oscilloscope is available, use it to look for noise on the loop. Use a scope with differential mode capability or a battery powered/isolated scope to avoid grounding one side of the loop. Noise with a frequency of 500 Hz to 10,000 Hz is of particular interest, as this represents frequencies near the HART frequencies of 1200 and 2200 Hz.

Table 5-1. Troubleshooting table for the HART protocol

Symptom	Possible Causes	Solution
Intermittent communication	Insufficient loop current and voltage at the field device terminals.	Verify there is at least 4 mA and 12V DC at the field device terminals; see "DC Voltage Measurement (HART Terminals)" on page 3-22.
	Noise on the field loop.  Noise or signal distortion from the control system (i.e., noise from the power supply powering the field devices or front end analog circuitry inside the control system may be distorting the HART signal.	
	Poor wiring.	Check wiring terminations and exposed signal wire for damage.
No communication with field device.	Insufficient loop resistance at the HART frequencies.	Add an additional 250 ohm resistor in series in the loop. Place the leads across the resistor and verify if communication has been restored.
	Insufficient loop current and voltage at the field device terminals.	Verify there is at least 4 mA and 12V DC at the field device terminals; "DC Voltage Measurement (HART Terminals)" on page 3-22.
	Field device may be set to a HART address other than zero (multidrop mode).	Change the polling mode to Poll by Address.
Control system is communicating HART, but the 375 is not communicating properly.	HART communication is being prevented by the control system.	Stop HART communications on the control system and verify if communication between the field devices and the communicator is restored.
A HART device appears at multiple addresses.	The incorrect polling addresses may be used.	Change the addresses being polled. See "Changing the HART Polling Option" on page 3-17.

Table 5-2. Troubleshooting table for the fieldbus protocol

Symptom	Possible Causes	Solution
No communication with field device.	The 375 is connected to a segment with DeltaV, and the device on the same segment is being commissioned using DeltaV.	The 375 is unable to communicate with this device until you go offline and then back online.
Connection to a segment in a bench configuration and the Live Device List remains blank (even the 375 Field Communicator does not appear).	This issue is caused by the speed at which certain LAS-enabled devices are attempting to run the segment.	Establish communication by putting the 375 on the segment first and then adding one or more devices. By putting the 375 on first, it will remain the LAS and control the communication.
Unable to change the address of a device.	The 375 is unable to change the address of a device that is currently the LAS.	Establish communication by putting the 375 on the segment first and then adding one or more devices. By putting the 375 on first, it will remain the LAS and allow the address change.
The 375 does not remain the LAS on a segment.	A host takes over as the LAS.	When a host is established on a segment, it will take over as the LAS. No action is required.
	A backup LAS takes over as the LAS. The lower the address and Slot Time of the device, the more likely this will occur.	See "Changing the Slot Time" on page 4-21.

## ERROR AND STATUS MESSAGES

General Error Messages	Description
License file check failed - error code x. Please contact service center to resolve this problem. Press <b>OK</b> to turn off. (Where x indicates the test that failed.)	License file check failed during power- up.
Communication circuit is not responding.	CDC is not responding during the power-up.
Warning: System incompatibility detected - error code x. Start Listen for PC and use the Easy Upgrade Programming Utility to resolve this, turn off your 375 and contact service center to resolve this. (Where x is an error code indicating what the incompatibility detected was or related errors.)	Hardware version or operating system is not compatible.
Installation file is corrupt - error code x. Please call service center to resolve this problem. Press OK to turn off.	The installation is corrupt.
The 375 needs to update its software. Battery power must be more than 20% to allow for this update. You must recharge the 375 battery, switch to a spare battery pack, or use external power. Press OK to turn off.	This message occurs when on battery power, and the battery percentage is less than 20% before attempting to launch program loader.
This 375 is not licensed for HART.	Your 375 is not licensed for HART functionality. Contact your sales representative for information on adding this functionality.
This 375 is not licensed for FOUNDATION Fieldbus.	Your 375 is not licensed for FOUNDATION fieldbus functionality. Contact your sales representative for information on adding this functionality.
This 375 is not licensed for Enhanced Graphics.	Your 375 is not licensed for the Graphics functionality. Contact your sales representative for information on adding this functionality.
The 375 does not detect a System Card. Please make sure your System Card is properly installed in its slot. Press OK to turn off.	This message occurs when the System Card is not properly installed in its slot or the System Card is missing.

HART Error Messages	Description
Hart Application Error... "hc.dll device revision x not found..."Refresh System Card...See User's Manual and Programming Interface for details.	An expected version of hc.dll is not found.
Hart Application Error... "registry failure"...Reinstall System Files...See User's Manual for details.	The information describing the location of the DDs is not found in the registry.
Voltage is currently detected at the Fieldbus Terminals. Reconfigure unit and try again.	The HART Application finds voltage on the fieldbus connector during initialization and during reconnection to a device.
CDC Error..."failure while switching to HART"...Reinstall System Files...See User's Manual for details.	The HART Application fails to put the CDC in HART mode for talking to a HART device.
DD Error..."tokenizer mismatch"...DD version <manufacture name, device name, dev. rev. #, and DD rev. #>; HART application <version x.y>; HART app version x.y...Reinstall DD...See Programming Interface for details.	The version of the tokenizer used to tokenize the DD is not what the HART Application expects.
DD Error..."linker mismatch"...DD version x.y; HART app version x.y...Reinstall DD...See Programming Interface for details.	The version of the linker used to link the DD is not what the HART Application expects.
DD Error..."developed-to mismatch"...DD version <manufacture name, device name, dev. rev. #, and DD rev. #>; HART application <version x.y> ...See Programming Interface for solution.	The DD was developed and tested using a later HART Application revision.
Warning: this DD is untested with the current Hart App ver <manufacture name, device name, dev. rev. #, and DD rev. #>...you may experience unexpected or inappropriate results...See Programming Interface for details on DD updates...Do you want to accept these risks and proceed?	The DD was not tested and verified with the HART Application.
DD Error..."tested-to sequence mismatch"...DD version <manufacture name, device name, dev. rev. #, and DD rev. #>; HART application <version x.y>; HART app version x.y...See Programming Interface for solution.	The DD was tested with a previous version, but not with this version of the HART Application.
DD Error..."developed-to mismatch"...DD version <manufacture name, device name, dev. rev. #, and DD rev. #>; HART application <version x.y>; HART app version x.y...Reinstall DD...See Programming Interface for details	The DD was developed using a later HART Application revision.
DD Error..."DD header file corrupted"...Reinstall Device version <manufacture name, device name, dev. rev. #, and DD rev. #>; HART application <version x.y> ...See Programming Interface for details.	There is a check sum error in the DD header file.
Hart Application Error..."data compression dll is missing"...Reinstall System Files...See User's Manual for details.	The data compression component cannot be located.

Hart Application Error..."data compression dll is corrupted"...Reinstall System Files...See User's Manual for details.	Required functionality is missing from the data compression component.
Memory Error..."data compression memory allocation error"...Restart Unit...See User's Manual for further details.	The HART Application is unable to acquire enough memory for data compression.
DD Error..."failure while opening DD"...Reinstall Device Type x Device Rev x dd Rev x...See Programming Interface for details.	The system cannot open the DD.
DD Error..."failure while uncompressing DD"...Reinstall Device revision <manufacture name, device name, dev. rev. #, and DD rev. #> ...See Programming Interface for details.	An error is detected while uncompressing the DD.
Communication Error..."unexpected return value"...See User's Manual for solution.	An unexpected value is returned from a function call.
DD Error..."DD file corrupted"...Reinstall Device revision <manufacture name, device name, dev. rev. #, and DD rev. #>...See the Programming Interface for details.	The checksum of the DD does not match with that described in the DD header file. This error may be corrected by connecting the 375 Field Communicator to the Easy Upgrade Programming Utility and running a Refresh operation.
Forward Compatibility Blocked...DD Device Type x Device Rev x dd Rev x cannot be used in forward compatibility mode...x... Do you wish to proceed in forward compatibility mode?	The HART Application attempts to use a DD to run in forward compatibility mode and finds that the DD is prevented from running in forward compatibility mode.
DD Not Installed...DD device type x device rev x is not installed on the System Card...See Programming Interface for details on DD updates...Do you wish to proceed in forward compatibility mode?	The DD for the connected device is not in the 375. If your System Card is licensed for Easy Upgrade, you can add DDs to your 375 from the Easy Upgrade Programming Utility.
Do you want to ignore this message while communicating with this device?	The HART Application lets you ignore some response code warning messages, such as Update Failure, while communicating with a device. The next time you communicate with the device, this message will appear.

Fieldbus Error Messages	Description
DDP Error 1: Unable to load DD. Press OK to return to Block List	Using the Easy Upgrade Programming Utility, check to see if this DD is available to load into your 375. If not, contact the device manufacturer.
There has been a loss of communication with one or more devices on the segment. Press OK to return to the Live Device List.	Check connection to fieldbus devices.
The 375 has been disconnected from the segment. Press RETRY to attempt to reconnect to the segment. Press CANCEL to return to the FF app main menu. Press EXIT to exit the FF App.	Verify that the 375 lead set is still securely connected to the FF Segment and tap RETRY.
SM ERROR: FAILED RESPONDER IDENTIFY	There is a problem sustaining communications with the device. Contact 375 Field Communicator Technical Support personnel.
FFLIB: Incompatible DD Static Description	The device description (DD) does not match the actual device correctly. Use the Easy Upgrade Programming Utility to see if a new DD is available for that device. Contact 375 Field Communicator Technical Support personnel.
FBLIB: Device Upload aborted	Communications with a device has timed out. This should normally not happen, unless a host was selected. Contact 375 Field Communicator Technical Support personnel.
FMS OTHER: Parameter Check	The parameter being entered is invalid for this device. Check with the device supplier. Make sure the value entered is valid for that specific device parameter.
FMS OTHER: Exceeds Parameter Limits	The parameter being entered is outside the range of valid values for the device parameter. Check with the device supplier. Make sure the value entered is in the correct range for that device parameter.
FMS OTHER: Wrong Mode For Request	The block is in the wrong mode to accept the parameter change being requested. See "Change Modes" on page 4-13 for information on how to change block modes.
SM ERROR: REMOTE ERROR INVALID STATE	An attempt to change the address of the device serving as the LAS on the segment is being made. Changing the device address of the LAS is not recommended.
DD Error... "DD file corrupted"...Reinstall Device revision <manufacture name, device name, dev. rev. #, and DD rev. #>...See the Programming Interface for details.	The checksum of the DD does not match with that described in the DD header file. This error may be corrected by connecting the 375 Field Communicator to the Easy Upgrade Programming Utility and running a Refresh operation.

**REQUIRED  
INFORMATION  
FOR  
TECHNICAL  
ASSISTANCE**

Before you call Technical Support personnel, have the User's Manual for the field device and a detailed description of the issue, including the following information (if applicable):

- Manufacturer and model of control system (if applicable).
- 375 Field Communicator system software revision.
- Manufacturer ID number or name and model revision of field device (as displayed on the 375 Field Communicator, exact spelling if possible.)
- Does communication work when certain devices or processes are not running?
- What is the total cable length run from the termination panel to the field device?
- What is the message on the 375 Field Communicator when attempting to communicate with a field device (e.g., device not found)?
- What is the serial number of the 375 Field Communicator having the communication issue?
- Is the device in burst mode?
- What is the loop impedance in the device loop? (resistance value)
- Can the 375 Field Communicator talk to the field device?
- Can AMS Device Manager talk to the field device?
- Is the field device address set to "0"?
- Is there more than one field device on the loop?
- Is there another master (primary or secondary) on the loop? (i.e., control system, multiplexer, etc.)
- Does the control system support HART or fieldbus communications?
- If a HART multiplexer is being used, what is the manufacturer and model?
- What is the approximate field device loop length? (length of the wire)
- Are there any error messages being displayed?
- What task is being performed when the communication problem occurs?
- Are you having communication problems with multiple field devices?

**Contacting Technical Support Personnel**

Contact your supplier or go to <http://www.fieldcommunicator.com/supp.htm> for Technical Support contact information.



## APPENDIX A REFERENCE INFORMATION

### PROCESSOR AND MEMORY SPECIFICATIONS

**Microprocessor** 80 MHz, max 133 MHz Hitachi® SH3

**Memory**

**Internal Flash**

32 MB

**System Card**

1 GB Secure Digital card

**RAM**

32 MB

**Expansion Module**

32 MB (or higher) Secure Digital card

**PHYSICAL  
SPECIFICATIONS****Weight**

Approximately 2 lb. (950 grams) includes battery

**Display**

1/4 VGA (240 by 320 pixels) monochrome touch screen with a viewing area of approximately 6 cm by 8 cm (10 cm diagonal)

Base glass thickness 1.1 mm anti-glare

Dimensions 92 mm x 71.1 mm x 10 mm

**Keypad**

Twenty-five keys including four action keys, twelve alphanumeric keys, four alternate functionality keys, On/Off key, and four navigation (arrow) keys; membrane design with tactile feedback

**Enclosure rating**

IP51 (front)

**Shock**

Passes the 1-meter drop test onto concrete

**CONNECTION  
SPECIFICATIONS****Power supply/charger**

Green 6-pin mini din (male) plug

**NiMH Adapter Cable**

Green 6-pin mini din (female) plug on one end

Black 4-pin mini din (male) plug on the other end

**HART and Fieldbus Communication Terminals**

Three 4mm banana plugs (one common terminal to both HART and FOUNDATION fieldbus.)

**Personal computer**

IrDA port supporting up to 115 Kb/s

± 15 degrees recommended maximum angle from center line

18 in. recommended maximum distance from center line

<b>POWER SUPPLY/ CHARGER SPECIFICATIONS</b>	<b>Voltage</b> 6.0 V 100-240 VAC, 50/60Hz, US/UK/EU connection types included
---	--

### Technical data

Input voltage	100 - 240 VAC $\pm$ 10%
Input current	750 mA max.
Standby current	20 mA max.
Input fuse type	TES 2A 250 V Timelag
Output voltage 1	0 - 8.3 VDC
Output current 1	1000 mA max.
Output voltage 2	0 - 9 VDC
Output current 2	1400 mA max.
Output power rating	20 W
Operating temperature	0°C - +40°C
Storage temperature	-20°C -+80°C
Measurements [L x B x H]	112 mm x 51.5 mm x 29.5 mm
Total Mass	240 g.

**BATTERY  
SPECIFICATIONS****Nickel-Metal Hydride (NiMH) Battery Pack**

Five rechargeable NiMH AA batteries, not serviceable  
Black 4-pin mini din (female) jack

**NiMH Battery Pack operating time**

5 hours when backlight is set to highest setting  
9 hours when backlight is off  
43 hours when using stand-by without backlight

**Lithium Ion (Li-Ion) Power Module**

Two rechargeable Li-Ion cells, not serviceable  
Green 6-pin mini din (female) jack

**Li-Ion Power Module operating time**

12 or more hours when backlight is set to highest setting  
21 or more hours when backlight is off  
72 or more hours when using stand-by without backlight

**TEMPERATURE  
SPECIFICATIONS****375 Field Communicator Use**

-10°C to +50°C (+14°F to +122°F)  
0% to 95%RH (non-condensing) for 0°C to +50°C  
(+32°F to +122°F)

**375 Field Communicator storage without  
battery**

-20°C to +60°C (-4°F to +140°F)

**375 battery charge**

5°C to +35°C (+41°F to +95°F)

**375 battery storage**

-20°C to +55°C (-4°F to +131°F)  
(less than one month)

It is recommended to use a location at room temperature  
or cooler when storing a battery for an extended time.

## ORDER INFORMATION

<b>Model</b>	<b>Product Description</b>
375	Field Communicator <b>(Note 1)</b>
<b>Code</b>	<b>Communication Protocol</b>
H	HART
F	HART and FOUNDATION fieldbus <b>(Note 2)</b>
<b>Code</b>	<b>Battery Type (Note 6)</b>
R	Rechargeable NiMH Battery Pack
P	Rechargeable Li-ion Power Module
<b>Code</b>	<b>Power Supply/Charger (Note 3)</b>
1	Power Supply/Charger (Li-ion/NiMH) (100-240 VAC, 50/60Hz, US/UK/EU connection types included)
9	Not Included <b>(Note 4)</b>
<b>Code</b>	<b>Language</b>
E	English
<b>Code</b>	<b>Product Certifications</b>
KL	ATEX, FM, CSA and IECEx Intrinsically Safe (includes FISCO as applicable)
NA	No Approval
<b>Code</b>	<b>Easy Upgrade</b>
U	Easy Upgrade Option (3 year) <b>(Note 5)</b>
9	Not Included
<b>Code</b>	<b>Options</b>
	<b>Spare Battery</b>
B	Spare Rechargeable NiMH Battery Pack <b>(Notes 6 and 9)</b>
A	Spare Rechargeable Li-ion Power Module <b>(Notes 6 and 10)</b>
	<b>Expansion Module</b>
C	Configuration Expansion Module <b>(Note 7)</b>
	<b>Additional License Options</b>
G	Graphics Option <b>(Notes 2 and 8)</b>
<b>Typical HART Model Number: 375 H P 1 E KL U</b>	
<b>Typical HART/Foundation Model Number: 375 F P 1 E KL U</b>	

- (1) *Base Model 375 includes Field Communicator unit, System Card, Lead Set with Connectors, Carrying Case, Getting Started Guide, User's Manual, 375 Resource CD, Stylus and Straps.*
- (2) *This option requires that you also specify the Easy Upgrade option (code U).*
- (3) *To obtain an Australian Power Cord, order part number 00375-0003-0003.*
- (4) *This option should only be considered if the user already has a 375 Power Supply/Charger that supports the Battery Type he or she is ordering.*
- (5) *The Easy Upgrade feature allows the user to add new System Application software and device descriptions (DDs) to the 375 for a period of 3 years. To upgrade without this feature, the System Card would have to be sent to a Service Center (fee would apply).*
- (6) *A fully charged Li-ion Power Module is capable of delivering 2x the capacity of the NiMH Battery Pack. This translates to 16-20 hours of typical field use for the Li-ion and 8-10 hours for NiMH. If requirements exceed this specification, a Spare Battery (code B or A) of a corresponding type should be ordered.*
- (7) *The 375 is capable of storing a total of 25 configurations. For increased storage capacity, specify the Configuration Expansion Module (code C), which is capable of storing in excess of 500 configurations.*
- (8) *The Graphics option enables a user to access enhanced Graphical features when using the HART or FOUNDATION fieldbus applications, (as applicable).*
- (9) *Option available with NiMH Battery Type (code R) only.*
- (10) *Option available with Li-ion Battery Type (code P) only.*

## SPARE PARTS LIST

Description	Part Number
Ruggedized 250 Ohm Load Resistor	00275-0096-0001
Rechargeable NiMH Battery Pack with Accessory Case	00375-0002-0011
Rechargeable Li-Ion Power Module with Accessory Case ( <b>Note 1</b> )	00375-0002-0022
Rechargeable Li-Ion Power Module with Power Supply/Charger (Combo Pack)	00375-0002-0044
NiMH Battery Pack Adapter Cable ( <b>Note 2</b> )	00375-0003-0008
Power Supply/Charger (Li-Ion/NiMH) (100-240 VAC, 50/60Hz, US/UK/EU connection types included) ( <b>Note 3</b> )	00375-0003-0022
Lead Set with connectors	00375-0004-0001
Mounting Straps	00375-0005-0002
Carrying Case (with straps)	00375-0005-0003
Accessory Case (clips to Carrying Case)	00375-0005-0004
Stylus (pack of 5)	00375-0006-0001
IrDA to USB Adapter ( <b>Note 4</b> )	00375-0015-0002
System Card (SD) Reader (with USB interface) ( <b>Note 5</b> )	00375-0018-0022
Expansion Port Plug	00375-0035-0001
System Card - HART with <i>Easy Upgrade</i> (3 years) Option ( <b>Note 6</b> )	00375-0042-0003
System Card - HART and FOUNDATION fieldbus with <i>Easy Upgrade</i> (3 years) Option ( <b>Note 6</b> )	00375-0042-0004
System Card - HART with <i>Easy Upgrade</i> (3 years) Option and Graphics ( <b>Note 6</b> )	00375-0042-0013
System Card - HART and FOUNDATION fieldbus with <i>Easy Upgrade</i> (3 years) Option and Graphics ( <b>Note 6</b> )	00375-0042-0014
Configuration Expansion Module	00375-0043-0001
Stand and Utility Plate	00375-0044-0001
Getting Started Guide	00375-0045-0001
User's Manual	00375-0047-0001
Resource CD	00375-0049-0001
<b>375 Online Licensing (Note 7)</b>	
FOUNDATION fieldbus license via Web	00375-0142-0002
Easy Upgrade (New) license via Web ( <b>Note 6</b> )	00375-0142-0003
Easy Upgrade (Renew) license via Web ( <b>Notes 6 and 8</b> )	00375-0142-2003
Graphics license via Web	00375-0142-0010
<b>AMS Device Manager Handheld Interface Kit (Note 9)</b>	
AMS Suite: Intelligent Device Manager Handheld Communicator Interface Kit (25 tags)	AW7005HC00025
AMS Suite: Intelligent Device Manager Handheld Communicator Interface Kit (100 tags and above)	AW7005HC20000

- (1) *Requires Power Supply/Charger 00375-0003-0022. It will not work with the older style of charger 00375-0003-0011.*
- (2) *Required when charging the NiMH Battery Pack with the new charger style. An adapter is included with each 00375-0003-0022 Power Supply/Charger.*
- (3) *To obtain an Australian Power Cord, order part number 00375-0003-0003.*
- (4) *Can be used to support communication between the 375 and the Easy Programming Utility or AMS Suite: Intelligent Device Manager (with Handheld Communicator Interface Kit). IrDA communication is required to Register the 375 or use the Online Licensing system.*
- (5) *The System Card (SD) reader allows a user the ability to upgrade a System Card much faster than they can when using IrDA. The ability to use a card reader is available starting with Easy Upgrade Programming Utility 1.6.0 (or higher). Due to file size constraints, some upgrades require the use of a card reader (e.g., upgrading from System Software version 1.x to 2.x).*
- (6) *The Easy Upgrade feature allows the user to add new System Software and device descriptions (DDs) to the 375 for a period of 3 years. To upgrade without this, the System Card would have to be sent to a Service Center (fee would apply).*
- (7) *These parts support license upgrades of System Cards in the field through the use of the 375 Online Licensing system. The capability is available to users, but it may also be performed by an agent on the user's behalf. Any order must be accompanied by the System Card S/N. Instant notification of when the licenses are available for download can be provided to any email address provided at the time of order. For further details, see the Online Licensing procedure at [www.fieldcommunicator.com](http://www.fieldcommunicator.com).*
- (8) *The ReNew option is available on System Cards where the Easy Upgrade license has been expired for less than 90 days. Date of expiration can be obtained by interfacing the 375 with version 1.6.0 (or higher) of the Easy Upgrade Programming Utility.*
- (9) *Requires AMS Suite: Intelligent Device Manager (version 6.2 or higher). Both AMS Device Manager and the Handheld Communicator Interface Kit are available for sale through select channels only. See [www.ams.assetweb.com](http://www.ams.assetweb.com) for further details.*



## APPENDIX B PRODUCT CERTIFICATIONS

### OVERVIEW

All 375 Field Communicators come with the main unit label (see Figure B-1). Intrinsically Safe (IS) (KL option) 375 Field Communicators also have an additional label opposite the main unit label. If the 375 Field Communicator does not contain this label (NA option), then it is considered non-IS approved.

### APPROVED MANUFACTURING LOCATIONS

Emerson Process Management —  
Leicester, England

### EUROPEAN DIRECTIVE INFORMATION

#### CE Compliance

##### Electro Magnetic Compatibility (2004/108/EC)

Tested to specifications EN 61000-6-3,  
EN 61000-6-2, and EN 61326-1

##### ATEX Directive (94/9/EC) (KL option only)

Emerson Process Management complies with the  
ATEX Directive.

Specific ATEX Directive Information is located within  
this section and in the 375 Field Communicator  
Getting Started Guide. See "Power Supply/ Charger  
Certification" on page B-4 for more information.

Applicable standards EN 60079-0, EN 60079-11, and  
EN 60079-26.

**Other important guidelines**

Only use new, original parts.

Do not charge the battery in hazardous areas.

Have repairs done only by qualified personnel.

Only charge or power using the 375 power supply/charger.

**HAZARDOUS  
LOCATIONS  
CERTIFICATIONS  
(KL OPTION  
ONLY)****International  
Certifications****IECEX**

Certification No.: IECEX BVS 08.0044

Ex ia IIC T4 (-10°C ≤ Ta ≤ +50°C)

**North  
American  
Certifications****Factory Mutual (FM)**

Intrinsically Safe for Class I, Division 1, Groups A, B, C, and D and Class I, Zone 0, AEx ia IIC T4

(Ta = 50°C) hazardous locations when connected as indicated in the control drawing 00375-1130. See the control drawing for input and output parameters.

**Canadian Standards Association (CSA)**

Intrinsically safe for use in Class 1, Zone 0, Ex ia IIC T4 (Ta = 50°C) hazardous locations when connected as indicated in the control drawing 00375-1130. See the control drawing for input and output parameters. Please note the parameters in the control drawing are the same as the FM parameters.

## European Certifications

### ATEX Intrinsic Safety

Certification No.: BVS 03 ATEX E 347  II 2 G  
(1 GD)

Ex ia IIC T4 (-10°C ≤ Ta ≤ +50°C)  1180

### HART Intrinsically Safe electrical parameters

#### Input Parameters

$U_i = 30$  Volt DC

$I_i = 200$  mA

$P_i = 1.0$  Watt

$L_i = 0$

$C_i = 0$

#### Output Parameters

$U_o = 1.9$  Volt DC

$I_o = 32$  μA

### FOUNDATION fieldbus

#### Intrinsically safe FISCO

$U_{iIIC} = 17.5$  Volt DC     $I_{iIIC} = 215$  mA     $P_{iIIC} = 1.9$  Watt

$U_{iIIB} = 17.5$  Volt DC     $I_{iIIB} = 380$  mA     $P_{iIIB} = 5.3$  Watt

$U_o = 1.9$  Volt DC     $I_o = 32$  μA

#### Intrinsically safe Non-FISCO

$U_i = 30$  Volt DC     $I_i = 380$  mA     $P_i = 1.3$  Watt

$U_o = 1.9$  Volt DC     $I_o = 32$  μA

$L_i = 0$      $C_i = 0$

## POWER SUPPLY/ CHARGER CERTIFICATION

### Declaration of Conformity/Approvals

The 375 Field Communicator charger/power supply complies to the requirements of the relevant EU directives. The conformity assessment process has been successfully completed as per the directives listed below.

LOW VOLTAGE DIRECTIVE 73/23/EEC AMENDED BY 93/68/EEC.

EN 60950:2000

EMC DIRECTIVE 2004/108/EC AMENDED BY 91/263/EEC, 92/31/EEC, THE FOLLOWING HARMONIZED STANDARDS WERE APPLIED, IMMUNITY EN 61204-3:2000

All conformity information for this product can be accessed at [www.fieldcommunicator.com/techcert.htm](http://www.fieldcommunicator.com/techcert.htm)

## LABEL DRAWINGS

Figure B-1. All 375 Field Communicators will have a similar label to the one below.

**Label 1-1**  
**ZN:2003 06 50 2**

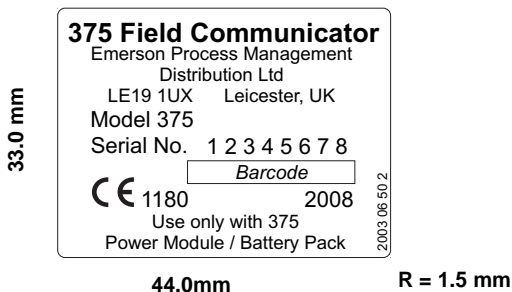

Figure B-2. Approval Ex label example (KL option only)

**Label 1-2**  
**ZN:2003 06 51 2**

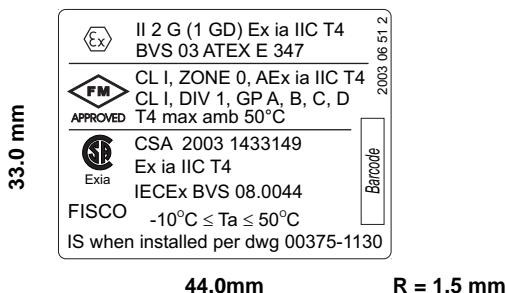
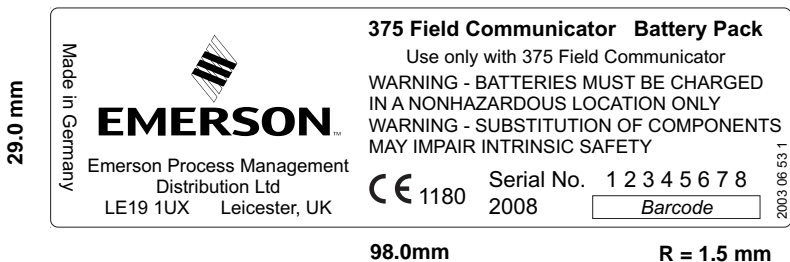

Figure B-3. Battery Label examples. Some labels appear on only certain battery types. The corresponding battery type for each label is listed below the label number.

**Label 4-1**  
**ZN:2003 06 53 1**  
**Appears on NiMH Battery Packs**



**Label 4-1\_PM-1**  
**ZN:2008 16 53 0**  
**Appears on Li-Ion Power Modules**

29.0 mm

Made in Germany



**EMERSON™**  
 Emerson Process Management  
 Distribution Ltd  
 LE19 1UX Leicester, UK

**375 Field Communicator Power Module**  
 Use only with 375 Field Communicator  
 Charge only with Charger 00375-0003-002x  
**WARNING - BATTERIES MUST BE CHARGED  
 IN A NONHAZARDOUS LOCATION ONLY**  
**WARNING - SUBSTITUTION OF COMPONENTS  
 MAY IMPAIR INTRINSIC SAFETY**

Serial No. 1 2 3 4 5 6 7 8  
 2008 Barcode

2008 16 53 0

98.0mm

R = 1.5 mm

**Label 4-2**  
**ZN:2003 06 54 2**  
**Appears on Li-Ion Power Modules and NiMH Battery Packs**

10.0 mm

2003 06 54 2

II 2 G (1 GD) Ex ia IIC T4  
 BVS 03 ATEX E 347  
 -10°C ≤ Ta ≤ 50°C  
 IECEx BVS 08.0044

  
 APPROVED  
 T4 max amb 50°C  
 Ex ia IIC T4

IS for CL I, ZONE 0, AEx ia IIC T4  
 CL I, DIV 1, GP A, B, C, D  
 CSA 2003 1433149

  
 Exia

2008 16 54 0

70.0mm

R = 1.5 mm

**Label 4-4**  
**ZN:2008 16 54 0**  
**Appears on 375 Li-Ion Power Modules**

33.0 mm

**WARNING**

Li-Ion Rechargeable battery for  
 375 Field Communicator.

Do not heat the battery or throw it into fire.  
 Do not charge, use and leave the battery  
 at the high temperature.  
 Do not deform, short-circuit, disassemble  
 and modify the battery.

Do not allow the battery to be immersed in  
 or wetted with water or sea-water.  
 Do not subject the battery to a strong  
 impact or throw it.

May cause heat, explosion and fire.

2008 16 54 0

44.0mm

R = 1.5 mm

# APPROVAL DRAWINGS

This approval drawing can also be found on the [www.fieldcommunicator.com](http://www.fieldcommunicator.com) website.

TABLE 1 - FM ENTRY PARAMETERS

Test Parameter Type	Value	Digital Parameter
Max. Ambient Temp	50°C	Class: 30°C
Min. Ambient Temp	-40°C	Class: 30°C
Max. Humidity	95% RH	Class: 30°C
Min. Humidity	5% RH	Class: 30°C
Max. Altitude	3000m	Class: 30°C
Min. Altitude	0m	Class: 30°C
Max. Vibration	0.5g	Class: 30°C
Min. Vibration	0g	Class: 30°C
Max. Shock	10g	Class: 30°C
Min. Shock	0g	Class: 30°C

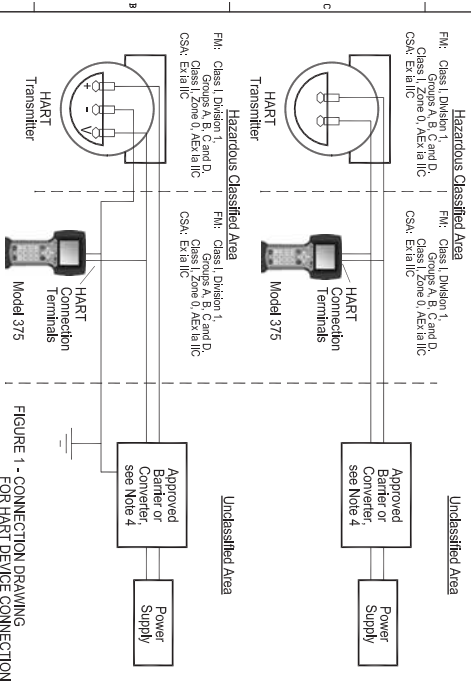

FIGURE 1 - CONNECTION DRAWING FOR HART DEVICE CONNECTION

**WARNING - BATTERIES MUST BE CHARGED IN A NONHAZARDOUS LOCATIONS ONLY**  
**WARNING - SUBSTITUTION OF COMPONENTS MAY IMPAIR INTRINSIC SAFETY**

- Notes:**
1. Not applicable to the drawing shown prior to FM Approval.
  2. Associated Apparatus must be approved by the Authority Having Jurisdiction (AHJ).
  3. Associated Apparatus must be approved by the Authority Having Jurisdiction (AHJ).
  4. The Associated Apparatus must be FM Approved.
  5. Model 375 Communicator.
  6. Installation should be in accordance with the applicable code and standards for intrinsically safe systems for Hazardous Classified Locations and associated equipment.
  7. Control equipment connected to Associated Apparatus must not use or operate more than 250V Ground and Earth.
  8. Ground must be less than 1.0 Ohm.
- CSN:**
1. The Associated Apparatus must be CSA certified.
  2. Model 375 Communicator must be CSA certified for use with the Model 375 Communicator.
  3. Model 375 Communicator must be CSA certified for use with the Model 375 Communicator.
  4. Code: CSA 221, Part 1.
  5. Used by Associated Apparatus.
  6. Resistance between Intrinsic Safe Ground and Earth Ground must be less than 1.0 Ohm.

DATE OF ORIGINAL SPECIFICATION	XX/XX/XX
DATE OF REVISION	XX/XX/XX
DATE OF MODIFICATION	XX/XX/XX
DATE OF FINAL SPECIFICATION	XX/XX/XX

DESIGN ENGINEER	DATE
DESIGN CHECKER	DATE
PROJECT MANAGER	DATE
PROJECT ENGINEER	DATE
PROJECT SUPERVISOR	DATE
PROJECT ASSISTANT	DATE

MODEL 375	DATE
INSTALLATION DRAWING	DATE
DATE	DATE
DATE	DATE
DATE	DATE
DATE	DATE
DATE	DATE
DATE	DATE
DATE	DATE
DATE	DATE
DATE	DATE
DATE	DATE

REV. NO. 00375-1130 SHEET 1 OF 4

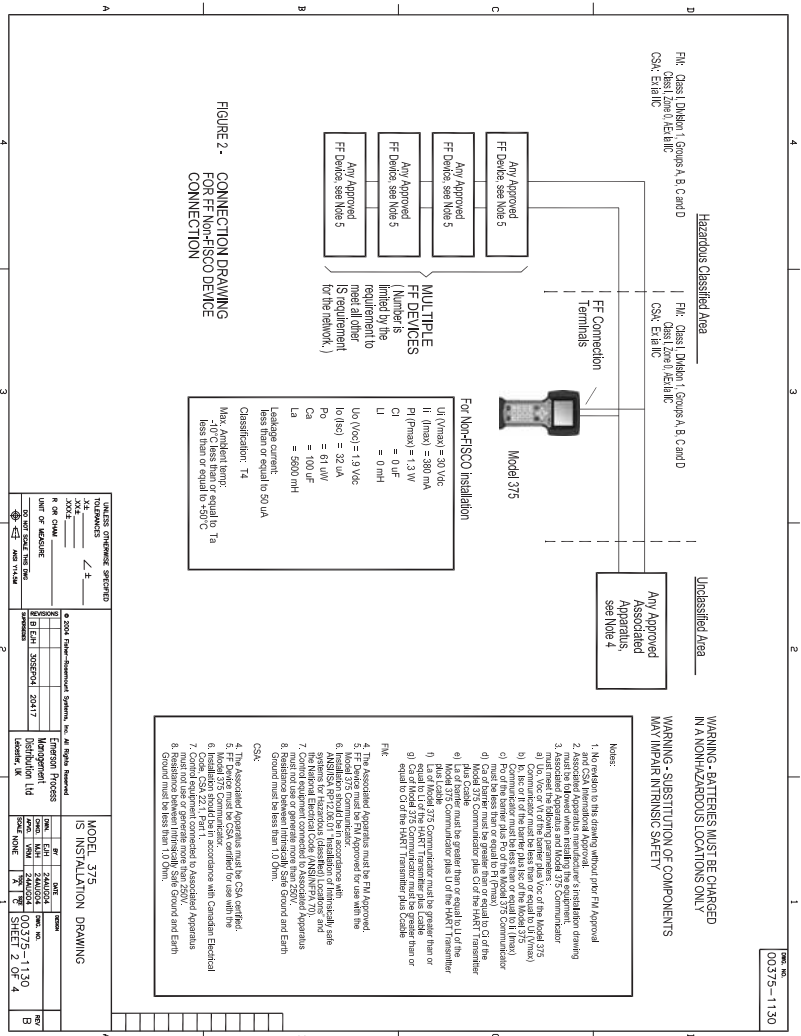

FIGURE 2. CONNECTION DRAWING FOR FF Non-ISCO DEVICE

**WARNING - BATTERIES MUST BE CHARGED IN A NON-HAZARDOUS LOCATION ONLY**  
**WARNING - SUBSTITUTION OF COMPONENTS MAY IMPAIR INTRINSIC SAFETY**

**Notes:**

1. No reduction to this drawing without prior FI Approval
2. Associated Apparatus manufacturer's installation drawing must be obtained when installing this equipment.
3. Associated Apparatus must be FI approved for the environment that would be the following parameters:
  - a) Location: Class 1, Div 1 or Class 1, Div 2
  - b) IEC or IEC of the battery plus IEC of the Model 375
  - c) Po of the battery plus Po of the Model 375 Communicator
  - d) Category: must be equal to or greater than CI of the Model 375 Communicator plus CI of the HART Transmitter
  - e) Level of number: must be greater than or equal to U of the Model 375 Communicator plus U of the HART Transmitter
  - f) IEC of Model 375 Communicator must be greater than or equal to IEC of the HART Transmitter plus IEC of Model 375 Communicator must be greater than or equal to CI of the HART Transmitter plus CI of the HART Transmitter

**FILE**

4. The Associated Apparatus must be FI Approved.
5. FF Device must be FI Approved for use with the Associated Apparatus.
6. Insulation should be in accordance with applicable standards for hazardous (classified) locations and systems for hazardous (classified) locations and non hazardous electrical codes (ANSI/NFPA 70).
7. Must not use or operate more than 250V<sub>ac</sub> Apparatus.
8. Ground must be less than 1.0 Ohms.
9. Ground must be less than 1.0 Ohms.

**CSK:**

1. The Associated Apparatus must be CSA certified.
2. FI Approved CSK must be used for the Model 375 Communicator.
3. The Associated Apparatus must be CSA certified.
4. Model 375 Communicator, in accordance with Canadian Electrical Code, CSA 22.1, Part 1.
5. The Associated Apparatus must be CSA certified.
6. Resistance between intrinsically Safe Ground and Earth Ground must be less than 1.0 Ohms.

INDICES CHANGES SPECIFIED

NO.	DATE	BY	REASON
1	2008	JAC	NEW
2	2011	JAC	REVISED

© 2011 Fisher-Substation Systems, Inc. All Rights Reserved

PROJECT	EMERSON PROCESS MANAGEMENT
PROJECT NO.	2011-17
DATE	2011-11-17
BY	JAC
CHECKED	JAC
DATE	2011-11-17

MODEL 375 IS INSTALLATION DRAWING

NO.	DATE	BY	REASON
1	2011	JAC	NEW
2	2011	JAC	REVISED

00375-1130  
 SHEET 2 OF 4

FORM 50  
 00375-1130







## APPENDIX C GRAPHICS INFORMATION

### OVERVIEW

The Graphics functionality enables a new, sleek user interface design by using enhanced Electronic Device Description Language (EDDL) capabilities. You can now view HART or fieldbus device information as images, charts, and graphs.

To view the graphical representations, you need a device with enhanced EDDL, 375 system software version 2.0 or higher, and a 375 Field Communicator with a Graphics license, which can be enabled in your 375 Field Communicator from the Easy Upgrade Programming Utility. See the Easy Upgrade Programming Utility online Help for more information.

The following sections provide details on the screen layout, the buttons used to modify the graphics, and the graphics options.

## SCREEN LAYOUT

A 375 Field Communicator has four elements on a screen. The Command Bar is a row of icons on the top of the screen. The Tag Bar displays the device type and device tag of the connected device. The buttons let you modify the appearance of a screen by panning, zooming, or resetting the screen. The **HELP** Softkey lets you view information about the graphics displayed on the screen.

Figure C-1. 375 Field Communicator screen layout

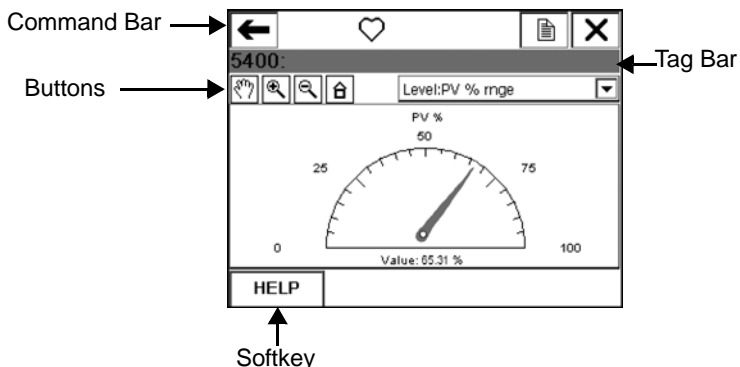

## BUTTONS

Use the following buttons to modify the appearance of the graphs and charts on your screen:



**Pan** - Tap this button, select a point in the chart, and drag to move the chart back and forth in the window.



**Area zoom** - Tap this button, then tap and drag a point in the chart to create an enlarged box. Once you release your stylus from the window, the chart enlarges to fit the area. This control is available on strip charts and graphs only.



**Zoom in** - Tap this button to zoom in at a fixed rate from the center of the chart. Tap again to repeat the action.



**Zoom out** - Tap this button to zoom out at a fixed rate from the center of the chart. Tap again to repeat the action.



**Reset** - Tap this button to return the chart to its original home view, removing any panning or zooming you may have performed.



**Drop-down menu** - Tap this menu to select between different variables to highlight on the chart.

## GRAPHICS OPTIONS

### Images

An image is a full screen display of a device. Images can include logos and various graphics, such as tanks. To view the image, select the image label in the menu. The full screen image is shown. To return to the menu view, press any key or tap the touch screen.

Figure C-2. Image example

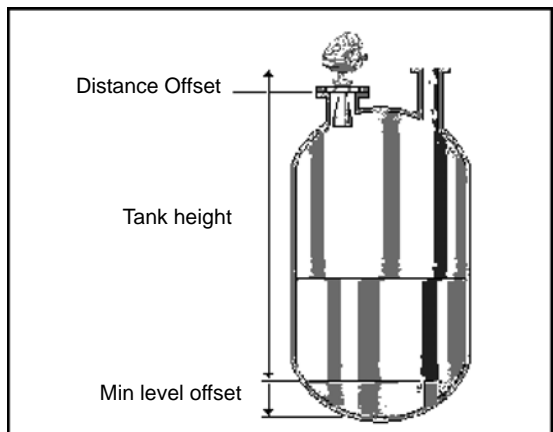

## Charts

Charts let the device descriptions display a graphic view of variables as they occur over time. There are four major types of charts:

- Strip/sweep/scope - Displays variable data with an x-axis of time.  
A strip chart continually updates the chart, scrolling from right to left.  
  
A scope/sweep chart paints the screen from left to right, and then paints the screen from left to right again, overwriting the oldest data.
- Horizontal bar - Displays data represented as bars from left to right.
- Vertical bar - Displays data represented as bars from bottom to top.
- Gauge - Displays a gauge chart, similar to an analog car speedometer.

---

### NOTE

If a chart is displayed for an extended time period, the 375 Field Communicator will have decreased response time due to the large number of data points in the chart.

---

## Strip/sweep/scope charts

The strip/sweep/scope chart formats device data into a line chart that displays device data over time. The command bar shows the back arrow icon, HART heartbeat or fieldbus logo, LAS indicator (fieldbus devices only), ScratchPad icon, and terminate icon. The tag bar shows the device type and device tag. The values, labels, and axis displayed are determined by the device manufacturer.

The **HELP** softkey appears if there is help associated with the particular selection. Use the buttons to pan, zoom, and reset the chart. Use the left arrow button on the 375 Field Communicator or the back arrow icon on the screen to close the chart view and return to the previous menu.

Use the drop-down menu to select the variable you want to display. The selected variable is the darkest line in the chart. Other variables that share the same source or same axis appear in a lighter shade of grey on the chart. Variables that do not share the same axis appear with a dashed line.

The time shown on the x-axis starts at the time the chart starts. The default value for time is 10 minutes.

The chart update rate is determined by the device manufacturer. The default chart update rate is 1 second.

Figure C-3. Strip/Sweep/Scope chart example

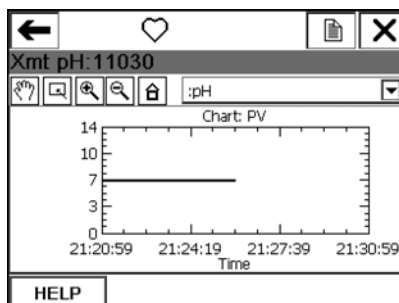



## Horizontal bar charts

A horizontal bar chart formats device data into bars from left to right and varies with time. The command bar shows the back arrow icon, HART heartbeat or fieldbus logo, LAS indicator (fieldbus devices only), ScratchPad icon, and terminate icon. The tag bar shows the device type and device tag. The chart shows the device type and device tag.

The **HELP** softkey appears if there is help associated with the particular selection. Use the buttons to pan, zoom, and reset the chart. Use the left arrow button on the 375 Field Communicator or the back arrow icon on the screen to close the chart view and return to the previous menu.

Use the drop-down menu to select the variable you want to display. Additional horizontal bars may be present if more than one variable shares the same axis as the selected variable. The selected variable from the drop-down menu appears dark while the other variables appear light grey. The values, labels, and axis displayed are determined by the device manufacturer.

The chart update rate is determined by the device manufacturer. The default chart update rate is 1 second.

Figure C-4. Horizontal bar chart example

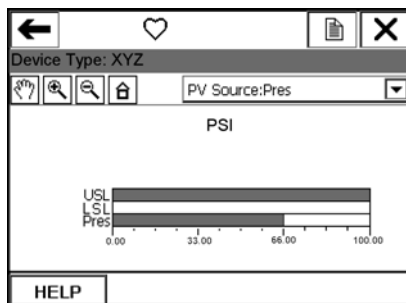

## Vertical bar charts

A vertical bar chart formats device data into bars from bottom to top and varies with time. The command bar shows the back arrow icon, HART heartbeat or fieldbus logo, LAS indicator (fieldbus devices only), ScratchPad icon, and terminate icon. The tag bar shows the device type and device tag. The chart area shows the device type and device tag.

The **HELP** softkey appears if there is help associated with the particular selection. Use the buttons to pan, zoom, and reset the chart. Use the left arrow button on the 375 Field Communicator or the back arrow icon on the screen to close the chart view and return to the previous menu.

Use the drop-down menu to select the variable you want to display. Additional vertical bars may be present if more than one variable shares the same axis as the selected variable. The selected variable from the drop-down menu appears dark while the other variables appear light grey. The values, labels, and axis displayed are determined by the device manufacturer.

The chart update rate is determined by the device manufacturer. The default chart update rate is 1 second.

Figure C-5. Vertical bar chart example

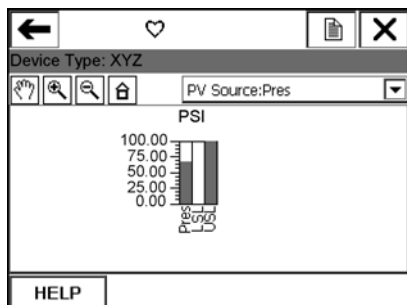

## Gauge charts

A gauge chart formats device data into a view similar to an analog car speedometer and plots device data varying with time. The command bar shows the back arrow icon, HART heartbeat or fieldbus logo, LAS indicator (fieldbus devices only), ScratchPad icon, and terminate icon. The tag bar shows the device type and device tag.

The **HELP** softkey appears if there is help associated with the particular selection. Use the buttons to pan, zoom, and reset the chart. Use the left arrow button on the 375 Field Communicator or the back arrow icon on the screen to close the chart view and return to the previous menu.

Use the drop-down menu to select the variable you want to display. Additional gauge needles may be present if more than one variable shares the same axis as the selected variable. The selected variable from the drop-down menu appears as a long, dark needle while the other variables appear as short, light grey needles. There can only be a maximum number of three variables per gauge chart. The values, labels, and axis displayed are determined by the device manufacturer.

The chart update rate is determined by the device manufacturer. The default chart update rate is 1 second.

Figure C-6. Gauge chart example

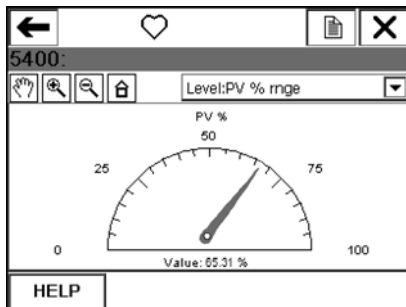

## Graphs

A graph is a snapshot line drawing of device information. The command bar shows the back arrow icon, HART heartbeat or fieldbus logo, LAS indicator (fieldbus devices only), ScratchPad icon, and terminate icon. The tag bar shows the device type and device tag.

The **HELP** softkey appears if there is help associated with the particular selection. Use the buttons to pan, zoom, and reset the graph. Use the left arrow button on the 375 Field Communicator or the back arrow icon on the screen to close the view and return to the previous menu.

Use the drop-down menu to select the plot you want to display. Additional plots may be present if more than one plot shares the same axis as the selected variable. The selected plot from the drop-down menu appears dark while the other plots appear light grey. Variables that do not share the same axis appear with a dashed line. The values, labels, and axis displayed are determined by the device manufacturer.

Figure C-7. Graph example

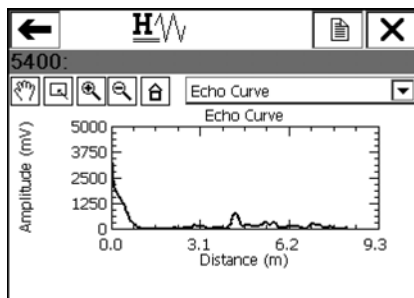

## GLOSSARY

### **Alphanumeric**

A character set that contains both letters and digits and, usually, other characters, such as punctuation marks.

### **AMS Suite: Intelligent Device Manager**

Software for remotely managing Smart field devices (offline or online) over HART or FOUNDATION fieldbus networks. You can use AMS Device Manager to monitor devices, configure devices, maintain calibration results, run diagnostic routines, and maintain historical data.

### **Burst Mode**

A communication mode in a HART transmitter to send data at regular intervals.

### **Card Reader**

A USB device that is capable of reading the 375 System Card, which is located under the battery in the 375 Field Communicator. You can use a supported card reader to transfer system software and device descriptions to a 375 from the Easy Upgrade Programming Utility. See [www.fieldcommunicator.com](http://www.fieldcommunicator.com) or the Readme file on the Resource CD for a list of supported card readers.

### **CDC**

Communication and Diagnostic Circuitry

### **Data Link Time**

Data Link Time is a network-wide time periodically distributed by the LAS to synchronize all device clocks on the bus.

## **Device Configuration**

Parameters that define the physical attributes and operating characteristics of a device. It does not include dynamic data.

## **Device Description (DD)**

A set of instructions written in the HART or FOUNDATION fieldbus Device Description Language that defines the parameters, commands, and methods that a host application uses to communicate with a HART or FOUNDATION fieldbus field device.

## **Device menu**

A menu used by some FOUNDATION fieldbus devices, depending on their device descriptions. A device menu displays the same parameters as the Block List, but the parameters in a device menu are organized by function rather than by block.

## **DDL**

Device Description Language. A specialized programming language used to write device descriptions for HART or FOUNDATION fieldbus-compatible field devices. *See also* Device Description.

## **Easy Upgrade option**

An upgrade option to the 375 Field Communicator System Card. It lets you update the 375 system software and DDs using the Easy Upgrade Programming Utility at your site. It also lets you select and enable new licenses to add new functionality in your 375. This option can be purchased from your local 375 sales representative or by using the Online Licensing feature in the Easy Upgrade Programming Utility.

## **EDDL**

Enhanced Electronic Device Description Language. Recent enhancements to the EDDL language enable device information to be displayed as images, charts, and graphs.

## **Event capture file**

An ASCII file (.rec file) that captures your keystrokes, display screens, and protocol communication messages on a 375 Field Communicator and can be played back. Event capture files can be useful in diagnosing problems. To create event capture files on a 375, you must enable the Event Capture function from the Settings menu.

## **Expansion Module (EM)**

An optional removable memory card that snaps into the Expansion Port on the side of the 375 Field Communicator. See the ordering information for availability types.

## **Field device**

Field devices may generate or receive an analog signal in addition to the HART digital communication signal.

## **Fieldbus Foundation**

The organization that develops and supports FOUNDATION fieldbus, an international, interoperable standard for communication of process automation and control information. Members include suppliers and end users of process control and manufacturing automation products. Support for the standard includes education, interoperability and conformance testing, testing tools, and development software.

## **FOUNDATION fieldbus**

A specific fieldbus technology developed and supported by Emerson Process Management and the other members of the independent Fieldbus Foundation. FOUNDATION fieldbus technology uses device descriptions and function blocks to enable intelligent field devices to execute control functions traditionally performed by a distributed control system.

## **Graphics**

A feature that enables the 375 Field Communicator to display device information as images, charts, and graphs. The Graphics feature utilizes enhanced Electronic Device Description Language, EDDL. To view the graphical representations, you need a device with enhanced EDDL, a 375 Field Communicator with a Graphics license, and the 375 system software version 2.0 or higher. If the 375 Field Communicator does not have a Graphics license, enhanced DDs can still be used. However, the graphical representations will not be displayed.

## **HART device**

A device that communicates information using the HART protocol.

## **HART loop**

A communication network in which the master and slave device are HART-smart or HART-compatible.

## **HART protocol**

Highway Addressable Remote Transducer communication protocol. An industry-standard protocol for digitally enhanced 4-20 mA communication with Smart field devices.

## **HART tag**

An 8-character field used to identify a device. A 32-character long tag is also possible with HART Universal revision 6 devices. This field is stored in the HART device and can be modified.

## **Instantiation**

Some FOUNDATION fieldbus devices support instantiation of function or transducer blocks in the device. This means the device allows a command to be sent to it that will create or instantiate additional function or transducer blocks in the device. After being instantiated, these blocks operate like any other block in the device. The 375 Field Communicator supports the commands to instantiate and to delete function and transducer blocks in a fieldbus device.

## **Internal Flash**

Non-volatile memory that stores the operating system, application software, internal device configurations, event captures, fieldbus statistics, and user generated text files.

## **Intrinsic Safety (IS)**

Circuits that are designed to limit the amount of energy consumed or provided to field devices to levels below those that are required to ignite specific types of hazardous materials under fault and no fault conditions.

Also a method of providing safe operation of electronic process-control devices in hazardous areas, such as flammable environments. IS systems keep the available electrical energy in the system low enough that ignition of the hazardous atmosphere cannot occur.



## **Intrinsic Safety barrier**

A physical entity that limits the current and voltage into a hazardous area in order to satisfy Intrinsic Safety requirements.

## **IrDA**

Infrared Data Association, a non-profit trade association that establishes standards for infrared communications between devices such as personal computers, printers, and handheld devices.

## **Link Active Scheduler (LAS)**

The bus arbiter for the segment. The LAS recognizes and adds new devices to the link, removes non-responsive devices from the link, and distributes Data Link (DL) and Link Scheduling (LS) time on the link.

## **Link Master**

A Link Master device controls when devices access the fieldbus and executes the link schedule, which synchronizes communications with function block execution on the fieldbus. The H1 card or any field device that supports Link Master functionality can function as a Link Master device. Only one Link Master device can be active at a time on the fieldbus segment. This device is called the LAS.

## **Link Scheduling time**

Link Scheduling time is a link-specific time represented as an offset from Data Link Time. It is used to indicate when the LAS on each link begins and repeats its schedule. System management uses it to synchronize function block execution with the data transfers scheduled by the LAS.

## **Lithium Ion Power Module**

A Lithium Ion (Li-Ion) battery used to power the 375 Field Communicator. The Power Module has a green, 6-pin power supply/charger connector. See Figure 2-3 on page 2-11 for the location of this connector. The Power Module must be charged by the power supply/charger with the green connector.

## **NiMH Adapter Cable**

A cable used to recharge a NiMH Battery Pack with the power supply/charger. The colors on the adapter cable connectors match the corresponding connectors on the NiMH Battery Pack and the power supply/charger.

## **NiMH Battery Pack**

A Nickel-Metal Hydride (NiMH) battery used to power the 375 Field Communicator. It has a black, 4-pin power supply/charger connector. See Figure 2-3 on page 2-11 for the location of this connector.

## **Online Licensing**

A feature in the Easy Upgrade Programming Utility to select and download new licenses that enable additional functionality in the 375 Field Communicator. You can order and download licenses for the FOUNDATION Fieldbus Application, Easy Upgrade option, and the Graphics option. See the Easy Upgrade Programming Utility online Help for more information.

## **Personal Computer (PC)**

Synonymous with microcomputer, a computer that serves one user in the office or the home.

## **Polling**

A method of sequentially interrogating a network to determine which devices are present.

## **Process variable (PV)**

A process parameter that is being measured or controlled (for example, level, flow, temperature, mass, or density).

## **Segment (Fieldbus only)**

The section of a fieldbus that is terminated in its characteristic impedance. Segments are linked by repeaters to form a complete Fieldbus.

## **Shout/deaf mode**

A communication mode in the 375 Field Communicator where the amplitude of the 375 signal is increased to help it communicate with devices on a noisy loop. The 375 Field Communicator determines when to enter this mode.

## **Stand-By**

A power option that turns off the screen display and parts of the 375 Field Communicator. Use this feature to save battery life or to reduce the boot-up time. The green, slowly flashing multifunction LED indicates the 375 Field Communicator is in stand-by mode.

## **System Card**

An internal Secure Digital Card with non-volatile Flash memory. A copy of installable 375 Field Communicator application software exists on every System Card. The System Card also stores all HART and FOUNDATION fieldbus device descriptions.

## **System Card Serial Number (S/N)**

The serial number assigned by the manufacturer to a Secure Digital (SD) card. The System Card Serial Number uniquely identifies a 375 Field Communicator System Card.

## **User Configuration**

A configuration that is created offline or that is transferred to a 375 Field Communicator from another program. Editing a device configuration within the 375 Field Communicator will change it to a user configuration.

## **User data file**

A text (.TXT) file created by a user either on a PC or with ScratchPad on the 375 Field Communicator. User data files can be transferred between the Easy Upgrade Programming Utility and a 375.

## **WirelessHART device**

A digital HART device that meets the WirelessHART standard and has been enhanced with wireless capability to function within a Wireless network.

## **WirelessHART adapter**

A HART device that meets the WirelessHART standard and attaches to a wired HART device to let it join a Wireless network and communicate with the gateway.



## INDEX

### **Symbols**

.rec files 2-20, G-ii

.txt files 2-24, G-vii

### **Numerics**

375 Main Menu 2-15

### **A**

About 375 2-16

Alphanumeric keypad 2-13, A-2

AMS Device Manager 2-22, 2-23, G-i

Analog output 3-11

Approval drawings B-7

Asterisk 3-11, 4-15

ATEX B-3

Auto-off timer

    Disabled 2-16, 2-19, 2-22, 2-24

    Enable 2-18

### **B**

Backlight

    Intensity 2-19

    Key 2-10, 2-13

    Setting 2-16, 2-19

    Timer 2-16, 2-19

Basic Setup menu 3-13

Battery

    Charge 2-5

    Conserve power 2-10, 2-18

    Discharge 2-4, 2-19

    Guidelines 2-4

    Install 2-8

    Lights 2-5

    Location 2-11

    Reduced life 2-13, 2-19

    Remove 2-9

    Types 2-4

Bench wiring 4-7

Blocks

    Delete 4-19

    Device 4-14

    Instantiate 4-19

    List 4-10

Brightness, see Backlight

    2-16

Burst Mode 3-2, G-i

### **C**

Canadian Standards Association B-2

Card Reader

    Definition G-i

    Overview 2-21

    Warning 2-2

CDC G-i

CE Compliance B-1

Certifications

    European B-3

    International B-2

    North American B-2

Changing

    Damping 3-13

    Device parameters 3-12, 4-1

    I/O Block Schedule 4-18

    Ignored status messages 3-19

    Menu Title 3-19

    Modes 4-13

    Polling 3-17, 4-21

    Range values 3-13

    Slot Time 4-21

    Tag 3-13, 4-17

Charts C-5

    Gauge C-9

    Horizontal bar C-7

    Response time C-5

- Strip/Scope/Sweep C-5
- Vertical Bar C-8
- Clock 2-17
- Communication and Diagnostic Circuitry 2-16, G-i
- Configuration
  - Copying 3-6
  - Creating new 3-3
  - Device G-ii
  - HART offline 3-3, 3-5
  - Opening 3-4
  - Partial 3-3
  - Saving online 3-12
  - Sending 3-6
  - User 3-3, G-vii
- Configure
  - Fieldbus Application 4-21
  - HART Application 3-17
- Connecting
  - 250-ohm resistor 3-10
  - Fieldbus device 4-7
  - Fieldbus segment 4-5, 4-8
  - HART device 3-10
  - HART loop 3-8
  - Load resistor 3-10
- Conserve battery power 2-10, 2-18
- Contrast 2-17
- Copying
  - HART configurations offline 3-6
  - Text 2-25
- Cutting text 2-25
- D**
- D/A trim 3-13
- Damping 3-13, 3-15
- Data Link Time G-i
- Date/Time 2-17
- DDL G-ii
- Deleting
  - Document 2-26
  - Instantiated Blocks 4-19
- DeltaV System Polling checkbox 4-21
- Detail 4-16
- Detailed Setup 3-13
- Device
  - Address 4-17
  - Blocks 4-14

- Configuration 2-27, G-ii
- ID 4-17
- Revision 4-17
- Setup 3-12
- Status 4-15
- Tag 3-13, 4-17
- Test 3-12, 4-3
- Device Description
  - Add 2-23
  - Available 3-20, 4-22
  - Definition G-ii
  - Icons 3-20, 4-22
  - Storage 2-27
- Diagnostics
  - And Service 3-12
  - Fieldbus 4-23
  - HART 3-22
- Discharge the battery 2-19
- Disconnecting
  - Fieldbus device 4-24
  - HART device 3-22
- Display, see Touch screen
- Disposal 2-29
- Document
  - Deleting 2-26
  - Opening 2-26
  - ScratchPad 2-25

**E**

- Easy Upgrade
  - Option G-ii
  - Programming Utility 2-17, 2-20, 2-21, 2-22, 3-14, 4-20
- EDDL 3-14, 4-20, G-ii
- Edit HART configurations offline 3-5
- Electro Magnetic Compatibility B-1, B-2
- Enclosure rating A-5
- Enter key
  - Location 2-11
  - Use 2-12
- Entering text 2-25
- Error messages 5-6
- European
  - Certifications B-3
  - Directive information B-1
- Event capture 2-20, G-ii, G-iv
- Exiting ScratchPad 2-27

Expansion Module 2-27, 3-20, A-1, G-iii

## F

Factory Mutual B-2

Fast key 3-2

Features 3-2

375 Basic 2-11

Fieldbus Application 4-2

HART Application 3-2

Field device G-iii

Fieldbus 2-10

Bench wiring 4-7

Connecting the segment 4-5

Diagnostics 4-23

Field wiring 4-8

Foundation G-iii

Functionality 2-17, 4-1, 4-2

Online 4-5

Starting 4-4

Utility menu 4-21

Fieldbus Terminals 4-6

File

Management 2-27

Transfer 2-23

Filter

Sort 3-4

Tag 3-4

FILTR button 3-4

Flash, see Internal Flash 2-27

Foundation fieldbus

Application 2-15, 2-17, 4-1

Definition G-iii

Function

Blocks 4-14

Key 2-13

## G

Gauge chart C-9

Graphics G-iii

Buttons C-3

Controls C-3

Enhanced DDs 3-14, 4-20

For fieldbus devices 4-20

For HART devices 3-14

License 3-14, 4-20, C-1, G-iii

Options C-4

Overview C-1

Graphs C-10

## H

HART 2-10

Application 2-15

Device G-iii

Diagnostics 3-22

Functionality 3-1

Icon 3-2

Long tag 3-19

Loop 3-9, G-iv

Connecting 3-8

Troubleshooting 5-2

Main menu 3-2

Offline menu 3-3

Polling options 3-17

Protocol G-iv

Short tag 3-19

Simulation 3-21

Starting application 3-2

Tag G-iv

Terminal access door 3-9

Terminals 3-8

Utility menu 3-17

Wiring 3-9

Hazardous Locations Certifications

CSA B-2

FM B-2

Hazardous Substances 2-29

HOME 3-11

Horizontal bar chart C-7

Hot Key

Cleanup 3-20

Executing 3-16

Removing 3-16

Setting Up 3-15

## I

I/O block schedule 4-18

IECEX B-2

Ignored status messages 3-19

Images C-4

Install

Battery 2-4

DDs 2-23

System Card 2-8

System Software 2-23

Instantiate blocks 4-19, G-iv  
Internal Flash 3-20, A-1, G-iv  
International Certifications B-2  
Interoperability 4-3  
Intrinsic Safety 2-3, G-iv, G-v  
IrDA

- Adapter 2-21
- Association G-v
- Interface 2-22

## K

Key  
Alphanumeric keypad 2-13, A-2  
Backlight 2-13  
Enter 2-12  
Fast key sequences 3-2  
Function 2-13  
Hot Key Options 3-15  
Keyboard, see Soft Input Panel 2-14  
Navigation 2-12  
On/Off 2-9, 2-10, 2-12, 2-22, 2-24  
Tab 2-12  
Keypad, See also Alphanumeric keypad  
KL option 2-3, A-5

## L

Label  
Drawings B-4  
Intrinsic Safety B-1  
Main unit B-1  
4-2  
LED 2-5, 2-14  
License 2-17, 2-23  
Li-Ion Power Module  
Definition G-v  
Operating time A-4  
Specifications A-4  
Storage temperature limits A-4  
Transporting 2-4  
Usage guidelines 2-7  
Link Active Scheduler 4-2, 4-3, 4-9, G-v  
Link Master devices 4-2, G-v  
Link Scheduling time G-v  
Listen for PC 2-12, 2-22  
Live Device List 4-9  
Load resistor 3-10  
Long tag 3-19

Loop  
HART 3-9, G-iv  
Terminals 3-8  
Test 3-13  
Troubleshooting 5-2  
Lower range value 3-11

## M

Main unit label B-1  
Maintenance 2-28  
Managing files 2-27  
Manufacturing locations B-1  
Maximize Power Savings 2-18  
Memory  
Specifications A-1  
Types 2-27  
View free space 2-18  
Menu  
375 Main 2-15  
Block 4-14  
Fieldbus Diagnostics 4-23  
Fieldbus Main 4-4, 4-21, 4-22  
Fieldbus Online 4-5, 4-20  
Fieldbus Utility 4-4, 4-21, 4-22  
HART Diagnostics 3-22  
HART Offline 3-3, 3-4  
HART Online 3-11, 3-14  
HART Utility 3-16, 3-17, 3-19, 3-20, 3-21  
Hot Key 3-15  
Settings 2-15  
Title 3-19  
Messages  
Error 5-6  
Ignored Status 3-1, 3-19  
Safety 2-1, 3-1, 4-1  
Status 5-6  
Methods 4-16  
Microprocessor A-1  
Modes 4-11  
Actual 4-13  
Block 4-14  
Burst 3-2, G-i  
Change 4-13  
Listen for PC 2-22  
MAN 4-14  
Out of Service 4-14



- Parameters 4-3, 4-12
- Shout/deaf 3-2, G-vi
- Target 4-13
- Types 4-11
- Multifunction LED
  - Location 2-11
  - Meanings 2-14
- N**
- Navigation keys 2-12
- Network Management 4-18
- NiMH Battery Pack
  - Definition G-vi
  - Operating time A-4
  - Specifications A-4
  - Usage guidelines 2-7
- North American Certifications B-2
- O**
- Offline 3-3
- On/Off key
  - Disabled 2-22, 2-24
  - Location 2-11
  - Overview 2-12
  - Shutdown 2-10
  - Start up 2-9
- Online 3-8
  - Fieldbus menu 4-5, 4-9
  - HART menu 3-11
  - Licensing 2-23, G-vi
- Opening
  - Document 2-25, 2-26
  - Saved configurations 3-4
- Operating system 2-16
- Ordering information A-5
- Output trim 3-13
- P**
- Parameters
  - Changing and sending data 4-15
  - Displaying blocks 4-15
  - Functionality 4-14
  - Modes 4-12
  - Modified 4-15
- Pasting text 2-25
- Personal Computer A-2, G-vi
- Physical device tag 4-17
- Physical specifications A-2
- Polarity 4-5
- Polling 3-17, 4-21, G-vi
- Power Management 2-18
  - Key 2-12
  - Timers 2-18
- Power Status 2-18
- Power supply/charger
  - Charge battery 2-5
  - Connector location 2-11
  - Guidelines 2-4
  - Light 2-5
  - Specifications A-3
  - Voltage A-3
- Primary variable 3-11
- Process variables 3-12, G-vi
- Processor specifications A-1
- Product Precautions 2-1
- Protocol
  - Fieldbus G-iii
  - HART G-iv
- R**
- RAM 2-27, A-1
- Range values 3-13
- Re-Flash 2-1, 2-16
- Re-Image 2-16
- Repair 2-28
- Resistance
  - Troubleshooting 5-2
- Retrain The Battery 2-4, 2-19
- Review menu 3-13
- RoHS 2-29
- S**
- Safety messages 2-1, 3-1, 4-1
- Saving
  - Online configuration 3-12
  - Text 2-26
- Scaled D/A trim 3-13
- Schedule I/O Block 4-18
- Scope chart C-6
- ScratchPad
  - Application 2-12, 2-24
  - Copying text 2-25
  - Cutting text 2-25
  - Entering text 2-25

- Exiting 2-27
  - New 2-24
  - Opening 2-25, 2-26
  - Pasting text 2-25
  - Saving text 2-26
  - Selecting text 2-25
  - Screen. See Touch Screen 2-19
  - Segment G-vi
  - Self test 2-28
  - Sending HART configurations 3-6
  - Sensor setup 3-13
  - Sensor trim 3-13
  - Settings
    - About 375 2-16
    - Backlight 2-16
    - Clock 2-17
    - Contrast 2-17
    - Event capture 2-20
    - License 2-17
    - Memory 2-18
    - Menu 2-15
    - Power Status 2-18
    - Retrain the Battery 2-19
    - Touch screen 2-19
  - Shock A-2
  - Short tag 3-19
  - Shout/deaf mode 3-2, G-vi
  - Shut-down timer. See Auto-off timer
  - Shutting down 2-9, 2-10
  - Simulation 3-21
  - Soft Input Panel (SIP) 2-14
  - Sort 3-4
  - Specifications
    - Alphanumeric keypad A-2
    - Communication A-2
    - Enclosure rating A-5
    - Expansion Module A-1
    - Internal Flash A-1
    - Memory A-1
    - Microprocessor A-1
    - Personal Computer A-2
    - Physical A-2
    - Power supply/charger A-3
    - Processor A-1
    - RAM A-1
    - Shock A-2
    - Storage A-4
    - System Card A-1
    - Usage A-4
    - Weight A-2
  - ST\_REV 4-3
  - Stand-By
    - Definition G-vii
    - Enter/Leave 2-10, 2-12
    - Mode 2-14
    - Timer 2-10, 2-16, 2-18, 2-19, 2-22, 2-24
  - Starting up 2-15
  - Status
    - Device 4-15
    - Ignore messages 3-1
    - Messages 5-6
    - Number of Ignored 3-19
  - Storage A-4
    - Cleanup 3-20
    - Device configurations 2-27
    - Files 2-27
    - Internal Flash 2-27
    - Types 2-27
  - Strip chart C-5
  - Stylus 2-14
  - Sweep chart C-6
  - System Card A-1, G-vii
    - Corrupt 2-2
    - Install 2-8
    - Location 2-11
    - Remove 2-9
    - Serial Number 2-17, G-vii
  - System software version 2-1, 2-16
- T**
- Tab key 2-12
  - Tag
    - access 3-13
    - alphanumeric 3-13
    - Device 3-15, 4-16, 4-17, C-6, C-7, C-8
    - Filter 3-4
    - HART G-iv
    - Polling 3-18
  - Technical Support 5-10
  - Terminals 2-11, 3-8, 4-6, A-2
  - Test
    - Device 3-12, 4-3
    - Loop 3-13

Self 2-28  
Text. See ScratchPad 2-25  
Time/Date 2-17  
Timers  
  Auto-off 2-16, 2-18, 2-19, 2-22, 2-24  
  Backlight 2-16, 2-19  
  Stand-By 2-10, 2-16, 2-22, 2-24  
Touch screen  
  Alignment 2-19  
  Layout C-2  
  Specifications A-2  
  Using 2-14  
Transferring files 2-23  
Trim  
  D/A 3-13  
  Scaled D/A 3-13  
  Sensor 3-13  
Troubleshooting 5-1

## U

Unit name 2-17  
Untested Device Description 4-3  
Upper range value 3-11  
User Configuration 3-3, G-vii  
User data file G-vii  
Utility menu  
  Fieldbus 4-4, 4-21, 4-22  
  HART 3-2, 3-16, 3-17, 3-19, 3-20

## V

V(FUN) 4-21  
V(NUN) 4-21  
Vertical Bar chart C-8  
Voltage  
  HART 3-22  
  Insufficient 4-4  
  Measurements 3-1  
  Power supply/charger A-3  
  Troubleshooting 5-3

## W

Waste Disposal 2-29  
Web site 4-3  
WEEE 2-29  
Weight A-2  
WirelessHART adapter G-vii  
WirelessHART device G-vii

## Wiring

Fieldbus 4-7, 4-8  
HART 3-9  
Troubleshooting 5-4

## X

XPAND button 3-5



## Emerson Process Management

Asset Optimization Division  
12001 Technology Drive  
Eden Prairie, MN 55344 USA

Emerson Process Management  
00375-0047-0001, rev F



©2009, Emerson Process Management.

The contents of this publication are presented for informational purposes only, and while every effort has been made to ensure their accuracy, they are not to be construed as warranties or guarantees, express or implied, regarding the products or services described herein or their use or applicability. All sales are governed by our terms and conditions, which are available on request. We reserve the right to modify or improve the designs or specifications of our products at any time without notice.

All rights reserved. The Emerson logo is a trademark and service mark of Emerson Electric Co. All other marks are the property of their respective owners.

Printed in USA/2-2009

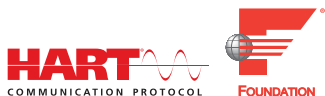

[www.fieldcommunicator.com](http://www.fieldcommunicator.com)



**EMERSON**  
Process Management