

# Keystone OM13 - EPI2

3-Wires Module



*This page intentionally left blank*

# Table of Contents

## **Section 1: Optional Module 13: 3-Wires Module**

1.1	OM13 Module Functionality .....	1
1.2	Manufacturer .....	2

## **Section 2: Installation**

2.1	Assembling Procedure for Models 63-125 Nm Old Version (US or Non-US Market) .....	4
2.2	Assembling Procedure for Models 250-500-1000-2000 Nm Old Version (US or Non-US Market) .....	9
2.3	Assembling Procedure for Models 63-125 Nm New Version (US or Non-US Market) .....	14
2.4	Assembling Procedure for Models 250-500-1000-2000 Nm New Version (US or Non-US Market) .....	20

## **Section 3: OM13 Module Setting and Configuration**

	OM13 Module Setting and Configuraton .....	25
--	--	----

## **Section 4: OM13 Kit**

	OM13 Kit .....	26
--	----------------	----

## **Section 5: OM13 Wiring Diagram**

	OM13 Wiring Diagram .....	30
--	---------------------------	----

*This page intentionally left blank*



---

**NOTE:**

Before installation, these instructions must be fully read and understood.

---

# Section 1: Optional Module 13: 3-Wires Module

## 1.1 OM13 Module Functionality

The OM13 3-wires module is supplied as an option to the Keystone EPI2 actuators. It is possible to receive the actuator already equipped with the OM13, ordering it with the basic feature. Alternatively, it is possible to order the OM13 as a separate kit and install it in the basic actuator in the factory or in the field. The OM13 is an optional module suitable to accomplish the following EPI2 actuator additional functionality:

- 120/240 V AC 1-phase, 50/60 Hz, 3-wire control for open/close operations, without additional power supply.

---

**NOTE:**

For decommissioning instructions, please refer to the relevant section in the EPI2 VCIOM-15516-EN.

---

---

**NOTE:**

The OM13 command has to be provided by two separate switches for open and for close with a delay of at least one second between the two commands, when reversing the operation from open to close or vice versa.

---

** WARNING**

EPI2 actuator must be electrically isolated before any disassembling or reassembling operations. Before any disassembling or reassembling operations, please follow in detail the relevant paragraph of the basic installation and operating manual (latest revision available).

---

** WARNING**

The electronic parts of the EPI2 actuators and all option modules can be damaged by a discharge of static electricity. Before you start, touch a grounded metal surface to discharge any static electricity.

---

**⚠ WARNING**

It is assumed that the installation, configuration, commissioning, maintenance and repair works are carried out by qualified personnel and checked by responsible specialists.

---

**⚠ WARNING**

Repair work, other than operations outlined in this manual, is strictly reserved to qualified Emerson personnel or to personnel authorized by the company itself.

---

## 1.2 Manufacturer

Manufacturer with respect to Machinery Directive 98/37: as specified on the EPI2 label.

## Section 2: Installation

To assemble the OM13 into the EPI2 actuator, proceed as follows:

- Ensure that all the parts received with the OM13 are available as described in Section 4.
- Using Section 4, select only mechanical parts (screws and spacers) depending on actuator models.
- Gather the right tools for the assembly and for setting the actuator controls.
- With an Allen wrench of 5 mm, unscrew the cover screws as shown in Figure 1.
- Remove the actuator cover as shown in Figure 2.

---

**Figure 1**



---

**Figure 2**



---

Follow one of the following assembling procedures depending on actuator model.

## 2.1 Assembling Procedure for Models 63-125 Nm Old Version (US or Non-US Market)

- Verify that you received the correct OM13 3-wire module as shown in Figure 3.
- Remove the following as indicated in Figure 4:
  - 3-pins connector cable
  - 4-pins connector cable
  - 8-pins connector cable

Figure 3

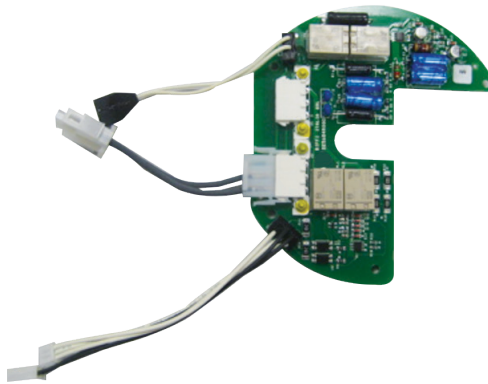
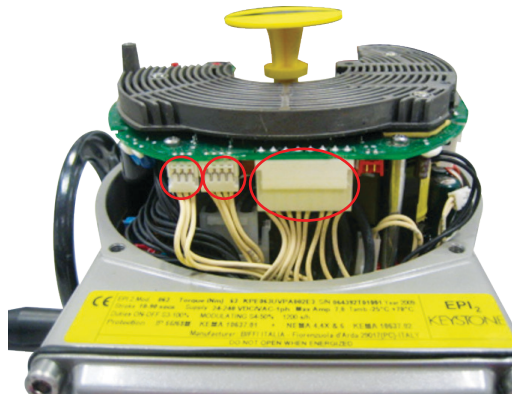

Figure 4



- Remove the 3-wire power connector cable from the power card as indicated in Figure 5.
- Remove the 3 screws (3 pcs M3x10) from the logic board and screw the 3 metal spacers as shown in Figure 6.

Figure 5



Figure 6

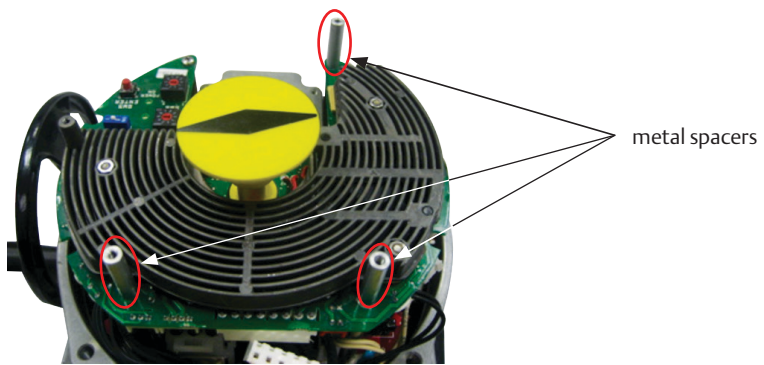

- Place the OM13 card onto the spacers and tighten the 4 screws as shown in Figure 7.
- Remove the 2-pins connector cable from J1 on the power card as shown in Figure 8.

Figure 7

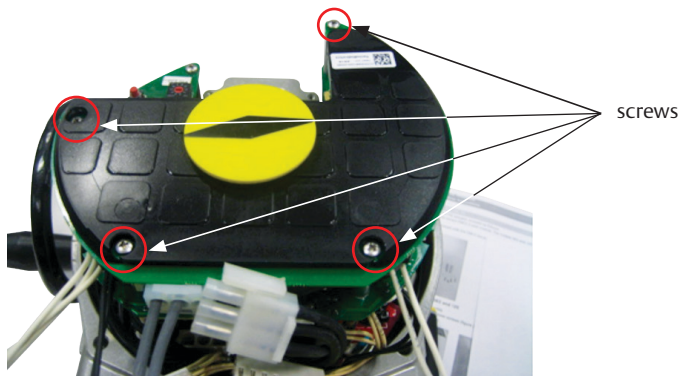
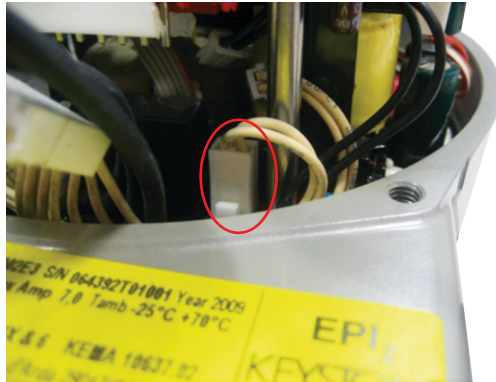

Figure 8



- Connect the 2-wire power connector cable of the OM13 card to the power card as shown in Figure 9.
- Connect the 3-wire power connector cable of the terminal board to the OM13 card as shown in Figure 10.

Figure 9

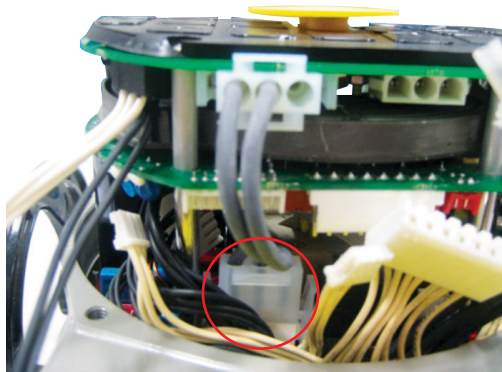
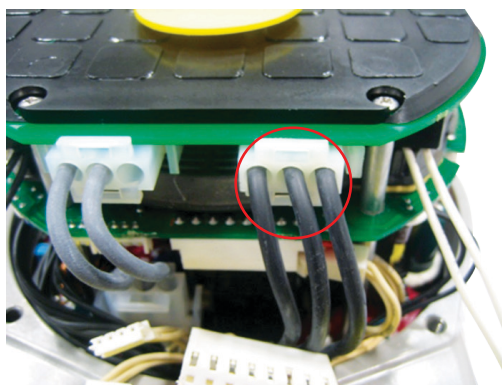
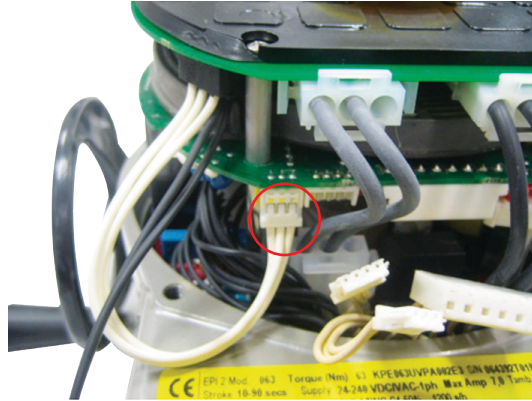

Figure 10



- Connect the 3-pins connector cable of the OM13 module to the logic card as shown in Figure 11.
- Reconnect the 8-pins connector cable and 4-pins connector cable as shown in Figure 12.

---

**Figure 11**

---

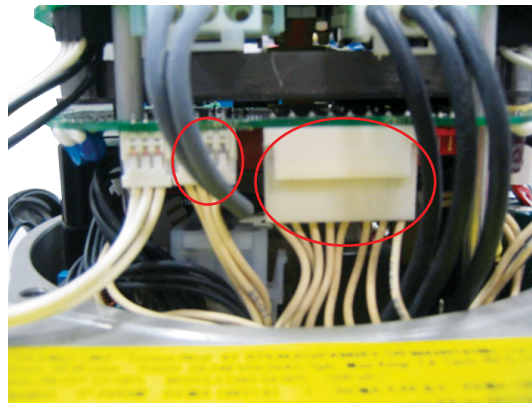
**Figure 12**

- Connect the 2-pins black connector from OM13 module to the 2-pins connector previously removed as shown in Figure 13.
- Connect the 2-pins connector black cable from the OM13 module to the power card as shown in Figure 14.



Figure 13

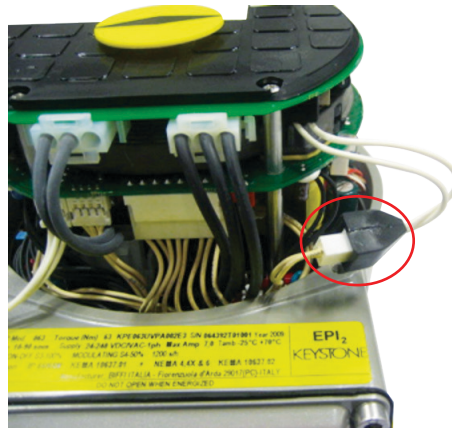
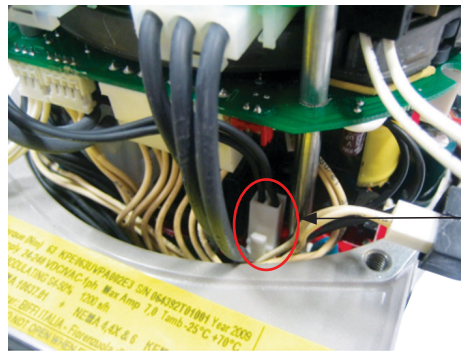

Figure 14



black cable



## 2.2 Assembling Procedure for Models 250-500-1000-2000 Nm Old Version (US or Non-US Market)

- Verify that you received the correct OM13 3-wire module as shown in Figure 15.
- Remove the following as indicated in Figure 16:
  - 3-pins connector cable
  - 4-pins connector cable
  - 8-pins connector cable

Figure 15

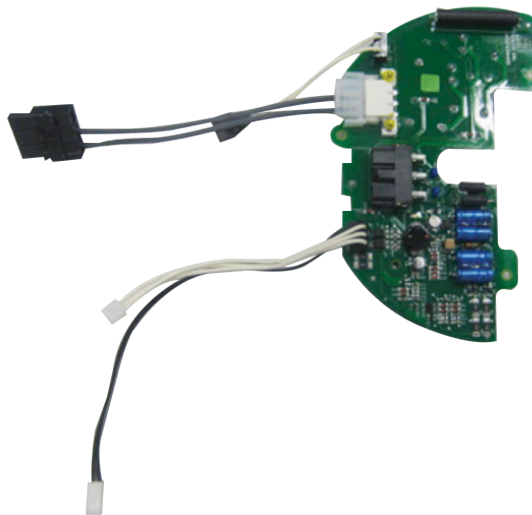
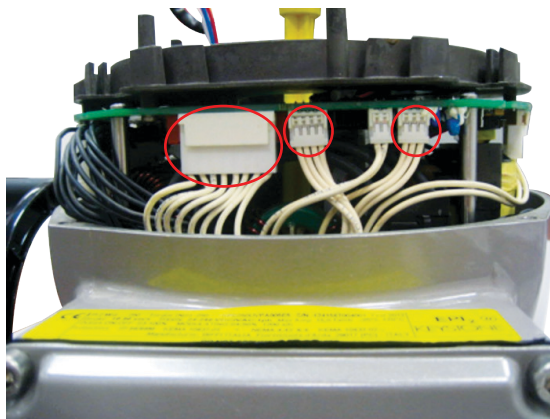
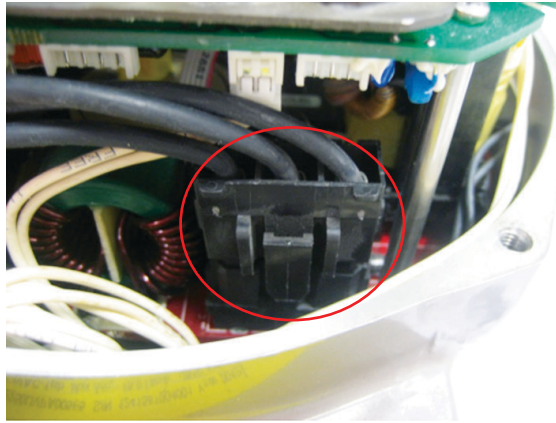

Figure 16



- Remove the 3-wire power connector cable from the power card as shown in Figure 17.
- Remove the 2-pins connector cable from J1A on the logic card as shown in Figure 18.

---

**Figure 17**

---

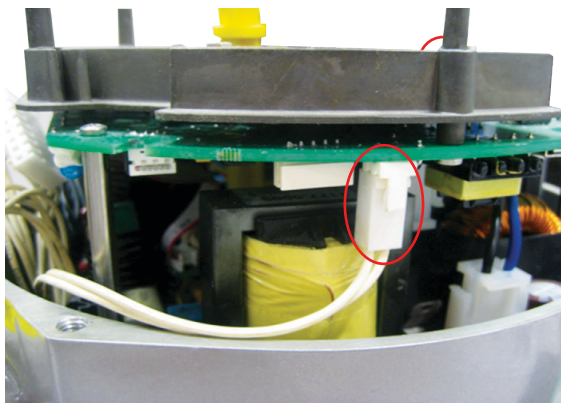
**Figure 18**

- 
- Connect the 3-wire power connector cable from the terminal board to the OM13 as shown in Figure 19.
  - Place the OM13 card onto the heatsink spacers (if necessary use 3.2 mm height plastic spacers) and tighten the 4 screws as shown in Figure 20.

Figure 19

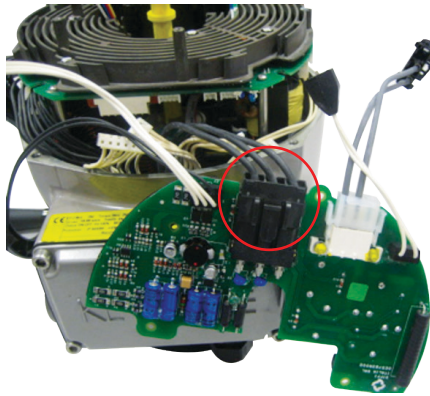
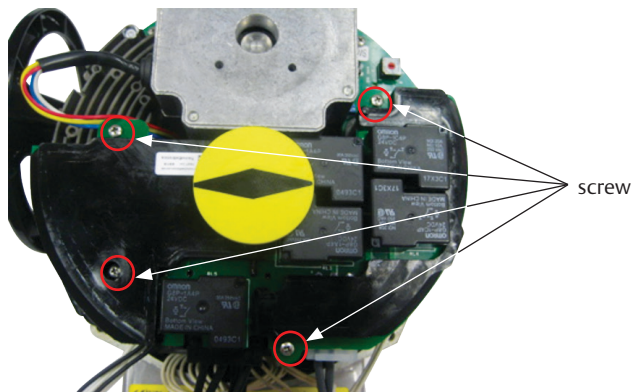
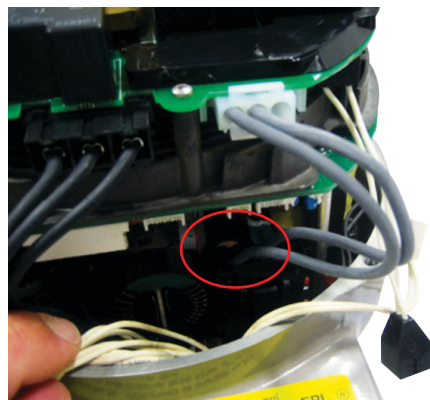

Figure 20



- Connect the 2-wire power connector cable of the OM13 card to the power card as shown in Figure 21.
- Reconnect the 8-pins connector cable and the 4-pins connector cable as shown in Figure 22.

Figure 21

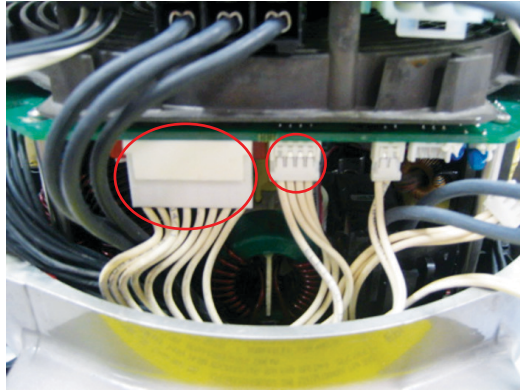

---

**Figure 22**

- 
- Connect the 3-pins connector cable of the OM13 module to the logic card as shown in Figure 23.
  - Connect the 2-pins black connector from OM13 module to the 2-pins connector previously removed as shown in Figure 24.

---

**Figure 23**

Figure 24



- Connect the 2-pins connector black cable from the OM13 module to connector J1A on the logic card as seen in Figure 25.

Figure 25

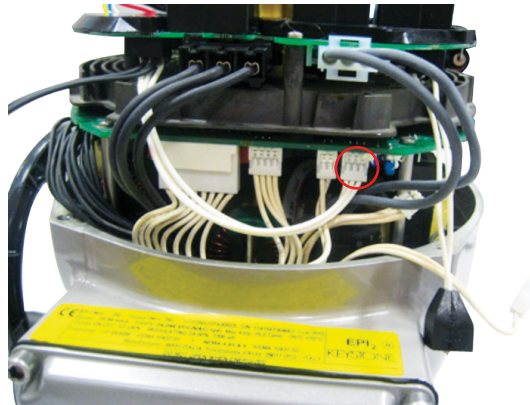
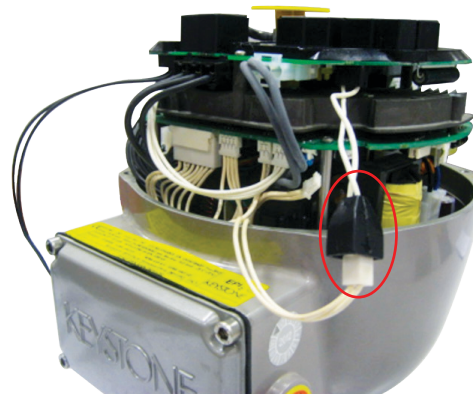
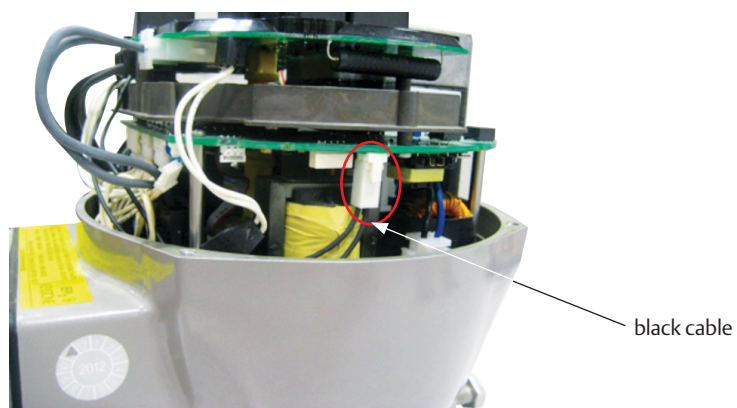

## 2.3 Assembling Procedures for Models 63-125 Nm New Version (US or Non-US Market)

- Verify that you received the correct OM13 3-wire module as shown in Figure 26.
- Remove the following as indicated in Figure 27:
  - 3-pins connector cable
  - 4-pins connector white cable
  - 4-pins connector black cable
  - 8-pins connector cable

Figure 26

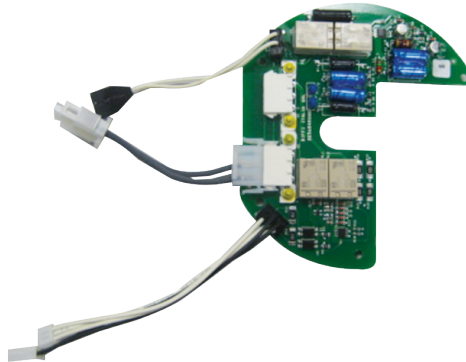
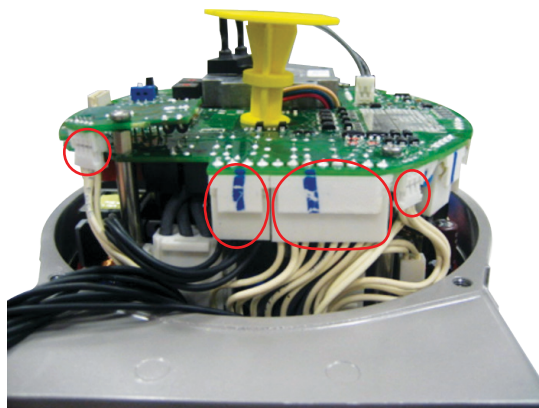

Figure 27





- Remove the 3-wire power connector cable from the power card as indicated in Figure 28.
- Remove the 2-pins cable from connector on the power card as indicated in Figure 29.
- Remove the 3 screws from the logic board; screw the 3 metal spacers and insert the plastic spacer as indicated in Figure 30.

---

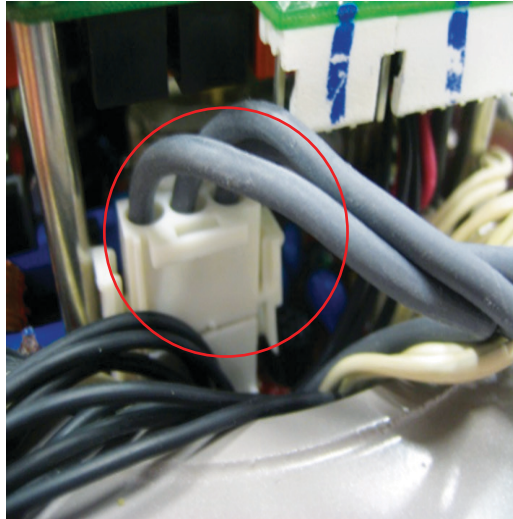
**Figure 28**

---

**Figure 29**

Figure 30



- Place the OM13 card onto the spacer and tighten the 3 screws as indicated in Figure 31.
- Connect the 2-wire power connector cable of the OM13 card to the power card as indicated in Figure 32.

Figure 31

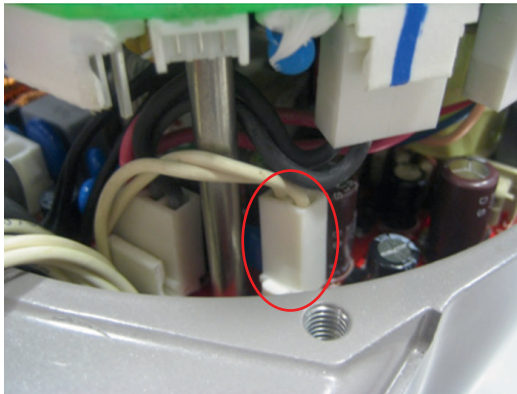
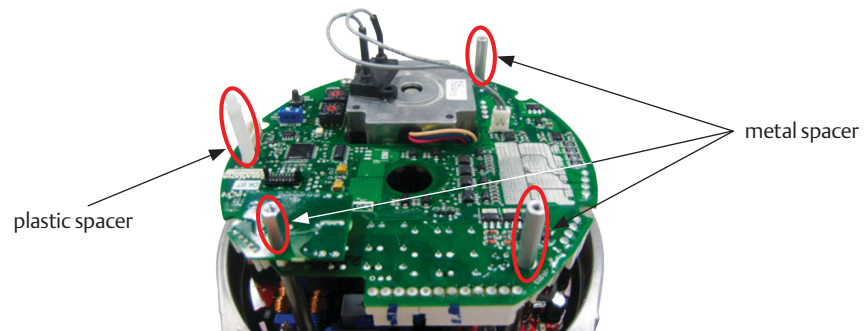
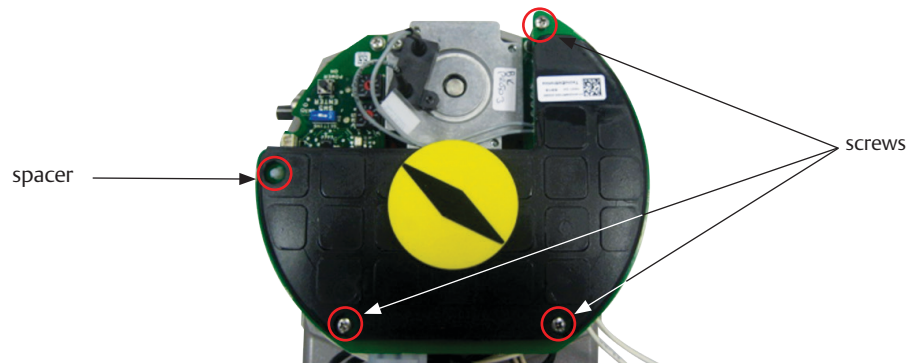
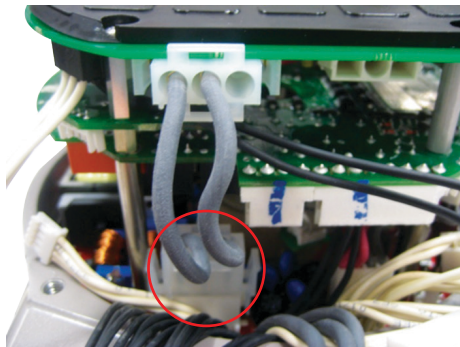

Figure 32





- Reconnect the 8-pins connector cable and 4-pins connector black cable as seen in Figure 33.
- Connect the 3-wire power connector cable of the terminal board to the OM13 card as seen in Figure 34.

---

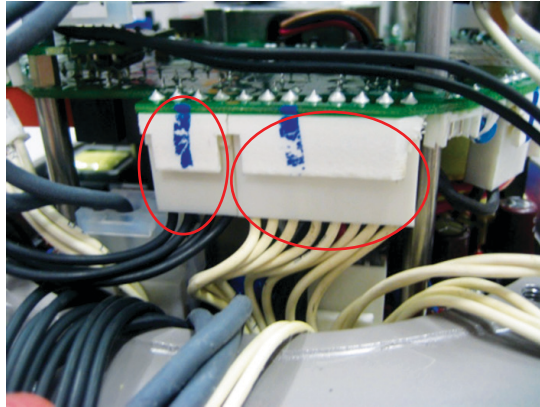
**Figure 33**

---

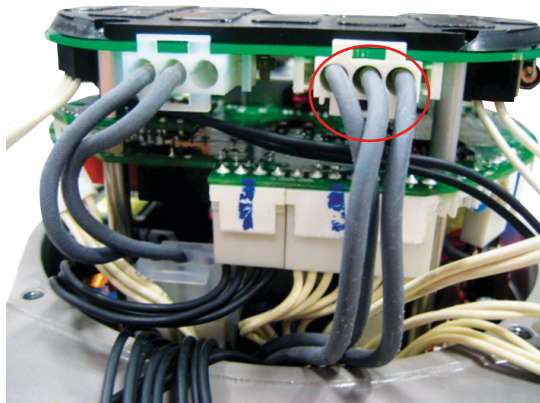
**Figure 34**

- Reconnect the 4-pins connector cable as seen in Figure 35.
- Connect the 3-pins connector cable of the OM13 module to the logic card as seen in Figure 36.

Figure 35

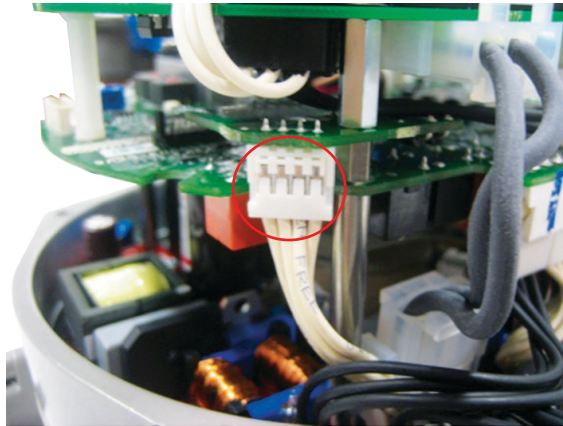
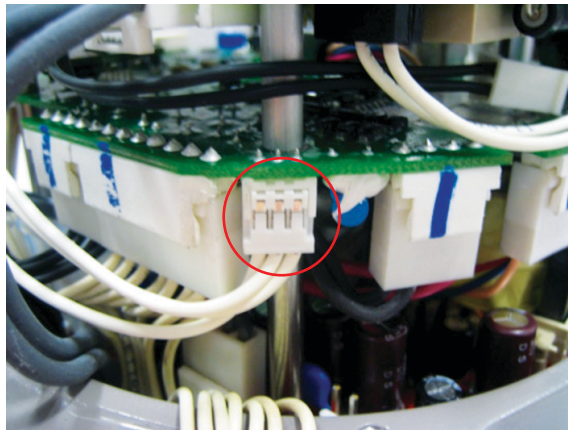

Figure 36



- Connect the 2-pins connector black cable from the OM13 module to the power card as seen in Figure 37.
- Connect the 2-pins black connector from OM13 module to the 2-pins connector previously removed as seen in Figure 38.

Figure 37

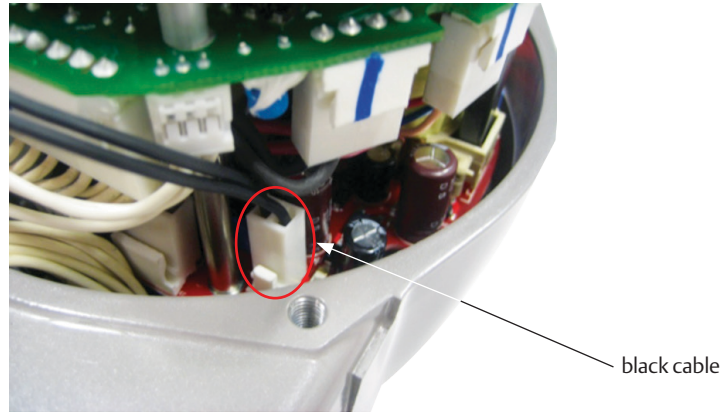
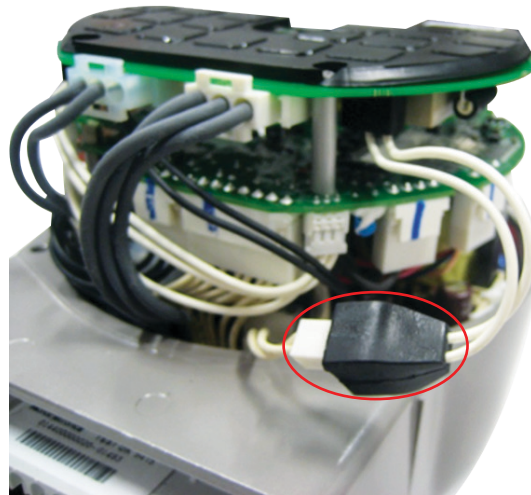

Figure 38



## 2.4 Assembling Procedure for Models 250-500-1000-2000 Nm New Version (US or Non-US Market)

- Verify that you received the correct OM13 3-wire module as seen in Figure 39.
- Remove the following as indicated in Figure 40:
  - 2-pins connector cable
  - 3-pins connector cable
  - 4-pins connector white cable
  - 4-pins connector black cable
  - 8-pins connector cable

Figure 39



Figure 40

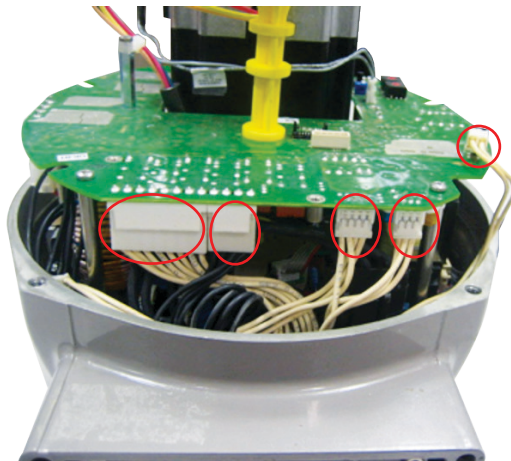

- Remove the 3-wire power connector cable from the power card as seen in Figure 41.
- Screw the 3 spacers and unscrew the screw that fixes the motor cable as seen in Figure 42.

Figure 41

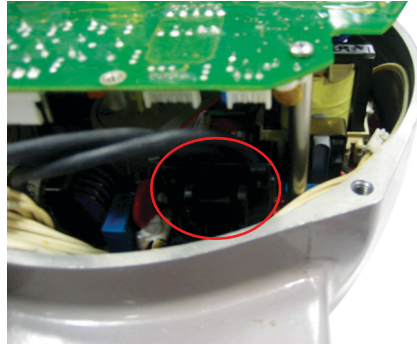
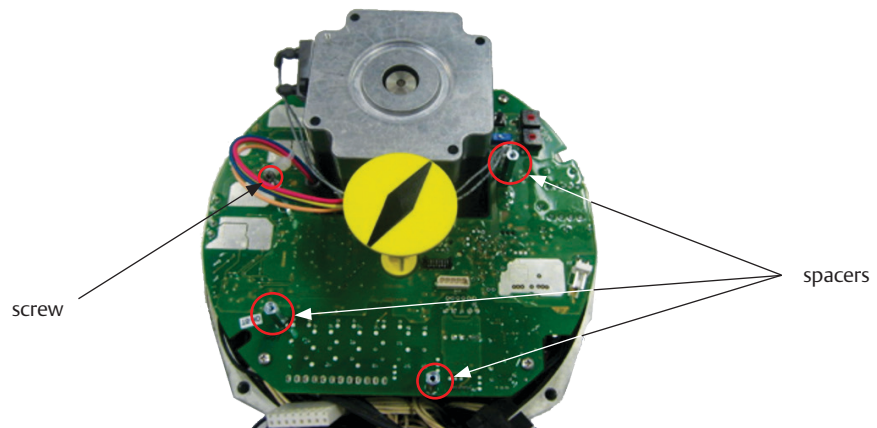

Figure 42



- Place the OM13 card onto the spacers and tighten the 4 screws as seen in Figure 43.
- Reconnect the 8-pins connector cable, the 4-pins connector black cable and the 4-pins connector white cable as seen in Figure 44.

Figure 43

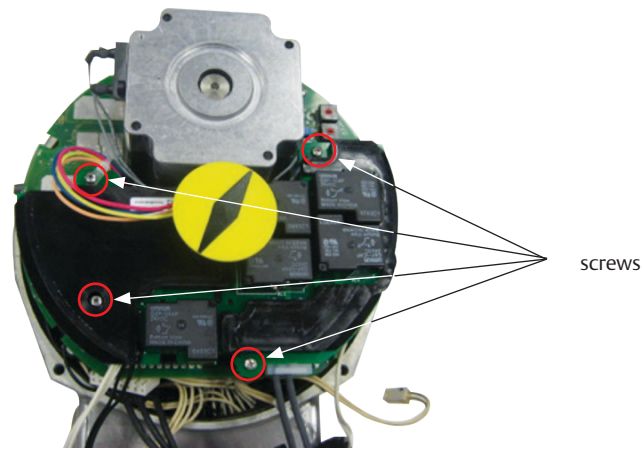
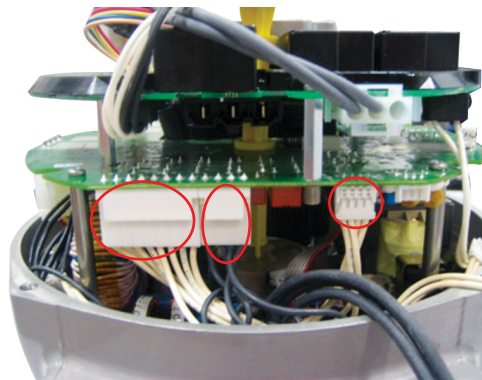

Figure 44



- Connect the 3-wire power connector cable from the terminal board to the OM13 as seen in Figure 45.
- Connect the 2-wire power connector cable of the OM13 card to the power card as seen in Figure 46.



Figure 45

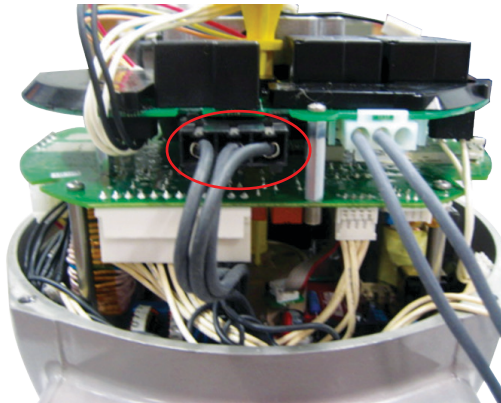
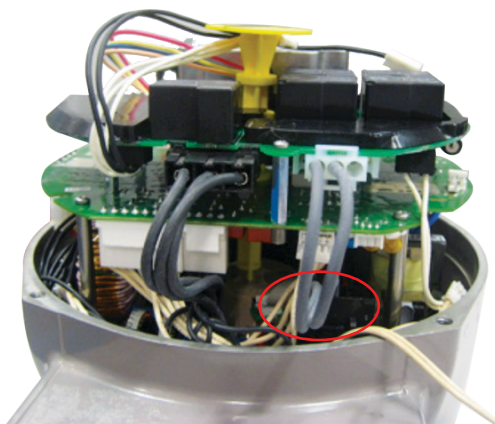

Figure 46



- Connect the 3-pins connector cable of the OM13 module to the logic card as seen in Figure 47.
- Connect the 2-pins black connector from OM13 module to the 2-pins connector previously removed as seen in Figure 48.
- Connect the 2-pins connector black cable from the OM13 module to connector on the logic card as seen in Figure 48.
- The OM13 card is now connected.
- Replace the actuator cover and fix it properly.

---

Figure 47

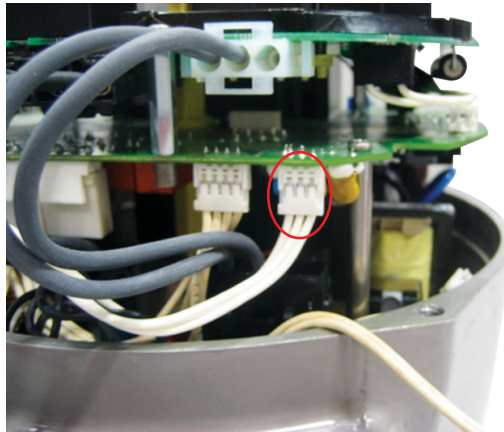

---

Figure 48

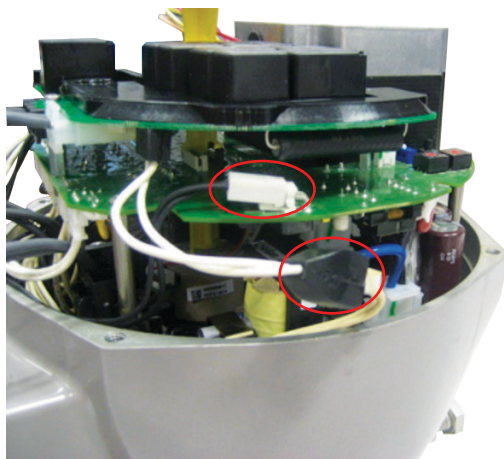

---

**NOTE:**

Please note that all the connectors provided with the base actuator and all optional cards are different from each other (in terms of design and number of pins). In no way is it possible to make a wrong connection.

---



# Section 3: OM13 Module Setting and Configuration

For the EPI2 basic actuator settings, please refer to the instruction and operation manual.

The OM13 does not need any setting and configuration.

## **WARNING**

Do not electrically operate the EPI2 when the electrical enclosures are removed. Operating the unit with the electrical enclosures removed could cause personal injury.

---

## Section 4: OM13 Kit

The OM13 kit consists of the following parts as indicated in Figure 49:

- OM13 modulating input/output module
- 3 pcs metal spacers
- 1 pc metal exagonal spacer 15 mm
- 3 pcs metal exagonal spacers 25 mm
- 1 plastic spacer
- 1 flat cable with connectors
- 3 screws M3x8
- 4 screws M3x10

This kit allows to assemble optional module OM13 over all different EPI2 models. Depending on models, only some spacers and screws has to be used.

Refer to Tables 1 and 2, and Figure 50 to choose the correct mechanical parts.

**Figure 49**

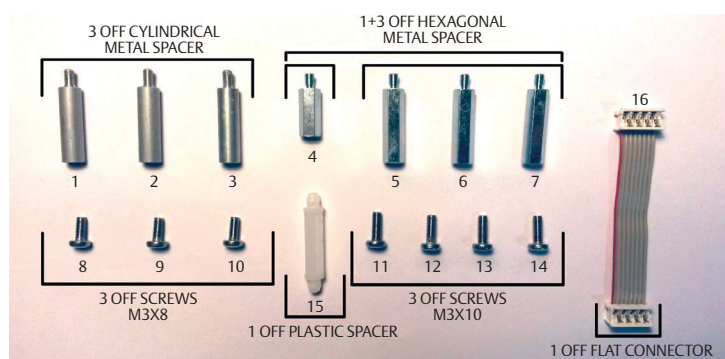

**Table 1.**

EPI2 Cross Reference Table (Non-US Market)				
Actuator model	Old 63-125	Old 250-2K	New 63-125	New 250-2K
Product coding chart digit X <sub>7</sub> X <sub>8</sub> 1-phase	UV - VU	UV - VU	LV - HV	LV - HV
Product coding chart digit X <sub>7</sub> X <sub>8</sub> 3-phase	31, 32, 33	31, 32, 33	3A, 3B, 3C	3A, 3B, 3C
A	1, 11	11	4, 8	5, 8
B	2, 12	12	1, 11	6, 9
C	3, 13	13	2, 12	7, 10
D	14	14	15	-

Table 2.

EPI2 Cross Reference Table (US Market)				
Actuator model	Old E006-E013	Old E025-E171	New E006-E013	New E025-E171
Product coding chart digit 6 1-phase	0 - 4	0 - 4	L - H	L - H
Product coding chart digit 6 3-phase	1, 2, 3	1, 2, 3	A, B, C	A, B, C
A	1, 11	11	4, 8	5, 8
B	2, 12	12	1, 11	6, 9
C	3, 13	13	2, 12	7, 10
D	14	14	15	-

Figure 50 Points A, B, C and D to Fix the Board on Standard Group

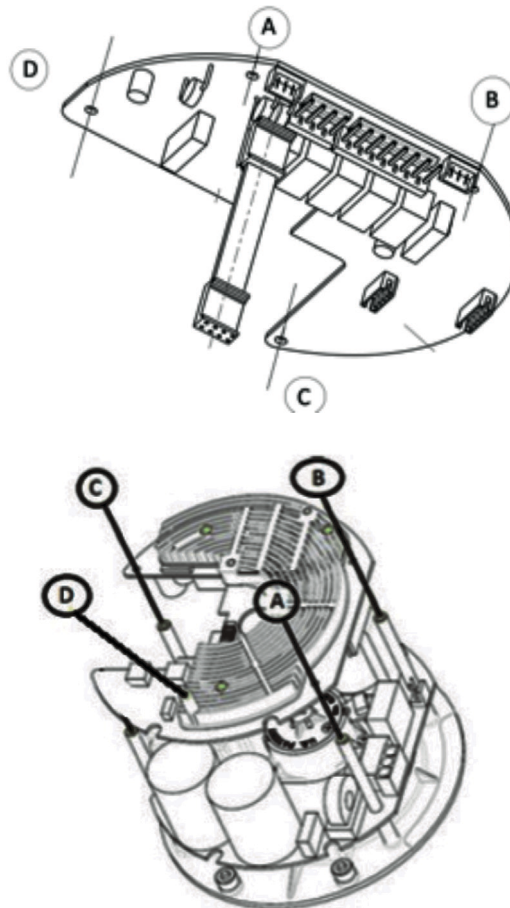

Figures 51-54 allow to distinguish old version of EPI2 from the new version (on the labels, the digits of Product Number are boxed); furthermore, the logic boards with heatsink identifies old version models, while logic boards without heatsink identifies new version models.

**Figure 51 Label for Non-Us Market - Digits X<sub>7</sub>X<sub>8</sub> on product coding chart**

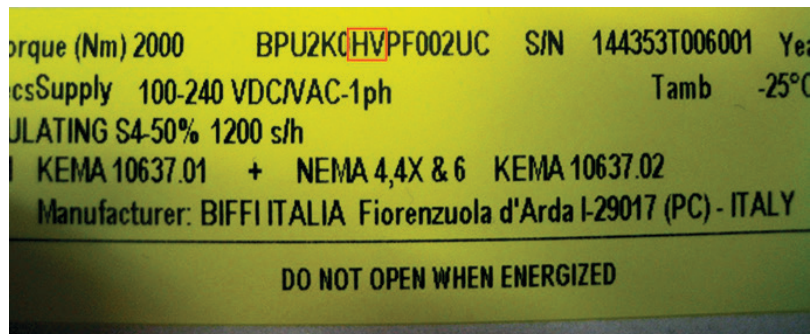

**Figure 52 Label for US Market – Digit 6 on Product Coding Chart**

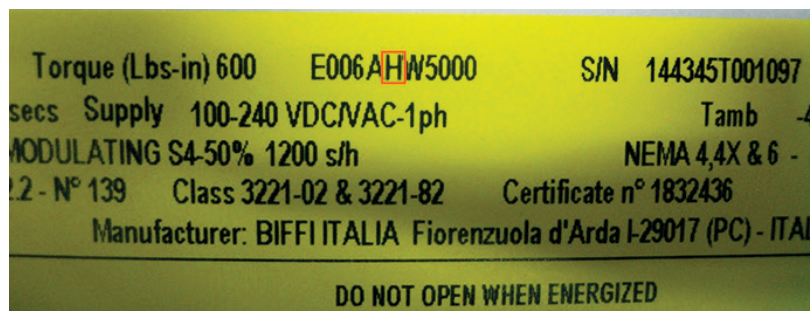

---

**Figure 53** Example of EPI2 Old Version (Heatsink Present)



---

**Figure 54** Example of EPI2 New Version (Heatsink Not Present)



## Section 5: OM13 Wiring Diagram

Figure 55

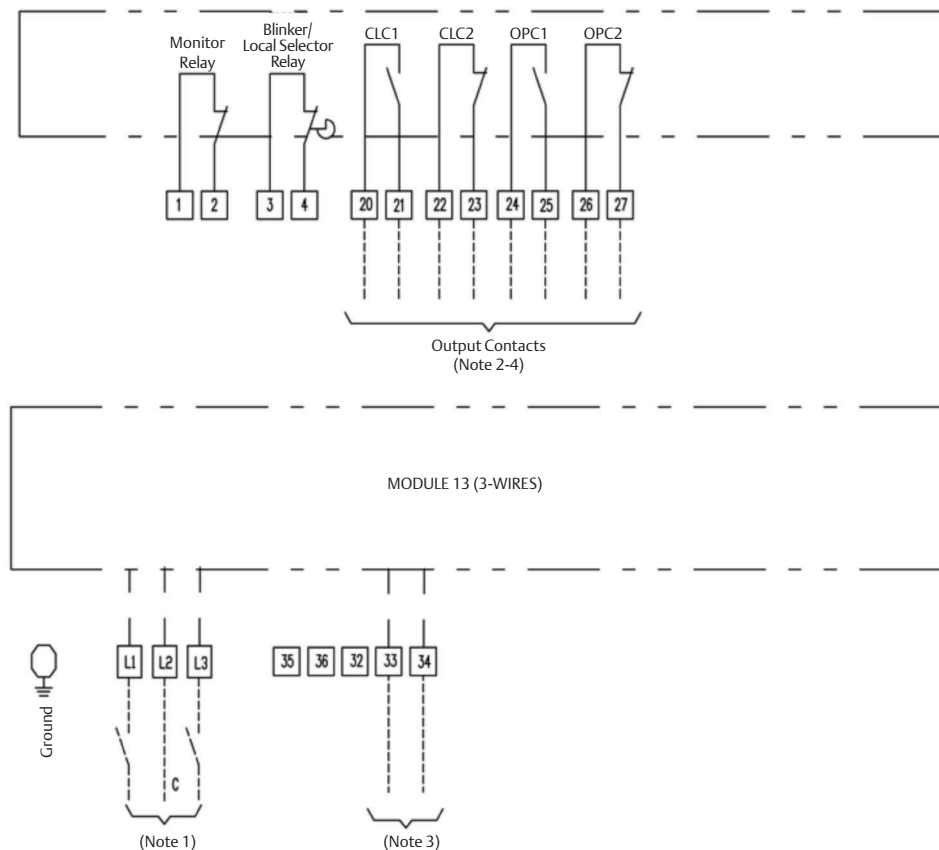
**NOTES:**

1. L1 - L2 connection to open  
L2 - L3 connection to close  
Supply from 110 to 240 V AC / 1-ph  
L2 neutral
2. Contacts shown in intermediate position CLC1 - CLC2 end of travel signaling in CLOSING  
Contacts shown in intermediate position OPC1 - OPC2 end of travel signaling in OPENING
3. Internal heater (max. 10 watt) is activated when a power supply from 110 to 240 V AC is connected to the terminals 33-34
4. Output contact rating: 240 V AC / 5 A - 30 V DC / 5 A - 120 V DC / 0.5 A

Alternatively, to avoid induced voltage phenomena over floating command line, the following wiring diagram may be used.

Figure 56

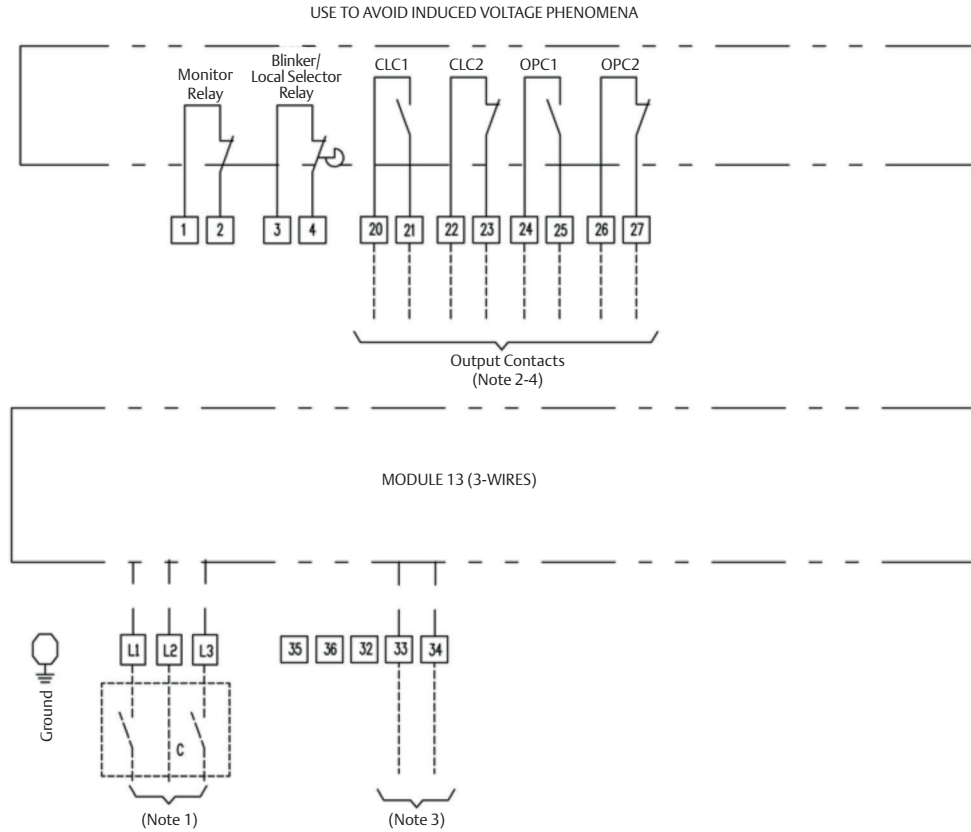

**NOTES:**

1. Supply from 110 to 240 V AC / 1-ph  
 L2 neutral  
 When L1 - L2 - L3 cables are long (more than 10 metres) induced voltage phenomena may occur on floating command line  
 To avoid this unwanted effect, realize a cabling system where unused line (either L1 OPEN or L3 CLOSE) is pulled to NEUTRAL line. To do this, a switch may be used.  
 For example with the BACO PN NC02GQ1, the following configuration may be used:  
 short circuit        pins 1 and 3  
 short circuit        pins 5 and 7  
 short circuit        pins 2 and 8  
 short circuit        pins 4 and 6  
 pin 3 = PHASE  
 pin 5 = NEUTRAL (L2)  
 pin 2 = OPEN (L1)  
 pin 4 = CLOSE (L3)
2. Contacts shown in intermediate position CLC1 - CLC2 end of travel signaling in CLOSING  
 Contacts shown in intermediate position OPC1 - OPC2 end of travel signaling in OPENING
3. Internal heater (max. 10 watt) is activated when a power supply from 110 to 240 V AC is connected to the terminals 33-344
4. Output contact rating: 240 V AC / 5 A - 30 V DC / 5 A - 120 V DC / 0.5 A

**World Area Configuration Centers (WACC) offer sales support, service, inventory and commissioning to our global customers. Choose the WACC or sales office nearest you:**

***NORTH & SOUTH AMERICA***

19200 Northwest Freeway  
Houston TX 77065  
USA  
T +1 281 477 4100

Av. Hollingsworth  
325 Iporanga Sorocaba  
SP 18087-105  
Brazil  
T +55 15 3413 8888

***ASIA PACIFIC***

No. 9 Gul Road  
#01-02 Singapore 629361  
T +65 6777 8211

No. 1 Lai Yuan Road  
Wuqing Development Area  
Tianjin 301700  
P. R. China  
T +86 22 8212 3300

***MIDDLE EAST & AFRICA***

P. O. Box 17033  
Jebel Ali Free Zone  
Dubai  
T +971 4 811 8100

P. O. Box 10305  
Jubail 31961  
Saudi Arabia  
T +966 3 340 8650

24 Angus Crescent  
Longmeadow Business Estate East  
P.O. Box 6908 Greenstone  
1616 Modderfontein Extension 5  
South Africa  
T +27 11 451 3700

***EUROPE***

Holland Fasor 6  
Székesfehérvár 8000  
Hungary  
T +36 22 53 09 50

Strada Biffi 165  
29017 Fiorenzuola d'Arda (PC)  
Italy  
T +39 0523 944 411

For complete list of sales and manufacturing sites, please visit [www.emerson.com/actuationtechnologieslocations](http://www.emerson.com/actuationtechnologieslocations) or contact us at [info.actuationtechnologies@emerson.com](mailto:info.actuationtechnologies@emerson.com)

[www.emerson.com](http://www.emerson.com)

VCIOM-01495-EN ©2022 Emerson. All rights reserved.

The Emerson logo is a trademark and service mark of Emerson Electric Co. Keystone™ is a mark of one of the Emerson family of companies. All other marks are property of their respective owners.

The contents of this publication are presented for informational purposes only, and while every effort has been made to ensure their accuracy, they are not to be construed as warranties or guarantees, express or implied, regarding the products or services described herein or their use or applicability. All sales are governed by our terms and conditions, which are available upon request. We reserve the right to modify or improve the designs or specifications of such products at any time without notice.

