

# Rosemount™ SPS 4001B

Single Probe Autocalibration Sequencer



# Table of Contents

	Essential Instructions .....	i
	Preface .....	ii
	Definitions .....	ii
	Symbols .....	ii
<b>SECTION 1</b>		
<b>Description and Specifications</b>	Component Checklist .....	1-1
	Overview .....	1-2
	Specifications .....	1-3
	Physical Description .....	1-4
	Theory of Operation .....	1-6
<b>SECTION 2</b>		
<b>Installation</b>	Overview .....	2-1
	Mechanical Installation .....	2-1
	Gas Connections .....	2-2
	Electrical Connections .....	2-4
<b>SECTION 3</b>		
<b>Operation</b>	Overview .....	3-1
	Calibration Requirements .....	3-1
	Reference Air Flow Setup .....	3-3
	Calibration Gas Flow Setup .....	3-3
	Automatic Calibration .....	3-3
	Semi-automatic Calibration .....	3-4
<b>SECTION 4</b>		
<b>Maintenance and Service</b>	Overview .....	4-1
	Fuse Replacement .....	4-2
	Remove/Install Chassis .....	4-4
	Circuit Board Replacement .....	4-6
	Solenoid Replacement .....	4-6
	Pressure Switch Replacement .....	4-7
	Check Valve Replacement .....	4-7
	Pressure Regulator Maintenance .....	4-7
	Flow Meter Adjustments .....	4-7
	Cleaning .....	4-7
<b>SECTION 5</b>		
<b>Troubleshooting</b>	Overview .....	5-1
	SPS 4001B Troubleshooting .....	5-1
<b>SECTION 6</b>		
<b>Replacement Parts</b>	SPS 4001B .....	6-2
	Calibration Components .....	6-3
<b>APPENDIX A</b>		
<b>Safety Data</b>	Safety Instructions .....	A-2
	.....	A-24
<b>APPENDIX B</b>		
<b>Return of Materials</b>	Returning Material .....	B-1



# SPS 4001B Single Probe Autocalibration Sequencer

## ESSENTIAL INSTRUCTIONS

### READ THIS PAGE BEFORE PROCEEDING!

Emerson designs, manufactures and tests its products to meet many national and international standards. Because these instruments are sophisticated technical products, you **MUST properly install, use, and maintain them** to ensure they continue to operate within their normal specifications. The following instructions **MUST be adhered to** and integrated into your safety program when installing, using, and maintaining Emerson's Rosemount products. Failure to follow the proper instructions may cause any one of the following situations to occur: Loss of life; personal injury; property damage; damage to this instrument; and warranty invalidation.

- **Read all instructions** prior to installing, operating, and servicing the product.
- If you do not understand any of the instructions, **contact your Emerson representative** for clarification.
- **Follow all warnings, cautions, and instructions** marked on and supplied with the product.
- **Inform and educate your personnel in the proper installation, operation, and maintenance of the product.**
- **Install your equipment as specified in the Installation Instructions of the appropriate Instruction Manual and per applicable local and national codes.** Connect all products to the proper electrical and pressure sources.
- To ensure proper performance, **use qualified personnel** to install, operate, update, program, and maintain the product.
- When replacement parts are required, ensure that qualified people use replacement parts specified by Emerson. Unauthorized parts and procedures can affect the product's performance, place the safe operation of your process at risk, **and VOID YOUR WARRANTY.** Look-alike substitutions may result in fire, electrical hazards, or improper operation.
- **Ensure that all equipment doors are closed and protective covers are in place, except when maintenance is being performed by qualified persons, to prevent electrical shock and personal injury.**

The information contained in this document is subject to change without notice.

**PREFACE**

The purpose of this manual is to provide information concerning the components, functions, installation and maintenance of the SPS 4001B Single Probe Autocalibration Sequencer.

Some sections may describe equipment not used in your configuration. The user should become thoroughly familiar with the operation of this module before operating it. Read this instruction manual completely.

**DEFINITIONS**

The following definitions apply to WARNINGS, CAUTIONS, and NOTES found throughout this publication.

** WARNING**

Highlights an operation or maintenance procedure, practice, condition, statement, etc. If not strictly observed, could result in injury, death, or long-term health hazards of personnel.

** CAUTION**





Highlights an operation or maintenance procedure, practice, condition, statement, etc. If not strictly observed, could result in damage to or destruction of equipment, or loss of effectiveness.

---

**NOTE**  
Highlights an essential operating procedure, condition, or statement.

---

**SYMBOLS**

-  : EARTH (GROUND) TERMINAL
-  : PROTECTIVE CONDUCTOR TERMINAL
-  : RISK OF ELECTRICAL SHOCK
-  : WARNING: REFER TO INSTRUCTION BULLETIN

---

**NOTE TO USERS**

The number in the lower right corner of each illustration in this publication is a manual illustration number. It is not a part number, and is not related to the illustration in any technical manner.

---



# Section 1 Description and Specifications

---

Component Checklist . . . . .	page 1-1
Overview . . . . .	page 1-2
Specifications . . . . .	page 1-3
Physical Description . . . . .	page 1-4
Theory of Operation . . . . .	page 1-6

---

## COMPONENT CHECKLIST

A typical SPS 4001B Single Probe Autocalibration Sequencer should contain the items shown in Figure 1-1. Record the part number, serial number, and order number for the SPS 4001B on the back cover of this manual.

### NOTE

The SPS 4001B operates exactly the same with either the Oxymitter 4000 Oxygen Transmitter or the Oxymitter 5000 Oxygen Transmitter with FOUNDATION fieldbus communications. Any references to the Oxymitter 4000 throughout this instruction manual also apply to the Oxymitter 5000.

Figure 1-1. SPS 4001B Package

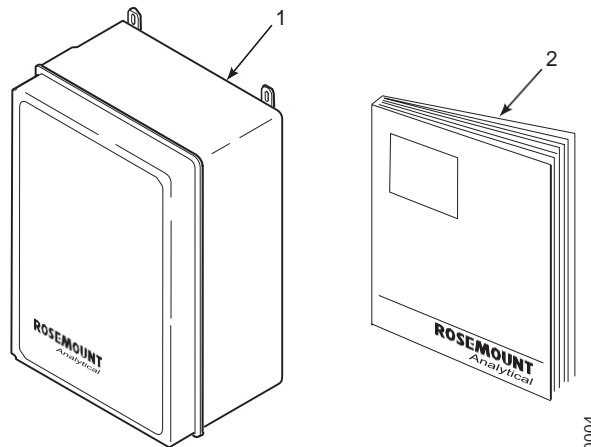

- 1. SPS 4001B
- 2. Instruction Manual

37470004

# SPS 4001B

---

## **OVERVIEW**

The SPS 4001B provides the capability of performing automatic, timed or on demand, calibrations of a single Oxymitter 4000 without sending a technician to the probe site.

The SPS 4001B replaces the SPS 4000, a similar unit with exposed analog devices mounted to a stainless steel support bracket. The operating parameters of the SPS 4000 and SPS 4001B are identical. All SPS units require additional calibration system components. These components, available from Emerson, are listed in Table 1-1.

The SPS 4001B is fully enclosed in a NEMA cabinet suited for wall-mounting. The enclosure provides added protection against corrosive atmospheres and incidental impact damage.

Emerson has offered multiprobe autocalibration sequencer systems for many years. These autocalibration systems are most cost effective for boilers and other combustion processes that utilize many probes. Users with only one probe per combustion process can take advantage of Emerson's autocalibration capability with the SPS 4001B.



**SPECIFICATIONS**

**Specifications**

SPS 4001B Assembly Part Number	6A00175G01
Mounting	Wall mount
Materials of Construction:	
Enclosure	Fiberglass
Manifold	Aluminum with 1/4 in. NPT ports
Pneumatic tubing - Low Pressure	Buna N with overbraid
Pneumatic tubing - High Pressure	Impolene
Assembly hardware	Galvanized and stainless steel
Humidity range	5 - 95% relative humidity, non condensing
Ambient temperature range	-40° to 149°F (-40° to 60°C) with optional heater -25° to 149°F (-5° to 60°C)
Enclosure protection	NEMA 4 (IP66)
Hazardous area option <sup>(1)</sup>	Z-purge (by owner)
Electrical entries	1/2 in. NPT (0.875 in. with gland)
Input power	90 to 250 VAC ±10%, 50/60 Hz
Power consumption	15VA maximum
External electrical noise	EN 61326-1 class A
Handshake signal to/from Oxymitter 4000 (self-powered)	5V (5mA maximum)
Cal initiate input from control room:	Internally 5V powered
In-Cal Relay Contact <sup>(4)(5)</sup>	5 to 30 VDC, 100 mA, Form A (SPST)
Cal Failed Relay Contact <sup>(4)(5)</sup>	5 to 30 VDC, 100 mA, Form A (SPST)
Cabling distance between SPS 4001B and Oxymitter 4000	Maximum 1000 ft (303 m)
Piping distance between SPS 4001B and Oxymitter 4000 <sup>(2) (3)</sup>	Maximum 300 ft (91 m)
Instrument Air	Maximum 100 psi (689 kPa)
Calibration Gases	25 psi (172 kPa)
Approximate shipping weight	10 lbs (4.5 kg)
Pollution degree	2
Overvoltage Category	II
Certification	General Purpose



**NOTES**

- (1) Hazardous area option requires the addition of a Z-purging system by the owner.
- (2) Reference air is recommended with 9 ft (2.74 m) and 12 ft (3.66 m) long probes. Reference air is also recommended when ambient air may not contain the normal 20.95% O<sub>2</sub>, such as when the probe is mounted into a positive pressure duct with leaks or where there is a process unit nearby with leaks.
- (3) Customer to provide piping from remote SPS 4001B to probe.
- (4) External current limiting device must be provided by customer.
- (5) If contacts are used to drive relay coils, a reverse blocking (flyback) diode must be installed on the input to the relay coil. Relay and diode to be provided by customer.

Table 1-1. Calibration Components

PART NUMBER	DESCRIPTION
1A99119G01	Two disposable calibration gas bottles - 0.4% and 8% O <sub>2</sub> , balance nitrogen - 550 liters each <sup>(1)(2)</sup>
1A99119G02	Two flow regulators for calibration gas bottles
1A99119G03	Bottle rack

**NOTES**

(1) Calibration gas bottles cannot be shipped via airfreight.

(2) When the bottles are used with "CALIBRATION RECOMMENDED" features, the bottles should provide 2 to 3 years of calibrations in normal service.

## PHYSICAL DESCRIPTION

The main components of the SPS 4001B are illustrated in Figure 1-2.

### Manifold

The manifold provides porting to and from the calibration solenoids. The manifold ports are accessible from outside the enclosure for making piping connections. The Oxymitter 4000 calibration gases are piped into and sequenced through the calibration gas solenoids mounted on the manifold.

Figure 1-2. SPS 4001B Components

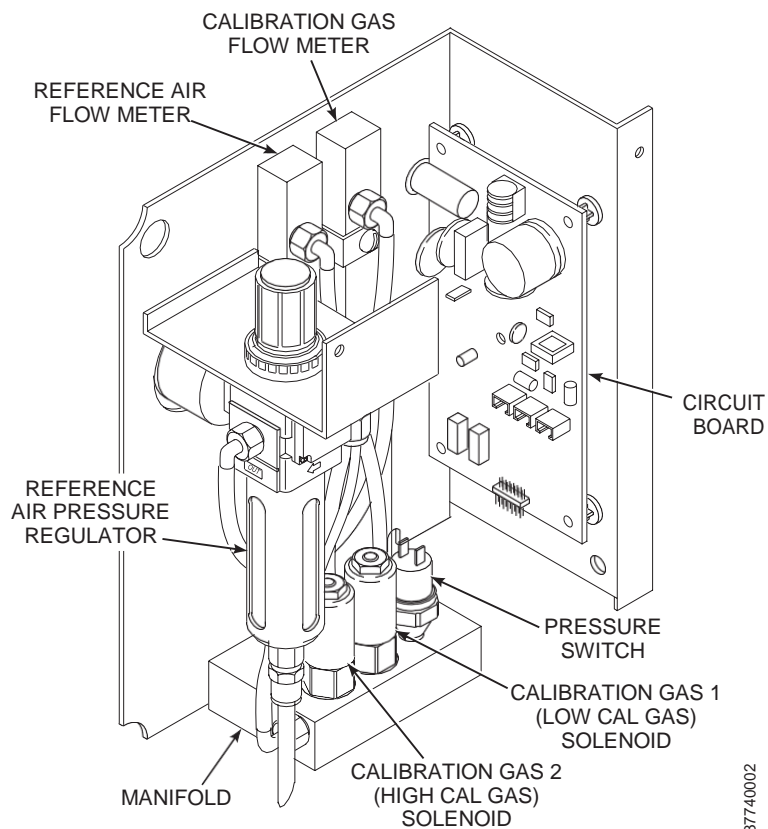

### **Calibration Gas Solenoids**

The solenoids sequence the calibration gases. One solenoid controls calibration gas 1 (high calibration gas), and the other controls calibration gas 2 (low calibration gas). The solenoids activate and deactivate to allow the calibration gases to flow between the sequencer and Oxymitter 4000.

### **Pressure Switch**

The pressure switch detects if the pressure of a calibration gas is low, which can be caused by an empty gas bottle, a disconnected gas line, etc. Calibration is prohibited when calibration gas pressure is low.

### **Circuit Board**

The circuit board converts the incoming line voltage from AC to DC for use by the solenoids, terminations, and the programmable logic device. The power circuit is protected by a 1.6 A, 250 V, fast acting fuse.

The board contains a programmable logic device (PLD) that has the electronics to energize and deenergize the solenoids based on a signal from the Oxymitter 4000.

A terminal strip provides convenient access for all signal and power user connections.

### **Calibration Gas Flow Meter**

The calibration gas flow meter indicates the flow rate of calibration gas flowing to the Oxymitter 4000.

### **Reference Air Flow Meter**

The reference air flow meter indicates the amount of reference air continuously flowing to the Oxymitter 4000.

### **Pressure Regulator**

The pressure regulator ensures the instrument air (reference air) flowing to the Oxymitter 4000 is at a constant pressure [25 psi (172 kPa)]. The regulator also has a filter to remove particulates in the reference air and a drain valve to bleed the moisture that collects in the filter bowl.

# SPS 4001B

---

## THEORY OF OPERATION

The Oxymitter 4000 is one of the few instruments found in industry that permit the permanent piping of a calibration standard into the probe. Most instruments measuring pressure, flow, or temperature, require that a calibration standard be brought to the instrument or that the instrument be taken to the calibration source in the instrument shop.

The permanent calibration gas connections allow for autocalibrations to occur without operator intervention. The following paragraphs describe how an Oxymitter 4000 is autocalibrated when used with the SPS 4001B.

In addition to the calibration methods available via the Oxymitter 4000 keypad, HART communicator, AMS software, or a remote contact, the SPS 4001B works in conjunction with the Oxymitter 4000's CAL RECOMMENDED feature to perform an autocalibration.

This feature automatically performs an impedance check every hour on the Oxymitter 4000. If a calibration is recommended and its contact output signal is set for "handshaking" with the SPS 4001B sequencer, the Oxymitter 4000 sends a signal to the sequencer. The sequencer automatically performs a calibration upon receiving the signal. Therefore, no human interface is required for the automatic calibration to take place.

See Figure 1-3. When a calibration is required, the Oxymitter 4000 sends a signal to the programmable logic device (PLD) on the interface board of the sequencer. The PLD energizes the calibration gas 1 (high O<sub>2</sub>) solenoid. Calibration gas 1 then flows through the sequencer to the Oxymitter 4000. The Oxymitter 4000 measures the oxygen content of calibration gas 1 and sends a signal to the sequencer indicating that it received the gas. When the sequencer receives the signal, the PLD deenergizes the calibration gas 1 solenoid.

Next, the PLD energizes the calibration gas 2 (low O<sub>2</sub>) solenoid, and calibration gas 2 then flows through the sequencer to the Oxymitter 4000. The Oxymitter 4000 measures the oxygen content of calibration gas 2 and sends a signal to the sequencer indicating that it received the gas. After measuring the two calibration gases, the Oxymitter 4000 automatically makes an internal calibration adjustment and sends the signal to the sequencer. When the sequencer receives the signal, the PLD deenergizes the calibration gas 2 solenoid.

Figure 1-3. SPS 4001B Calibration Setup

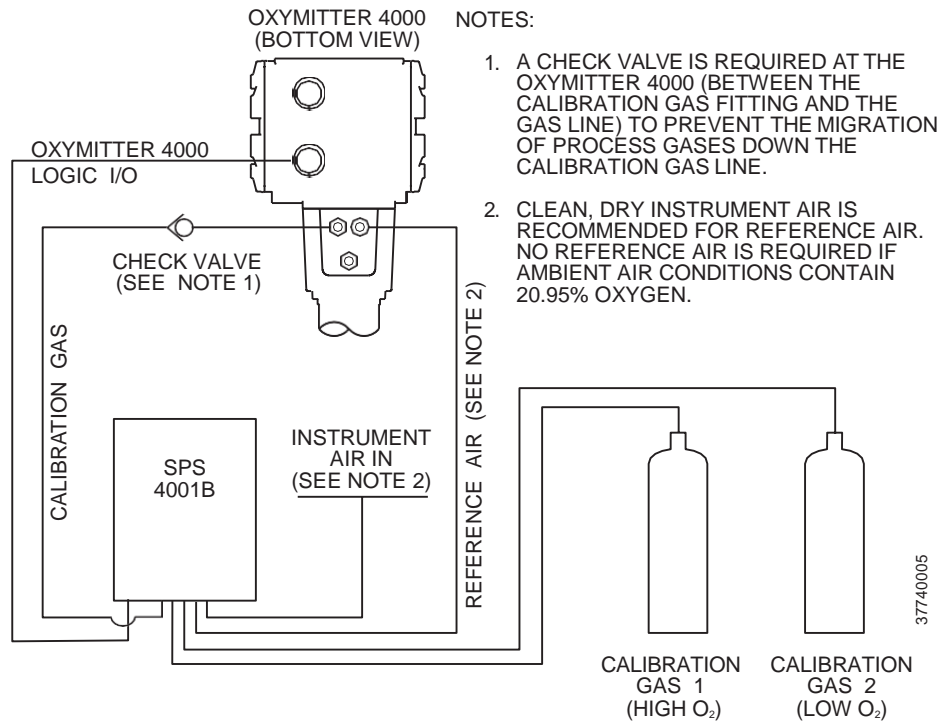



# Section 2 Installation

---

Overview .....	page 2-1
Mechanical Installation .....	page 2-1
Gas Connections .....	page 2-2
Electrical Connections .....	page 2-4

---

## OVERVIEW

This section describes SPS 4001B installation.

**⚠ WARNING**

Before starting to install this equipment, read the "Safety instructions for the wiring and installation of this apparatus" in Section A: Safety Data. Failure to follow the safety instructions could result in serious injury or death.

**⚠ WARNING**

Secure equipment cover and ground leads after installation. Failure to secure covers and ground leads could result in serious injury or death.

**⚠ WARNING**

The SPS 4001B is only intended for use in general purpose, ordinary locations (non-hazardous). Do not install the SPS4001B in areas where flammable or ignitable substabces are present.

## MECHANICAL INSTALLATION

The outline drawing in Figure 2-1 shows mounting centers and clearances of the SPS 4001B. The unit is designed to mount on a wall, bulkhead, or pipe. Ensure the unit is installed according to the following specifications.

1. Install the unit no further than 300 ft (91 m) from the Oxymitter 4000 and no further than 1000 ft (303 m) from the electronics package or any customer-supplied remote input or relay output in the control room.
2. Locate the unit where the ambient temperature is between -25° and 149°F (-5° and 60°C) or -40° and 149°F (-40° and 60°C) with optional heater.

**GAS CONNECTIONS**

Use the following procedures to connect the reference air and the calibration gases.

**Reference Air (Figure 2-1)****⚠ WARNING**

Do not exceed maximum pressure for instrument air. Failure to limit pressure could result in equipment failure, serious injury or death.

The Oxymitter 4000 requires a source of reference air that is constantly 20.95% O<sub>2</sub>. Clean and dry instrument air provides the most stable source of reference air. If instrument air is unavailable, the reference air port of the probe can be left open, permitting ambient air to passively diffuse into the probe.

1. Connect the instrument air supply to the INST AIR IN port of the manifold.
2. The pressure regulator is factory set at 25 psi (172 kPa). If necessary, readjust by turning the knob on the top of the regulator until the desired pressure is obtained.
3. Next, connect the reference air from the REF GAS OUT port of the manifold to the REF GAS port on the Oxymitter 4000.

**Calibration Gas (Figure 2-1)**

1. Connect O<sub>2</sub> calibration gas 1 (high calibration gas) to the HI GAS IN port on the manifold. Ensure the calibration gas pressure is set at 25 psi (172 kPa).

**⚠ CAUTION**

Instrument air is not recommended for the high calibration gas. Do not use 100% nitrogen as a low gas (zero gas). It is suggested that the low (zero) gas be between 0.4% and 2.0% O<sub>2</sub>. Do not use gases with hydrocarbon concentrations of more than 40 parts per million. Failure to use proper gases will result in erroneous readings.

2. Connect O<sub>2</sub> calibration gas 2 (low calibration gas) to the LOW GAS IN port on the manifold. Ensure the calibration gas pressure is set at 25 psi (172 kPa).
3. Connect the calibration gas from the CAL GAS OUT manifold fitting to the check valve connected to the CAL GAS port on the Oxymitter 4000.



Figure 2-1. Installation

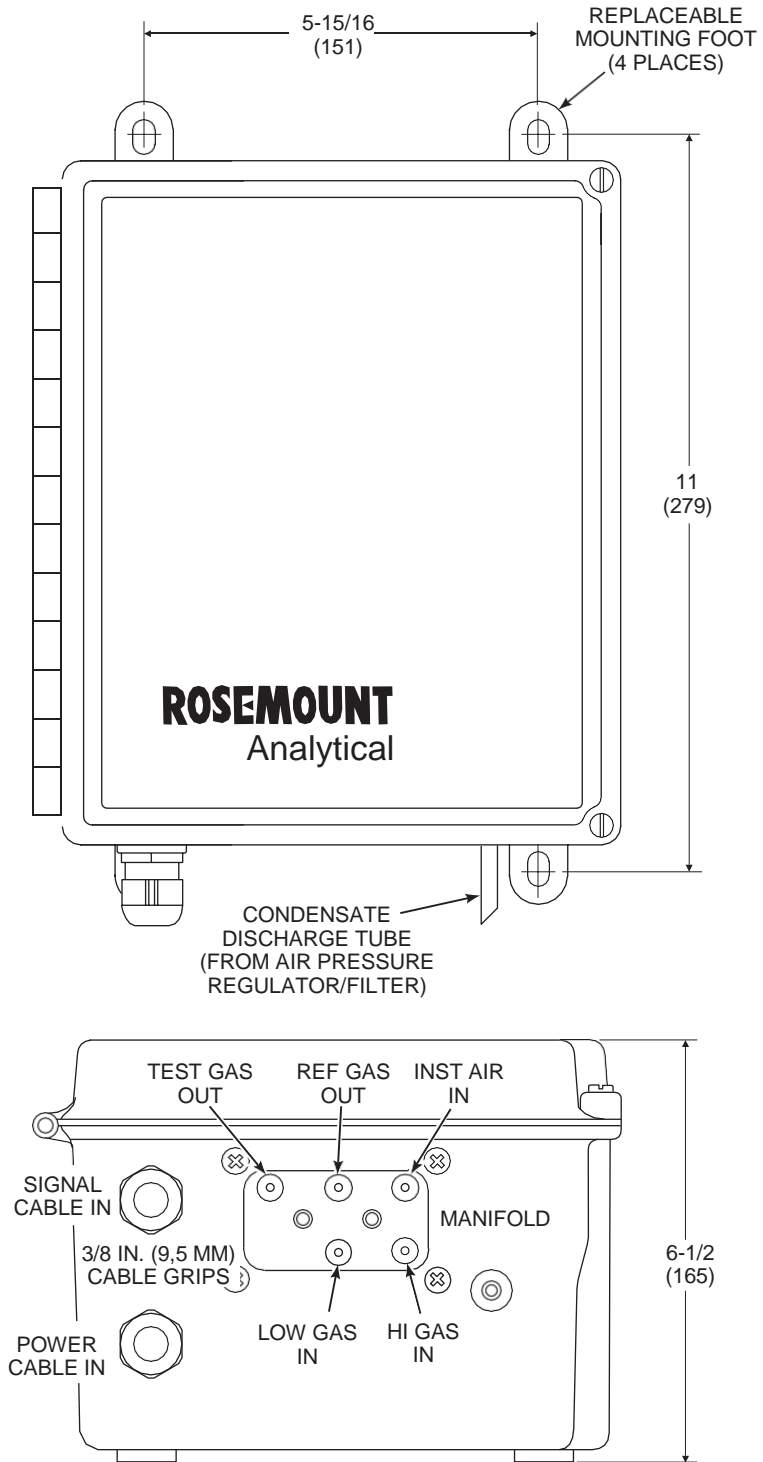

NOTE: DIMENSIONS ARE IN INCHES WITH MILLIMETERS IN PARENTHESES.

37470007

## ELECTRICAL CONNECTIONS

All wiring must conform to local and national codes. Use the following procedure to connect an SPS 4001B to an Oxymitter 4000.

### **⚠ WARNING**

Disconnect and lock out power before connecting the unit to the power supply. Failure to lock out power could result in serious injury or death.

### **⚠ WARNING**

Install all protective equipment covers and safety ground leads after installation. Failure to install covers and ground leads could result in serious injury or death.

### **⚠ WARNING**

To meet the Safety Requirements of IEC 1010 (EC requirement), and ensure safe operation of this equipment, connection to the main electrical power supply must be made through a circuit breaker (min 10 A) in close proximity and marked for this equipment which will disconnect all current-carrying conductors during a fault situation. This circuit breaker should also include a mechanically operated isolating switch. If not, then another external means of disconnecting the supply from the equipment should be located close by. Circuit breakers or switches must comply with recognized standards such as IEC 947.

### **NOTE**

Ensure the Oxymitter 4000 is set up to handshake with the sequencer by configuring the logic I/O to mode 8. Refer to the Oxymitter 4000 Oxygen Transmitter Instruction Manual for more information.

### **NOTE**

To maintain proper earth grounding, ensure a positive connection exists between the ground lug and earth. Install this wire or ground lug first.

1. Loosen the SPS 4001B cover screws and open the cover.
2. Route the line voltage cable into the enclosure through the rear cable grip. Ensure adequate wire length to connect the line voltage leads per Figure 2-2, then tighten the cable grip nut.
3. Connect the incoming 90 to 250 VAC  $\pm 10\%$ , 50/60 Hz line voltage leads to the terminal strip and ground lug as indicated in Figure 2-2.
4. Route the signal wiring cable through the front cable grip. Ensure adequate wire length to connect all signal wires per Figure 2-2, then tighten the cable grip nut. Use shielded twisted pair wiring. Terminate the shield at the SPS 4001B.

5. Connect the 5V (5 mA maximum) logic I/O leads from the Oxymitter 4000 to the terminal strip as indicated in Figure 2-2. Use shielded twisted pair wiring. Terminate the shield at the Oxymitter 4000.
6. To set up the SPS 4001B to initiate a calibration from a remote location, connect the 5 VDC input leads to the terminal strip as shown in Figure 2-2.
7. Relay output connections are available on the unit to signal when the Oxymitter 4000 is in calibration or when calibration failed. Relay outputs can be connected to either indicator lights or a computer interface. The relay contacts are capable of handling a 5 to 30 VDC maximum power source. The cabling requirement is 1000 ft (303 m) maximum. Connect the relay output wires to the terminal strip as shown in Figure 2-2. Use shielded twisted pair wiring. Terminate the shield at the SPS 4001B.
8. Once all connections are made, close the enclosure cover and tighten the cover screws.

Figure 2-2. Electrical Connections

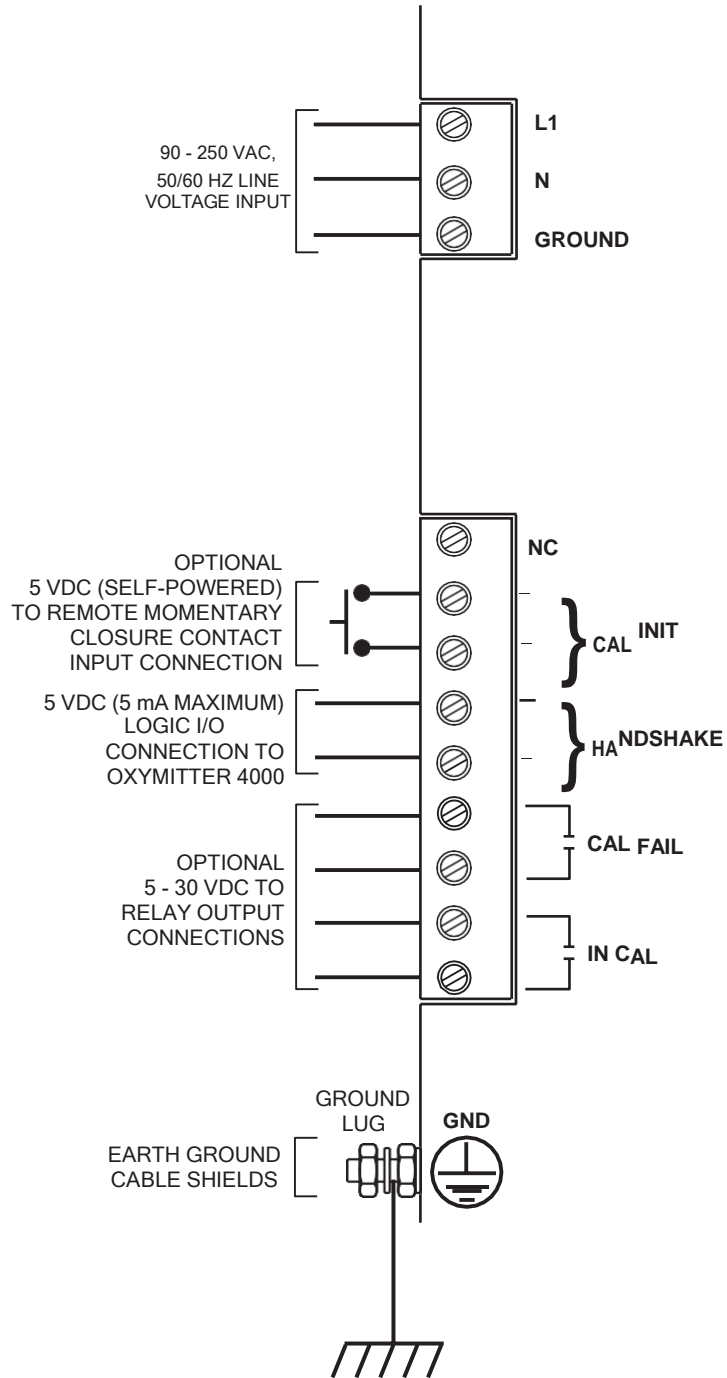

37740003

---

## Section 3      Operation

---

Overview .....	page 3-1
Calibration Requirements .....	page 3-1
Reference Air Flow Setup .....	page 3-3
Calibration Gas Flow Setup .....	page 3-3
Automatic Calibration .....	page 3-3
Semi-automatic Calibration .....	page 3-4

---

### OVERVIEW

This section specifies the requirements to set up an Oxymitter 4000 calibration and how to verify the calibration gas flow setup. It also explains the differences between automatic and semi-automatic calibrations and how to initiate them.

### CALIBRATION REQUIREMENTS

#### Calibration Gas Tanks

Two tanks of precision calibration gas mixtures are required. Recommended calibration gases are nominally 0.4% and 8.0% oxygen in nitrogen.

#### CAUTION

Do not use 100% nitrogen as a low gas (zero gas). It is suggested that gas for the low (zero) be between 0.4% and 2.0% O<sub>2</sub>. Do not use gases with hydrocarbon concentrations of more than 40 parts per million. Failure to use proper gases will result in erroneous readings.

In addition to the optional disposable gas bottles available from Emerson, two additional sources of calibrated gas mixtures are:

**LIQUID CARBONIC GAS CORP.  
SPECIALTY GAS LABORATORIES**

700 South Alameda Street  
Los Angeles, California 90058  
213/585-2154

767 Industrial Road  
San Carlos, California 94070  
415/592-7303

9950 Chemical Road  
Pasadena, Texas 77507  
713/474-4141

12054 S.W. Doty Avenue  
Chicago, Illinois 60628  
312/568-8840

603 Bergen Street  
Harrison, New Jersey 07029  
201/485-1995

255 Brimley Road  
Scarborough, Ontario, Canada  
416/266-3161

**SCOTT ENVIRONMENTAL  
TECHNOLOGY, INC.  
SCOTT SPECIALTY GASES**

2600 Cajon Blvd.  
San Bernardino, California 92411  
714/887-2571  
TWX: 910-390-1159

1290 Combermere Street  
Troy, Michigan 48084  
314/589-2950

Route 611  
Plumsteadville, Pennsylvania 18949  
215/766-8861  
TWX: 510-665-9344

2616 South Loop West  
Suite 100  
Houston, Texas 77054  
713/669-0469

**Check Valve**

A check valve is required at the Oxymitter 4000 (between the calibration fitting and the gas line) to prevent the migration of process gases down the calibration gas line between calibrations.

A typical calibration setup for the Oxymitter 4000 is shown in Figure 1-3.

---

## REFERENCE AIR FLOW SETUP

If instrument air is to be used as the reference gas, set the reference air pressure regulator to 25 psi (172 kPa gage) and set the reference air flow meter to 2 scfh. Refer to the Reference Air Package in the Oxymitter 4000 Instruction Manual for more information.

## CALIBRATION GAS FLOW SETUP

After installing the SPS 4001B as described in Section 2, Installation, calibrate the Oxymitter 4000 to verify SPS 4001B operation and the communication link between the sequencer and Oxymitter 4000.

1. Verify that both calibration gases are connected to the SPS 4001B. Also verify that the pressure regulators on both calibration gas bottles are set to 25 psi (172 kPa).
2. Initiate a semi-automatic calibration using one of the methods in "Semi-automatic Calibration".

---

### NOTE

Set the calibration gas flow meter only upon initial installation and after changing the diffusion element in the Oxymitter 4000. Refer to the flow meter adjustments in Section 4, Maintenance and Service for more information.

3. As the Oxymitter 4000 and SPS 4001B apply the first calibration gas, set the calibration gas flow meter to 5 scfh. When the second calibration gas is applied, verify that the flow meter reads 5 scfh. If not, adjust the pressure regulator on the second calibration gas bottle so the 5 scfh flow is provided.

## AUTOMATIC CALIBRATION

Automatic calibrations require no operator action and can be performed through the Oxymitter 4000 CAL RECOMMENDED feature or through scheduled time intervals that can be programmed through the HART/AMS for the Oxymitter 4000. In addition, the calibration gases must be permanently piped to the Oxymitter 4000.

### Cal Recommended

If the Oxymitter 4000 is configured for handshake mode with the SPS 4001B, the Oxymitter 4000 can initiate a calibration by sending a signal to the sequencer when the CAL RECOMMENDED LED activates. To enable handshake mode, the Oxymitter 4000 logic I/O must be set for mode 8 or mode 9 (handshake).

The handshake mode is configured at the factory or can be accessed through HART/AMS. Refer to the logic I/O information in the HART/AMS section of the Oxymitter 4000 Instruction Manual for more information.

### Timed Interval

An automatic calibration can also be programmed to occur at a specific time interval, in hours, using the HART communicator or AMS software. Refer to the HART/AMS section of the Oxymitter 4000 Oxygen Transmitter Instruction Manual for this procedure.

## **SEMI-AUTOMATIC CALIBRATION**

Semi-automatic calibrations are operator initiated and can be performed using the Oxymitter 4000 keypad, HART handheld communicator/AMS software, or a remote contact. In addition, the calibration gases must be permanently piped to the Oxymitter 4000.

### **Oxymitter 4000 Keypad**

A semi-automatic calibration can be initiated by pressing the CAL button on the Oxymitter 4000 keypad. For more information, refer to the Oxymitter 4000 Oxygen Transmitter Instruction Manual.

### **HART Handheld Communicator/AMS Software**

A semi-automatic calibration can be initiated by connecting the HART handheld communicator, or AMS software, to the Oxymitter 4000 4-20 mA signal line and using the HART communicator keypad or computer keyboard to access the applicable calibration menu. Refer to the Oxymitter 4000 Oxygen Transmitter Instruction Manual or HART documentation for more information.

### **Remote Contact**

A semi-automatic calibration can be initiated using a remote contact such as a customer's control system. The remote contact processes the calibration command on a PC and sends the signal to the Oxymitter 4000. For more information on remote-site calibrations, refer to the documentation for the system in use.



---

## Section 4 Maintenance and Service

---

Overview .....	page 4-1
Fuse Replacement .....	page 4-2
Remove/Install Chassis .....	page 4-4
Circuit Board Replacement .....	page 4-6
Solenoid Replacement .....	page 4-6
Pressure Switch Replacement .....	page 4-7
Check Valve Replacement .....	page 4-7
Pressure Regulator Maintenance .....	page 4-7
Flow Meter Adjustments .....	page 4-7
Cleaning .....	page 4-7

---

### OVERVIEW

This section describes service and routine maintenance of the SPS 4001B. Replacement parts are available from Emerson. Refer to Section 6, Replacement Parts for part numbers and ordering information

**⚠ WARNING**

Secure equipment cover and ground leads after equipment service. Failure to secure covers and ground leads could result in serious injury or death.

## FUSE REPLACEMENT

The SPS 4001B has a fuse on the circuit board. Refer to Section 6, Replacement Parts for replacement fuse specifications. Perform the following procedure to check or replace the fuse

**⚠ WARNING**

Disconnect and lock out power before working on any electrical components.

**⚠ WARNING**

Replace fuse only with same type and rating as specified.

1. Turn off power to the system and open the enclosure cover.
2. Push in and turn the fuseholder cap 1/4 turn counterclockwise. Remove the fuse.
3. After checking or replacing the fuse, install fuseholder cap. Push in and turn the cap 1/4 turn clockwise.
4. Install the enclosure cover and secure the cover screws.

Figure 4-1. SPS 4001B, Exploded View

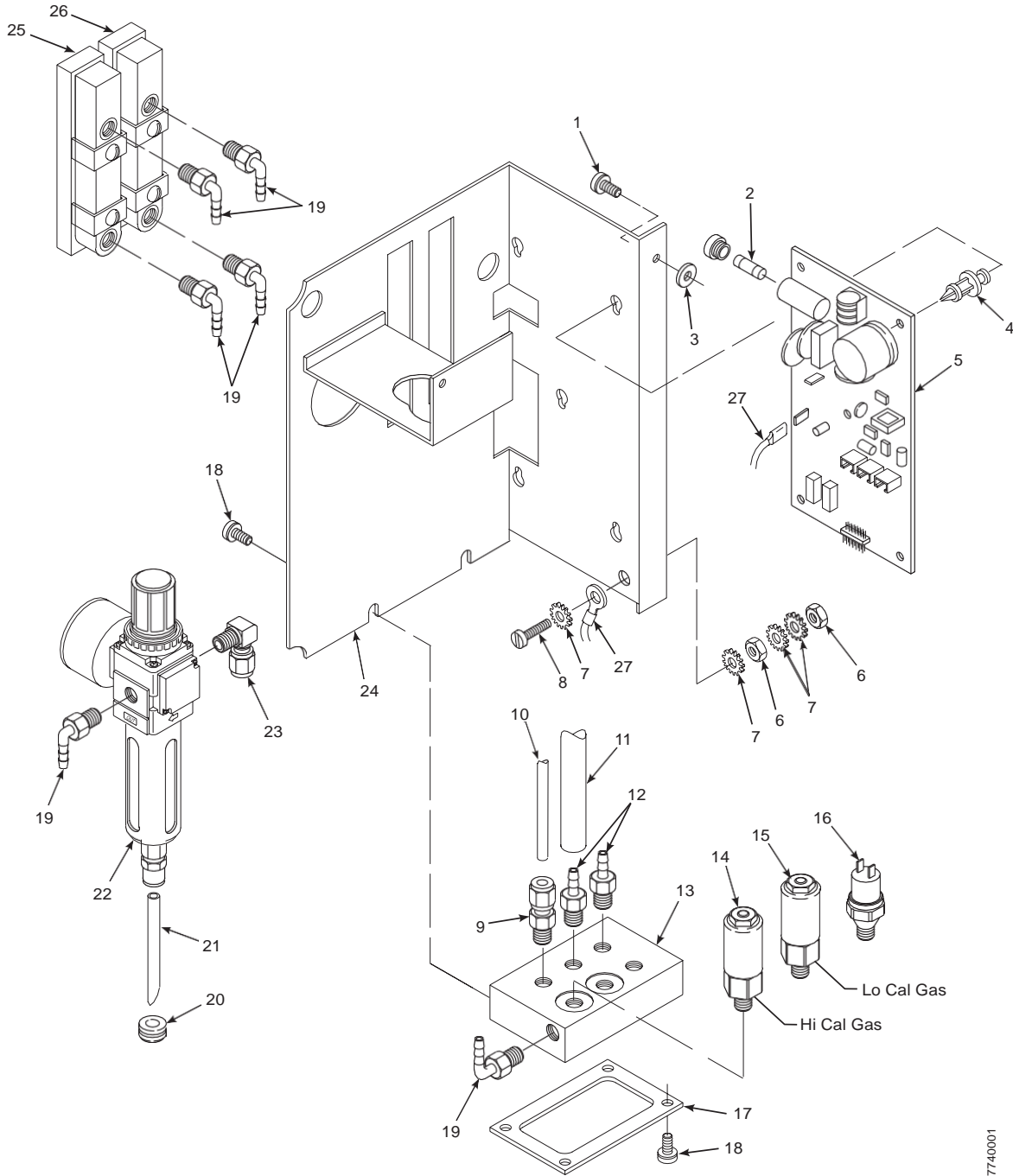

37740001

- |                         |                            |                           |                                      |
|-------------------------|----------------------------|---------------------------|--------------------------------------|
| 1. Screw                | 8. Screw                   | 15. Low Cal. Gas Solenoid | 22. Reference Air Pressure Regulator |
| 2. Fuse                 | 9. Adapter Fitting         | 16. Pressure Switch       | 23. Elbow Adapter                    |
| 3. Nylon Washer         | 10. Impolene Tubing        | 17. Manifold Gasket       | 24. Chassis                          |
| 4. Standoff             | 11. Tubing                 | 18. Screw                 | 25. Reference Air Flow Meter         |
| 5. Circuit Board        | 12. Straight Fitting       | 19. Elbow Fitting         | 26. Cal. Gas Flow Meter              |
| 6. Hex Nut              | 13. Manifold               | 20. Grommet               | 27. Ground Wire                      |
| 7. External Lock Washer | 14. High Cal. Gas Solenoid |                           |                                      |

## **REMOVE/INSTALL CHASSIS**

Perform the following procedures to remove the SPS 4001B chassis from the enclosure for service, and to reinstall the chassis after the service tasks are completed.

### **Removal**

1. Loosen the SPS 4001B cover screws and open the cover.
2. Shut off the calibration gas and reference air to the SPS 4001B. Disconnect all pneumatic lines at the SPS 4001B manifold.
3. Refer to Figure 2-2. Disconnect all wires from the chassis terminals and remove the power cable ground lead from the ground lug.
4. Refer to Figure 4-1. Remove two screws (18) that secure chassis (24) to manifold (13).
5. Loosen captive screw (1) that secures chassis (24) to enclosure.
6. Place one hand on the front of chassis (24) and tip the enclosure up-side-down. Remove chassis from enclosure and place chassis and enclosure on work surface.

### **Installation**

1. Push up on the base of the fitting installed at the bottom of reference air pressure regulator (22, Figure 4-1). Pull teflon tubing (21) from the fitting.
2. Stand chassis (24) and enclosure upright and carefully place the chassis in the enclosure.
3. Tighten captive screw (1).
4. Install and tighten two screws (18) to secure the base of the chassis.
5. Insert teflon tubing (21) through grommet (20) in bottom of enclosure. Seat the tubing in mating adapter fitting at the bottom of reference air pressure regulator (22).
6. Refer to Figure 4-2. Connect all signal and power wiring to the chassis terminals and connect the power cable ground lead to the groundlug.
7. Connect all pneumatic lines at the SPS 4001B manifold. Turn on the calibration gas and reference air supplies to the SPS 4001B.
8. Close the enclosure cover and secure the cover screws.

Figure 4-2. Terminal Connections

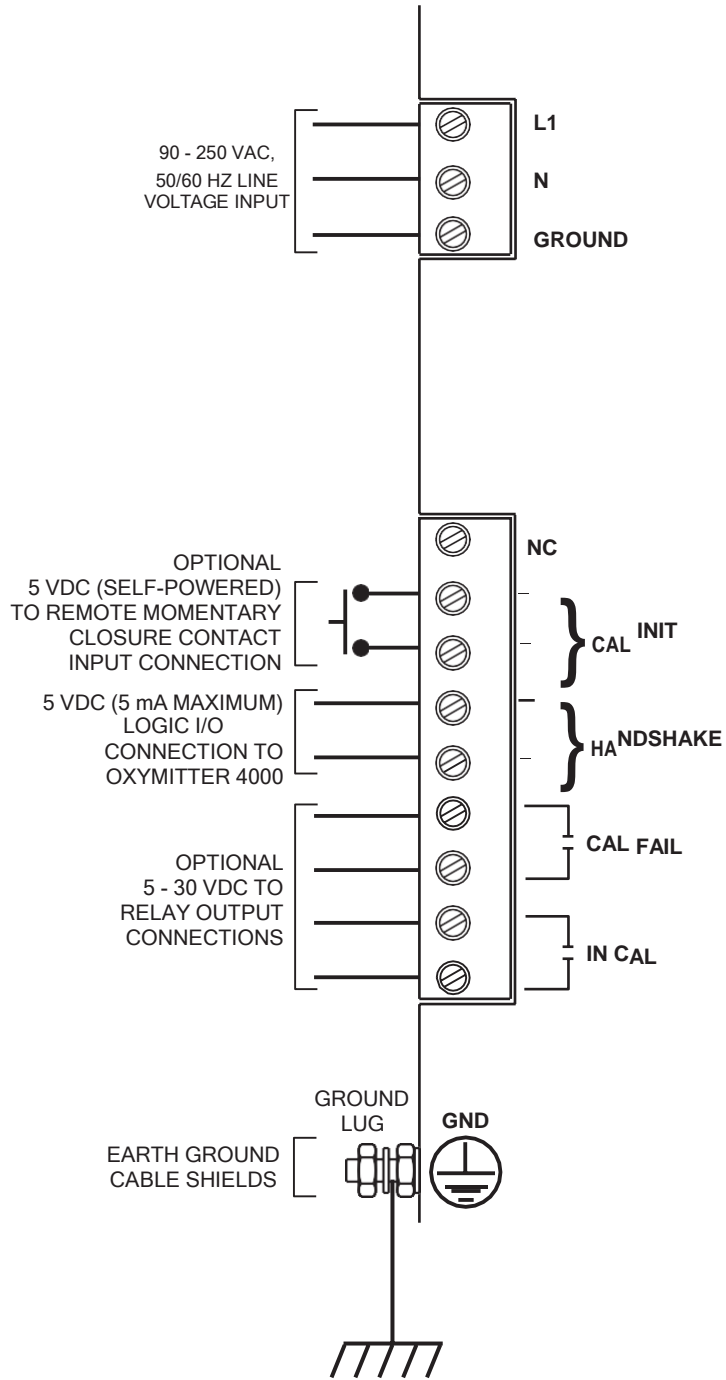

37740003

**CIRCUIT BOARD  
REPLACEMENT**

Perform the following procedure to replace circuit board (5, Figure 4-1).

**⚠ WARNING**

Disconnect and lock out power before working on any electrical components.

1. Remove the SPS 4001B chassis from the enclosure according to the instructions in "Remove/Install Chassis".
2. Refer to Figure 4-2. Disconnect wiring from the circuit board.
3. Disconnect the solenoid and pressure switch connectors.
4. Refer to Figure 4-1. Remove circuit board (5) from chassis (24).
5. Connect mating wires to solenoid (14 or 15) and pressure switch (16). Lo Gas solenoid connects to J6, Hi Gas solenoid to J5, and pressure switch to J3.
6. Install the replacement circuit board (5) on chassis (24).
7. Reinstall field wiring to circuit board.
8. Install the SPS 4001B chassis in the enclosure according to the instructions in "Remove/Install Chassis".

**SOLENOID  
REPLACEMENT**

Use this procedure to replace the calibration gas 1 (Hi Gas) solenoid (14, Figure 4-1) or calibration gas 2 (Low Gas) solenoid (15).

**⚠ WARNING**

Disconnect and lock out power before working on any electrical components.

1. Remove the SPS 4001B chassis from the enclosure according to the instructions in "Remove/Install Chassis".
2. Unplug solenoid (14 or 15) lead wire.
3. Remove the top nut of solenoid (14 or 15) securing the coil assembly and washer to the base. Remove the coil assembly, including the leads, and washer. Use a 13/16 in. wrench to loosen and remove the solenoid base.

**⚠ CAUTION**

When installing a solenoid, do not overtighten. Damage to the solenoid may occur.

4. Install the new solenoid base. Be careful not to overtighten. Install the new washer and coil assembly and secure with the top nut.
5. Connect the solenoid lead wire to solenoid (14 or 15).
6. Install the SPS 4001B chassis in the enclosure according to the instructions in "Remove/Install Chassis".

## PRESSURE SWITCH REPLACEMENT

Use the following procedure to replace pressure switch (16, Figure 4-1).

1. Remove the SPS 4001B chassis from the enclosure according to the instructions in "Remove/Install Chassis".
2. Remove lead wire terminals from pressure switch (16).
3. Use a 1-1/16 in. 6-point socket to loosen and remove switch (16).

### ⚠ CAUTION

When installing the pressure switch, do not overtighten. Damage to the solenoid may occur.

4. Install new pressure switch (16). Be careful not to overtighten. Connect the leads to the pressure switch terminals. Polarity does not matter.
5. Install the SPS 4001B chassis in the enclosure according to the instructions "Remove/Install Chassis".

## CHECK VALVE REPLACEMENT

The check valve (Figure 1-3) may stick or become plugged over time. Replace when necessary. If condensation deposits are noted upon removal, consider insulating the check valve.

## PRESSURE REGULATOR MAINTENANCE

The reference air pressure regulator (22, Figure 4-1) is factory set to 25 psi (172 kPa). If necessary, use the knob on top of the pressure regulator to readjust the pressure setting. Refer to "Remove/Install Chassis" to access the pressure regulator for adjustment.

## FLOW METER ADJUSTMENTS

### Calibration Gas Flow Meter

Calibration gas flow meter (26, Figure 4-1) regulates the calibration gas flow. The flow meter requires readjustment only after installing a new diffusion element on the Oxymitter 4000 probe. Adjusting the flow meter at any other time can pressurize the cell and bias the calibration.

In applications with a heavy dust loading, the O<sub>2</sub> probe diffusion element may become plugged over time, causing a slower speed of response. The best way to detect a plugged diffusion element is to note the time it takes the Oxymitter 4000 to return to the normal process reading after the last calibration gas is removed and the calibration gas line is blocked off. A plugged element also can be indicated by a slightly lower reading on the flow meter.

Change the diffusion element when the calibration gas flow meter reads slightly lower during calibration or when the response time to the process flue gases becomes very slow. Each time the diffusion element is changed, reset the calibration gas flow meter and calibrate the Oxymitter 4000. For more information on changing the diffusion element, refer to the instruction manual for the Oxymitter 4000 in use.

### Reference Air Flow Meter

Reference air flow meter (25) regulates the reference air. Adjust the flow with the knob on the bottom of the reference air flow meter when necessary.

## CLEANING

The SPS 4001B should be cleaned with only non-abrasive and non-hazardous cleaners.





# Section 5 Troubleshooting

---

Overview .....	page 5-1
SPS 4001B Troubleshooting .....	page 5-1

---

## OVERVIEW

This section describes the SPS 4001B troubleshooting procedures. Additional troubleshooting information can be found in the Oxymitter 4000 Oxygen Transmitter Instruction Manual.

**⚠ WARNING**

Secure equipment cover and ground leads after troubleshooting. Failure to secure covers and ground leads could result in serious injury or death.

## SPS 4001B TROUBLESHOOTING

Use the CAL FAIL and IN CAL relay outputs to identify possible SPS faults.

### CAL FAIL

If a calibration was not successfully completed, the SPS 4001B sends a CAL FAIL contact indication to the control room. To determine if the SPS 4001B caused the failed calibration, go to the Oxymitter 4000 site to view the keypad. Or, access the HART/AMS menus. For more information on HART/AMS, refer to the HART/AMS section in the Oxymitter 4000 Oxygen Transmitter Instruction Manual.

If no alarms are indicated on the keypad, LOI, or in the HART/AMS STATUS submenu, the calibration did not fail because of an Oxymitter 4000 fault. Therefore, a calibration gas flow problem occurred. Refer to Table 5-1 or Figure 5-1 to troubleshoot the SPS 4001B.

If the LAST CAL FAILED alarm is indicated on the keypad, LOI, or in the HART/AMS STATUS submenu, the failure is due to either a bad Oxymitter 4000 cell or a calibration gas flow problem.

1. Verify your calibration setup per "Gas Connections" in Section 2, Installation; Section 3, Operation; and "Flow Meter Adjustments" in Section 4, Maintenance and Service.

2. Perform another calibration and monitor the process. If the calibration fails before both calibration gases finish sequencing, a gas flow problem exists. Refer to Table 5-1 or Figure 5-1 to troubleshoot the SPS 4001B.

If the calibration setup is correct and the Oxymitter 4000 indicates an invalid slope fault (fault 12) before the gases are purged and a last calibration failed fault (fault 14) after the gases are purged, replace the Oxymitter 4000 cell per the Oxymitter 4000 Oxygen Transmitter Instruction Manual.

**Relay Failure**

If a semi-automatic or manual calibration is being performed but no 5 - 30 VDC relay output contact (IN CAL or CAL FAIL) is being received by the control room, the circuit board relays are malfunctioning. Replace the circuit board per "Circuit Board Replacement" in Section 4, Maintenance and Service.

**NOTE**

If the unit is performing frequent auto-calibrations, investigate at the Oxymitter 4000 site or using HART/AMS. This condition may indicate an aging cell in the Oxymitter 4000.

Table 5-1. SPS 4001B Fault Finding

No calibration gas flow Probable Cause	Recommended Corrective Action
Improper wire connections, loose connections, or damaged wiring	Properly connect wiring or secure loose wiring connections; replace damaged wiring if necessary.
Oxymitter 4000 logic I/O not set for calibration handshaking with SPS 4001B	Set logic I/O to mode 8 or 9 via HART/AMS.
Clogged calibration gas line between tank and manifold	Replace clogged calibration gas line.
Flow meter knob not turned counterclockwise to allow flow	Turn calibration gas flow meter knob counter-clockwise to allow calibration gas to flow.
Clogged calibration gas line between manifold and calibration gas flow meter	Replace clogged calibration gas line.
Blown fuse	Replace fuse per "Fuse Replacement", Section 4, Maintenance and Service
Circuit board not sending signals	Replace circuit board per "Circuit Board Replacement", Section 4, Maintenance and Service.
Clogged check valve	Replace check valve per "Check Valve Replacement", Section 4, Maintenance and Service.
Clogged calibration gas line between calibration gas flow meter and check valve	Replace calibration gas line.
Clogged calibration gas flow meter	Replace calibration gas flow meter.
Solenoid failure	Replace solenoid per "Solenoid Replacement", Section 4, Maintenance and Service.
Pressure switch failure	Replace pressure switch per "Pressure Switch Replacement", Section 4, Maintenance and Service.

Figure 5-1. SPS 4001B Troubleshooting Flowchart (Sheet 1 of 2)

**SYMPTOM — NO CALIBRATION GAS FLOW**

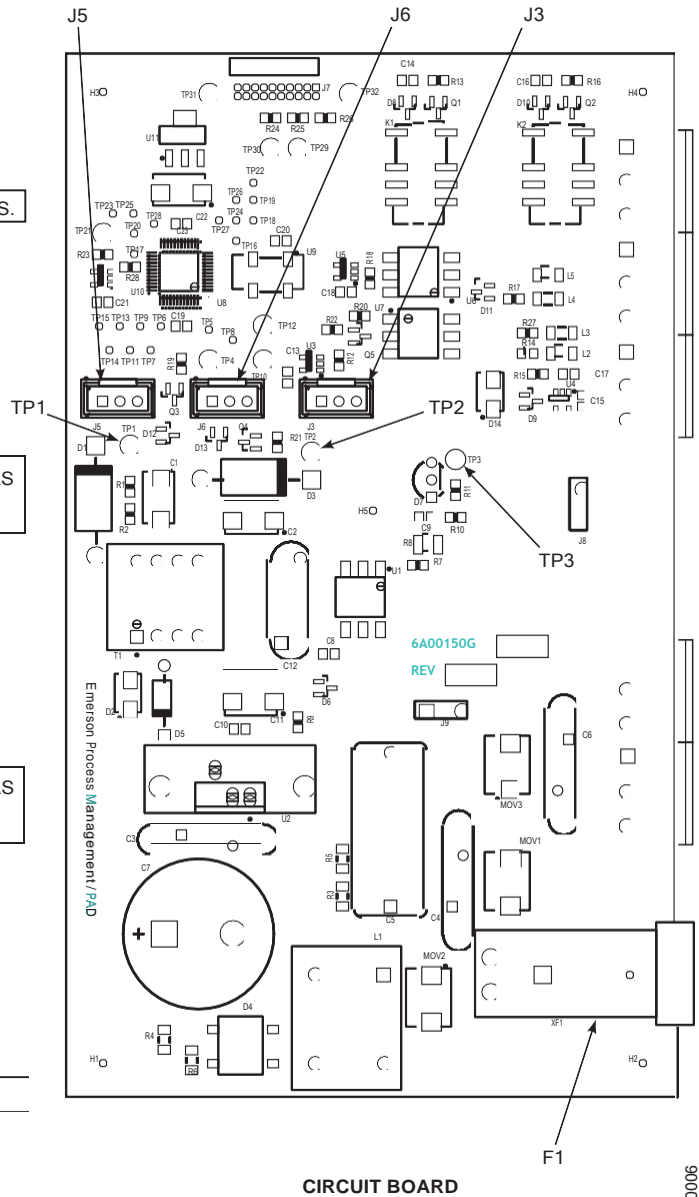
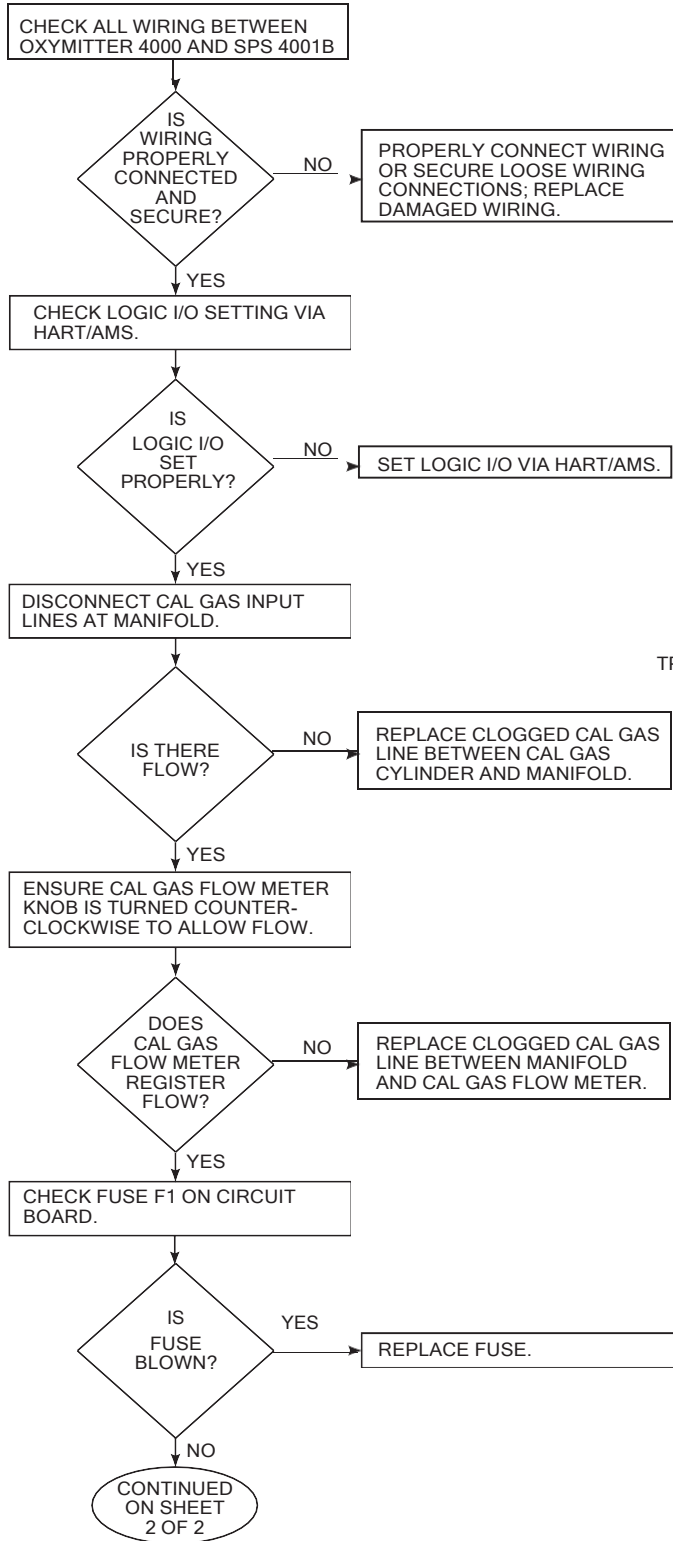

37740006

# SPS 4001B

Figure 5-1. SPS 4001B Troubleshooting Flowchart (Sheet 2 of 2)

**SYMPTOM — NO CALIBRATION GAS FLOW (CONTINUED)**

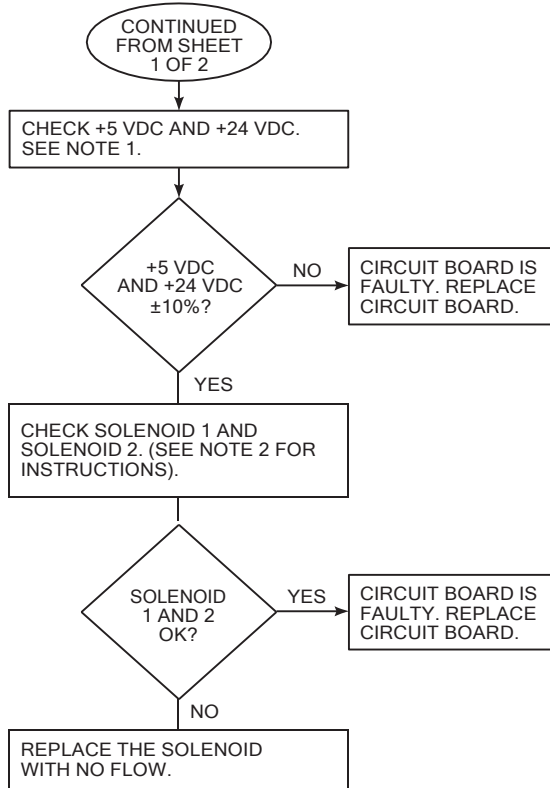

NOTE 1: +5 VDC IS ON TP2; TP3 IS RETURN.  
 +24 VDC IS ON TP1; TP3 IS RETURN.

NOTE 2: UNPLUG J5. CONNECT SOLENOID PINS 1 AND 3 TO +24 VDC ON TP1. TP3 IS RETURN.

REPEAT FOR SOLENOID 2 CONNECTED TO J6.

**ADDITIONAL INFORMATION**

IF FLOW STARTS THEN STOPS AFTER SEVERAL SECONDS, THE PRESSURE SWITCH MAY BE BAD. TO TEST PRESSURE SWITCH, UNPLUG FROM J3 AND INSTALL JUMPER ACROSS J3 TERMINALS. THEN, RESTART CALIBRATION. IF THIS CORRECTS THE PROBLEM, THE PRESSURE SWITCH IS BAD; REPLACE IT.

37740009

---

## Section 6 Replacement Parts

---

SPS 4001B .....	page 6-2
Calibration Components .....	page 6-3

---

## SPS 4001B

Figure 6-1. Replacement Parts

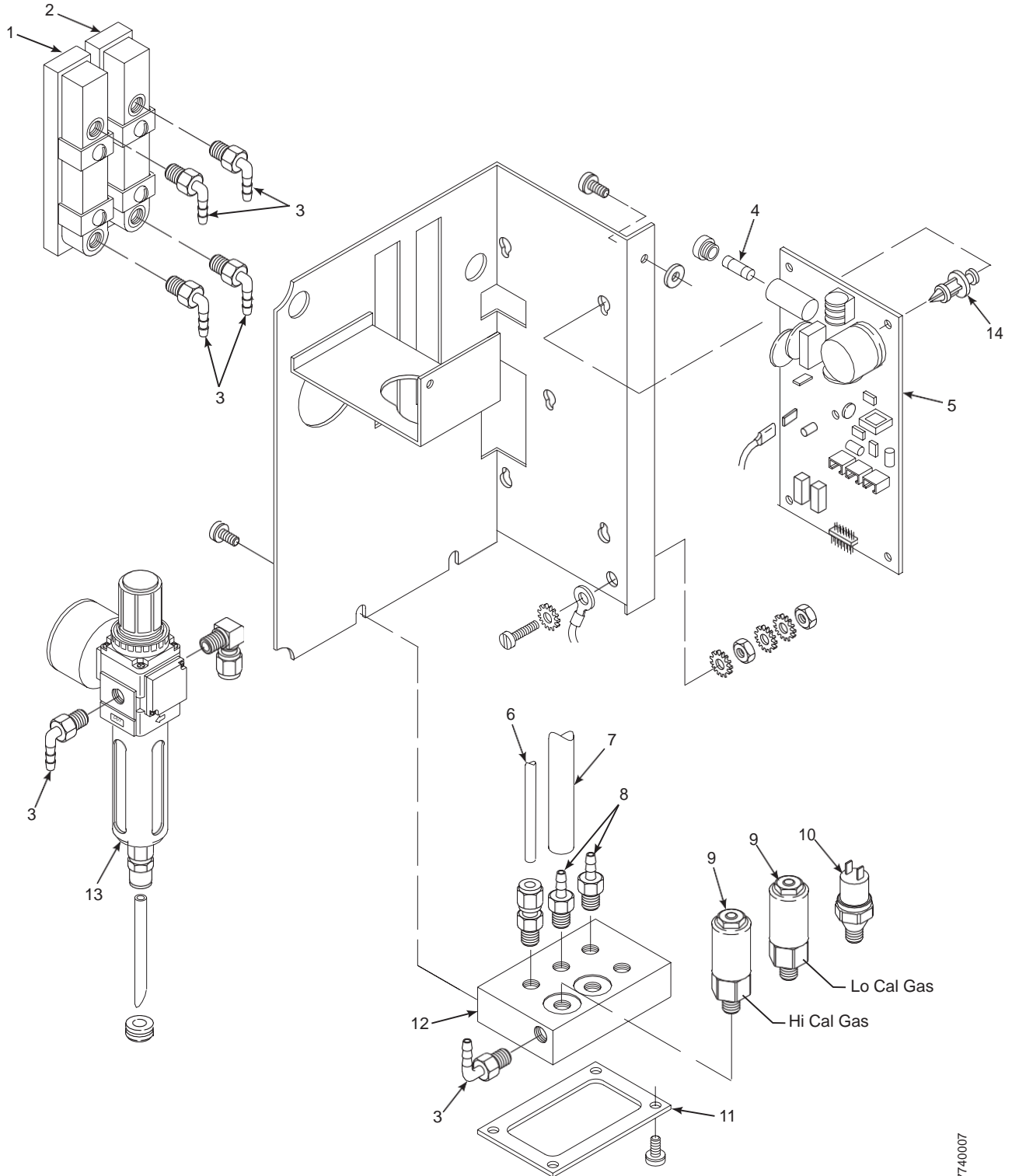

Index No.	Part Number	Description
1	771B635H02	Flow Meter Assembly, Reference Air
2	771B635H01	Flow Meter Assembly, Calibration Gas
3	1A98808H03	Fitting, 90 Degree, Nylon, 1/8 NPT
4	1A97913H22	Fuse, 1.6A, 260V, 5 x 20 mm, Fast Acting
5	6A00150G01	Circuit Board
6	6292A80H01	Hose, High Pressure, Impolene
7	1A97902H01	Hose, Low Pressure, Buna N with Overbraid
8	1A98808H02	Fitting, Straight, Nylon, 1/8 NPT
9	1A97905H01	Solenoid Valve
10	7305A67H01	Pressure Switch
11	6P00151H01	Manifold Gasket
12	6P00150H01	Manifold
13	1A99094H02	Reference Air Pressure Regulator
14	1A99785H01	Standoff, Nylon
	6292A97H03	Check Valve (not shown, see Figure 1-3)
	1A99763H01	Mounting Foot, Enclosure (not shown, see Figure 2-1)

## CALIBRATION COMPONENTS

Fig. No.	Part Number	Description
1-3	1A99119G01	Calibration Gas Bottles - 0.4% and 8% O <sub>2</sub> , balance nitrogen - 550 liters each*
1-3	1A99119G02	Two flow regulators (for calibration gas bottles)
1-3	1A99119G03	Bottle Rack

\* Calibration gas bottles cannot be shipped via airfreight.





---

# Appendix A      Safety Data

---



<b>Safety Instructions .....</b>	<b>page A-2</b>
----------------------------------	-----------------

---

## SAFETY INSTRUCTIONS

**IMPORTANT****SAFETY INSTRUCTIONS FOR THE WIRING  
AND INSTALLATION OF THIS APPARATUS**



The following safety instructions apply specifically to all EU member states. They should be strictly adhered to in order to assure compliance with the Low Voltage Directive. Non-EU states should also comply with the following unless superseded by local or National Standards.

1. Adequate earth connections should be made to all earthing points, internal and external, where provided.
2. After installation or troubleshooting, all safety covers and safety grounds must be replaced. The integrity of all earth terminals must be maintained at all times.
3. Mains supply cords should comply with the requirements of IEC227 or IEC245.
4. All wiring shall be suitable for use in an ambient temperature of greater than 75°C.
5. All cable glands used should be of such internal dimensions as to provide adequate cable anchorage.
6. To ensure safe operation of this equipment, connection to the mains supply should only be made through a circuit breaker which will disconnect all circuits carrying conductors during a fault situation. The circuit breaker may also include a mechanically operated isolating switch. If not, then another means of disconnecting the equipment from the supply must be provided and clearly marked as such. Circuit breakers or switches must comply with a recognized standard such as IEC947. All wiring must conform with any local standards.
7. Where equipment or covers are marked with the symbol to the right, hazardous voltages are likely to be present beneath. These covers should only be removed when power is removed from the equipment - and then only by trained service personnel. 
8. Where equipment or covers are marked with the symbol to the right, there is a danger from hot surfaces beneath. These covers should only be removed by trained service personnel when power is removed from the equipment. Certain surfaces may remain hot to the touch. 
9. Where equipment or covers are marked with the symbol to the right, refer to the Operator Manual for instructions. 
10. All graphical symbols used in this product are from one or more of the following standards: EN61010-1, IEC417, and ISO3864.
11. Where equipment or labels are marked "Do Not Open While Energized" or similar, there is a danger of ignition in areas where an explosive atmosphere is present. This equipment should only be opened when power is removed and adequate time as specified on the label or in the instruction manual has been allowed for the equipment to cool down - and then only by trained service personnel.

## **DŮLEŽITÉ**

### **Bezpečnostní pokyny pro zapojení a instalaci zařízení**



**Následující bezpečnostní pokyny se speciálně vztahují na všechny členské státy EU. Pokyny by měly být přísně dodržovány, aby se zajistilo splnění Směrnice o nízkém napětí. Pokud nejsou pokyny nahrazeny místními či národními normami, měly by je dodržovat i nečlenské státy EU.**

1. U všech zemnicích bodů, interních a externích, by mělo být vytvořeno odpovídající uzemnění.
2. Po instalaci nebo odstranění problémů musí být vyměněny všechny bezpečnostní kryty a uzemnění. Vždy musí být zajištěna integrita všech zemnicích svorek.
3. Síťové kabely by měly odpovídat požadavkům normy IEC227 nebo IEC245.
4. Všechna zapojení by měla být vhodná pro použití při vnějších teplotách nad 75 °C.
5. Všechna použitá kabelová hrdla by měla mít takové vnitřní rozměry, aby zajistila odpovídající zakotvení kabelu.
6. Správnou činnost zařízení zajistíte, vytvoříte-li připojení k napájecímu zdroji pouze přes jistič, který v případě poruchy odpojí všechny obvody s konduktory. Jistič může také obsahovat mechanický odpojovač. Pokud ho neobsahuje, musí být zajištěn a jasně označen jiný způsob odpojení zařízení od zdroje. Jističe nebo přepínače musí odpovídat uznávaným normám, např. IEC947. Všechna zapojení musí odpovídat místním normám.
7. Je-li zařízení nebo kryt označen symbolem na pravé straně, pravděpodobně se uvnitř nachází nebezpečné napětí. Tyto kryty by měly být sejmuty pouze po odpojení zařízení od zdroje - a to pouze kvalifikovaným zaměstnancem. 
8. Je-li zařízení nebo kryt označen symbolem na pravé straně, povrch zařízení může být velmi horký. Tyto kryty by měly být sejmuty pouze kvalifikovaným zaměstnancem po odpojení zařízení od zdroje. Některé povrchy mohou být stále horké. 
9. Je-li zařízení nebo kryt označen symbolem na pravé straně, přečtěte si nejprve instrukce v návodu k obsluze. 
10. Všechny grafické symboly používané u výrobku pocházejí z následujících norem: EN61010-1, IEC417 a ISO3864.
11. Pokud je zařízení nebo štítky označeno varováním „Je-li zařízení pod napětím, neotvírejte jej“ či podobným, může dojít ve výbušném prostředí ke vznícení. Zařízení lze otevřít pouze po jeho odpojení od zdroje a ponechání dostatečného času na vychladnutí, jak je uvedeno na štítku nebo v návodu k obsluze - a to pouze kvalifikovaným zaměstnancem.

## **VIGTIGT**

### **Sikkerhedsinstruktion for tilslutning og installation af dette udstyr.**



**Følgende sikkerhedsinstruktioner gælder specifikt i alle EU-medlemslande. Instruktionerne skal nøje følges for overholdelse af Lavspændingsdirektivet og bør også følges i ikke EU-lande medmindre andet er specificeret af lokale eller nationale standarder.**

1. Passende jordforbindelser skal tilsluttes alle jordklemmer, interne og eksterne, hvor disse forefindes.
2. Efter installation eller fejlfinding skal alle sikkerhedsdæksler og jordforbindelser reetableres.
3. Forsyningskabler skal opfylde krav specificeret i IEC227 eller IEC245.
4. Alle ledningstilslutninger skal være konstrueret til omgivelsestemperatur højere end 75°C.
5. Alle benyttede kabelforskrutninger skal have en intern dimension, så passende kabelafastning kan etableres.
6. For opnåelse af sikker drift og betjening skal der skabes beskyttelse mod indirekte berøring gennem afbryder (min. 10A), som vil afbryde alle kredsløb med elektriske ledere i fejlsituation. Afbryderen skal indholde en mekanisk betjent kontakt. Hvis ikke skal anden form for afbryder mellem forsyning og udstyr benyttes og mærkes som sådan. Afbrydere eller kontakter skal overholde en kendt standard som IEC947.
7. Hvor udstyr eller dæksler er mærket med dette symbol, er farlige spændinger normalt forekommende bagved. Disse dæksler bør kun afmonteres, når forsyningsspændingen er frakoblet - og da kun af instrueret servicepersonale. 
8. Hvor udstyr eller dæksler er mærket med dette symbol, forefindes meget varme overflader bagved. Disse dæksler bør kun afmonteres af instrueret servicepersonale, når forsyningsspænding er frakoblet. Visse overflader vil stadig være for varme at berøre i op til 45 minutter efter frakobling. 
9. Hvor udstyr eller dæksler er mærket med dette symbol, se da i betjeningsmanual for instruktion. 
10. Alle benyttede grafiske symboler i dette udstyr findes i én eller flere af følgende standarder:- EN61010-1, IEC417 & ISO3864.
11. Når udstyr eller etiketter er mærket "Må ikke åbnes, mens udstyret tilføres strøm" eller lignende, er der fare for antændelse i områder, hvor der er en eksplosiv atmosfære. Dette udstyr må kun åbnes, når strømkilden er fjernet, og der er gået tilstrækkelig tid til, at udstyret er kølet ned. Den nødvendige tid hertil er angivet på etiketten eller i brugervejledningen. Udstyret må kun åbnes af en faglært person.

## **BELANGRIJK**

### **Veiligheidsvoorschriften voor de aansluiting en installatie van dit toestel.**

**De hierna volgende veiligheidsvoorschriften zijn vooral bedoeld voor de EU lidstaten. Hier moet aan gehouden worden om de onderworpenheid aan de Laag Spannings Richtlijn (Low Voltage Directive) te verzekeren. Niet EU staten zouden deze richtlijnen moeten volgen tenzij zij reeds achterhaald zouden zijn door plaatselijke of nationale voorschriften.**

1. Degelijke aardingsaansluitingen moeten gemaakt worden naar alle voorziene aardpunten, intern en extern.
2. Na installatie of controle moeten alle veiligheidsdeksels en -aarding terug geplaatst worden. Ten alle tijde moet de betrouwbaarheid van de aarding behouden blijven.
3. Voedingskabels moeten onderworpen zijn aan de IEC227 of de IEC245 voorschriften.
4. Alle bekabeling moet geschikt zijn voor het gebruik in omgevingstemperaturen, hoger dan 75°C.
5. Alle wartels moeten zo gedimensioneerd zijn dat een degelijke kabel bevestiging verzekerd is.
6. Om de veilige werking van dit toestel te verzekeren, moet de voeding door een stroomonderbreker gevoerd worden (min 10A) welke alle draden van de voeding moet onderbreken. De stroomonderbreker mag een mechanische schakelaar bevatten. Zoniet moet een andere mogelijkheid bestaan om de voedingsspanning van het toestel te halen en ook duidelijk zo zijn aangegeven. Stroomonderbrekers of schakelaars moeten onderworpen zijn aan een erkende standaard zoals IEC947.
7. Waar toestellen of deksels aangegeven staan met het symbool is er meestal hoogspanning aanwezig. Deze deksels mogen enkel verwijderd worden nadat de voedingsspanning werd afgelegd en enkel door getraind onderhoudspersoneel. 
8. Waar toestellen of deksels aangegeven staan met het symbool is er gevaar voor hete oppervlakken. Deze deksels mogen enkel verwijderd worden door getraind onderhoudspersoneel nadat de voedingsspanning verwijderd werd. Sommige oppervlakken kunnen 45 minuten later nog steeds heet aanvoelen. 
9. Waar toestellen of deksels aangegeven staan met het symbool gelieve het handboek te raadplegen. 
10. Alle grafische symbolen gebruikt in dit produkt, zijn afkomstig uit een of meer van devolgende standaards: EN61010-1, IEC417 en ISO3864.
11. Op plaatsen waar uitrusting of etiketten zijn voorzien van een melding als "Niet openen bij aanwezigheid van spanning" bestaat er brandgevaar in omgevingen waar een explosieve atmosfeer aanwezig is. Deze uitrusting mag uitsluitend worden geopend wanneer het niet meer onder spanning staat en de uitrusting gedurende de voorgeschreven tijd op het etiket of in de handleiding is afgekoeld - en dan uitsluitend door voldoende opgeleid onderhoudspersoneel.

## **BELANGRIJK**

### **Veiligheidsinstructies voor de bedrading en installatie van dit apparaat.**

**Voor alle EU lidstaten zijn de volgende veiligheidsinstructies van toepassing. Om aan de geldende richtlijnen voor laagspanning te voldoen dient men zich hieraan strikt te houden. Ook niet EU lidstaten dienen zich aan het volgende te houden, tenzij de lokale wetgeving anders voorschrijft.**

1. Alle voorziene interne- en externe aardaansluitingen dienen op adequate wijze aangesloten te worden.
2. Na installatie, onderhouds- of reparatie werkzaamheden dienen alle beschermdeksels /kappen en aardingen om reden van veiligheid weer aangebracht te worden.
3. Voedingskabels dienen te voldoen aan de vereisten van de normen IEC 227 of IEC 245.
4. Alle bedrading dient geschikt te zijn voor gebruik bij een omgevings temperatuur boven 75°C.
5. Alle gebruikte kabelwartels dienen dusdanige inwendige afmetingen te hebben dat een adequate verankering van de kabel wordt verkregen.
6. Om een veilige werking van de apparatuur te waarborgen dient de voeding uitsluitend plaats te vinden via een meerpolige automatische zekering (min.10A) die alle spanningvoerende geleiders verbreekt indien een foutconditie optreedt. Deze automatische zekering mag ook voorzien zijn van een mechanisch bediende schakelaar. Bij het ontbreken van deze voorziening dient een andere als zodanig duidelijk aangegeven mogelijkheid aanwezig te zijn om de spanning van de apparatuur af te schakelen. Zekeringen en schakelaars dienen te voldoen aan een erkende standaard zoals IEC 947.
7. Waar de apparatuur of de beschermdeksels/kappen gemarkeerd zijn met het volgende symbool, kunnen zich hieronder spanning voerende delen bevinden die gevaar op kunnen leveren. Deze beschermdeksels/kappen mogen uitsluitend verwijderd worden door getraind personeel als de spanning is afgeschakeld. 
8. Waar de apparatuur of de beschermdeksels/kappen gemarkeerd zijn met het volgende symbool, kunnen zich hieronder hete oppervlakken of onderdelen bevinden. Bepaalde delen kunnen mogelijk na 45 min. nog te heet zijn om aan te raken. 
9. Waar de apparatuur of de beschermdeksels/kappen gemarkeerd zijn met het volgende symbool, dient men de bedieningshandleiding te raadplegen. 
10. Alle grafische symbolen gebruikt bij dit produkt zijn volgens een of meer van de volgende standaarden: EN 61010-1, IEC 417 & ISO 3864.
11. Op plaatsen waar uitrusting of etiketten zijn voorzien van een melding als "Niet openen bij aanwezigheid van spanning" bestaat er brandgevaar in omgevingen waar een explosieve atmosfeer aanwezig is. Deze uitrusting mag uitsluitend worden geopend wanneer het niet meer onder spanning staat en de uitrusting gedurende de voorgeschreven tijd op het etiket of in de handleiding is afgekoeld - en dan uitsluitend door voldoende opgeleid onderhoudspersoneel.

## **WICHTIG**

### **Sicherheitshinweise für den Anschluß und die Installation dieser Geräte.**

**Die folgenden Sicherheitshinweise sind in allen Mitgliederstaaten der europäischen Gemeinschaft gültig. Sie müssen strikt eingehalten werden, um der Niederspannungsrichtlinie zu genügen.**

**Nichtmitgliedsstaaten der europäischen Gemeinschaft sollten die national gültigen Normen und Richtlinien einhalten.**



1. Alle intern und extern vorgesehenen Erdungen der Geräte müssen ausgeführt werden.
2. Nach Installation, Reparatur oder sonstigen Eingriffen in das Gerät müssen alle Sicherheitsabdeckungen und Erdungen wieder installiert werden. Die Funktion aller Erdverbindungen darf zu keinem Zeitpunkt gestört sein.
3. Die Netzspannungsversorgung muß den Anforderungen der IEC227 oder IEC245 genügen.
4. Alle Verdrahtungen sollten mindestens bis 75°C ihre Funktion dauerhaft erfüllen.
5. Alle Kabeldurchführungen und Kabelverschraubungen sollten in Ihrer Dimensionierung so gewählt werden, daß diese eine sichere Verkabelung des Gerätes ermöglichen.
6. Um eine sichere Funktion des Gerätes zu gewährleisten, muß die Spannungsversorgung über mindestens 10 A abgesichert sein. Im Fehlerfall muß dadurch gewährleistet sein, daß die Spannungsversorgung zum Gerät bzw. zu den Geräten unterbrochen wird. Ein mechanischer Schutzschalter kann in dieses System integriert werden. Falls eine derartige Vorrichtung nicht vorhanden ist, muß eine andere Möglichkeit zur Unterbrechung der Spannungszufuhr gewährleistet werden mit Hinweisen deutlich gekennzeichnet werden. Ein solcher Mechanismus zur Spannungsunterbrechung muß mit den Normen und Richtlinien für die allgemeine Installation von Elektrogeräten, wie zum Beispiel der IEC947, übereinstimmen.
7. Mit dem Symbol sind Geräte oder Abdeckungen gekennzeichnet, die eine gefährliche (Netzspannung) Spannung führen. Die Abdeckungen dürfen nur entfernt werden, wenn die Versorgungsspannung unterbrochen wurde. Nur geschultes Personal darf an diesen Geräten Arbeiten ausführen.
8. Mit dem Symbol sind Geräte oder Abdeckungen gekennzeichnet, in bzw. unter denen heiße Teile vorhanden sind. Die Abdeckungen dürfen nur entfernt werden, wenn die Versorgungsspannung unterbrochen wurde. Nur geschultes Personal darf an diesen Geräten Arbeiten ausführen. Bis 45 Minuten nach dem Unterbrechen der Netzzufuhr können derartig Teile noch über eine erhöhte Temperatur verfügen.
9. Mit dem Symbol sind Geräte oder Abdeckungen gekennzeichnet, bei denen vor dem Eingriff die entsprechenden Kapitel im Handbuch sorgfältig durchgelesen werden müssen.
10. Alle in diesem Gerät verwendeten graphischen Symbole entspringen einem oder mehreren der nachfolgend aufgeführten Standards: EN61010-1, IEC417 & ISO3864.
11. Wenn Geräte oder Etiketten mit dem Hinweis "Nicht unter Spannung öffnen" oder ähnlichen Hinweisen versehen sind, besteht in explosionsgefährdeten Umgebungen Entzündungsgefahr. Das Gerät darf nur geöffnet werden, wenn es nicht ans Stromnetz angeschlossen und entsprechend der Zeitangaben auf dem Etikett bzw. in der Betriebsanleitung ausreichend abgekühlt ist. Das Gerät darf nur von geschultem Service-Personal geöffnet werden.



## ΣΗΜΑΝΤΙΚΟ

**Οδηγισ ασφαλειασ για την καλωδιωση και εγκατασταση της συσκευης**

**Οι ακόλουθες οδηγίες ασφαλείας εφαρμόζονται ειδικά για όλες τις χώρες μέλη της Ευρωπαϊκής Κοινότητας. Θα πρέπει να ακολουθούνται αυστηρά ώστε να εξασφαλιστεί η συμβατότητα με τις οδηγίες για τη Χαμηλή Τάση. Χώρες που δεν είναι μέλη της Ευρωπαϊκής Κοινότητας θα πρέπει επίσης να ακολουθούν τις οδηγίες, εκτός εάν αυτές αντικαθίστανται από τα Τοπικά ή Εθνικά πρότυπα.**



1. Επαρκείς συνδέσεις γείωσης θα πρέπει να γίνονται σε όλα τα σημεία γείωσης, εσωτερικά και εξωτερικά, όπου υπάρχουν.
2. Μετά την εγκατάσταση ή την αντιμετώπιση σφαλμάτων, όλα τα καλύμματα ασφαλείας και οι γειώσεις ασφαλείας πρέπει να επανεγκαθίστανται. Η καλή κατάσταση όλων των ακροδεκτών γείωσης πρέπει να συντηρείται διαρκώς.
3. Τα καλώδια τροφοδοσίας πρέπει να πληρούν τις απαιτήσεις των IEC227 ή IEC245.
4. Όλες οι καλωδιώσεις θα πρέπει να είναι κατάλληλες για χρήση σε θερμοκρασία χώρου υψηλότερη από 75°C.
5. Όλοι οι στυπιοθλίπτες θα πρέπει να είναι τέτοιων εσωτερικών διαστάσεων, ώστε να παρέχουν επαρκή στερέωση των καλωδίων.
6. Για τη διασφάλιση ασφαλούς λειτουργίας αυτής της συσκευής, η σύνδεση τροφοδοσίας θα πρέπει να γίνεται μόνο μέσω ασφαλειοδιακόπτη, ο οποίος θα αποσυνδέει όλους τους ηλεκτροφόρους αγωγούς των κυκλωμάτων, στη διάρκεια κατάστασης σφάλματος. Ο ασφαλειοδιακόπτης μπορεί επίσης να περιλαμβάνει μηχανικό διακόπτη απομόνωσης. Εάν δεν περιλαμβάνει, τότε άλλα μέσα αποσύνδεσης της συσκευής από την τροφοδοσία πρέπει να παροχηθούν και να σημανθούν σαφώς ως τέτοια. Οι ασφαλειοδιακόπτες ή διακόπτες πρέπει να συμμορφώνονται με αναγνωρισμένα πρότυπα όπως το IEC947. Όλες οι καλωδιώσεις πρέπει να συμμορφώνονται με τα τοπικά πρότυπα.
7. Όπου συσκευές ή καλύμματα είναι σημασμένα με το σύμβολο που εικονίζεται δεξιά, επικίνδυνες τάσεις ενυπάρχουν κάτω από αυτά. Αυτά τα καλύμματα θα πρέπει να αφαιρούνται μόνο όταν έχει αφαιρεθεί η τροφοδοσία από τη συσκευή - και στην περίπτωση αυτή, μόνο από ειδικευμένο τεχνικό προσωπικό. 
8. Όπου συσκευές ή καλύμματα είναι σημασμένα με το σύμβολο που εικονίζεται δεξιά, υπάρχει κίνδυνος από καυτές επιφάνειες κάτω από αυτά. Τέτοια καλύμματα θα πρέπει να αφαιρούνται μόνο από ειδικευμένο τεχνικό προσωπικό, όταν έχει αφαιρεθεί η τροφοδοσία από τη συσκευή. Κάποιες επιφάνειες μπορούν να παραμένουν ζεστές στην αφή. 
9. Όπου συσκευές ή καλύμματα είναι σημασμένα με το σύμβολο που εικονίζεται δεξιά, ανατρέξτε στις οδηγίες χρήσης της συσκευής. 
10. Όλα τα γραφικά σύμβολα που χρησιμοποιούνται σε αυτό το προϊόν είναι από ένα ή περισσότερα από τα εξής πρότυπα: EN61010-1, IEC417 και ISO3864.
11. Όπου συσκευή ή ετικέτα είναι σημασμένη με την ένδειξη "Μην ανοίγετε ενώ βρίσκεται σε λειτουργία" ή άλλη παρόμοια, υπάρχει κίνδυνος ανάφλεξης σε περιοχές με εκρηκτική ατμόσφαιρα. Ο παρών εξοπλισμός πρέπει να ανοίγεται μόνο όταν είναι εκτός ρεύματος και αφού παρέλθει ο κατάλληλος χρόνος που αναγράφεται στην ετικέτα ή στο εγχειρίδιο οδηγιών ώστε να ψυχθεί και μόνο από εκπαιδευμένο προσωπικό συντήρησης.



## OLULINE TEAVE

### Juhtmestiku ja seadme paigaldamisega seotud ohutusjuhised



Alljärgnevad ohutusjuhised rakenduvad eriti kõigi Euroopa Liidu liikmesriikide suhtes. Antud juhiseid tuleb täpselt järgida, et kindlustada vastavus madalpinge direktiiviga. Euroopa Liitu mittekuuluvad riigid peavad samuti alljärgnevaid juhiseid järgima, va juhul, kui on olemas vastavad kohalikud riiklikud standardid.

1. Ettenähtud maanduspunktide, nii sisemiste kui väliste jaoks tuleb tagada nõuetekohased maaühendused.
2. Pärast paigaldamist või rikketuvastust tuleb kõik turvaümbrised ja turvamaandused uuesti oma kohale seada. Kõigis olukordades tuleb säilitada kõigi maandusklemmide terviklikkus.
3. Toitejuhtmed peavad vastama IEC227 või IEC245 nõuetele.
4. Kogu juhtmestik peab sobima kasutamiseks üle 75°C õhutemperatuuri juures.
5. Kõik juhtmetihendid peavad sisemõõtmete poolest tagama nõuetekohased kaabliühendused.
6. Seadme ohutu töötamise tagamiseks peab ühendus toiteallikaga toimuma vaid läbi automaatkorgi, mis veaolukorras lülitab välja kõik voolukandjad. Automaatkorgil võib olla ka mehhaaniliselt reguleeritav lahkliülit. Vastasel juhul peab seadme toiteallikast lahtiühendamiseks olema teine ja selgelt osutatud moodus. Automaatkorgid või -lülitid peavad vastama tunnustatud standarditele nagu nt IEC947. Kogu juhtmestik peab vastama kohalikele standarditele.
7. Seadmel või ümbristel asuv paremale osutav sümbol tähistab selle all leiduvat ohtlikku pinget. Selliste sümbolitega ümbriseid võib eemaldada vaid juhul, kui seade on toiteallikast lahti ühendatud ning ka siis ainult vastavate oskustega spetsialisti poolt. 
8. Seadmele või ümbristele märgitud paremale osutava sümboli all valitseb kuumadest pindadest tulenev oht. Nimetatud sümbolitega ümbriseid võib eemaldada vaid vastavate oskustega spetsialist, kui seade on toiteallikast lahti ühendatud. Teatud pinnad võivad puudutamise jaoks liiga kuumad olla. 
9. Seadmel või ümbristel leiduva paremale osutava sümboli korral vt juhiste jaoks Toimimisjuhendit. 
10. Kõik selle toote juures kasutatavad graafilised sümbolid lähtuvad ühest või enamast järgmistest standarditest: EN61010-1, IEC417 ja ISO3864.
11. Kui seadmele või siltidele on kirjutatud "Ärge avage voolutarbimine korral" vms, valitseb plahvatusohtlikus keskkonnas süttimise oht. Seadet võib avada ainult siis, kui toide on lahti ühendatud ning seadmel on võimaldatud sildil või kasutusjuhendis osutatud aja jooksul maha jahtuda -- ning ka sellisel juhul ainult vastavate oskustega spetsialisti poolt.

## **TÄRKEÄÄ**

**Turvallisuusohje, jota on noudatettava tämän laitteen asentamisessa ja kaapeloinnissa.**



**Seuraavat ohjeet pätevät erityisesti EU:n jäsenvaltioissa. Niitä täytyy ehdottomasti noudattaa jotta täytettäisiin EU:n matalajännittdirektiivin (Low Voltage Directive) yhteensopivuus. Myös EU:hun kuulumattomien valtioiden tulee nou-dattaa tätä ohjetta, elleivät kansalliset standardit estä sitä.**

1. Riittävät maadoituskytkennät on tehtävä kaikkiin maadoituspisteisiin, sisäisiin ja ulkoisiin.
2. Asennuksen ja vianetsinnän jälkeen on kaikki suojat ja suojamaat asennettava takaisin pai-koilleen. Maadoitusliittimen kunnollinen toiminta täytyy aina ylläpitää.
3. Jännitesyöttöjohtimien täytyy täyttää IEC227 ja IEC245 vaatimukset.
4. Kaikkien johdotuksien tulee toimia >75°C lämpötiloissa.
5. Kaikkien läpivientiholkkien sisähalkaisijan täytyy olla sellainen että kaapeli lukkiutuu kun-nolla kiinni.
6. Turvallisen toiminnan varmistamiseksi täytyy jännitesyöttö varustaa turvakytkimellä (min 10A), joka kytkee irti kaikki jännitesyöttöjohtimet vikatilanteessa. Suojaan täytyy myös sisältyä mekaaninen erotuskytkin. Jos ei, niin jännitesyöttö on pystyttävä katkaisemaan muilla keinoilla ja merkittävä siten että se tunnistetaan sellaiseksi. Turvakytkimien tai kat-kaisimien täytyy täyttää IEC947 standardin vaatimukset näkyvyydestä.
7. Mikäli laite tai kosketussuoja on merkitty tällä merkillä  on merkinnän takana tai alla hengenvaarallisen suuruinen jännite. Suojaa ei saa poistaa jänniteen ollessa kytkettynä laitteeseen ja poistamisen saa suorittaa vain alan asian-tuntija.
8. Mikäli laite tai kosketussuoja on merkitty tällä merkillä  on merkinnän takana tai alla kuuma pinta. Suojan saa poistaa vain alan asiantuntija kun jännite-syöttö on katkaistu. Tällainen pinta voi säilyä kosketuskuumana jopa 45 mi-nuuttia.
9. Mikäli laite tai kosketussuoja on merkitty tällä merkillä  katso lisäohjeita käyt-töohjekirjasta.
10. Kaikki tässä tuotteessa käytetyt graafiset symbolit ovat yhdestä tai useammasta seuraavis-ta standardeista: EN61010-1, IEC417 & ISO3864.
11. Jos laitteessa tai tarrassa on merkintä "Älä avaa, kun virta on kytketty" tai vastaava, räjähdysvaarallisissa tiloissa on syttymisen vaara. Nämä laitteet voidaan avata vain silloin, kun virta ei ole kytkettynä ja laitteen on annettu jäähtyä tarrassa tai oppaassa määritetyn ajan. Tällöinkin laitteet saa avata vain koulutettu huoltohenkilökunta.

## **IMPORTANT**

**Consignes de sécurité concernant le raccordement et l'installation de cet appareil.**



**Les consignes de sécurité ci-dessous s'adressent particulièrement à tous les états membres de la communauté européenne. Elles doivent être strictement appliquées afin de satisfaire aux directives concernant la basse tension. Les états non membres de la communauté européenne doivent également appliquer ces consignes sauf si elles sont en contradiction avec les standards locaux ou nationaux.**

1. Un raccordement adéquat à la terre doit être effectuée à chaque borne de mise à la terre, interne et externe.
2. Après installation ou dépannage, tous les capots de protection et toutes les prises de terre doivent être remis en place, toutes les prises de terre doivent être respectées en permanence.
3. Les câbles d'alimentation électrique doivent être conformes aux normes IEC227 ou IEC245.
4. Tous les raccordements doivent pouvoir supporter une température ambiante supérieure à 75°C.
5. Tous les presse-étoupes utilisés doivent avoir un diamètre interne en rapport avec les câbles afin d'assurer un serrage correct sur ces derniers.
6. Afin de garantir la sécurité du fonctionnement de cet appareil, le raccordement à l'alimentation électrique doit être réalisé exclusivement au travers d'un disjoncteur (minimum 10A.) isolant tous les conducteurs en cas d'anomalie. Ce disjoncteur doit également pouvoir être actionné manuellement, de façon mécanique. Dans le cas contraire, un autre système doit être mis en place afin de pouvoir isoler l'appareil et doit être signalisé comme tel. Disjoncteurs et interrupteurs doivent être conformes à une norme reconnue telle IEC947.
7. Lorsque les équipements ou les capots affichent le symbole suivant, cela signifie que des tensions dangereuses sont présentes. Ces capots ne doivent être démontés que lorsque l'alimentation est coupée, et uniquement par un personnel compétent. 
8. Lorsque les équipements ou les capots affichent le symbole suivant, cela signifie que des surfaces dangereusement chaudes sont présentes. Ces capots ne doivent être démontés que lorsque l'alimentation est coupée, et uniquement par un personnel compétent. Certaines surfaces peuvent rester chaudes jusqu'à 45 mn. 
9. Lorsque les équipements ou les capots affichent le symbole suivant, se reporter au manuel d'instructions. 
10. Tous les symboles graphiques utilisés dans ce produit sont conformes à un ou plusieurs des standards suivants: EN61010-1, IEC417 & ISO3864.
11. Les équipements comportant une étiquette avec la mention " Ne pas ouvrir sous tension " ou toute autre mention similaire peuvent créer un risque d'incendie dans les environnements explosifs. Ces équipements ne doivent être ouverts que lorsqu'ils sont hors tension et que la durée de refroidissement requise indiquée sur l'étiquette ou dans le manuel d'instructions s'est écoulée. En outre ils ne doivent être ouverts que par un personnel qualifié.

## **FONTOS**

### **Biztonsági előírások a készülék vezetékéhez és üzembeállításához**



**A következő biztonsági előírások kifejezetten vonatkoznak az összes EU-tagállamra. Ezeket szigorúan be kell tartani a Kisfeszültségű irányelvnek való megfelelés biztosításához. A nem EU-tagállamok szintén tartásuk be a következőket, kivéve ha a helyi és nemzeti szabványok azt másként nem írják elő.**

1. A megfelelő földelést biztosítani kell az összes rendelkezésre álló földelési ponton, legyen az belső vagy külső.
2. Az üzembeállítás vagy hibaelhárítás után az összes biztonsági burkolatot és biztonsági földvezetékét ki kell cserélni. A földelőkapcsok sértetlenségét mindig biztosítani kell.
3. A tápvezetékeknek eleget kell tenniük az IEC227 vagy IEC245 szabványokban megfogalmazott követelményeknek.
4. Az összes vezetéknek alkalmasnak kell lennie a 75 °C-nál magasabb környezeti hőmérséklet melletti használatra.
5. Az összes használt kábelvezető tömszelencének olyan belső méretűnek kell lennie, hogy biztosítsák a kábelek megfelelő lekötését.
6. A berendezés biztonságos működésének biztosításához az elektromos hálózathoz való csatlakozást csak megszakítón keresztül szabad megvalósítani, amely az összes áramot szállító vezeték bontja hibahelyzet esetén. A megszakító magában foglalhat egy mechanikusan működtethető áramtalanító kapcsolót is. Ellenkező esetben biztosítani kell a berendezés elektromos hálózatról történő lekapcsolásának más módját, és ezt világosan jelezni kell. A megszakítóknak vagy kapcsolóknak meg kell felelniük egy elismert szabványnak, például az IEC947 szabványnak. Az összes vezetéknek meg kell felelnie az összes helyi szabványnak.
7. Ha a berendezés vagy a burkolata a jobb oldalon látható szimbólummal jelzett, alatta valószínűleg veszélyes feszültség van jelen. Az ilyen burkolat csak a berendezés áramtalanítása után távolítható el - és csak képzett szervizszakember végezheti el. 
8. Ha a berendezés vagy a burkolata a jobb oldalon látható szimbólummal jelzett, fenn áll a veszélye, hogy alatta forró felületek találhatók. Az ilyen burkolatot csak képzett szervizszakember távolíthatja el a berendezés áramtalanítása után. Bizonyos felületek érintésre forróak maradhatnak. 
9. Ha a berendezés vagy a burkolata a jobb oldalon látható szimbólummal jelzett, tekintse meg az Üzemeltetési útmutató arra vonatkozó utasításait. 
10. A terméken használt grafikus szimbólumok a következő szabványok legalább egyikéből származnak: EN61010-1, IEC417 és ISO3864.
11. Ha a berendezésen vagy a címkén a „Ne nyissa ki bekapcsolt állapotban” vagy hasonló felhívás szerepel, robbanásveszélyes környezetben fennáll a gyulladás veszélye. Ez a berendezés csak áramtalanítás után nyitható ki, a címkén vagy a kezelési útmutatóban szereplő, a berendezés lehűlését biztosító megfelelő idői ráhagyás után - és csak képzett szervizszakember végezheti el.

## **IMPORTANTE**

### **Norme di sicurezza per il cablaggio e l'installazione dello strumento.**



**Le seguenti norme di sicurezza si applicano specificatamente agli stati membri dell'Unione Europea, la cui stretta osservanza è richiesta per garantire conformità alla Direttiva del Basso Voltaggio. Esse si applicano anche agli stati non appartenenti all'Unione Europea, salvo quanto disposto dalle vigenti normative locali o nazionali.**

1. Collegamenti di terra idonei devono essere eseguiti per tutti i punti di messa a terra interni ed esterni, dove previsti.
2. Dopo l'installazione o la localizzazione dei guasti, assicurarsi che tutti i coperchi di protezione siano stati collocati e le messa a terra siano collegate. L'integrità di ciascun morsetto di terra deve essere costantemente garantita.
3. I cavi di alimentazione della rete devono essere secondo disposizioni IEC227 o IEC245.
4. L'intero impianto elettrico deve essere adatto per uso in ambiente con temperature superiore a 75°C.
5. Le dimensioni di tutti i connettori dei cavi utilizzati devono essere tali da consentire un adeguato ancoraggio al cavo.
6. Per garantire un sicuro funzionamento dello strumento il collegamento alla rete di alimentazione principale dovrà essere eseguita tramite interruttore automatico (min.10A), in grado di disattivare tutti i conduttori di circuito in caso di guasto. Tale interruttore dovrà inoltre prevedere un sezionatore manuale o altro dispositivo di interruzione dell'alimentazione, chiaramente identificabile. Gli interruttori dovranno essere conformi agli standard riconosciuti, quali IEC947.
7. Il simbolo riportato sullo strumento o sui coperchi di protezione indica probabile presenza di elevati voltaggi. Tali coperchi di protezione devono essere rimossi esclusivamente da personale qualificato, dopo aver tolto alimentazione allo strumento. 
8. Il simbolo riportato sullo strumento o sui coperchi di protezione indica rischio di contatto con superfici ad alta temperatura. Tali coperchi di protezione devono essere rimossi esclusivamente da personale qualificato, dopo aver tolto alimentazione allo strumento. Alcune superfici possono mantenere temperature elevate per oltre 45 minuti. 
9. Se lo strumento o il coperchio di protezione riportano il simbolo, fare riferimento alle istruzioni del manuale Operatore. 
10. Tutti i simboli grafici utilizzati in questo prodotto sono previsti da uno o più dei seguenti standard: EN61010-1, IEC417 e ISO3864.
11. L'indicazione "Non aprire sotto tensione" o simili sull'apparecchiatura o sulle etichette segnala il pericolo di accensione nelle aree in cui è presente un'atmosfera esplosiva. L'apparecchiatura può essere aperta solo quando l'alimentazione è scollegata ed è trascorso il tempo indicato sull'etichetta o nel manuale delle istruzioni per consentirne il raffreddamento. L'operazione può essere effettuata esclusivamente da personale dell'assistenza qualificato.

## **SVARBU**

Šio prietaiso laidų prijungimo ir instaliacijos saugos instrukcijos

Toliau išvardinti saugumo reikalavimai taikomi konkrečiai visoms ES šalims narėms. Jų turi būti griežtai paisoma, kad būtų užtikrintai laikomasi Žemos įtampos direktyvos. Ne ES narės taip pat turi laikytis toliau pateikiamų reikalavimų nebent juos pakeičia vietiniai ar Nacionaliniai standartai.



1. Turi būti atliktas tinkamas įžeminimas visuose įžeminimo taškuose, vidiniuose ir išoriniuose, kur numatyta.
2. Visos apsauginės dangos ir įžemikliai po instaliacijos ar remonto turi būti pakeisti. Visų įžeminimo terminalų vientisumo priežiūra turi būti atliekama nuolat.
3. Maitinimo tinklo laidai turi atitikti IEC227 ar IEC245 reikalavimus.
4. Visi laidai turi būti tinkami naudojimui aplinkos temperatūroje, aukštesnėje nei 75°C.
5. Visi naudojamų kabelių rieboškiai turi būti tokių vidinių matmenų, kad būtų galimas tinkamas kabelio pritvirtinimas.
6. Saugaus šio prietaiso veikimo užtikrinimui, prijungimas prie maitinimo tinklo turi būti atliekamas tik per automatinį pertraukiklį, kuris atjungs visas grandines nešančius konduktorius linijos gedimo metu. Automatinis pertraukiklis taip pat gali turėti mechaniškai veikiantį izoliavimo jungiklį. Jeigu ne, tuomet turi būti nurodytos kitos įrenginio atjungimo priemonės, ir aiškiai pažymėtos, kad jos tokios yra. Automatiniai perjungikliai ar jungikliai turi atitikti pripažintus standartus, tokius kaip IEC947. Visi laidai turi atitikti visus vietinius standartus.
7. Kur įrenginys ar dangos yra pažymėti simboliu dešinėje, žemiau turi būti pavojinga įtampa. Šios dangos turi būti nuimamos tik tada, kai srovė yra pašalinta iš įrenginio - ir tik tuomet tai turi atlikti apmokytas personalas. 
8. Ten kur įrenginys ar dangos yra pažymėti simboliu dešinėje, ten yra pavojus nuo karštų paviršių apačioje. Šios dangos gali būti nuimamos tik apmokyto personalo, kai srovė yra pašalinta iš įrenginio. Tam tikri paviršiai gali išlikti karšti liečiant. 
9. Ten kur įrenginys ar dangos yra pažymėti simboliu dešinėje, žr. nurodymus Valdymo instrukcijose.
10. Visi grafiniai simboliai naudojami šiam produktui yra iš vieno ar daugiau toliau išvardintų standartų: EN61010-1, IEC417, ir ISO3864. 
11. Ten, kur įrenginys ar etiketės yra pažymėti "Neatidaryti esant srovei tiekimui" ar panašiai, yra užsidegimo pavojus tose vietose, kur yra sprogstamoji atmosfera. Šis įrenginys gali būti atidarytas tuomet, kai yra pašalinta srovė, ir praėjęs atitinkamas laikas, nurodytas etiketėje ar valdymo instrukcijoje, pakankamas įrenginio ataušimui - ir tai tik apmokyto personalo.

## **SVARĪGI**

**Drošības norādījumi šīs iekārtas pievienošanai un uzstādīšanai**



**Turpmākie drošības norādījumi attiecas uz visām ES dalībvalstīm. Tie ir stingri jāievēro, lai nodrošinātu atbilstību Zemsprieguma direktīvai.**

**Turpmāk norādītais jāievēro arī valstīs, kas nav ES dalībvalstis, ja vien šos norādījumus neaizstāj vietējie vai valsts standarti.**

1. Visi pieejamie iekšējie un ārējie zemējuma punkti ir atbilstoši jāiezemē.
2. Pēc uzstādīšanas vai problēmu risināšanas visi drošības pārsegi un drošības zemējuma savienojumi ir jāpievieno atpakaļ. Visiem zemējuma savienojumiem vienmēr jābūt iezemētiem.
3. Elektropadeves vadiem jāatbilst IEC227 vai IEC245 prasībām.
4. Visai elektroinstalācijai jābūt piemērotai lietošanai apkārtējā temperatūrā, kas pārsniedz 75°C.
5. Visu izmantoto kabeļu blīvju iekšējiem izmēriem jābūt tādiem, lai atbilstoši nostiprinātu kabeli.
6. Lai nodrošinātu šīs iekārtas drošu darbību, savienojums ar elektropadeves tīklu jāizveido, izmantojot slēdzi, kas kļūmes gadījumā atvienos visas ķēdes, kurās ir vadītāji. Slēdzī var būt iestrādāts arī mehānisks pārtraucējslēdzis. Ja tāda nav, tad ir jāuzstāda cita veida ierīce iekārtas atvienošanai no strāvas padeves un tā atbilstoši un skaidri jāmarķē. Slēdžiem jāatbilst kādam vispārātzītam standartam, piemēram, IEC947. Visai elektroinstalācijai jāatbilst vietējiem standartiem.
7. Vietās, kur iekārta vai tās pārsegi ir marķēti ar labajā pusē norādīto simbolu, visticamāk, zem tiem ir bīstams spriegums. Šos pārsegus drīkst noņemt tikai tad, ja iekārta ir atvienota no strāvas padeves, – un šos darbus drīkst veikt tikai atbilstoši apmācīti remontdarbu darbinieki. 
8. Vietās, kur iekārta vai tās pārsegi ir marķēti ar labajā pusē norādīto simbolu, apdraudējumu izraisa zem tiem esošās karstās virsmas. Šos pārsegus drīkst noņemt tikai atbilstoši apmācīti remontdarbu darbinieki, kad iekārta ir atvienota no strāvas padeves. Iespējams, dažas virsmas arī pēc iekārtas atvienošanas paliks karstas. 
9. Ja iekārta vai pārsegi ir marķēti ar labajā pusē esošo simbolu, skatiet operatora rokasgrāmatā ietvertos norādījumus. 
10. Visi šajā izstrādājumā izmantotie grafiskie simboli atbilst vienam vai vairākiem no šiem standartiem: EN61010-1, IEC417 un ISO3864.
11. Ja iekārtai vai uzlīmēm ir marķējums "Neatvērt, kamēr pieslēgta strāvai" vai tamlīdzīga norāde, tas nozīmē, ka sprādzienbīstamā vidē ir uzliesmošanas bīstamība. Šo iekārtu drīkst atvērt tikai tad, ja ir atvienota strāva un ir nogaidīts iekārtas atdzišanās nepieciešamais laiks, kas norādīts uzlīmē vai ekspluatācijas rokasgrāmatā, – un šos darbus drīkst veikt tikai atbilstoši apmācīti remontdarbu darbinieki.

**IMPORTANTI****STRUZZJONIJIET TAS-SIGURTÀ GĦALL-WIRING U  
L-INSTALLAZZJONI TAT-TAGĦMIR**

L-istruzzjonijiet tas-sigurtà japplikaw speċifikament għall-Istati Membri ta' l-UE. Dawn għandhom jiġu osservati b'mod strett biex tkun żgurata l-konformità mad-Direttiva dwar il-Vultaġġ Baxx. Stati li mhumiex membri ta' l-UE għandhom ukoll ikunu konformi ma' dan li ġejjilief jekk dawn ikunu sostituti mill-Istandards lokali jew Nazzjonali.



1. Konnessjonijiet adegwati ta' l-ert għandhom isiru għall-punti kollha ta' l-ert, interni u esterni, fejn ikun ipprovdut.
2. Wara l-installazzjoni jew meta tipprova ssolvi xi problema, l-għatjien kollha tas-sigurtà u l-erts tas-sigurtà għandhom jitpoġġew lura f'posthom. L-integrità tat-terminali kollha ta' l-ert għandha tinżamm f'kull hin.
3. Il-wajers tal-provvista tad-dawl għandhom ikunu konformi ml-ftigijiet ta' IEC227 jew IEC245.
4. Il-*wiring* kollu għandu jkun adattat għall-użu f'temperatura ta' l-ambjent ta' iktar minn 75°C.
5. Il-*glands* tal-kejbils kollha li jintużw iridu jkunu ta' daqs intern tali li jipprovdut ankoraġġ adegwat lill-kejbil.
6. Biex tiżgura t-tħaddim sigur ta' dan it-tagħmir, il-konnessjoni mal-provvista tad-dawl għandha ssir biss permezz ta' *circuit breaker* li jiskonnetta l-kondukturi kollha li jkunu jgħorru ċ-ċirkuwiti f'sitwazzjoni meta jkun hemm il-ħsara. Is-*circuit breaker* jista' wkoll jinkludi swiċċ li jiżola li jaħdem b'mod mekkaniku. Jekk dan ma jkunx il-każ, mezz ieħor ta' kif it-tagħmir jiġi skonnettjat minn mal-provvista tad-dawl għandu jkun ipprovdut, u jkun immrkat b'mod ċar li hu hekk. Is-*circuit breakers* jew swiċċijiet iridu jkunu konformi ma' standard rikonoxxut bħal IEC947. Il-*wiring* kollu jrid ikun konformi ma' l-istandards lokali, jekk ikun hemm.
7. Meta t-tagħmir jew l-għatjien ikunu mmarkati bis-simbolu fuq il-lemin, x'aktarx li jkun hemm vultaġġi perikolużi taħthom. Dawn l-għatjien għandhom jitneħħew biss meta titneħħa l-provvista tad-dawl mit-tagħmir - u minn ħaddiema tal-manutenzjoni mħarrġa biss. 
8. Meta t-tagħmir jew l-għatjien ikunu mmarkati bis-simbolu fuq il-lemin, ikun hemm periklu mill-uċuħ jaħarqu li jkun hemm taħthom. Dawn l-għatjien għandhom jitneħħew biss minn ħaddiema tal-manutenzjoni mħarrġa meta titneħħa l-provvista tad-dawl mit-tagħmir. Ċerti wċuħ jistgħu jibqgħu jaħarqu meta tmisshom. 
9. Meta t-tagħmir jew l-għatjien ikunu mmarkati bis-simbolu fuq il-lemin, irreferi għall-Manwal ta' l-Operatur għall-istruzzjonijiet.
10. Is-simboli grafiċi kollha użati f'dan il-prodott huma minn wieħed jew iktar mill-istandards li ġejjin: EN61010-1, IEC417, u ISO3864. 
11. Fejn it-tagħmir u t-tikketti huma mmarkati bil-kliem "Tiftaħ Meta Jkun Energizzat" jew kliem simili, hemm periklu ta' nar f'żoni fejn atmosfera esplosiva hi preżenti. It-tagħmir għandu jinfetaħ biss meta l-provvista tad-dawl tkun mitfija u jkun għadda ħin biżżejjed, kif speċifikat fuq it-tikketta jew fil-manwal ta' l-istruzzjonijiet, biex it-tagħmir ikun kesah – u t-tagħmir għandu jinfetaħ biss minn staff li jkun imħarreg.



## **VIKTIG**

### **Sikkerhetsinstruks for tilkobling og installasjon av dette utstyret.**



**Følgende sikkerhetsinstruksjoner gjelder spesifikt alle EU medlemsland og land med i EØS-avtalen. Instruksjonene skal følges nøye slik at installasjonen blir i henhold til lavspenningsdirektivet. Den bør også følges i andre land, med mindre annet er spesifisert av lokale- eller nasjonale standarder.**

1. Passende jordforbindelser må tilkobles alle jordingspunkter, interne og eksterne hvor disse forefinnes.
2. Etter installasjon eller feilsøking skal alle sikkerhetsdeksler og jordforbindelser reetableres. Jordingsforbindelsene må alltid holdes i god stand.
3. Kabler fra spenningsforsyning skal oppfylle kravene spesifisert i IEC227 eller IEC245.
4. Alle ledningsforbindelser skal være konstruert for en omgivelsestemperatur høyere en 750°C.
5. Alle kabelforskruvninger som benyttes skal ha en indre dimensjon slik at tilstrekkelig avlastning oppnåes.
6. For å oppnå sikker drift og betjening skal forbindelsen til spenningsforsyningen bare skje gjennom en strømbryter (minimum 10A) som vil bryte spenningsforsyningen til alle elektriske kretser ved en feilsituasjon. Strømbryteren kan også inneholde en mekanisk operert bryter for å isolere instrumentet fra spenningsforsyningen. Dersom det ikke er en mekanisk operert bryter installert, må det være en annen måte å isolere utstyret fra spenningsforsyningen, og denne måten må være tydelig merket. Kretsbytere eller kontakter skal oppfylle kravene i en anerkjent standard av typen IEC947 eller tilsvarende.
7. Der hvor utstyr eller deksler er merket med symbol for farlig spenning, er det sannsynlig at disse er tilstede bak dekslet. Disse dekslene må bare fjernes når spenningsforsyning er frakoblet utstyret, og da bare av trent servicepersonell. 
8. Der hvor utstyr eller deksler er merket med symbol for meget varm overflate, er det sannsynlig at disse er tilstede bak dekslet. Disse dekslene må bare fjernes når spenningsforsyning er frakoblet utstyret, og da bare av trent servicepersonell. Noen overflater kan være for varme til å berøres i opp til 45 minutter etter spenningsforsyning frakoblet. 
9. Der hvor utstyret eller deksler er merket med symbol, vennligst referer til instruksjonsmanualen for instruksjer. 
10. Alle grafiske symboler brukt i dette produktet er fra en eller flere av følgende standarder: EN61010-1, IEC417 & ISO3864.
11. Når utstyr eller merkelapper bærer advarselen "Må ikke åpnes under spenning" eller lignende, innebærer det fare for eksplosjon i områder med en eksplosiv atmosfære. Utstyret skal bare åpnes når det ikke er noen strømtilførsel, og etter at det har hatt tilstrekkelig tid til å kjøle ned, som spesifisert på merkelappen eller i håndboken. Selv da skal utstyret bare åpnes av erfarne serviceteknikere.

## **WAŻNE!**

### **Zalecenia dotyczące bezpieczeństwa w zakresie podłączania i instalacji tego urządzenia**



**Następujące zalecenia dotyczą zwłaszcza stosowania urządzenia we wszystkich krajach Unii Europejskiej. Należy się ściśle do nich stosować w celu zapewnienia zgodności z dyrektywą niskonapięciową. W przypadku instalacji urządzenia w krajach nienależących do Unii Europejskiej należy również przestrzegać poniższych zaleceń, chyba że są one zastąpione lokalnymi lub ogólnokrajowymi standardami.**

1. Urządzenie należy podłączyć kablem uziemiającym do wszystkich punktów uziemienia (wewnętrznych i zewnętrznych).
2. Po instalacji lub czynnościach serwisowych należy zamknąć wszystkie pokrywy zabezpieczające i ponownie podłączyć uziemienie. Należy pilnować, by nie doszło do przerwania uziemienia.
3. Przewody zasilające powinny być zgodne z wymaganiami normy IEC227 lub IEC245.
4. Wszystkie przewody powinny być odpowiednie do użytku w środowisku o temperaturze wyższej niż 75°C.
5. Wszystkie dławnice powinny mieć wymiary wewnętrzne zapewniające pewne umocowanie przewodów.
6. W celu zapewnienia bezpiecznej pracy urządzenie należy podłączyć do sieci tylko za pośrednictwem wyłącznika automatycznego, który w razie awarii odłączy wszystkie obwody, w których przepływa prąd. Wyłącznik automatyczny może być również wyposażony w mechaniczny odłącznik napięcia. W przeciwnym razie należy zapewnić i jasno oznaczyć inną możliwość odłączenia urządzenia od zasilania. Wyłączniki automatyczne oraz odłączniki powinny być zgodne z uznawanymi standardami, takimi jak norma IEC947. Wszystkie przewody muszą być zgodne z lokalnymi przepisami.
7. Pod pokrywami lub elementami urządzenia oznaczonymi symbolem pokazanym na rysunku po prawej stronie może występować niebezpieczne napięcie elektryczne. Te pokrywy mogą być zdejmowane tylko po odłączeniu zasilania, wyłącznie przez odpowiednio przeszkolonych pracowników serwisu. 
8. Pod pokrywami lub elementami urządzenia oznaczonymi symbolem pokazanym na rysunku po prawej stronie znajdują się gorące powierzchnie. Te pokrywy mogą być zdejmowane tylko po odłączeniu zasilania, wyłącznie przez odpowiednio przeszkolonych pracowników serwisu. Niektóre powierzchnie mogą pozostać nagrzane przez pewien czas po odłączeniu zasilania. 
9. W przypadku sprzętu oraz pokryw oznaczonych symbolem pokazanym na rysunku po prawej stronie należy zapoznać się ze wskazówkami w Instrukcji operatora i stosować się do nich. 
10. Wszystkie symbole graficzne zastosowane do oznaczenia produktu pochodzą z następujących norm: EN61010-1, IEC417 lub ISO3864.
11. Oznaczenie „Nie otwierać, gdy urządzenie jest pod napięciem” lub podobne oznaczenia informują o ryzyku zapłonu w miejscach, gdzie występuje zagrożenie wybuchem. Urządzenie należy otwierać tylko po odłączeniu zasilania i po upływie czasu na ostygnięcie urządzenia oznaczonego na etykiecie lub w instrukcji obsługi. Urządzenie mogą otwierać wyłącznie odpowiednio przeszkoleni pracownicy serwisu.

## **IMPORTANTE**

### **Instruções de segurança para ligação e instalação deste aparelho.**



**As seguintes instruções de segurança aplicam-se especificamente a todos os estados membros da UE. Devem ser observadas rigidamente por forma a garantir o cumprimento da Directiva sobre Baixa Tensão. Relativamente aos estados que não pertençam à UE, deverão cumprir igualmente a referida directiva, exceptuando os casos em que a legislação local a tiver substituído.**

1. Devem ser feitas ligações de terra apropriadas a todos os pontos de terra, internos ou externos.
2. Após a instalação ou eventual reparação, devem ser recolocadas todas as tampas de segurança e terras de protecção. Deve manter-se sempre a integridade de todos os terminais de terra.
3. Os cabos de alimentação eléctrica devem obedecer às exigências das normas IEC227 ou IEC245.
4. Os cabos e fios utilizados nas ligações eléctricas devem ser adequados para utilização a uma temperatura ambiente até 75°C.
5. As dimensões internas dos buçins dos cabos devem ser adequadas a uma boa fixação dos cabos.
6. Para assegurar um funcionamento seguro deste equipamento, a ligação ao cabo de alimentação eléctrica deve ser feita através de um disjuntor (min. 10A) que desligará todos os condutores de circuitos durante uma avaria. O disjuntor poderá também conter um interruptor de isolamento accionado manualmente. Caso contrário, deverá ser instalado qualquer outro meio para desligar o equipamento da energia eléctrica, devendo ser assinalado convenientemente. Os disjuntores ou interruptores devem obedecer a uma norma reconhecida, tipo IEC947.
7. Sempre que o equipamento ou as tampas contiverem o símbolo, é provável a existência de tensões perigosas. Estas tampas só devem ser retiradas quando a energia eléctrica tiver sido desligada e por Pessoal da Assistência devidamente treinado. 
8. Sempre que o equipamento ou as tampas contiverem o símbolo, há perigo de existência de superfícies quentes. Estas tampas só devem ser retiradas por Pessoal da Assistência devidamente treinado e depois de a energia eléctrica ter sido desligada. Algumas superfícies permanecem quentes até 45 minutos depois. 
9. Sempre que o equipamento ou as tampas contiverem o símbolo, o Manual de Funcionamento deve ser consultado para obtenção das necessárias instruções. 
10. Todos os símbolos gráficos utilizados neste produto baseiam-se em uma ou mais das seguintes normas: EN61010-1, IEC417 e ISO3864.
11. Sempre que o equipamento ou as etiquetas apresentarem o aviso "Não abrir quando ligado à corrente" ou semelhante, existe um risco de ignição em atmosferas explosivas. Este equipamento só deve ser aberto depois de desligado da corrente eléctrica e o tempo de arrefecimento adequado especificado na etiqueta ou no manual de instruções ter decorrido. O equipamento só pode ser aberto por técnicos qualificados.

## **DÔLEŽITÉ**

### **Bezpečnostné pokyny pre zapojenie káblov a inštaláciu tohto prístroja**



**Nasledovné bezpečnostné pokyny sa vzťahujú konkrétne na všetky členské štáty EÚ. Musia byť striktne dodržané, aby sa zaistila zhoda so Smernicou o nízkom napätí. Štáty, ktoré nie sú členskými štátmi EÚ by mali nasledovné pokyny taktiež dodržiavať, pokiaľ nie sú nahradené miestnymi alebo národnými normami.**

1. Adekvátne uzemnenia musia byť vykonané na všetkých bodoch uzemnenia, interných aj externých, tam, kde sú poskytnuté.
2. Po inštalácii alebo riešení problémov musia byť všetky bezpečnostné kryty a bezpečnostné uzemnenia vymenené. Integrita všetkých uzemňovacích terminálov musí byť vždy zachovaná.
3. Káble sieťového napájania musia byť v zhode s požiadavkami IEC227 alebo IEC245.
4. Všetky káblové pripojenia by mali byť vhodné pre používanie v teplote okolia vyššej, ako 75°C.
5. Všetky použité káblové priedochodky musia mať také vnútorné rozmery, aby poskytovali adekvátne uchopenie kábla.
6. Pre zaistenie bezpečnej prevádzky tohto zariadenia musí byť pripojenie k sieťovému napájaniu zapojené len cez prerušovač obvodu, ktorý počas poruchovej situácie odpojí všetky obvody elektrických vodičov. Prerušovač obvodu by mal obsahovať aj mechanicky ovládaný úsekový vypínač. Ak nie, musí byť poskytnutý iný spôsob odpojenia zariadenia od sieťového napájania a tento spôsob musí byť zreteľne označený. Prerušovače obvodu alebo spínače musia byť v zhode s uznanou normou, ako napr. IEC947. Všetky káblové pripojenia musia vyhovovať akýmkoľvek miestnym normám.
7. Tam, kde je zariadenie alebo kryty označené symbolom na pravej strane, sa pravdepodobne nachádza nebezpečné napätie. Tieto kryty by sa mali odoberať len vtedy, keď je zariadenie odpojené od elektrickej energie a len vyškoleným servisným personálom. 
8. Tam, kde je zariadenie alebo kryty označené symbolom na pravej strane, existuje nebezpečenstvo horúcich povrchov. Tieto kryty by mali byť odstraňované len vyškoleným servisným personálom, pričom je zariadenie odpojené od elektrickej energie. Určité povrchy môžu zostať horúce na dotyk. 
9. V miestach, kde je zariadenie alebo kryty označené symbolom na pravej strane, si kvôli pokynom pozrite Operátorskú príručku. 
10. Všetky obrázkové symboly použité pri tomto produkte zodpovedajú jednej alebo viacerým nasledujúcim normám: EN61010-1, IEC417 a ISO3864.
11. V miestach, kde je zariadenie alebo značky označené nápisom "Neotvárať pod elektrickým prúdom" alebo podobné, existuje nebezpečenstvo vznietenia v oblastiach s prítomnosťou výbušného ovzdušia. Toto zariadenie sa smie otvárať len v prípade odpojenia od elektrického napájania a ponechania zariadenia vychladnúť po dobu uplynutia dostatočného času tak, ako je to uvedené na štítku alebo v návode na použitie - a len vyškoleným servisným personálom.

## **POMEMBNO**

### Varnostna navodila za povezavo in vgradnjo naprave



Naslednja varnostna navodila veljajo za vse države članice EU. Zaradi zagotovitve skladnosti z nizkonapetostno direktivo morate navodila strogo upoštevati. V državah, ki niso članice EU, je treba upoštevati tudi naslednje smernice, razen če jih ne zamenjujejo lokalni ali nacionalnimi standardi.

1. Do vseh ozemljitvenih točk, notranjih in zunanjih, ki so na voljo, morajo biti speljane ustrezne ozemljitvene povezave.
2. Po vgradnji ali odpravljanju težav je treba namestiti vse varnostne pokrove in zaščitne ozemljitve. Brezhibnost vseh ozemljitvenih priključkov je treba nenehno preverjati.
3. Omrežni napajalni kabli morajo biti skladni z zahtevami standarda IEC227 ali IEC245.
4. Vsa napeljava mora biti primerna za uporabi pri temperaturi okolja, višji od 75 °C.
5. Notranje dimenzije kablskih tesnilk morajo zagotavljati ustrezno pritrditev kablov.
6. Za zagotovitev varnega delovanja opreme mora biti povezava z omrežnim napajanjem vzpostavljena prek odklopnega stikala, ki v primeru napake izklopi vse tokokroge s prevodniki. Odklopno stikalo lahko vključuje tudi mehansko izolacijsko stikalo. V nasprotnem primeru morajo biti zagotovljeni in jasno označeni drugi načini za izklop opreme iz napajanja. Odklopna in druga stikala morajo biti skladna z uveljavljenimi standardi, kot je IEC947. Vsa napeljava mora biti skladna z lokalnimi standardi.
7. V opremi ali pod pokrovi, ki so označeni s simbolom na desni, je prisotna nevarna napetost. Te pokrove je dovoljeno odstraniti samo, če je napajanje opreme izklopljeno. To lahko izvaja samo usposobljeno servisno osebje. 
8. Pri opremi ali pod pokrovi, ki so označeni s simbolom na desni, so prisotne nevarne vroče površine. Te pokrove lahko odstranjuje samo usposobljeno servisno osebje. Napajanje opreme mora biti izklopljeno. Določene površine so lahko vroče. 
9. Pri opremi ali pokrovih, ki so označeni s simbolom na desni, si za navodila oglejte priročnik za upravljanje. 
10. Vsi uporabljeni grafični simboli so iz enega ali več naslednjih standardov: EN61010-1, IEC417 in ISO3864.
11. Če je na opremi ali oznakah navedeno "Ne odpirajte, če je pod napetostjo" ali podobno opozorilo, je na območjih z eksplozivnim ozračjem prisotna nevarnost vžiga. To opremo je dovoljeno odpirati samo, če je napajanje izklopljeno in je poteklo dovolj časa, da se oprema ohladi, kot je navedeno na oznaki ali v priročniku z navodili. Opremo lahko odpira samo usposobljeno servisno osebje.

## **IMPORTANTE**

### **Instrucciones de seguridad para el montaje y cableado de este aparato.**



**Las siguientes instrucciones de seguridad, son de aplicacion especifica a todos los miembros de la UE y se adjuntaran para cumplir la normativa europea de baja tension.**

1. Se deben preveer conexiones a tierra del equipo, tanto externa como internamente, en aquellos terminales previstos al efecto.
2. Una vez finalizada las operaciones de mantenimiento del equipo, se deben volver a colocar las cubiertas de seguridad aasi como los terminales de tierra. Se debe comprobar la integridad de cada terminal.
3. Los cables de alimentacion electrica cumpliran con las normas IEC 227 o IEC 245.
4. Todo el cableado sera adecuado para una temperatura ambiental de 75°C.
5. Todos los prensaestopas seran adecuados para una fijacion adecuada de los cables.
6. Para un manejo seguro del equipo, la alimentacion electrica se realizara a traves de un interruptor magnetotermico ( min 10 A ), el cual desconectara la alimentacion electrica al equipo en todas sus fases durante un fallo. Los interruptores estaran de acuerdo a la norma IEC 947 u otra de reconocido prestigio.
7. Cuando las tapas o el equipo lleve impreso el simbolo de tension electrica peligrosa, dicho alojamiento solamente se abra una vez que se haya interrumpido la alimentacion electrica al equipo asimismo la intervencion sera llevada a cabo por personal entrenado para estas labores. 
8. Cuando las tapas o el equipo lleve impreso el simbolo, hay superficies con alta temperatura, por tanto se abra una vez que se haya interrumpido la alimentacion electrica al equipo por personal entrenado para estas labores, y al menos se esperara unos 45 minutos para enfriar las superficies calientes. 
9. Cuando el equipo o la tapa lleve impreso el simbolo, se consultara el manual de instrucciones. 
10. Todos los simbolos graficos usados en esta hoja, estan de acuerdo a las siguientes normas EN61010-1, IEC417 & ISO 3864.
11. Cuando el equipo o las etiquetas tienen la indicación " No abrir mientras reciba energía" u otra similar, existe el peligro de ignición en zonas donde haya un ambiente explosivo. Este equipo sólo debe ser abierto por personal de servicio cualificado después de apagarlo y dejar pasar el intervalo de tiempo correspondiente indicado en la etiqueta o el manual de instrucciones para que el equipo se enfríe.

## **VIKTIGT**

**Säkerhetsföreskrifter för kablage och installation av denna apparat.**

**Följande säkerhetsföreskrifter är tillämpliga för samtliga EU-medlemsländer. De skall följas i varje avseende för att överensstämja med Lågspännings direktivet. Icke EU medlemsländer skall också följa nedanstående punkter, såvida de inte övergrips av lokala eller nationella föreskrifter.**

1. Tillämplig jordkontakt skall utföras till alla jordade punkter, såväl internt som externt där så erfordras.
2. Efter installation eller felsökning skall samtliga säkerhetshöljen och säkerhetsjord återplaceras. Samtliga jordterminaler måste hållas obrutna hela tiden.
3. Matningsspänningens kabel måste överensstämja med föreskrifterna i IEC227 eller IEC245.
4. Allt kablage skall vara lämpligt för användning i en omgivningstemperatur högre än 75°C.
5. Alla kabelförskruvningar som används skall ha inre dimensioner som motsvarar adekvat kabelförankring.
6. För att säkerställa säker drift av denna utrustning skall anslutning till huvudströmmen endast göras genom en säkring (min 10A) som skall frångöras alla strömförande kretsar när något fel uppstår. Säkningen kan även ha en mekanisk frånskiljare. Om så inte är fallet, måste ett annat förfarande för att frånskilja utrustningen från strömförsörjning tillhandahållas och klart framgå genom markering. Säkring eller omkopplare måste överensstämja med en gällande standard såsom t ex IEC947.
7. Där utrustning eller hölje är markerad med vidstående symbol föreligger risk för livsfarlig spänning i närheten. Dessa höljen får endast avlägsnas när strömmen ej är ansluten till utrustningen - och då endast av utbildad servicepersonal. 
8. När utrustning eller hölje är markerad med vidstående symbol föreligger risk för brännskada vid kontakt med uppvärmd yta. Dessa höljen får endast avlägsnas av utbildad servicepersonal, när strömmen kopplats från utrustningen. Vissa ytor kan vara mycket varma att vidröra även upp till 45 minuter efter avstängning av strömmen. 
9. När utrustning eller hölje markerats med vidstående symbol bör instruktionsmanualen studeras för information. 
10. Samtliga grafiska symboler som förekommer i denna produkt finns angivna i en eller flera av följande föreskrifter:- EN61010-1, IEC417 & ISO3864.
11. För utrustning som markerats med föreskrifter som "Öppna inte när strömmen är på", eller liknande, råder explosionsrisk när det förekommer explosiva ångor. Utrustningen får endast öppnas efter att strömmen stängts av och efter att utrustningen fått svalna under så lång tid som anges i instruktionsboken. Öppandet får endast utföras av utbildad servicepersonal.





## **Appendix B      Return of Materials**

### **Service Support**

To expedite the return process outside of the United States, contact the nearest Emerson representative. Within the United States, call the Emerson Process Management Instrument and Valves Response Center using the 1-800-654-RSMT (7768) toll-free number. This center, available 24 hours a day, will assist you with any needed information or materials.

The center will ask for product model and serial numbers and will provide a Return Material Authorization (RMA) number. The center will also ask for the process material to which the product was last exposed.

Emerson Process Management Instrument and Valves Response Center representatives will explain the additional information and procedures necessary to return goods exposed to hazardous substances.

含有 China RoHS 管控物质超过最大浓度限值的部件型号列表 SPS 4001B  
List of SPS 4001B Parts with China RoHS Concentration above MCVs

部件名称 Part Name	有害物质 / Hazardous Substances					
	铅 Lead (Pb)	汞 Mercury (Hg)	镉 Cadmium (Cd)	六价铬 Hexavalent Chromium (Cr +6)	多溴联苯 Polybrominated biphenyls (PBB)	多溴联苯醚 Polybrominated diphenyl ethers (PBDE)
电子组件 Electronics Assembly	X	○	○	○	○	○
传感器组件 Sensor Assembly	X	○	○	○	○	○

本表格系依据 SJ/T11364 的规定而制作。

This table is proposed in accordance with the provision of SJ/T11364.

○: 意为该部件的所有均质材料中该有害物质的含量均低于 GB/T 26572 所规定的限量要求。

○: Indicate that said hazardous substance in all of the homogeneous materials for this part is below the limit requirement of GB/T 26572.

X: 意为在该部件所使用的所有均质材料里，至少有一类均质材料中该有害物质的含量高于 GB/T 26572 所规定的限量要求。

X: Indicate that said hazardous substance contained in at least one of the homogeneous materials used for this part is above the limit requirement of GB/T 26572.

部件名称 Part Name	组装备件说明 Spare Parts Descriptions for Assemblies
电子组件 Electronics Assembly	电子线路板组件 Electronic Board Assemblies 液晶显示屏或本地操作界面显示屏 LCD or LOI Display
传感器组件 Sensor Assembly	传感器模块 Sensor Module

# Index

<b>A</b>	Handshake Signal ..... 1-3	<b>T</b>
Accessories ..... 1-4	Humidity Range ..... 1-3	Timed Interval Calibration ..... 3-3
Ambient Temperature . . . 1-3, 2-1, 1-1		
<b>B</b>	<b>I</b>	<b>W</b>
Bottle Rack ..... 1-4	In-cal Relay Contact ..... 1-3	Warranty Service . . . . . B-1
<b>C</b>	Input Power ..... 1-3	
Cabling Distance ..... 1-3	Instrument Air ..... 3-3	
Cal Failed Relay Contact ..... 1-3	Instrument Air Supply ..... 2-2	
Cal Recommended . . . . . 1-6, 3-3	<b>M</b>	
Calibrated Gas Mixtures ..... 3-2	Main Components ..... 1-4	
Calibration ..... 1-4	Manifold ..... 1-4	
Calibration Components ..... 1-4	Materials of Construction ..... 1-3	
Calibration Gas ..... 2-2	<b>N</b>	
Flow Meter . . . . . 1-5, 3-3	NEMA Cabinet ..... 1-2	
Calibration Gas 1 ..... 1-6	<b>O</b>	
Calibration Gas 2 ..... 1-6	O2 Calibration Gas 1 ..... 2-2	
Calibration Gas Bottles ..... 1-4	O2 Calibration Gas 2 ..... 2-2	
Calibration Gas Solenoids ..... 1-4	OCX Specifications ..... 1-3	
Calibration Gas Tanks ..... 3-1	<b>P</b>	
Calibration Recommended ..... 1-4	Part Number ..... 1-3	
Certification ..... 1-3	Piping Distance ..... 1-3	
Check Valve . . . . . 2-2, 3-2	Power Consumption ..... 1-3	
Circuit Board ..... 1-5	Pressure Regulator . . . 1-5, 2-2, 3-3	
Component Checklist ..... 1-1	Pressure Switch ..... 1-5	
<b>D</b>	Programmable Logic Device . . . 1-6	
Drain Valve ..... 1-5	<b>R</b>	
<b>E</b>	Reference Air ..... 2-2	
Electrical Connections ..... 2-6	Reference Air Flow Meter . 1-5, 3-3	
Enclosure Protection ..... 1-3	Reference Air Pressure	
Essential Instructions . . . . . i-i	Regulator ..... 3-3	
Explosion-proof Option ..... 1-3	Remote-site Calibrations ..... 3-4	
External Electrical Noise ..... 1-3	Returning Material . . . . . .B-1	
<b>F</b>	<b>S</b>	
Factory Repair . . . . . B-1	Specifications ..... 1-3	
Flow Regulators ..... 1-4	SPS 4001B Calibration Setup . . 1-7	
<b>H</b>	SPS 4001B Components ..... 1-4	
Handshake ..... 2-4	SPS 4001B Package ..... 1-1	
Handshake Mode ..... 3-3		



## **WARRANTY**

Rosemount warrants that the equipment manufactured and sold by it will, upon shipment, be free of defects in workmanship or material. Should any failure to conform to this warranty become apparent during a period of one year after the date of shipment, Rosemount shall, upon prompt written notice from the purchaser, correct such nonconformity by repair or replacement, F.O.B. factory of the defective part or parts. Correction in the manner provided above shall constitute a fulfillment of all liabilities of Rosemount with respect to the quality of the equipment.

**THE FOREGOING WARRANTY IS EXCLUSIVE AND IN LIEU OF ALL OTHER WARRANTIES OF QUALITY WHETHER WRITTEN, ORAL, OR IMPLIED (INCLUDING ANY WARRANTY OF MERCHANTABILITY OF FITNESS FOR PURPOSE).**

The remedy(ies) provided above shall be purchaser's sole remedy(ies) for any failure of Rosemount to comply with the warranty provisions, whether claims by the purchaser are based in contract or in tort (including negligence).

Rosemount does not warrant equipment against normal deterioration due to environment. Factors such as corrosive gases and solid particulates can be detrimental and can create the need for repair or replacement as part of normal wear and tear during the warranty period.

Equipment supplied by Rosemount Inc. but not manufactured by it will be subject to the same warranty as is extended to Rosemount by the original manufacturer.

At the time of installation it is important that the required services are supplied to the system and that the electronic controller is set up at least to the point where it is controlling the sensor heater. This will ensure, that should there be a delay between installation and full commissioning that the sensor being supplied with ac power and reference air will not be subjected to component deterioration.

## Global Headquarters

### Emerson Automation Solutions

8200 Market Blvd.  
Chanhassen, MN 55317, USA  
📞 +1 800 999 9307 or +1 952 906 8888  
📞 +1 952 949 7001  
✉️ Gas.CSC@Emerson.com

## Latin America Regional Office

### Emerson Automation Solutions

1300 Concord Terrace, Suite 400  
Sunrise, FL 33323, USA  
📞 +1 954 846 5030  
📞 +1 952846 5121  
✉️ RFQ.RMD-RCC@Emerson.com

## Europe Regional Office

### Emerson Automation Solutions Europe GmbH

Neuhofstrasse 19a P.O. Box 1046  
CH 6340 Baar  
Switzerland  
📞 +1 954 846 5030  
📞 +1 952846 5121  
✉️ RFQ.RMD-RCC@Emerson.com

## Asia Pacific Regional Office

### Emerson Automation Solutions Asia Pacific Pte LTD

1 Pandan Crescent  
Singapore 128461  
📞 +65 6777 8211  
📞 +65 6777 0947  
✉️ Enquiries@AP.Emerson.com

## Middle East and Africa Regional Office

### Emerson Automation Solutions

Emerson FZE P.O. Box 17033  
Jebel Ali Free Zone - South 2  
📞 +971 4 8118100  
📞 +971 4 88665465  
✉️ RFQ.RMTMEA@Emerson.com



[Analyticexpert.com](http://Analyticexpert.com)



[Linkedin.com/company/Emerson-Automation-Solutions](https://www.linkedin.com/company/Emerson-Automation-Solutions)



[Twitter.com/Rosemount\\_News](https://twitter.com/Rosemount_News)



[Facebook.com/Rosemount](https://www.facebook.com/Rosemount)



[Youtube.com/user/RosemountMeasurement](https://www.youtube.com/user/RosemountMeasurement)



[Google.com/+RosemountMeasurement](https://plus.google.com/+RosemountMeasurement)

The Emerson logo is a trademark and service mark of Emerson Electric Co.  
Rosemount and Rosemount logotype are trademarks of Emerson.  
All other marks are the property of their respective owners.  
© 2017 Emerson. All rights reserved.