

HART Revision 7 Communication Module (SCM-W-HRT7)



SCM SolaHD™ Communication Module
For use with SolaHD™ SDN-D Power Supplies

TABLE OF CONTENTS

TABLE OF CONTENTS.....	2
REVISION HISTORY.....	3
PREFACE	4
SAFETY INSTRUCTIONS	5
INTRODUCTION	6
1. PRODUCT OVERVIEW	7
1.1 GENERAL SPECIFICATIONS	7
1.2 COMMUNICATION SPECIFICATIONS	7
1.3 CONSTRUCTION	8
1.4 NETWORK AND MODULE STATUS INDICATORS.....	9
1.5 SETUP AND CONNECTIVITY	9
1.5.1 ELECTROSTATIC DISCHARGE	9
1.5.2 POWER SUPPLY REPLACEMENT	9
1.5.3 POWER SUPPLY COMMUNICATION CABLE	10
1.5.4 CONNECTING TO DELTAV CHARM IO	10
1.5.5 CONNECTING TO DELTAV TRADITIONAL IO.....	11
1.5.6 ESTABLISHING MULTI-DROP COMMUNICATION.....	12
1.5.7 SPACING.....	14
2. CONFIGURATION.....	15
2.1 OVERVIEW.....	15
2.2 CONFIGURATION USING AMS TREX.....	15
2.3 CONFIGURATION USING AMS DEVICE MANAGER	16
2.4 HART CONFIGURATION LOCK	16
2.5 BASIC CONFIGURATION OF COMMUNICATION MODULE.....	16
2.6 DEVICE INFORMATION CONFIGURATION	17
2.7 ALARM CONFIGURATION OF COMMUNICATION MODULE.....	19
2.8 UNIT OF MEASUREMENT CONFIGURATION OF COMMUNICATION MODULE	20
3. MONITORING.....	21
3.1 ALERT MESSAGE MAPPING	21
3.2 POWER SUPPLY PARAMETERS AND MAXIMUM VALUES	23
3.3 SCM TEMPERATURE VALUE.....	26
3.4 REVISION INFORMATION.....	27
4. TROUBLESHOOTING	28
4.1 MASTER RESET.....	33
APPENDIX A: FIELD COMMUNICATOR MENU TREE	34
TECHNICAL SUPPORT	37
WARRANTY	37

REVISION HISTORY

Revision Code	Revision Date	Description
Rev. 1.0	8/2022	Final
Rev. 1.1	3/2023	Miscellaneous text and illustrations additions and changes.
Rev. 1.2	11/2023	Updated figure 1.5.5. Miscellaneous text changes.

PREFACE

Thank you for purchasing SolaHD SCM-W-HRT7!

This user manual defines how to use the communication functions of SCM-W-HRT7. It also contains important safety instructions that must be followed during the installation and operation of the communication module. Before attempting to install the product, please read all the safety, installation, and operation warnings and instructions thoroughly.

You can also download the PDF version of this, and other documents, at www.solahd.com.

SAFETY INSTRUCTIONS



CAUTION - Risk of personal injury and explosion hazard.

SAVE THESE INSTRUCTIONS - This manual contains important instructions that should be followed during installation and maintenance.

Risk of personal injury and explosion hazard when used in a Class I, Division 2/Class I, Zone 2 environment.

Refer to the "*Safety Instruction Sheet - SCM Communications Modules*" provided with the product or located on our website at www.SolaHD.com. Be sure to adhere to all safety procedures provided in the sheet.

INTRODUCTION

The SCM Series of SolaHD Communication Modules provides network connectivity support for one or two SDN-D Series power supplies over popular industrial protocols. The SCM-W-HRT7 model provides wired HART protocol support and is fully HART certified.

FEATURES

- Provides a means to connect to two SDN-D Power Supplies to a HART 7 network
- Built-in thermal sensor to measure the device's internal temperature. Since the SCM generates minimal heat itself, the internal temperature of the SCM should be a good proxy for ambient temperature.

WHAT'S INCLUDED

SCM-W-HRT7 ships with the following items:

- 1 x SCM-W-HRT7 Communication Module
- 2 x I2C cables
- SCM Comm Modules Safety Instruction Sheet

ADDITIONAL REQUIREMENTS (NOT INCLUDED)

The following items/accessories not included in the SCM-W-HRT7 package are also needed:

- Device Description (DD) file (www.solahd.com under SDN-D Documents & Drawings)

COMPATIBLE DEVICES/APPLICATIONS

SCM-W-HRT7 is compatible with the following SolaHD SDN-D power supplies:

- SDN1024100D version xx 06 10
- SDN2024100D version xx 05 16

As a HART compliant device, it is designed to work with Emerson's DeltaV™, AMS Device Manager and TREX and other HART Masters.

1. PRODUCT OVERVIEW

1.1 GENERAL SPECIFICATIONS

Table 1.1: General Specifications

Input (from SDN-D Power Supply)	
Nominal Input Voltage	12 VDC
Input Voltage Range	11.6 VDC – 16.8 VDC
Nominal Current	65 mA
Environmental	
Operating Temperature	-40°C to 70°C ambient
Storage Temperature	-40°C to 85°C ambient
Relative Humidity	5–95% RH
Weight/Dimensions	
H x W x D, in. (mm)	5.5 x 1.0 x 4.3 (140 x 25 x 108) with sliding arm 4.9 x 1.0 x 4.3 (123 x 25 x 108) without sliding arm
Net Weight	137gm
Case/Enclosure Material	PC-ABS (Polycarbonate-Acrylonitrile Butadiene Styrene Thermo Plastic)

1.2 COMMUNICATION SPECIFICATIONS

Table 1.2: Communication Specifications

General	
Protocol	HART 7 (Fieldcomm Group Registered)
Physical	
Power Supply Connection	Either 1 or 2 SDN-D Power Supplies can be supported by a single SCM module. Power for SCM and power supply data are provided with included 8-inch cables.
Network Connection and Topologies supported	2-wire terminal connection. Point-to-Point or Multidrop

1.3 CONSTRUCTION

Important parts of the HART communication module are as below.

Figure 1.3: Parts of the HART Communication Module



1.4 NETWORK AND MODULE STATUS INDICATORS

There are two LED indicators on the SCM-W-WRT7, one for Module and one for Network. The table below defines the different status of both the Network and Module LED indicators.

Table 1.4: Network and Module Status Indicators

LED Indicator	Status	Meaning
Module Status	● Green, steady	Normal operation, no errors
	● Red, blinking	Incompatible supply connected
Alarm Status	● Green, steady	No alarm/alerts active
	● Green, blinking	Device Alert active - Maintenance
	● Red, blinking	Device Alert active - Failure
	● Amber, blinking	Process Alarm active

1.5 SETUP AND CONNECTIVITY

1.5.1 ELECTROSTATIC DISCHARGE

NOTICE

Always use ESD precautions when handling electronic circuit equipment as they contain parts and assemblies susceptible to damage by electrostatic discharge (ESD).

To prevent possible electrostatic discharge (ESD) from rendering the SCM non-functional and possible data corruption, it is recommended to take proper precautions when setting up the system or handling products.

- Avoid hand contact by transporting and storing SCMs in static-safe containers.
- Always be properly grounded (e.g., using antistatic wrist strap) when contacting SCM or plugging in or removing cables from power supply or host device.

1.5.2 POWER SUPPLY REPLACEMENT

To avoid any data corruption, when changing one or both power supplies or SCM in a dual power supply and SCM setup, it is recommended to follow these steps:

1. Turn off AC or DC input power to the power supplies,
2. Replace power supplies and/or SCM as intended,
3. Reconnect the mains and communication wiring,
4. Re-apply AC or DC input power to the power supplies.

1.5.3 POWER SUPPLY COMMUNICATION CABLE

Included with the SCM W-HRT7 package are cables for interconnecting to a couple of SDN-D power supply units. This cable is inserted into one of the I2C ports of the SCM W-HRT7. For the location of the I2C port, refer to [Section 1.3](#). The maximum cable length is 200 mm. Additional cables for interconnecting SCM to SOLA power supplies are available as a separate part.

Figure 1.5.3: I2C Cable to Connect Power Supplies to Communication Module

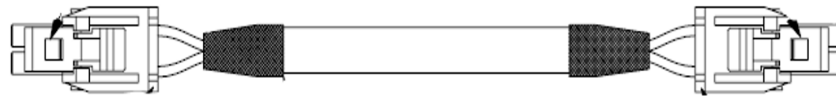

1.5.4 CONNECTING TO DELTAV CHARM IO

The communication module can be connected to any HART 2-wire analog input channel wherein the HART loop can be powered from the built-in 24V supply.

Figure 1.5.4: Connection to CHARM IO

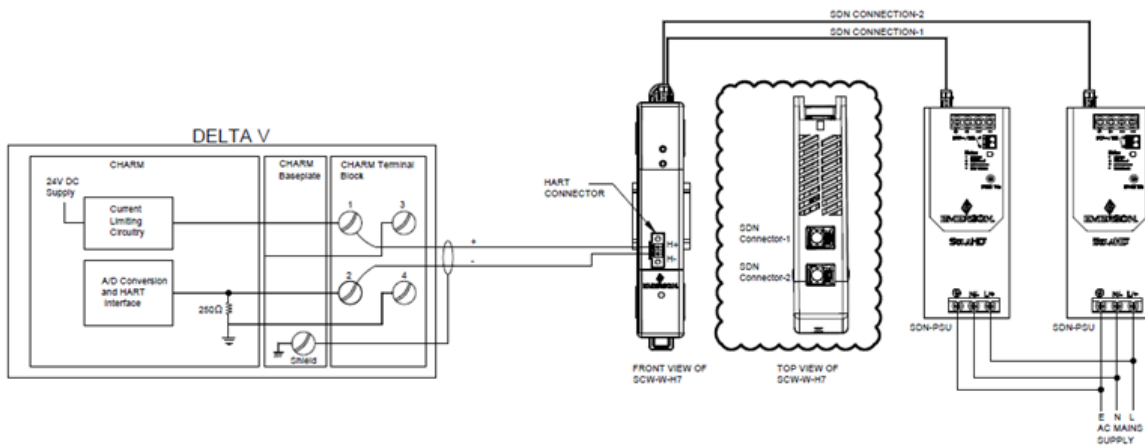

1.5.5 CONNECTING TO DELTAV TRADITIONAL IO

The communication module can be connected to a DeltaV Traditional IO module (S Series or M Series). The HART loop can be powered from the built-in 24V supply in the HART IO module.

Figure 1.5.5: Connection with DeltaV Traditional IO

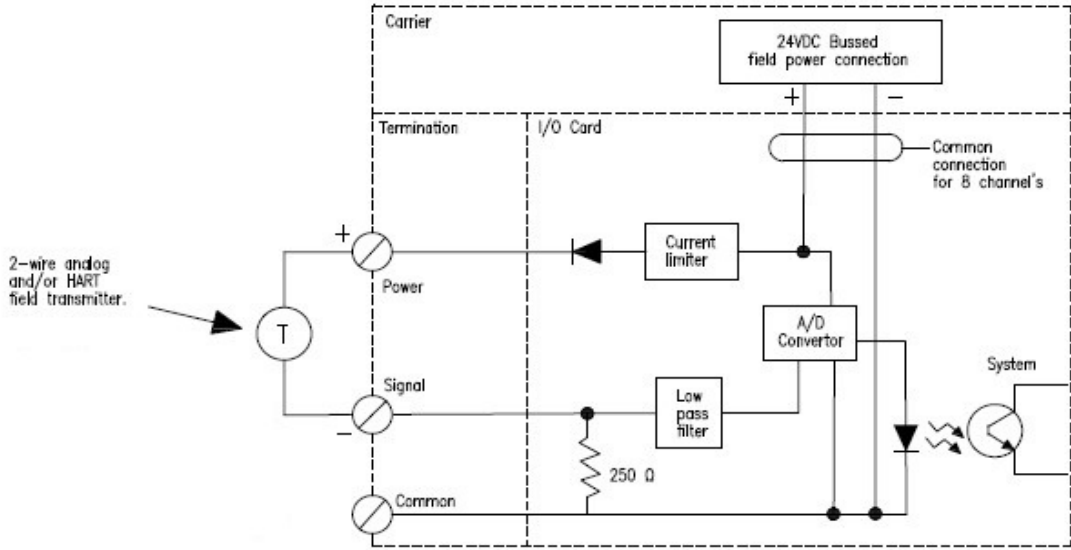

1.5.6 ESTABLISHING MULTI-DROP COMMUNICATION

Multi-dropping refers to the connection of several devices to a single communications transmission line. Communication between the host and the devices takes place digitally with the analog output of the transmitters deactivated. With the Field Communications protocol, up to 15 devices can be connected on a single twisted pair of wires or over leased phone lines. A Field Communicator can test, configure, and format a multi-dropped device in the same way as in a standard point-to-point installation. Each device is identified by a unique address (1–15) and responds to the commands defined in the HART protocol.

Figure 1.5.6A: Establishing multi-drop communication

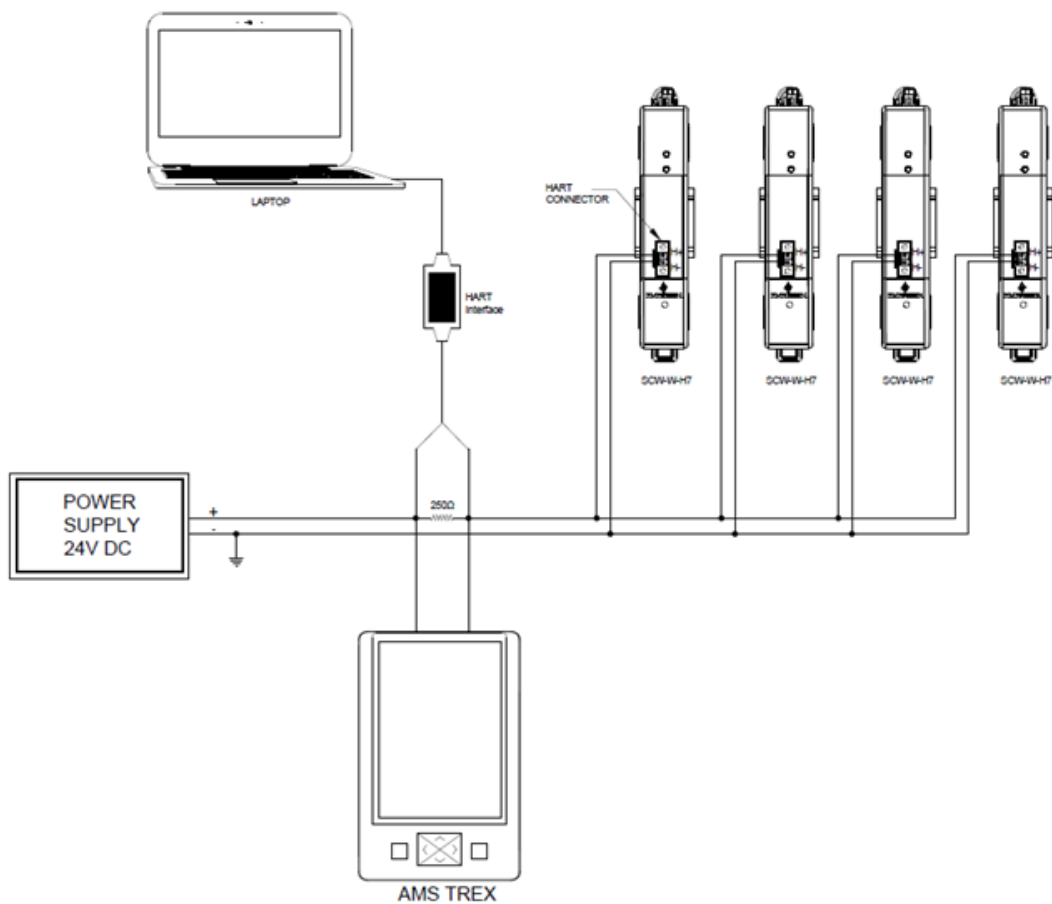

CHANGING A TRANSMITTER ADDRESS

To activate multi drop communication, the device poll address must be assigned a number from 1–63 for HART Revision 7. Each device in a multi dropped loop must have a unique poll address.

CHANGE TRANSMITTER ADDRESS USING AMS DEVICE MANAGER

1. Right click on the device and select Configure from the menu.
2. Select Manual setup.
3. In the HART tab, select the Change Polling Address button.

Figure 1.5.6B: Change Polling Address

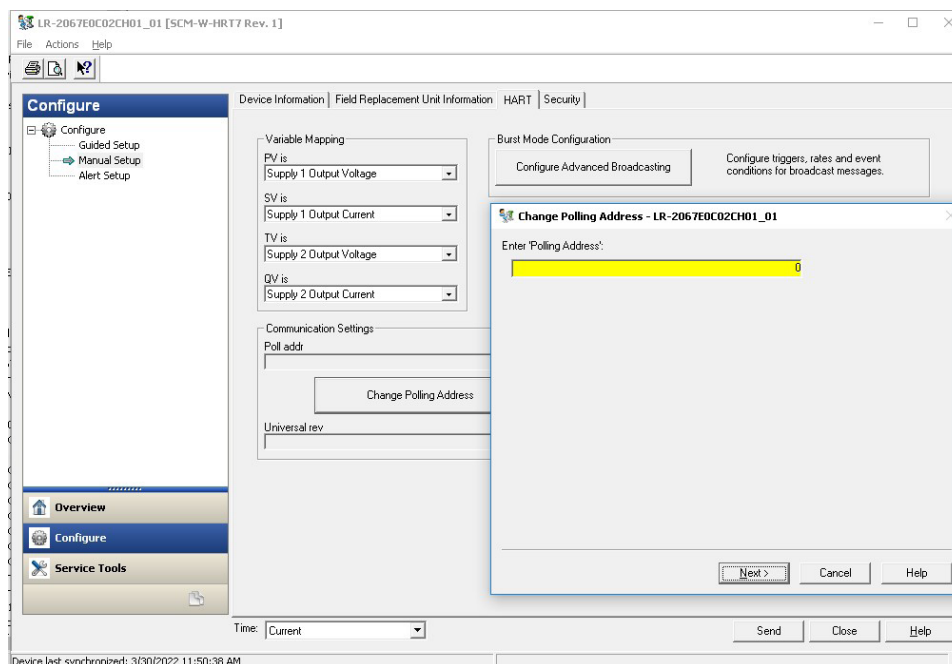

1.5.7 SPACING

The setup below shows the spacing of the SCM-W-HRT7 to the SDN-D Power Supplies. Please note that all devices are mounted on a standard DIN-rail.

Figure 1.5.7: Spacing

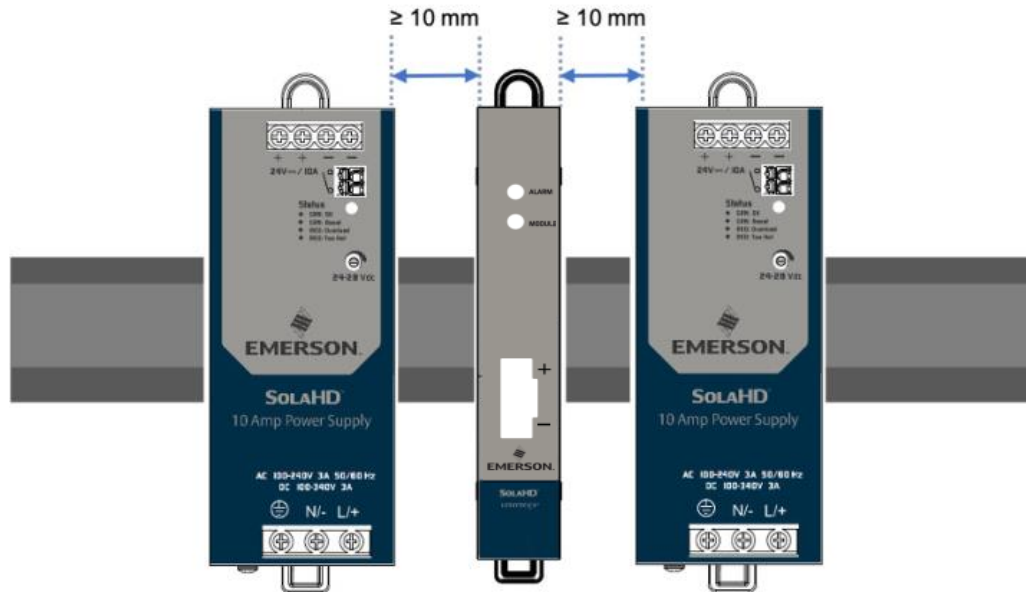

2. CONFIGURATION

2.1 OVERVIEW

To configure on the bench, required equipment includes a power supply and Field Communicator or AMS Device Manager. Connect the equipment as shown in Figure 2.2. Connect HART Communication leads at any termination point in the signal loop. To ensure successful HART Communication, a resistance of at least 250 ohms must be present between the device and the power supply. Connect the Field Communicator leads to the clips behind the power (+, -) terminals on the front of the device.

2.2 CONFIGURATION USING AMS TREX

The AMS Trex Field Communicator is a handheld device that exchanges information with the transmitter from the control room, the instrument site, or any wiring termination point in the loop. To facilitate communication, connect the Field Communicator, shown in this manual, in parallel with the transmitter (see [Figure 2.2](#)). Use the loop connection ports on the rear panel of the Field Communicator. The connections are non-polarized. Before connecting the Field Communicator in an explosive atmosphere make sure the instruments in the loop are installed in accordance with intrinsically safe or non-incendive field wiring practices. As stated in System readiness, it is critical that the latest DDs are loaded into the Field Communicator for optimal transmitter performance. Visit www.solahd.com to download latest DD library. Turn on the Field Communicator by pressing the ON/OFF key. The Field Communicator will search for a HART-compatible device and indicate when the connection is made. If the Field Communicator fails to connect, it indicates that no device was found. If this occurs, refer to [Troubleshooting](#).

Figure 2.2: Field Communicator Connections

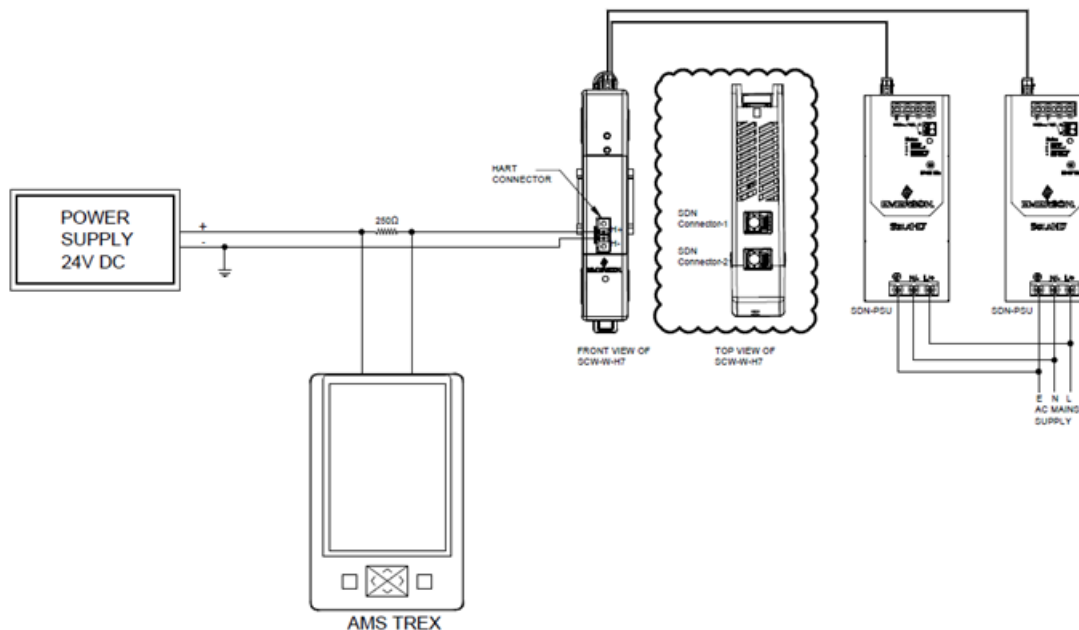

2.3 CONFIGURATION USING AMS DEVICE MANAGER

With an AMS Device Manager software package, you can commission and configure the device, monitor status and alerts, troubleshoot from the control room, perform advanced diagnostics, and automatically document activities with a single application. Full configuration capability with AMS Device Manager requires loading the most current Device Description (DD) for this device. Download the latest DD at www.solahd.com or Fieldcommgroup.org.

2.4 HART CONFIGURATION LOCK

The HART software lock prevents changes to the device configuration from all sources; all changes requested via HART by the Field Communicator, AMS Device manager will be rejected. The HART Lock can be enabled or disabled with a Field Communicator or AMS Device Manager.

PROCEDURE USING THE AMS DEVICE MANAGER

1. Right click on the device and select Configure.
2. Under Manual Setup, select the Security tab.
3. Select the Lock/Unlock button under HART Lock (Software) and follow the screen prompts.

2.5 BASIC CONFIGURATION OF COMMUNICATION MODULE

CONFIGURING THE DEVICE VARIABLES

Mapping HART variables using the Field Communicator The “Variable Mapping” menu displays the sequence of the process variables. Select the sequence below to change this configuration.

The device allows selection of the Primary Variable (PV), Secondary Variable (SV), Tertiary Variable (TV), and Quaternary Variable (QV). Variable choices are various parameters of the power supply units connected to either Channel 1 or Channel 2 of the communication module. The following table lists the selectable variables, ranges and units.

Table 2.5: Device Variables

Variable	Range	Units
Supply 1 Input Voltage	0–300	V
Supply 1 Output Voltage	0–32	V
Supply 1 Output Current	0–40	A
Supply 2 Input Voltage	0–300	V
Supply 2 Output Voltage	0–32	V
Supply 2 Output Current	0–40	A

MAPPING HART VARIABLES USING THE AMS DEVICE MANAGER

1. Right click on the device and select the Configure menu.
2. In the left navigation pane, select Manual Setup then on the HART tab.
3. Map each variable individually or use the Re-map Variables method to guide you through the re-mapping process.
4. Select Apply when complete.

Figure 2.5: Configure Device Variables

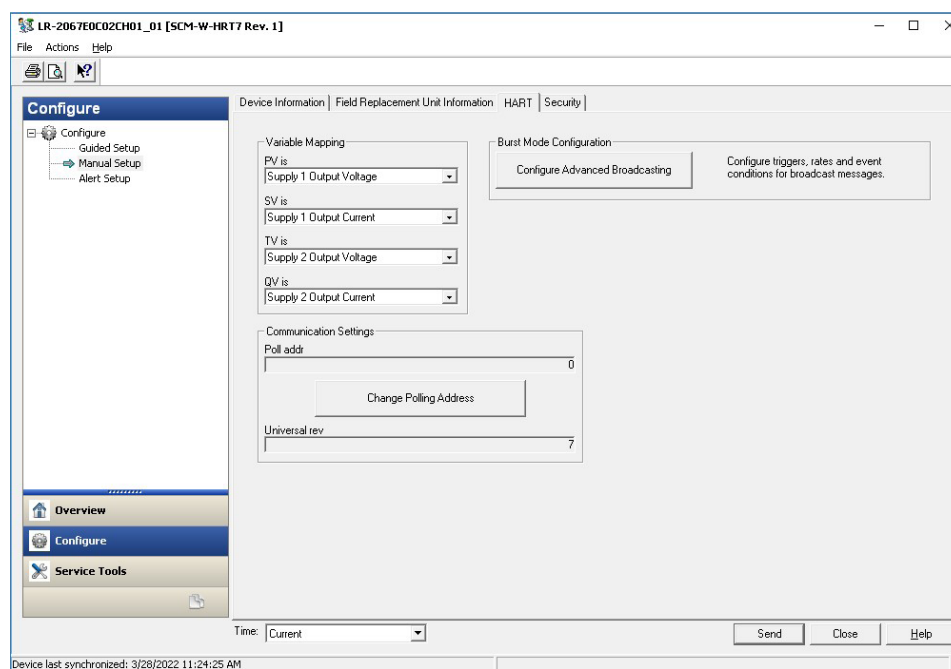

2.6 DEVICE INFORMATION CONFIGURATION

Access the device information variables online using the Field Communicator or other suitable communications device. The following is a list of device information variables, including device identifiers, factory-set configuration variables, and other information.

TAG, DATE, DESCRIPTOR, AND MESSAGE

The Tag, Date, Descriptor, and Message are parameters that provide device identification in large installations. The Tag variable is the easiest way to identify and distinguish between different device. It is used to label the devices electronically according to the requirements of the application. The defined Tag is automatically displayed when a HART-based communicator establishes contact with the device at power-up. The Tag is up to eight characters and the Long Tag (a parameter introduced with the HART 6 and 7 protocol) was extended to 32 characters long. Neither parameter has any impact on the primary variable readings of the transmitter, it is only for information.

The Date is a user-defined variable that provides a place to save the date of the last revision of configuration information. It has no impact on the operation of the device or the HART-based communicator.

The Descriptor variable provides a longer user-defined electronic label to assist with more specific device identification than is available with Tag. The Descriptor may be up to 16 characters long and has no impact on the operation of the device or the HART based communicator.

The Message variable provides the most specific user-defined means for identifying individual device in multi-transmitter environments. It allows for 32 characters of information and is stored with the other configuration data. The Message variable has no impact on the operation of the device or the HART-based communicator.

INPUT DEVICE INFORMATION USING AMS DEVICE MANAGER

1. Right click on the device and select Configure.
2. In the left navigation pane, select Manual Setup.
3. On the Device Tab there is a group box called identification. Enter the desired characters in the Tag, Date, Descriptor, and Message fields
4. Select Apply when complete.

Figure 2.6: Device Information

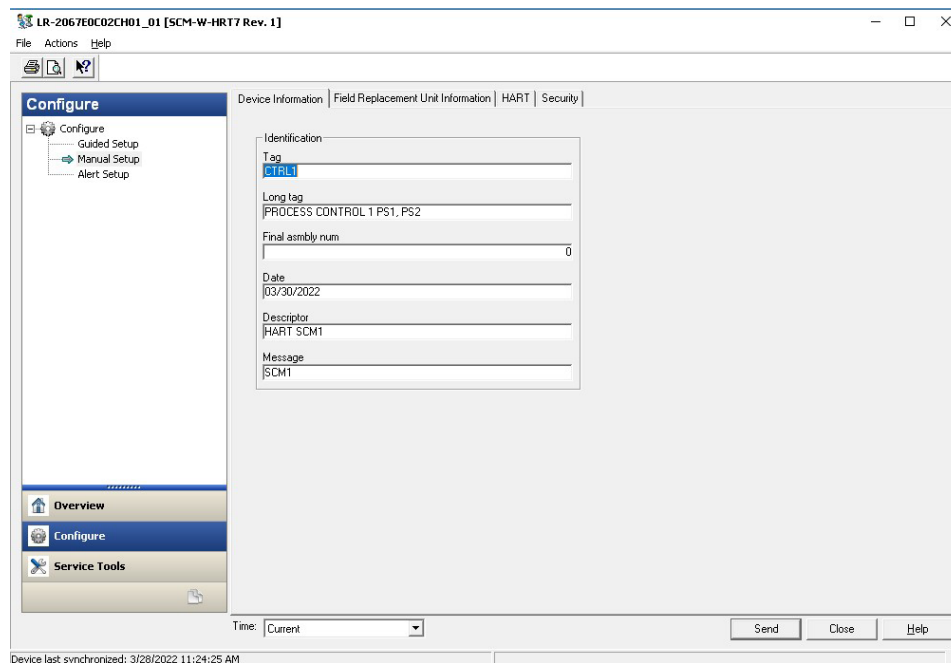

2.7 ALARM CONFIGURATION OF COMMUNICATION MODULE

User can configure below process alarms for each of the power supply modules connected with a configured limit.

- Output Current
- Supply Temperature

The communication module shall monitor configured alarms and raise alert message on the HART network if any parameter crosses its configured value. This would also be shown using LED indications.

CONFIGURING POWER SUPPLY ALARMS USING AMS DEVICE MANAGER

1. Right click on the device and select Overview.
2. Click on the respective wizard present under “Shortcuts” to perform the alarm configuration.

Figure 2.7: Alarm Configuration

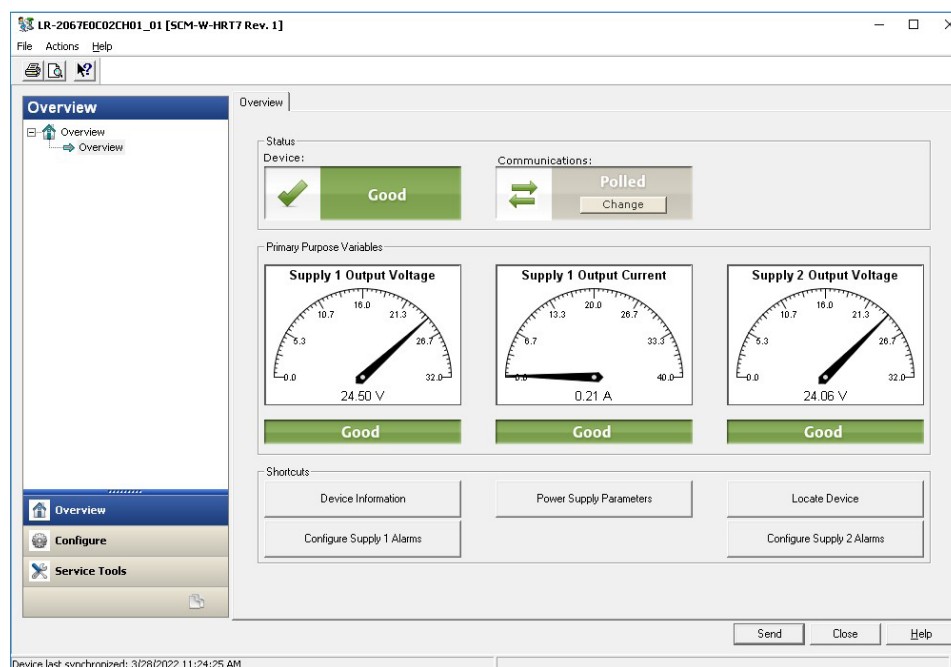

2.8 UNIT OF MEASUREMENT CONFIGURATION OF COMMUNICATION MODULE

Unit of measurement for the temperature values reported from the power supplies as well as the communication module can be configured.

CONFIGURING TEMPERATURE UNITS USING AMS DEVICE MANAGER

1. Right click on the device and select Configure.
2. Navigate to Guided Setup page and select the temperature unit of measurement.
3. Select Apply when complete.

3. MONITORING

3.1 ALERT MESSAGE MAPPING

This section outlines the most important alerts in the HART® command 48 Additional Status Field for the transmitter. The information in this section can be used by DeltaV for alert monitoring.

Table 3.1A displays the factory device variable and variable mapping indexes for the transmitter.

Table 3.1B to Table 3.1E shows a list of the most important alert messages that may be displayed in the AMS Device Manager and Field Communication together with the location of the Alert in the HART command 48 additional status field.

To view Active Alerts: From the *Home* screen, go to Service Tools → Active Alerts.

Table 3.1A: Device Variable Index

Device Variable	Index
0	Supply 1 Input Voltage
1	Supply 1 Output Voltage
2	Supply 1 Output Current
3	Supply 2 Input Voltage
4	Supply 2 Output Voltage
5	Supply 2 Output Current

Table 3.1B: Device Variable Index

Parameter	Accuracy
Supply 1 Input Voltage	+/-5.0%
Supply 1 Output Current	+/-2.5%
Supply 1 Output Voltage	+/-2.0%
Supply 2 Input Voltage	+/-5.0%
Supply 2 Output Current	+/-2.5%
Supply 2 Output Voltage	+/-2.0%

NOTES:

- The accuracy defined in the table above is valid over the entire operating input, load, Vout range and 0–60°C (unless specified otherwise)
- P1, P2 Temperature (power supply internal ambient temperature) accuracy at > 50°C
- Iout accuracy at > 20% of max. operating load

Table 3.1C: Failure Alerts (F:)

Message	Additional Status ⁽¹⁾	Description
Supply 1 Short Circuit Protection Active	Byte 3:: Bit 6	Short circuit fault occurred at the output of the power supply. This is triggered when the load current is greater than 150% of the rated load.
Supply 1 Output Overvoltage Protection Active	Byte 3:: Bit 4	The output voltage of the power supply is greater than 32V for SDN10 and 35V for SDN20.
Supply 1 Over Temperature Protection Active	Byte 3:: Bit 1	Internal temperature of the power supply exceeding safe operating levels. This occurs when the main transformer temperature exceeds 125°C.
Supply 2 Short Circuit Protection Active	Byte 4:: Bit 6	Short circuit fault occurred at the output of the power supply. This is triggered when the load current is greater than 150% of the rated load.
Supply 2 Output Overvoltage Protection Active	Byte 4:: Bit 4	The output voltage of the power supply is greater than 32V for SDN10 and 35V for SDN20.
Supply 2 Over Temperature Protection Active	Byte 4:: Bit 1	Internal temperature of the power supply exceeding safe operating levels. This occurs when the main transformer temperature exceeds 125°C.

(1) Location of the Alert in the HART command 48 Status field.

Table 3.1D: Maintenance Alerts (M:)

Message	Additional Status ⁽¹⁾	Description
Supply 1 High Output Current Alarm	Byte 5:: Bit 0	Output current from the power supply exceeding the configured alarm limit.
Supply 2 High Output Current Alarm	Byte 5:: Bit 1	Output current from the power supply exceeding the configured alarm limit.
Supply 1 High Temperature Alarm	Byte 5:: Bit 2	Power supply temperature exceeding the configured alarm limit.
Supply 2 High Temperature Alarm	Byte 5:: Bit 3	Power supply temperature exceeding the configured alarm limit.

(1) Location of the Alert in the HART command 48 Status field.

Table 3.1E: No Effect (N:)

Message	Additional Status ⁽¹⁾	Description
NV Integrity Error	Byte 0:: Bit 0	The nonvolatile memory was defaulted which results in factory default configuration for the device.

(1) Location of the Alert in the HART command 48 Status field.

3.2 POWER SUPPLY PARAMETERS AND MAXIMUM VALUES

Access power supply diagnostic parameters, error counts and maximum values plus timestamps for each connected power supply. The information displayed does not automatically refresh. Select the Refresh Data button for latest values.

Table 3.2: Power Supply Parameters

Power Supply Parameter	Long Description
Temperature	Internal temperature of power supply
Turn On Time	Time since last power cycle
Total On Time	Total power supply operational time
DC On Cycles	Number of times DC output has been cycled
EC - SCP	Error count – Short Circuit Protection counter
EC - OVP	Error count – Over Voltage Protection counter
EC - PBoost	Error count – Power Boost counter
EC - InputApp	Error count – Input Voltage Applied counter
EC - OTP	Error count – Over Temperature Protection counter

PROCEDURE USING THE AMS DEVICE MANAGER

- 1. Right click on the device and select Overview from the menu.
- 2. Under “Shortcuts” select Power Supply Parameters

Figure 3.2A: Power Supply Parameters

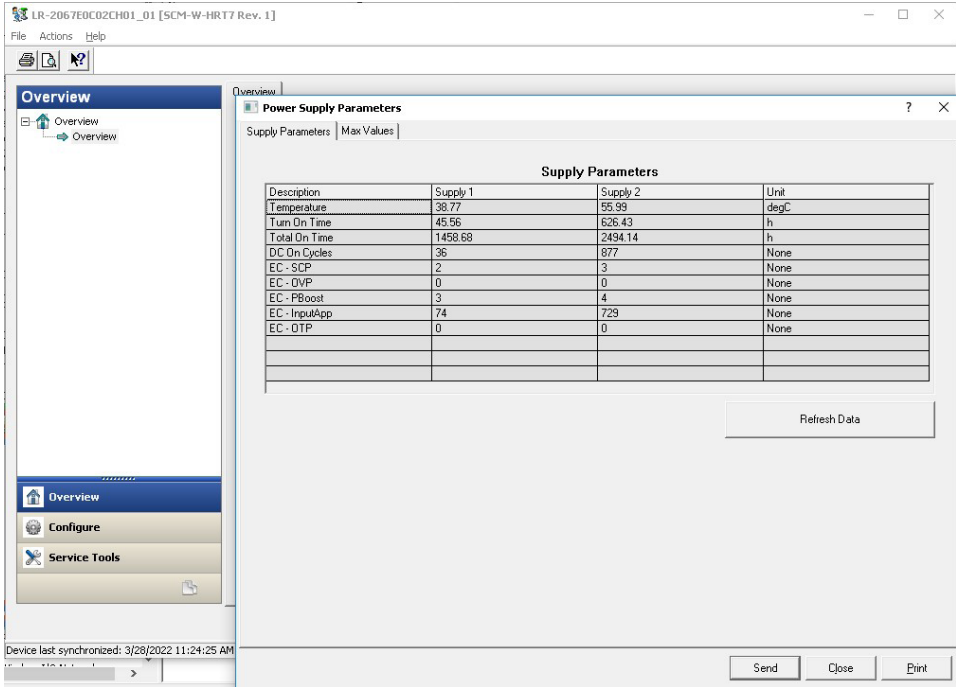

Figure 3.2B: Max Values

The screenshot shows a software window titled "Power Supply Parameters" with a sub-tab "Max Values". The window contains a table with the following data:

Description	Supply 1	Supply 2	Unit	Supply 1 Timestamp (h)	Supply 2 Timestamp (h)
Max Vin	180.36	199.64	V	914.80	1334.25
Max Vout	26.92	27.49	V	1410.64	2360.79
Max Iout	17.41	17.46	A	1433.01	2407.72
Max Temp	55.46	56.83	degC	1435.66	2492.54

Below the table is a "Refresh Data" button. At the bottom of the window are three buttons: "Send", "Close", and "Print".

3.3 SCM TEMPERATURE VALUE

Access the internal temperature of the SCM. The value displayed does not automatically refresh. Select the Refresh Temperature Data button for latest value.

PROCEDURE USING THE AMS DEVICE MANAGER

1. Right click on the device and select Configure from the menu.
2. Select Manual Setup.
3. Select Field Replacement Unit Information.

Figure 3.3 SCM Temperature

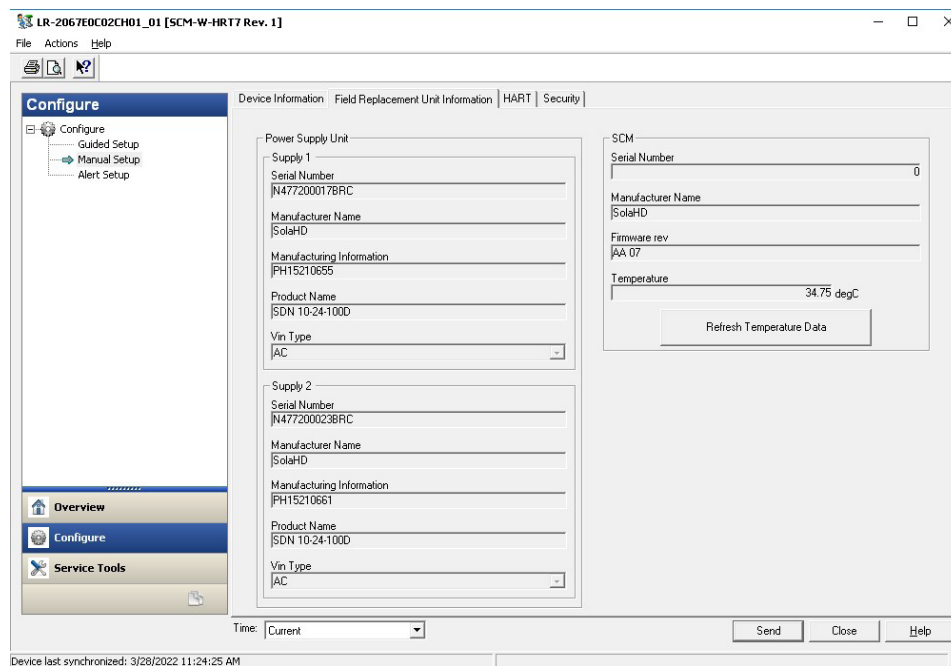

3.4 REVISION INFORMATION

The revision of the SCM, Power Supply and Device Description file can be displayed.

PROCEDURE USING THE AMS DEVICE MANAGER

1. Right click on the device and select Overview.
2. Select Device Information.
3. Select Revisions Tab.

Figure 3.4: Revision Information

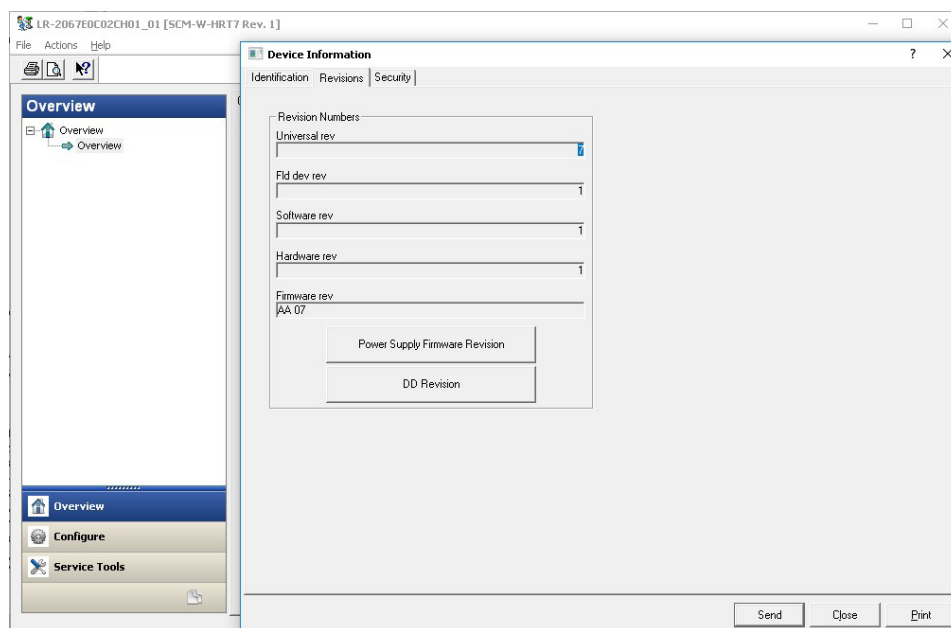

4. TROUBLESHOOTING

HART LOOP TROUBLESHOOTING

Symptom	Probable Cause	Corrective Action
No loop current	Communication Module not powered	Check if the communication module is connected properly to the power supply using the I2C communication cable.
	HART connection issues	Check the loop power supply (24V), polarity of connections, wiring and loop resistance.
	Electronics Failure	Replace the communication module
Current loop stuck at 4mA	Communication Module Set in Multidrop Mode	Configure the polling address to 0 and set loop current mode active to take the module out of multidrop mode
	Primary variable set to lowest possible value	Check the power supply parameter assigned to the primary variable and make sure that its value is correct in the range. Follow the power supply troubleshooting procedures.

AMS DEVICE MANAGER DISPLAY

Symptom	Probable Cause	Corrective Action
Gauges show value as NaN with Bad Status	The device variable associated with the dynamic variable being displayed has no value to be displayed	Check if the power supply related to the dynamic variable is connected. If not, use AMS-DM to remap the dynamic variables associated with the power supply channel which is connected.
AMS Device Manager not able to scan the device (Communication Module).	Communication Module not powered	Check if the communication module is connected properly to the power supply using the I2C communication cable.
	Hart connection issues	Check the loop power supply (24V), polarity of connections, integrity of wiring, loop resistance and possible noise issues.
	Polling address	Check if AMS-DM is set to scan multi drop devices in case the communication module is configured at non-zero polling address

LED INDICATIONS

Symptom	Probable Cause	Corrective Action(s)
Both LED Indicators OFF	Communication Module is not powered	Check if the communication module is connected properly to the power supply using the I2C communication cable.
Module Status LED - Blinking Red	Incompatible SDN-D power supply connected	Use supported set of power supply modules with right firmware revisions
Alarm Status LED - Blinking Green	Communication Module is reporting an active Device Alert (see Device Alerts table) condition belonging to the "Maintenance" classification	Using AMS-DM, get the details on the specific alert condition and its associated corrective action. Also see the "Device Alerts" section below.
Alarm Status LED - Blinking Red	Communication Module is reporting an active Device Alert (see Device Alerts table) condition belonging to the "Failure" classification	Using AMS-DM, get the details on the specific alert condition and its associated corrective action. Also see the "Device Alerts" section below.
Alarm Status LED - Blinking Amber	Communication Module is reporting an active Process Alarm (see Process Alarms table) condition belonging to the "Maintenance" classification	Using AMS-DM, get the details on the specific alert condition and its associated corrective action. Also see the "Process Alarm" section below.

DEVICE ALERTS

Device Alert	Probable Cause	Corrective Action(s)
Supply X ¹ Short Circuit Protection Active	Short circuit fault occurred at the output of the power supply. This is triggered when the load current is greater than 150% of the rated load.	Check the load associated with the power supply. If the load is more than the power supply capacity, either distribute the load with another power supply or opt for power supply having higher capacity.
Supply X ¹ Output Overvoltage Protection Active	The output voltage of the power supply is greater than 32V for SDN10 and 35V for SDN20.	Check power supply DC output wiring connections, try to adjust the voltage and replace power supply if necessary.
Supply X ¹ Over Temperature Protection Active	Internal temperature of the power supply exceeding safe operating levels. This occurs when the main transformer temperature exceeds 125°C.	<p>Check the power supply load, if nearing or crossing the load capacity, distribute the load among multiple supplies.</p> <p>Check ventilation and ambient conditions for the power supply.</p> <p>Replace the power supply if necessary.</p>
NV Integrity Error	The nonvolatile memory was defaulted which will result in factory default configuration for the device.	<p>Perform a "Master Reset" of the communication module using AMS Device Manager or power cycle the communications module by removing the cables coming from SDN-D power supplies and plugging them back in.</p> <p>If alert condition persists, replace the communication module.</p>

Note ¹: X refers to power supply 1 or 2.

PROCESS ALARMS

Process Alarm	Probable Cause	Corrective Action(s)
Supply X ¹ High Output Current Alarm	Output current from the power supply is exceeding the configured alarm limit.	<p>Check the power supply load. If nearing or crossing the load capacity, distribute the load among multiple supplies.</p> <hr/> <p>Increase the high current alarm limit using AMS Device Manager</p>
Supply X ¹ High Temperature Alarm	Power supply temperature is exceeding the configured alarm limit.	<p>Check the power supply load. If nearing or crossing the load capacity, distribute the load among multiple supplies.</p> <hr/> <p>Check ventilation and ambient conditions for the power supply.</p> <hr/> <p>Increase the high temperature alarm limit using AMS Device Manager.</p>

Note ¹: X refers to power supply 1 or 2.

4.1 MASTER RESET

Perform a restart of the SCM by using the Master Reset function. This is a soft restart and will not erase any configuration data.

PROCEDURE USING THE AMS DEVICE MANAGER

1. Right click on the device and select Service Tools.
2. Select Maintenance.

Figure 4.1: Master Reset

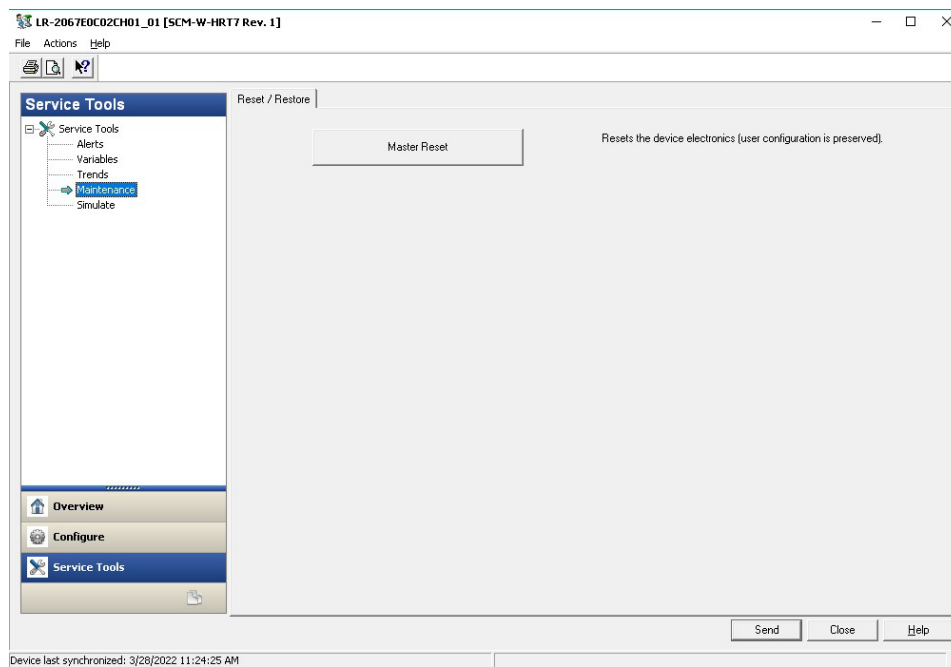

APPENDIX A: FIELD COMMUNICATOR MENU TREE

Figure Appendix A1: Overview

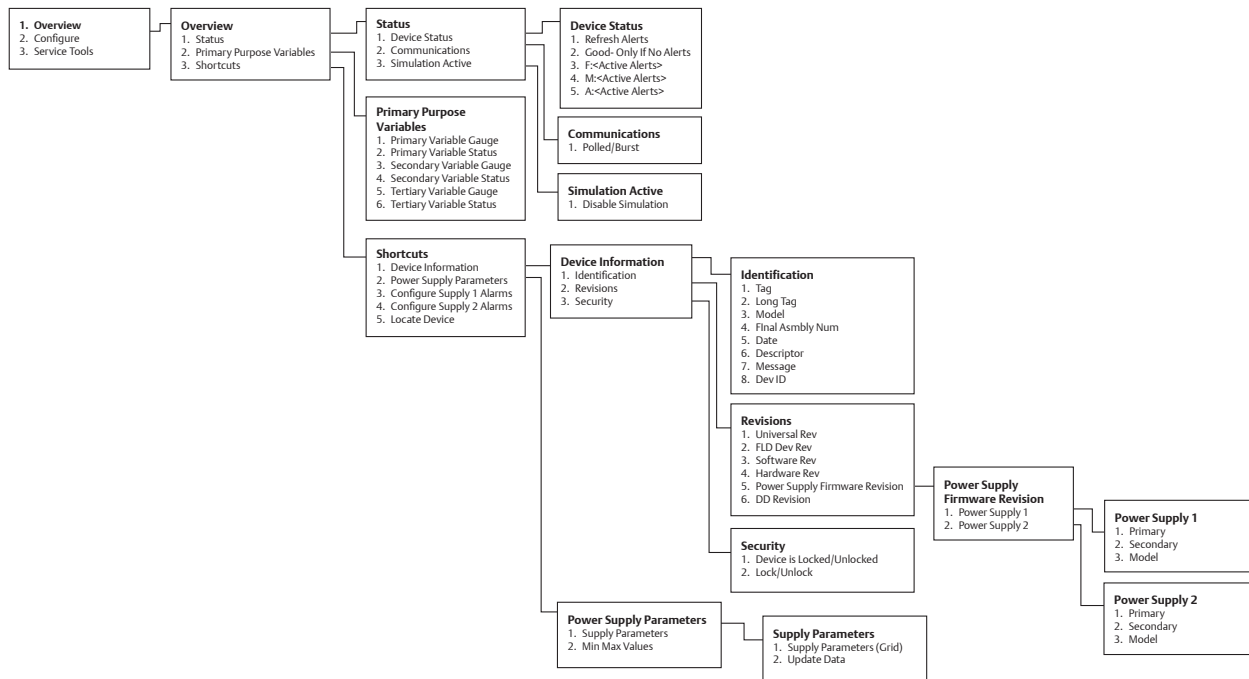

Figure Appendix A2: Configure

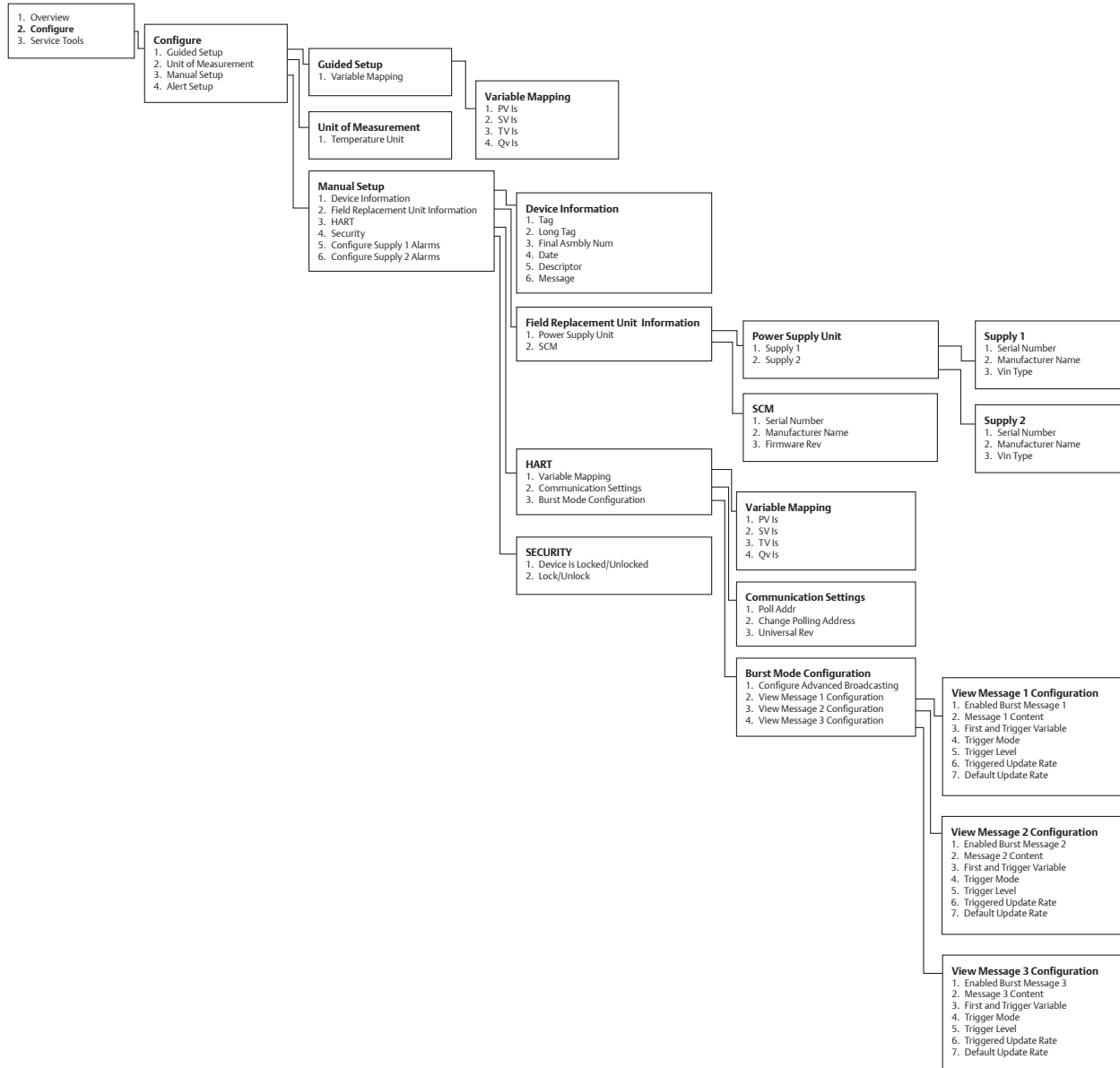
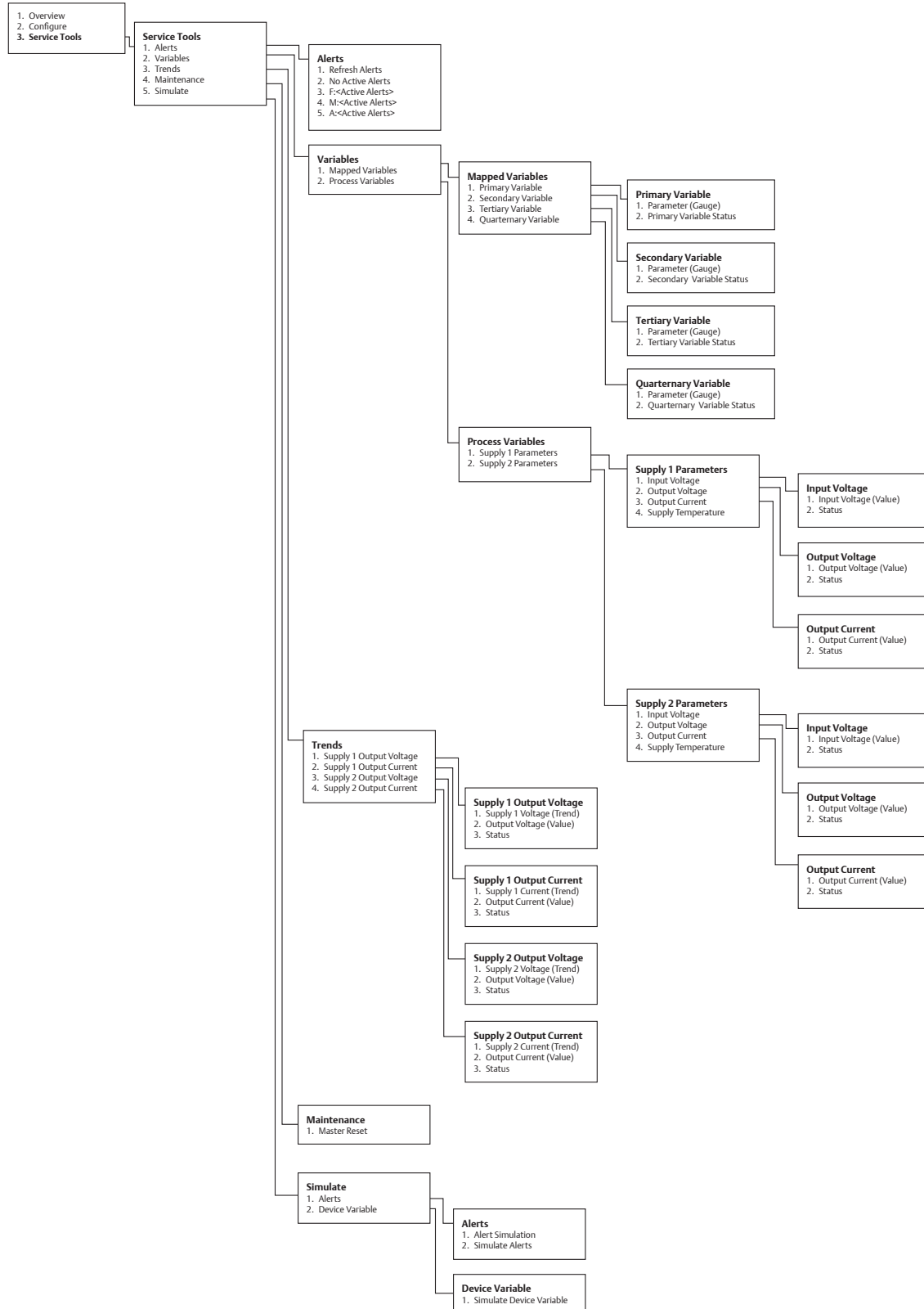

Figure Appendix A3: Overview



The information in this manual is provided as a guide for installation, operation, and maintenance. It does not affect or exceed our obligations under the Terms and Conditions of Sale.

Note that unit specifications are subject to change without notice.

TECHNICAL SUPPORT

Website: www.solahd.com

Technical Support E-Mail: solahd.technicalservices@emerson.com

Toll-Free: (800) 377-4384

USA: (847) 268-6651

WARRANTY

Please see the “Terms & Conditions of Sale” document within the UPS packaging.

While every precaution has been taken to ensure accuracy and completeness in this manual, Appleton Grp LLC d/b/a Appleton Group assumes no responsibility, and disclaims all liability for damages resulting from use of this information or for any errors or omissions.

HART Revision 7 Communication Module (SCM-W-HRT7)

A272-366 Rev. 1.2_11/2023

The Emerson logo is a trademark and service mark of Emerson Electric Co.
Appleton Grp LLC d/b/a Appleton Group. SolaHD is a registered trademark of Appleton Grp LLC.
All other marks are the property of their respective owners. © 2023 Emerson Electric Co. All rights reserved.

United States (Headquarters)

Appleton Grp LLC
9377 W. Higgins Road
Rosemont, IL 60018
United States
T +1 800 621 1506

Australia Sales Office

Bayswater, Victoria
T +61 3 9721 0348

Korea Sales Office

Seoul
T +82 2 3483 1555

Europe

ATX SAS
Espace Industriel Nord
35, rue André Durouchez,
CS 98017
80084 Amiens Cedex 2
France
T +33 3 2254 1390

China Sales Office

Shanghai
T +86 21 3338 7000

Canada

EGS Electrical Group Canada
Ltd.
99 Union Street
Elmira ON, N3B 3L7
Canada
T +1 888 765 2226

Middle East Sales Office

Dammam, Saudi Arabia
T +966 13 510 3702

Asia Pacific

EGS Private Ltd.
Block 4008, Ang Mo Kio
Ave 10,
#04-16 TechPlace 1,
Singapore 569625
T +65 6556 1100

Chile Sales Office

Las Condes
T +56 2928 4819

Latin America

EGS Comercializadora
Mexico S de RL de CV
Calle 10 N°145 Piso 3
Col. San Pedro de los Pinos
Del. Álvaro Obregon
Ciudad de México. 01180
T +52 55 5809 5049

India Sales Office

Chennai
T +91 44 3919 7300

SOLAHD

