

Flexim FLUXUS F721, F722 Ultrasonic Flowmeter

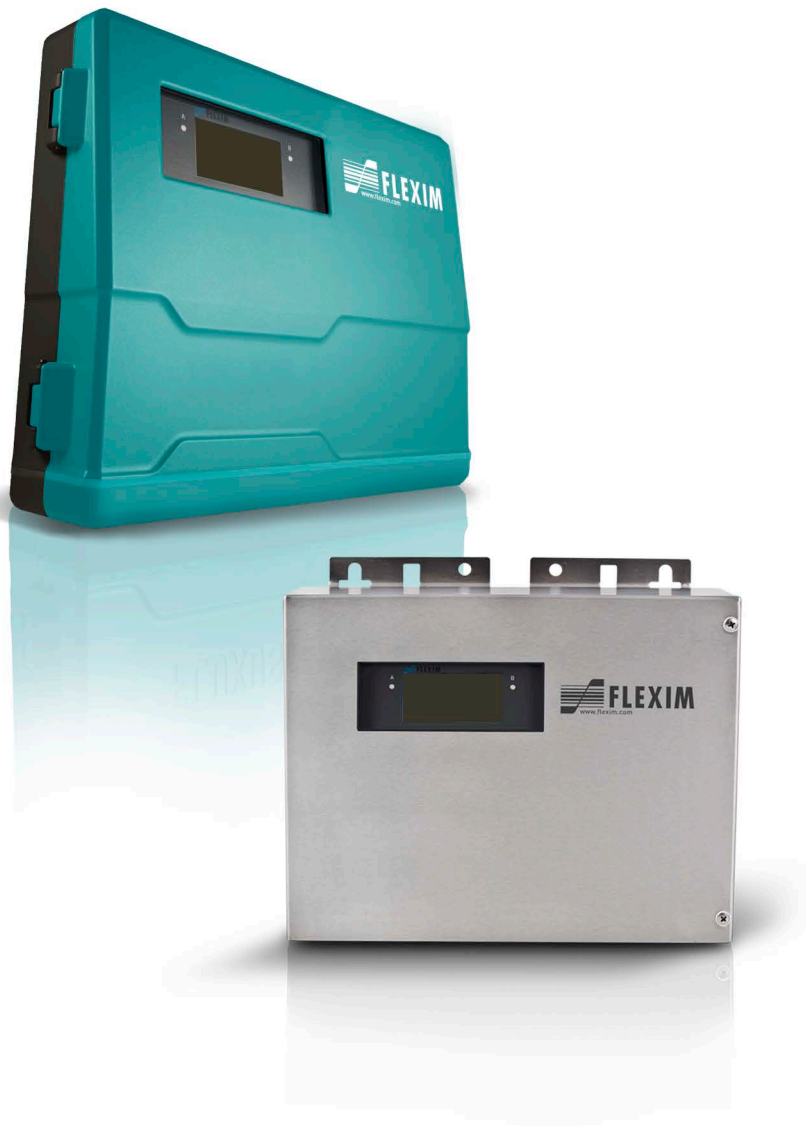



Table of contents

1	Introduction	7
2	Safety instructions	8
2.1	General safety instructions	8
2.2	Intended use	8
2.3	Not intended use	9
2.4	Safety instructions for the user	9
2.5	Safety instructions for the operator	9
2.6	Safety instructions for electrical work	9
2.7	Safety instructions for transport	10
2.8	Recommended procedure in hazardous situations	10
3	General principles	11
3.1	Measurement principle	11
3.2	Measurement arrangements	15
3.3	Acoustic penetration	17
3.4	Undisturbed flow profile	18
4	Product description	21
4.1	Measuring system	21
4.2	Handling concept	21
4.3	Display	23
4.4	Keyboard	24
5	Transport and storage	25
5.1	Transport	25
5.2	Storage	25
6	Mounting	26
6.1	Transmitter	27
6.2	Transducers	32
6.3	Temperature probe	66
7	Connection	70
7.1	Transducers	71
7.2	Power supply	83
7.3	Outputs	85
7.4	Inputs	88
7.5	Temperature probe	90
7.6	Service interfaces	94
8	Start-up	97
8.1	Start-up settings	98
8.2	Switching on	98
8.3	Status indications	99
8.4	Language	99
8.5	Initialization	100
8.6	Date and time	100
8.7	Information regarding the transmitter	101

9	Measurement	102
9.1	Parameter input	102
9.2	Configuration of an output	110
9.3	Start of measurement	118
9.4	Display during the measurement	120
9.5	Execution of special functions	124
9.6	Stop of measurement	126
10	Troubleshooting	127
10.1	Problems with the measurement	128
10.2	Measuring point selection	129
10.3	Maximum acoustic contact	129
10.4	Application-specific problems	129
10.5	Significant deviations of the measured values	130
10.6	Problems with the totalizers	130
10.7	Problems during the thermal energy rate measurement	130
11	Maintenance and cleaning	131
11.1	Maintenance	132
11.2	Cleaning	132
11.3	Calibration	132
11.4	Firmware update	132
12	Dismounting and disposal	133
12.1	Dismounting	133
12.2	Disposal	133
13	User modes	134
13.1	StandardUser mode	135
13.2	ExpertUser mode	139
13.3	SuperUser mode and SuperUser ext. mode	143
14	Outputs	152
14.1	Configuration of a digital output as binary output	152
14.2	Configuration of a digital output as pulse output	155
14.3	Configuration of a digital output as frequency output	158
15	Inputs	161
15.1	Configuration of an input	161
15.2	Assignment of an input	166
16	Data logger	167
16.1	Configuration of the data logger	167
16.2	Deletion of the data logger	171
16.3	Information regarding the data logger	171
17	Data transmission	172
17.1	Service interfaces	172
17.2	Process interface	173

18	Advanced functions	174
18.1	Totalizers	174
18.2	FastFood mode	177
18.3	Diagnosis with the help of the snap function	178
18.4	Modification of the limit for the inner pipe diameter	179
18.5	Remote functions	180
18.6	Event triggers	182
18.7	Event log	187
19	Settings	188
19.1	Dialogs and menus	188
19.2	Measurement modes	190
19.3	Measurement settings	191
19.4	Units of measurement	192
19.5	Material and fluid scroll list	192
19.6	Working with parameter records	193
19.7	Contrast settings	194
19.8	HotCodes	194
19.9	Key lock	195
20	Thermal energy rate measurement (option)	197
20.1	Calculation of the thermal energy rate	197
20.2	Definition of the physical quantity and the unit of measurement	198
20.3	Application and transducer positioning	198
20.4	Assignment of the temperature inputs	199
20.5	Two independent thermal energy rate measurements	199

Annex

A	Menu structure	201
B	Units of measurement	220
C	Reference	224
D	Legal information – open source licenses	229
E	Conformity declarations	233



1 Introduction

This operating instruction has been written for users operating the ultrasonic flowmeter FLUXUS. It contains important information about the measuring equipment, how to handle it correctly, and how to avoid damages. Read the safety instructions carefully. Make sure you have read and understood this operating instruction before using the measuring equipment.

Any work on the measuring equipment has to be carried out by authorized and qualified personnel in order to detect and avoid possible risks and dangers.

Presentation of warnings

This operating instruction contains warnings marked as follows:

Danger!	
	Type and source of danger danger with high level of risk, which, if not avoided, can lead to death or serious injuries → measures of prevention
Warning!	
	Type and source of danger danger with medium level of risk, which, if not avoided, can lead to serious or moderate injuries → measures of prevention
Caution!	
	Type and source of danger danger with low level of risk, which, if not avoided, can lead to moderate or minor injuries → measures of prevention
Important!	
This text contains important information which should be observed in order to avoid material damage.	
Notice!	
This text contains important information about the handling of the measuring equipment.	

Storage of the operating instruction

The operating instruction must permanently be available at the place where the measuring equipment is used. It must be available to the user at all times.

User comments

All reasonable effort has been made to ensure the correctness of the content of this operating instruction. If you, however, find some erroneous information or miss information, please inform us.

We will be grateful for any suggestions and comments regarding the concept and your experience when working with the measuring equipment. If you have any suggestions about improving the documentation and particularly this operating instruction, please let us know so that we can consider your comments for future reprints.

Copyright

The contents of this operating instruction are subject to changes without prior notice. All rights reserved. No part of this operating instruction may be reproduced in any form without FLEXIM's written permission.

2 Safety instructions







2.1 General safety instructions

Prior to any work, read the operating instruction carefully and in full.

Failure to comply with the instructions, in particular with the safety instructions, poses a risk to health and can lead to material damages. For further information, contact FLEXIM.

During installation and operation of the measuring equipment, observe the ambient and installation conditions specified in the documentation.

Explanation of symbols on the transmitter and accessories:

symbol	meaning
	direct current
	connection for equipotential bonding/grounding
	protective ground terminal
	Electric devices and batteries must be disposed of separately. If necessary, additional hazardous substances are indicated for disposal.
	Warning! Electric shock possible.
	Observe the operating instruction.
	Warning! Observe the safety instructions in the manufacturer's documentation.

The measuring equipment has to be checked for proper condition and operational safety before each use. If troubles or damages have occurred during installation or operation of the measuring equipment, please inform FLEXIM.

It is not allowed to make unauthorized modifications or alterations to the measuring equipment.

If the measuring point is within an explosive atmosphere, the danger zone and present explosive atmosphere have to be determined. The transmitter, transducers and accessories have to be appropriate and approved for the conditions within the corresponding zone.

Personnel has to be suitably trained and experienced for the work.

Observe the "Safety instructions for the use in explosive atmospheres" (see document SIFLUXUS). Observe the instructions for hazardous substances and the respective safety data sheets. Observe the regulations for the disposal of electrical equipment.

2.2 Intended use

The measuring equipment is intended for the measurement of fluid properties in closed pipes. By means of connected transducers, the transit times of the ultrasonic signals in the fluid and the pipe as well as other related properties, such as temperature and pressure, are measured and evaluated.

The transmitter uses these values to calculate the sought quantities, e.g., volumetric flow rate, mass flow rate and thermal energy. Through comparison with the values stored in the transmitter further physical quantities can be determined. The physical quantities are provided via configurable outputs and the display.

- All instructions of this operating instruction have to be observed to ensure intended use.
- Any use beyond or other than the intended use is not covered by warranty and can present a danger. Any damage arising from not intended use shall be solely the liability of the operator or user.
- The measurement is carried out without direct contact to the fluid in the pipe. The flow profile is not influenced.
- The transducers are fixed to the pipe using the supplied transducer mounting fixture.
- If an extension cable is required to connect the transducers to the transmitter, a junction box can be used (optional). Observe the safety instructions in the operating instruction. For the technical data of the junction box, see technical specification.
- Observe the operating conditions, e.g., environment, voltage ranges. For the technical data of the transmitter, transducers and accessories, see technical specification.

2.3 Not intended use

Not intended use in terms of a misuse means:

- any work on the measuring equipment without observing all instructions in this operating instruction
- use of transmitter, transducer and accessory combinations not intended by FLEXIM
- installation of the transmitter, transducers and accessories in explosive atmospheres they are not approved for
- any work on the measuring equipment (e.g., installation, dismantling, connection, start-up, operation, service and maintenance) carried out by unauthorized and untrained personnel
- storage, installation and operation of the measuring equipment outside the specified ambient conditions (see technical specification)

2.4 Safety instructions for the user

Any work on the transmitter has to be carried out by authorized and qualified personnel only. Observe the safety instructions in the operating instruction. For the technical data of transmitter, transducers and accessories, see technical specification.

- Observe the safety and accident prevention regulations applicable on the site of operation.
- Only use the supplied mounting fixtures and transducers as well as the intended accessories.
- Always wear the required personal protective equipment.

2.5 Safety instructions for the operator

- The operator shall qualify the personnel to perform their assigned tasks. The operator shall provide the required personal protective equipment and oblige the personnel to wear it. It is recommended to risk assess the workplace.
- Besides the safety instructions in this operating instruction, the health, safety and environment regulations applicable for the range of application of the transmitter, transducers and accessories have to be observed.
- With the exceptions stated in chapter 11, the measuring equipment is maintenance-free. Any components and spare parts may only be replaced by FLEXIM. The operator shall carry out periodic checks for changes or damages that can present a danger. For further information, contact FLEXIM.
- Observe the specifications for the installation and connection of the transmitter, transducers and accessories.

2.6 Safety instructions for electrical work

- Prior to any work on the transmitter (e.g., installation, dismantling, connection, service and maintenance), the transmitter has to be disconnected from the power supply. It is not sufficient to remove the internal fuse of the instrument.
- Electrical work may only be carried out if there is enough space.
- Open the transmitter in safe ambient conditions only (e.g., air humidity < 90 %, no conductive pollution, no explosive atmosphere). Otherwise, additional protective measures have to be taken.
- The degree of protection of the transmitter is only ensured if all cables are tightly fitted using cable glands and the housing is firmly screwed.
- The condition and tight fit of the electrical connections have to be checked at regular intervals.
- When connecting the transmitter to the power supply, an appropriate equipment switch according to IEC 60947-1 and IEC 60947-3 has to be installed as disconnecting device. The equipment switch has to disconnect all live wires. The

ground conductor connection must not be interrupted. The equipment switch has to be easily accessible and clearly marked as a disconnecting device for the transmitter. It should be located near the transmitter. If the transmitter is used in an explosive atmosphere, the equipment switch has to be installed outside the explosive atmosphere. If this is not possible, it has to be installed in the least hazardous area.

- The connection may only be made to networks up to overvoltage category II. When connecting the inputs and outputs as well as the power supply, observe the installation instructions, in particular the terminal assignment.
- The front plate must not be removed. The transmitter does not contain any components to be maintained by the user. For repair and service work, please contact FLEXIM.
- Observe the safety and accident prevention regulations for electrical systems and equipment.

Fig. 2.1: Transmitter

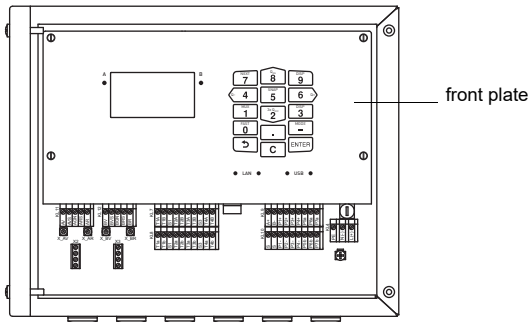

2.7 Safety instructions for transport

Caution!



Warning of injuries due to falling objects

- Unsecured and falling objects can lead to severe injuries.
- Secure all components against falling during transport.
 - Wear the required personal protective equipment.
 - Observe the applicable rules.

- If you detect a transport damage when unpacking the delivery, please contact the supplier or FLEXIM immediately.
- The transmitter is a sensitive electronic measuring instrument. Avoid shocks or impacts.
- Handle the transducer cable with care. Avoid excessive bending or buckling. Observe the ambient conditions.
- Select a solid surface to put the transmitter, transducers and accessories on.
- The transmitter, transducers and accessories have to be properly packed for transport:
 - Use, if possible, the original packaging by FLEXIM or an equivalent cardboard box.
 - Position the transmitter, transducers and accessories in the middle of the cardboard box.
 - Fill any voids with appropriate packaging material (e.g., paper, foam, bubble wrap).
 - Protect the cardboard box against humidity.

2.8 Recommended procedure in hazardous situations

Fire fighting measures

- If possible, disconnect the transmitter from the power supply.
- Prior to extinguishing, protect any electrical parts that are not affected by the fire (e.g., using a cover).
- Select a suitable extinguishing agent. Avoid, if possible, conductive extinguishing agents.
- Observe the applicable minimum distances. The minimum distances differ depending on the used extinguishing agent.

3 General principles

In the ultrasonic flow measurement, the flow velocity of the fluid in a pipe is determined. Further physical quantities are derived from the flow velocity and from additional physical quantities, if necessary.

3.1 Measurement principle

The flow velocity of the fluid is measured in the TransitTime mode using the ultrasonic-transit time difference correlation principle. When measuring with a high proportion of gas or solid particles, the transmitter can toggle into the NoiseTrek mode.

3.1.1 Terms

Flow profile

Distribution of flow velocities over the cross-sectional pipe area. For an optimal measurement, the flow profile has to be fully developed and axisymmetrical. The shape of the flow profile depends on whether the flow is laminar or turbulent and is influenced by the conditions at the inlet of the measuring point.

Reynolds number Re

Coefficient describing the turbulence behavior of a fluid in the pipe. The Reynolds number Re is calculated from the flow velocity, the kinematic viscosity of the fluid and the inner pipe diameter.

If the Reynolds number exceeds a critical value (usually approx. 2300, if the fluid flows in a pipe), a transition from a laminar flow to a turbulent flow takes place.

Laminar flow

A flow without any turbulence. There is no mixing between the parallel flowing layers of the fluid.

Turbulent flow

A flow with turbulences (swirling of the fluid). In technical applications, the flow in the pipe is mostly turbulent.

Transition range

The flow is partly laminar and partly turbulent.

Sound speed c

Speed of the propagating sound. The sound speed depends on the mechanical properties of the fluid or the pipe material. In pipe materials and other solid materials, a distinction is made between the longitudinal and transversal sound speed.

Flow velocity v

Average value of all flow velocities of the fluid over the cross-sectional pipe area.

Acoustic calibration factor k_a

$$k_a = \frac{c_\alpha}{\sin \alpha}$$

The acoustic calibration factor k_a is a transducer parameter which results from the sound speed c within the transducer and the angle of incidence. According to Snell's law of refraction, the angle of propagation in the adjoining fluid or pipe material is:

$$k_a = \frac{c_\alpha}{\sin \alpha} = \frac{c_\beta}{\sin \beta} = \frac{c_\gamma}{\sin \gamma}$$

Fluid mechanics calibration factor k_{Re}

With the fluid mechanics calibration factor k_{Re} , the measured value of the flow velocity in the area of the sound beam is converted into the value of the flow velocity across the whole cross-sectional pipe area. In case of a fully developed flow profile, the fluid mechanics calibration factor only depends on the Reynolds number and the roughness of the inner pipe wall. The fluid mechanics calibration factor is recalculated by the transmitter for each new measurement.

Volumetric flow rate \dot{V}

$$\dot{V} = v \cdot A$$

The volume of the fluid that passes through the pipe per unit time. The volumetric flow rate is calculated from the product of the flow velocity v and the cross-sectional pipe area A .

Mass flow rate \dot{m}

$$\dot{m} = \dot{V} \cdot \rho$$

The mass of the fluid that passes through the pipe per unit time. The mass flow rate is calculated from the product of the volumetric flow rate \dot{V} and the density ρ .

Thermal energy rate Φ

The thermal energy that is transported per unit time.

3.1.2 Measurement of the flow velocity in the TransitTime mode

The signals are emitted and received by two transducers alternatively in and against the flow direction. If the fluid is flowing, the signals propagating in the fluid are displaced with the flow.

Caused by this displacement, the sound path of the signal is reduced in flow direction and increased in the opposite direction.

This causes a change in the transit times. The transit time of the signal in flow direction is shorter than the transit time against the flow direction. The transit time difference is proportional to the average flow velocity.

The average flow velocity of the fluid is calculated as follows:

$$v = k_{Re} \cdot k_a \cdot \frac{\Delta t}{2 \cdot t_f}$$

where

- v – average flow velocity of the fluid
- k_{Re} – fluid mechanic calibration factor
- k_a – acoustic calibration factor
- Δt – transit time difference
- t_f – transit time in the fluid

Fig. 3.1: Sound path of the signal in the flow direction

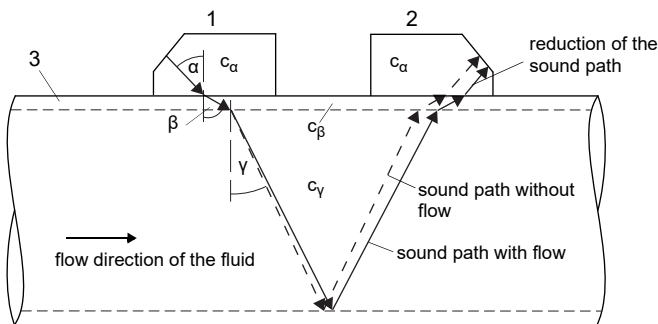

- c – sound speed
- 1 – transducer (emitter)
- 2 – transducer (receiver)
- 3 – pipe wall

Fig. 3.2: Sound path of the signal against the flow direction

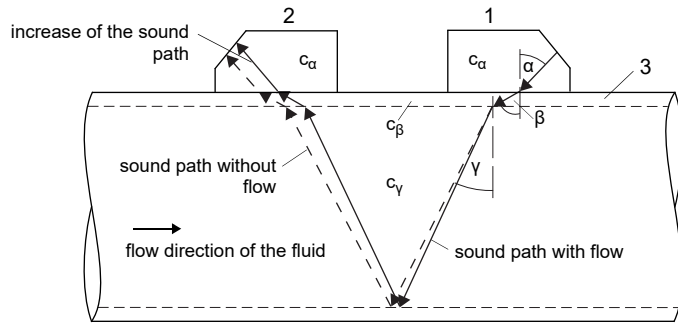

- c – sound speed
- 1 – transducer (emitter)
- 2 – transducer (receiver)
- 3 – pipe wall

Fig. 3.3: Transit time difference Δt

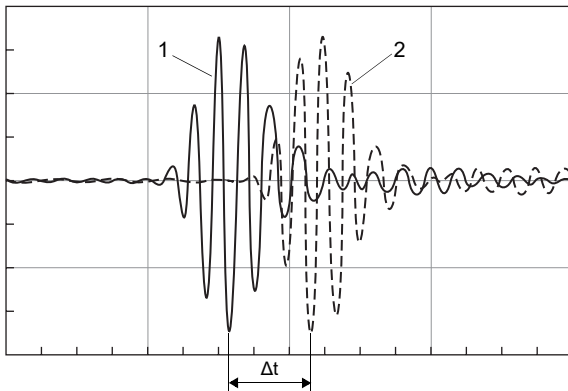

- 1 – signal in the flow direction
- 2 – signal against the flow direction

3.1.3 Measurement of the flow velocity in the NoiseTrek mode

If the proportion of gas bubbles and/or solid particles in the fluid is high, the damping of the ultrasonic signal can be so high that the complete propagation of the fluid and therefore a measurement in TransitTime mode is not possible. In this case the NoiseTrek mode has to be used.

The NoiseTrek mode uses the presence of gas bubbles and/or solid particles in the fluid.

Ultrasonic signals are sent by a transducer into the fluid at short intervals, reflected by gas bubbles and/or solid particles and received again by the same transducer.

The measurement arrangement used in the TransitTime mode does not need to be changed.

The transit time difference Δt of 2 consecutive ultrasonic signals is determined. It is proportional to the distance the gas bubble/solid particle is covering between 2 consecutive pulses and thus to the average flow velocity of the fluid.

Fig. 3.4: Measurement of the flow velocity in the NoiseTrek mode

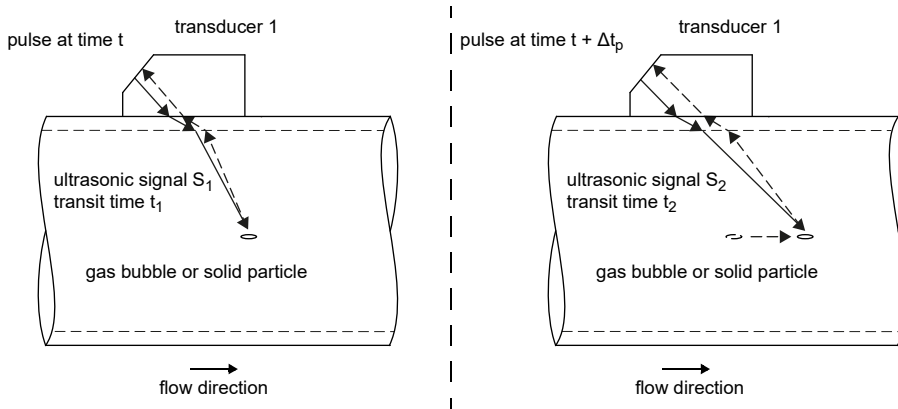

The average flow velocity of the fluid is calculated as follows:

$$v = k_{Re} \cdot k_a \cdot \frac{\Delta t}{2 \cdot \Delta t_p}$$

where

- v – average flow velocity of the fluid
- k_{Re} – fluid mechanic calibration factor
- k_a – acoustic calibration factor
- Δt_p – time difference between 2 consecutive pulses
- Δt – transit time difference of ultrasonic signals S_1 and S_2 ($\Delta t = t_2 - t_1$)

Depending on the attenuation of the ultrasonic signal, the measurement error in the NoiseTrek mode can be greater than in the TransitTime mode.

3.1.4 Measurement of the flow velocity in the HybridTrek mode

The HybridTrek mode combines the TransitTime and the NoiseTrek mode. During a measurement in the HybridTrek mode, the transmitter automatically toggles between the TransitTime and the NoiseTrek mode depending on the proportion of gas bubbles and solid particles in the fluid.

The measurement arrangement is identical to the one in the TransitTime mode.

3.1.5 Measurement of the flow velocity in the NoiseTrek parallel beam mode

Pipes with a small diameter or fluids which strongly attenuate the ultrasonic signal can cause a reduction of the transit time in the fluid with the result that the signal quality is no longer sufficient. In this case the NoiseTrek parallel beam mode has to be used.

The NoiseTrek parallel beam mode works the same way the NoiseTrek mode does, the only difference is that the sending and receiving process do not occur in the same transducer. This leads to a better signal quality. The transducers are mounted in parallel at a small distance from each other on the pipe.

A measurement in TransitTime mode is not possible when using this measurement arrangement.

Fig. 3.5: Measurement arrangement in the NoiseTrek parallel beam mode

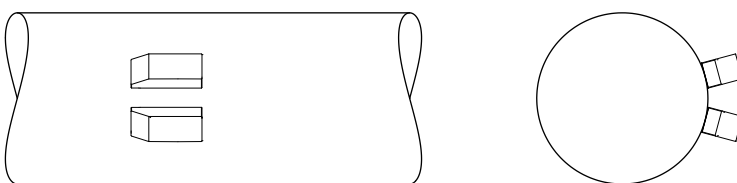

3.1.6 Synchronized channel averaging (FLUXUS *722)

Synchronized channel averaging reduces turbulence-related fluctuations of the measured value without the need of long-term averaging. When measuring in reflection arrangement, X arrangement or displaced X arrangement with synchronized channel averaging, the almost simultaneous measurement of all measuring beams results in optimized compensation of turbulent flow fluctuations.

For the synchronized channel averaging, all transducer pairs must be of the same type and installed at the same measuring point. The measurement arrangement has to be the same for all transducer pairs.

3.2 Measurement arrangements

3.2.1 Terms

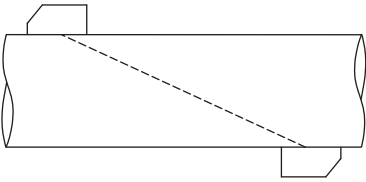
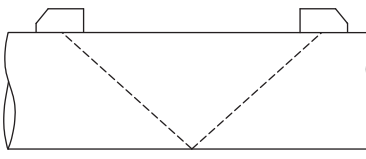
diagonal arrangement	reflection arrangement
The transducers are mounted on opposite sides of the pipe.	The transducers are mounted on the same side of the pipe.
	

Sound path

The distance covered by the ultrasonic signal after crossing the pipe once. The number of the sound paths is:

- odd if the measurement is carried out in diagonal arrangement
- even if the measurement is carried out in reflection arrangement

Beam

The path covered by the ultrasonic signal between the transducers, i.e., the transducer emitting the ultrasonic signal and the transducer receiving it. One beam consists of 1 or several sound paths.

Fig. 3.6: Diagonal arrangement with 2 beams and 3 sound paths

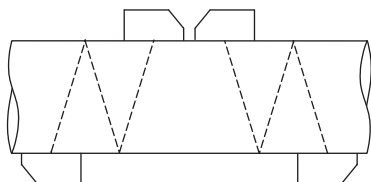
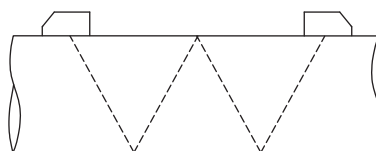
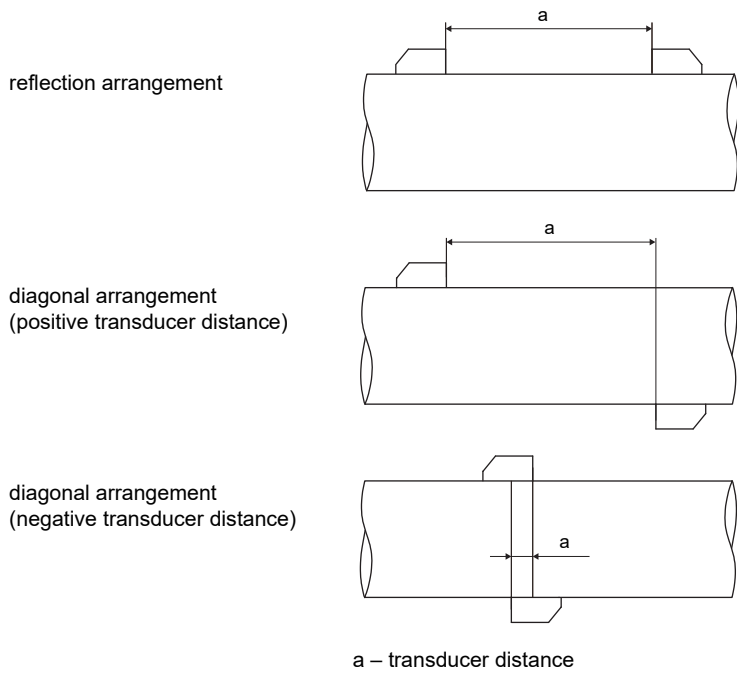

Fig. 3.7: Reflection arrangement with 1 beam and 4 sound paths



Transducer distance

The transducer distance is measured between the inner edges of the transducers.



Sound beam plane

Plane containing 1 or several sound paths or beams

Fig. 3.8: 2 beams in 1 plane

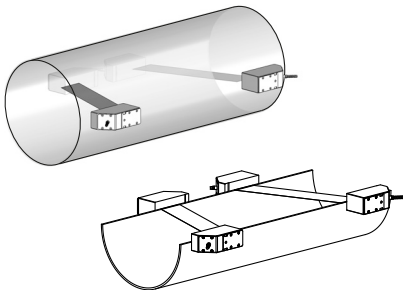
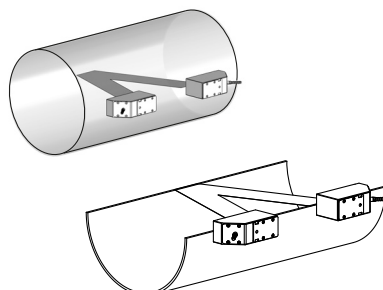
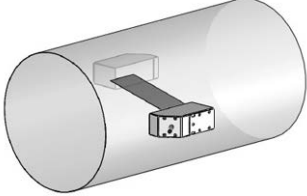
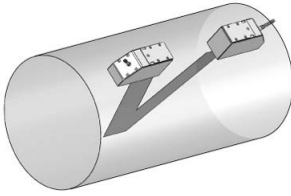
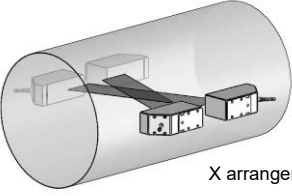
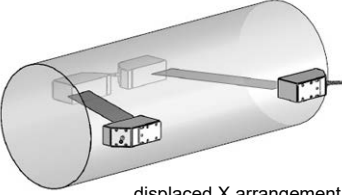
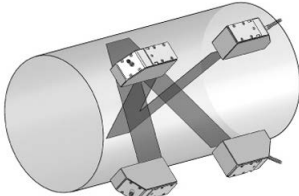

Fig. 3.9: 2 sound paths in 1 plane



3.2.2 Examples

diagonal arrangement with 1 beam	reflection arrangement with 1 beam
<p>1 transducer pair 1 sound path 1 beam 1 plane</p> 	<p>1 transducer pair 2 sound paths 1 beam 1 plane</p> 
diagonal arrangement with 2 beams	reflection arrangement with 2 beams and 2 planes
<p>2 transducer pairs 2 sound paths 2 beams 1 plane</p>  <p style="text-align: right;">X arrangement</p>  <p style="text-align: right;">displaced X arrangement</p>	<p>2 transducer pairs 4 sound paths 2 beams 2 planes</p> 

3.3 Acoustic penetration

The pipe has to be acoustically penetrable at the measuring point. The acoustic penetration is given when pipe and fluid do not attenuate the sound signal so strongly that it is completely absorbed before reaching the second transducer.

The attenuation caused by the pipe and the fluid depends on:

- kinematic viscosity of the fluid
- proportion of gas bubbles and solid particles in the fluid
- deposits on the inner pipe wall
- pipe material

The following requirements have to be met at the measuring point:

- pipe always completely filled
- no deposits of solid particles in the pipe
- no formation of gas bubbles

Notice!

Even bubble-free fluids can form gas bubbles when the fluid expands, e.g., before pumps and after great cross-section extensions.

Observe the following notes on the selection of the measuring point:

Horizontal pipe

Select a measuring point where the transducers can be mounted laterally on the pipe, allowing the sound waves to propagate horizontally in the pipe. Thus, solid particles on the bottom of the pipe or gas bubbles in the upper part are prevented from influencing the propagation of the signal.

Fig. 3.10: Recommended transducer mounting position (laterally)

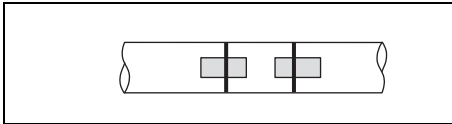
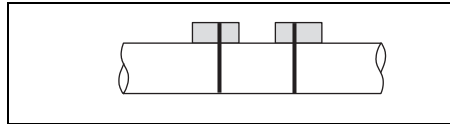

Fig. 3.11: Disadvantageous transducer mounting position (on top)



Vertical pipe

Select the measuring point at a pipe section where the fluid flows upward. The pipe has to be completely filled.

Fig. 3.12: Recommended transducer mounting position

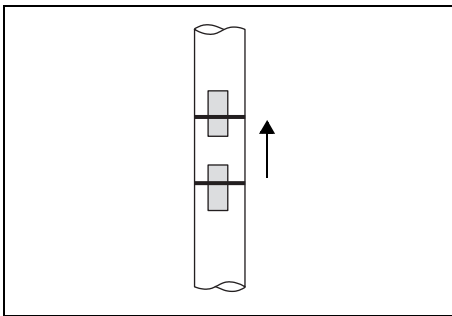
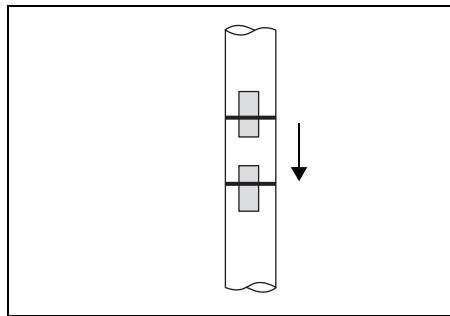

Fig. 3.13: Disadvantageous transducer mounting position



Free inlet or outlet pipe section

Select the measuring point at a pipe section where the pipe cannot run empty.

Fig. 3.14: Recommended transducer mounting position

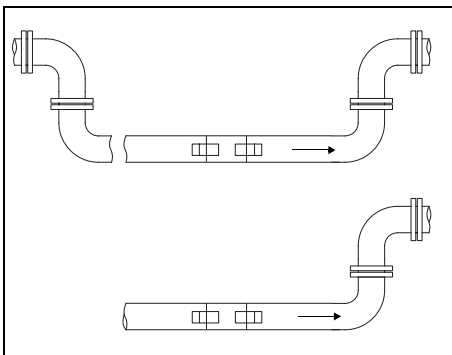
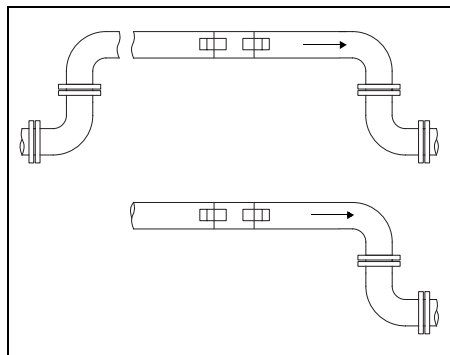

Fig. 3.15: Disadvantageous transducer mounting position



3.4 Undisturbed flow profile

Some flow elements (e.g., elbows, valves, pumps, reducers) distort the flow profile in their vicinity. The axisymmetrical flow profile in the pipe needed for correct measurement is no longer given. A careful selection of the measuring point helps to reduce the impact of disturbances.



It is most important that the measuring point is chosen at a sufficient distance from any disturbances. Only then it can be assumed that the flow profile in the pipe is fully developed. The use of the disturbance correction (see section 13.2.1) allows a measurement even at smaller distances of min. 2 d.

The recommended straight inlet and outlet pipe lengths for different types of flow disturbances are shown in the following table.

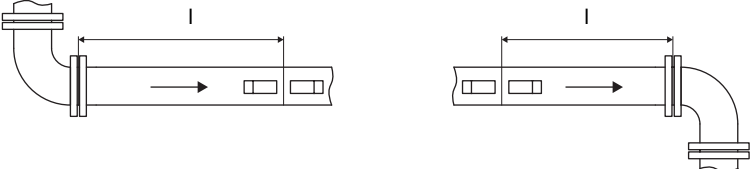
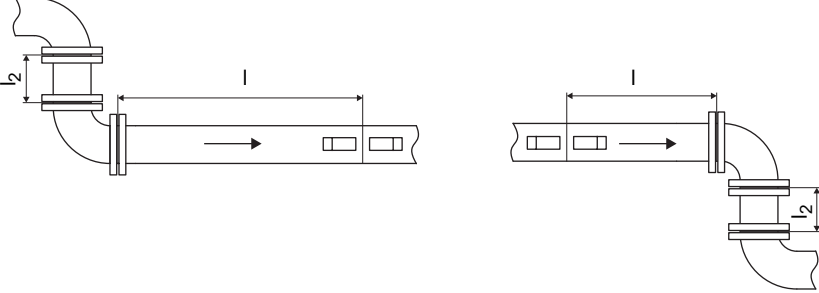
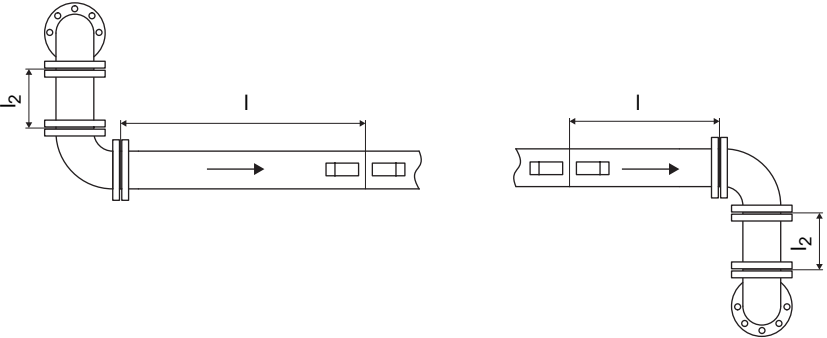
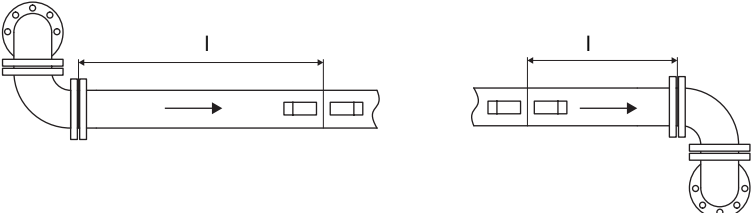
Tab. 3.1: Recommended distance from disturbances
 d – inner pipe diameter at the measuring point
 l – recommended distance between disturbance and transducer position

<p>disturbance: 90° elbow</p> <p>inlet: $l \geq 10 D$ ($l \geq 2 d$ with disturbance correction)</p> <p>outlet: $l \geq 3 d$</p> 
<p>disturbance: 90° double elbow (with elbow distance $l_2 \geq 3 d$)</p> <p>inlet: $l \geq 10 D$ ($l \geq 2 d$ with disturbance correction)</p> <p>outlet: $l \geq 3 d$</p> 
<p>disturbance: double elbow out of plane (with elbow distance $l_2 \geq 3 d$)</p> <p>inlet: $l \geq 10 D$ ($l \geq 2 d$ with disturbance correction)</p> <p>outlet: $l \geq 3 d$</p> 
<p>disturbance: double elbow out of plane (directly coupled)</p> <p>inlet: $l \geq 40 D$ ($l \geq 2 d$ with disturbance correction)</p> <p>outlet: $l \geq 3 d$</p> 

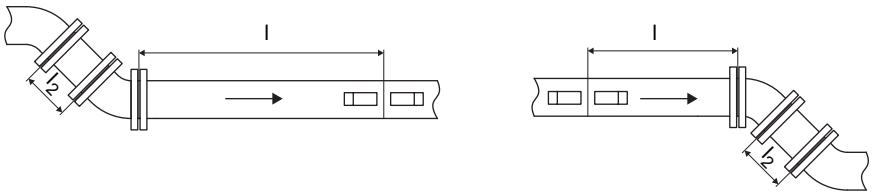
Tab. 3.1: Recommended distance from disturbances
 d – inner pipe diameter at the measuring point
 l – recommended distance between disturbance and transducer position

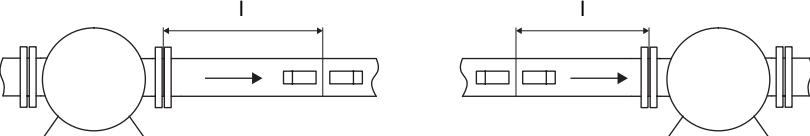
<p>disturbance: 45° elbow</p> <p>inlet: $l \geq 15 D$ ($l \geq 2 d$ with disturbance correction)</p> <p>outlet: $l \geq 3 d$</p> 
<p>disturbance: 45° double elbow (with elbow distance $l_2 \geq 3 d$)</p> <p>inlet: $l \geq 15 D$ ($l \geq 2 d$ with disturbance correction)</p> <p>outlet: $l \geq 3 d$</p> 
<p>disturbance: valve</p> <p>inlet: $l \geq 40 d$</p> <p>outlet: $l \geq 3 d$</p> 
<p>disturbance: reducer</p> <p>inlet: $l \geq 10 D$ ($l \geq 2 d$ with disturbance correction)</p> <p>outlet: $l \geq 3 d$</p> 
<p>disturbance: pump</p> <p>inlet: $l \geq 20 d$</p> <p>outlet: $l \geq 3 d$</p> 

4 Product description

4.1 Measuring system

The measurement system consists of the transmitter, the ultrasonic transducers and the pipe on which the measurement is carried out.

Fig. 4.1: Example of a measurement arrangement

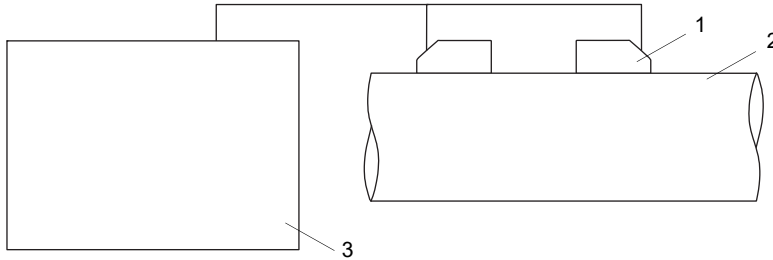

- 1 – transducer
- 2 – pipe
- 3 – transmitter

The transducers are mounted on the outside of the pipe. They send and receive ultrasonic signals through the fluid.

The transmitter controls the measuring cycle, eliminates noise signals and analyzes useful signals. The measured values can be displayed, used for calculations and transmitted.

4.2 Handling concept

The transmitter is operated via the keyboard. By pressing **4** or **6** the menus are displayed consecutively.

Fig. 4.2: Command panel of the transmitter

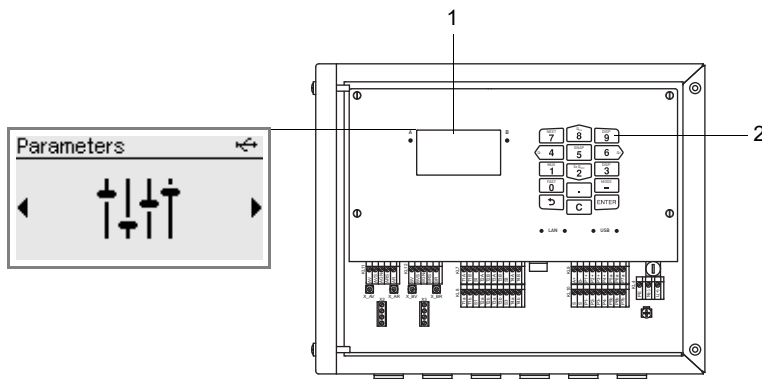

- 1 – LCD display (backlit)
- 2 – keyboard

Tab. 4.1: Description of the menus

menu	description
Parameters	input of sensor, pipe and fluid parameters
Installation	input of measuring point specific parameters
Start measurement	measurement start ⁽¹⁾
Show measurement	measured value display ⁽²⁾
Stop measurement	measurement stop ⁽²⁾
Inputs	configuration and assignment of inputs
Outputs	output configuration
Functions	configuration of event triggers and remote functions
Storage	configuration of the data logger and snaps
Calibration	definition of correction values to compensate unfavorable measuring conditions
Communication	configuration of communication interfaces (e.g. fieldbuses (option))
Miscellaneous	settings of system and measurement and changes in dialogs and menus

⁽¹⁾ will only be displayed if no measurement is running

⁽²⁾ will only be displayed if a measurement is running

When starting up the transmitter for the first time, settings relating to the language, time, date and system of units have to be made. Afterwards the menu `Parameters` will be displayed.

At later start-ups the measured values will be displayed in case the measurement had not been stopped before the transmitter was disconnected from the power supply. If the measurement is stopped, the menu `Parameters` will be displayed.

After starting the measurement, the parameter settings or the configuration of the transmitter outputs can be displayed at any time without interrupting the measurement. A change of the parameter settings is not possible during the measurement. The measurement has to be stopped in order to change the parameter settings or configuration of the transmitter outputs.

4.3 Display

Structure

Fig. 4.3: Example: menu Parameters

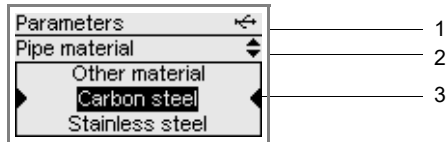

- 1 – menu
- 2 – menu item currently edited
- 3 – area for scroll lists, selection fields or input fields

Tab. 4.2: Navigation

horizontal scroll list	vertical scroll list	selection fields	input fields
<ul style="list-style-type: none"> • scroll horizontally with or CLR 	<ul style="list-style-type: none"> • scroll vertically with or 	<ul style="list-style-type: none"> • scroll horizontally with or CLR • activate/deactivate with 	<ul style="list-style-type: none"> • input numbers or text with or • delete with CLR

Status indications

Several symbols are used for the status indications.

Fig. 4.4: Status indications (line 1)

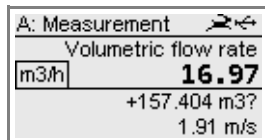



- running measurement
- error message
- activated FastFood mode
- data logger full
- connection via USB cable
- key lock activated

4.4 Keyboard





The keyboard has 15 keys, including 3 function keys: ENTER,  and C.

Some keys have multiple functions. They can be used to enter data, to navigate through scroll lists as well as to execute special functions (e.g., reset of totalizers).





Tab. 4.3: General functions

ENTER	confirmation of selection or input
 + C + ENTER	Reset: press these 3 keys simultaneously to correct a malfunction. The reset has the same effect as a restart of the transmitter. Stored data are not affected.
 + C	INIT: when initializing the transmitter, all settings are reset to the factory settings.









Tab. 4.4: Navigation

	during the parameter input: short press: return to the previous menu item long press (several seconds): return to the beginning of the menu during the measurement: display of scroll list: Stop measurement, Show parameters, Show measurement
 	scroll to the left/right through a scroll list
 	scroll upwards/downwards through a scroll list
ENTER	confirmation of a menu item

Tab. 4.5: Input of numbers

 ... 	input of the number pictured on the key
	sign for the input of negative values
	decimal marker
C	deletion of values After the value has been deleted, the previous value will be displayed.
ENTER	confirmation of the input

Tab. 4.6: Input of text

 	positioning of the cursor
	"A" is displayed and capitalization is activated
	"Z" is displayed and capitalization is activated
	tooggling between upper and lower case
 	selection of the previous/next character
	deletion of a character and insertion of a blank
ENTER	confirmation of the input

5 Transport and storage

Caution!

**When packaging, the transmitter can fall down.**

There is a danger of crushing body parts or damaging the measuring equipment.

- Secure the transmitter against falling during packaging.
- Wear the required personal protective equipment.
- Observe the applicable rules.

Caution!

**When lifting, the center of gravity of the transmitter can be displaced within the cardboard box. The transmitter can fall down.**

There is a danger of crushing body parts or damaging the measuring equipment.

- Secure the transmitter against falling during transport.
- Wear the required personal protective equipment.
- Observe the applicable rules.

5.1 Transport

The measuring equipment must be packaged properly for transport. For weight indications, see technical specification.

- Use, if possible, the original packaging by FLEXIM or an equivalent cardboard box.
- Position the transmitter, transducers and accessories in the middle of the cardboard box.
- Fill any voids with appropriate packaging material (e.g., paper, foam, bubble wrap).
- Protect the cardboard box against humidity.

5.2 Storage

- Store the measuring equipment within the original package.
- Do not store the measuring equipment outdoors.
- Seal all openings with blind plugs.
- Protect the measuring equipment against sunlight.
- Storage the measuring equipment in a dry place without dust and within the valid temperature range, see technical specification.

6 Mounting

Danger!



Risk of explosion when using the measuring equipment in explosive atmospheres

This may result in personal or material damage or dangerous situations.

→ Observe the "Safety instructions for the use in explosive atmospheres".

Warning!



Installation, connection and start-up by unauthorized and unqualified personnel

This may result in personal or material damage or dangerous situations.

→ Any work on the transmitter has to be carried out by authorized and qualified personnel.

Danger!



Working in mines or cramped confines

Risk of intoxication and/or asphyxiation because of emerging gases, risk of injuries because of cramped conditions.

→ Wear the required personal protective equipment.

→ Observe the applicable rules.

Warning!



Touching live parts

Electric shock or arc faults can lead to severe injuries. The measuring equipment can be damaged.

→ Prior to any work on the transmitter (e.g., installation, dismantling, connection, start-up), the transmitter has to be disconnected from the power supply. It is not sufficient to remove the internal fuse of the instrument.

Caution!



Safety and accident prevention regulations for electrical systems and equipment

Failure to observe these regulations may lead to severe injuries.

→ Observe the safety and accident prevention regulations for electrical systems and equipment.

Caution!



Touching hot or cold surfaces

This may result in injuries (e.g., thermal damages).

→ Observe the ambient conditions at the measuring point during installation.

→ Wear the required personal protective equipment.

→ Observe the applicable rules.

Important!

Remove all protective foils before using the measuring equipment in explosive atmospheres (see document SIFLUXUS).

6.1 Transmitter

6.1.1 Opening and closing the housing

6.1.1.1 Opening

Caution!



Possible danger by opening the equipment at improper ambient conditions

Open the transmitter in safe ambient conditions only (e.g., air humidity < 90 %, no conductive pollution, no explosive atmosphere). Otherwise, additional protective measures have to be taken.

Important!

Do not use objects which may damage the housing gasket to open the housing cover.

- Loosen the screws of the transmitter housing.
- Open the housing cover of the transmitter.

6.1.1.2 Closing

Transmitter with stainless steel housing

- Close the housing cover.
- Tighten the screws of the transmitter housing with a max. torque of 1 Nm.

Fig. 6.1: Transmitter

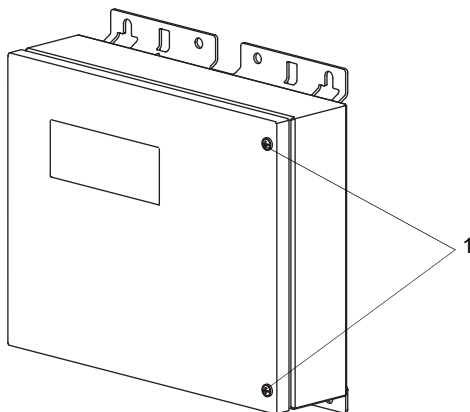

1 – screws

Transmitter with aluminum housing

- Close the housing cover pressing it slightly upwards on the side of the screws.
- Hand-tight all screws of the transmitter housing.

Fig. 6.2: Transmitter

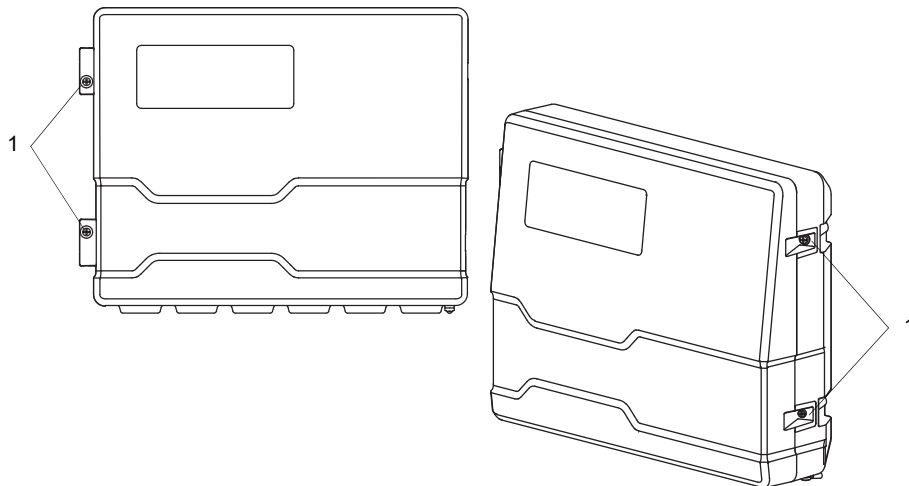

1 – screws

6.1.2 Installation of the transmitter

Notice!

Install the equipment in a shady place, the cable glands facing downward. Observe the temperature and weight indications according to the technical specification when choosing the fixation elements and the place of installation.

6.1.2.1 Wall mounting

Transmitter with stainless steel housing

- Fix the transmitter to the wall using 4 screws.

Fig. 6.3: Transmitter (dimensions in mm)

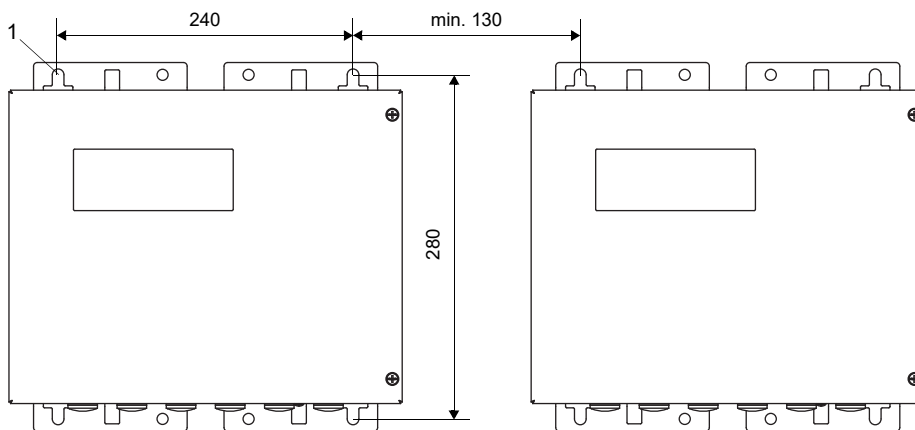

1 – fixing hole for wall mounting \varnothing 9.5

Transmitter with aluminum housing

- Fix the wall mount (2) with 3 countersunk-head screws (3) firmly to the wall.
- Attach the transmitter (1) to the lower hooks (7) of the wall mount.
- Fix the transmitter to the wall mount by locking the stop bolt (4) into the destined hole and by firmly tightening the screw (5).

Fig. 6.4: Transmitter (dimensions in mm)

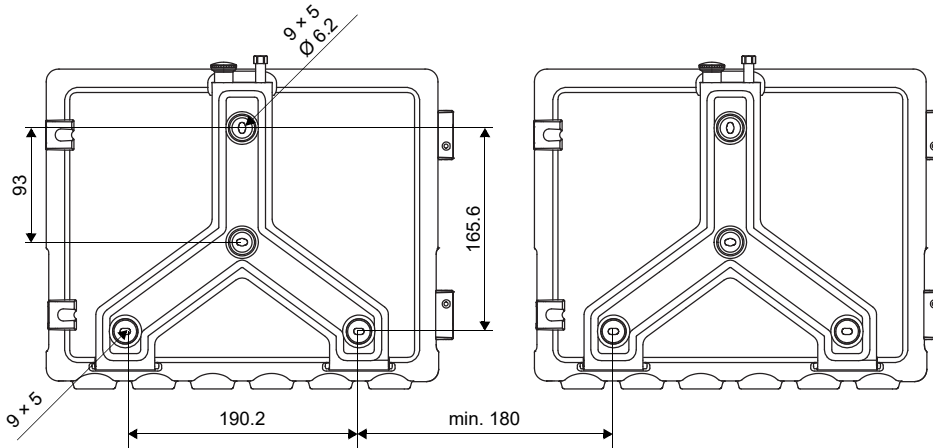
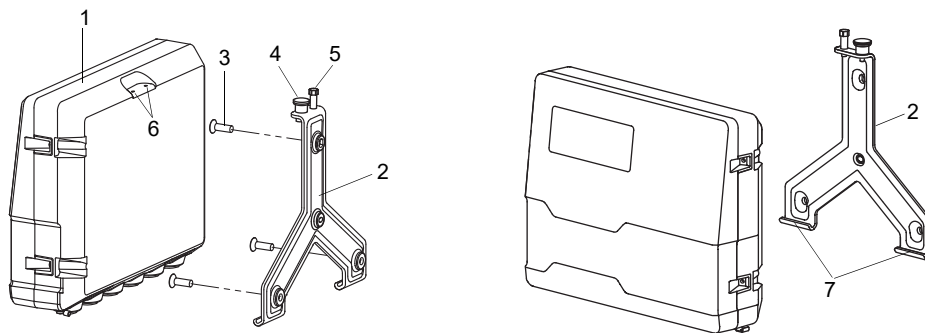

Fig. 6.5: Installation view



- 1 – transmitter
- 2 – wall mount
- 3 – countersunk-head screw
- 4 – stop bolt
- 5 – screw
- 6 – hole
- 7 – hook

6.1.2.2 Pipe mounting

Notice!

The pipe has to be sufficiently stable to withstand the pressure exerted by the transmitter and the shackles.

Transmitter with stainless steel housing

Installation on a 2" pipe

- Position the transmitter and the shackle (1) on the pipe.
- Fix the transmitter to the pipe by tightening the nuts (2) of the shackles.

Mounting on a pipe > 2"

The pipe mounting kit is fixed to the pipe by using tension straps.

Caution!



The edge of the tension strap is very sharp.

Risk of injury!

- Debur sharp edges.
- Wear the required personal protective equipment.
- Observe the applicable rules.

- Fix the transmitter to the pipe by using tension straps instead of shackles.

Fig. 6.6: Installation view

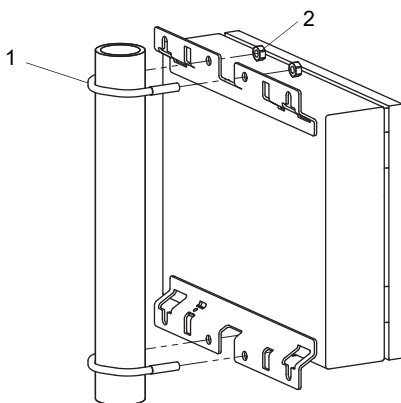

- 1 – shackle
- 2 – nut

Transmitter with aluminum housing**Notice!**

For the mounting on pipes the pipe mounting kit, consisting of 2 band clamps, 2 countersunk-head screws and 2 washers, is needed. The distance of the band clamps has to be identical to the distance of the holes on the wall mount.

- Fix the band clamps (6) with 2 countersunk-head screws (4) firmly to the wall mount (1). Take care to place the washers (7) between the wall mount and the band clamp.
- Fix the wall mount with the band clamps to the pipe.
- Attach the transmitter to the lower hooks (8) of the wall mount.
- Fix the transmitter to the wall mount by locking the stop bolt (2) into the destined hole and by firmly tightening the screw (3).

Fig. 6.7: Installation view

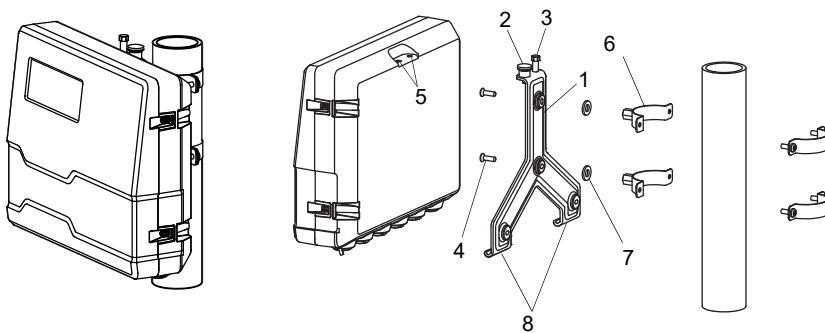

- 1 – wall mount
- 2 – stop bolt
- 3 – screw
- 4 – countersunk-head screw
- 5 – hole
- 6 – band clamp
- 7 – washer
- 8 – hook

6.2 Transducers

Caution!



Warning of severe injuries from hot or cold components

Touching hot or cold components can lead to severe injuries (e.g., thermal damage).

- Any mounting, installation or connection work has to be concluded.
- Any work on the measuring point during the measurement is prohibited.
- Observe the ambient conditions at the measuring point during installation.
- Wear the required personal protective equipment.
- Observe the applicable rules.

6.2.1 Preparation

6.2.1.1 Measuring point selection

The correct selection of the measuring point is crucial for achieving reliable measurement results and a high measurement accuracy.

A measurement on a pipe is possible if:

- the ultrasound propagates with a sufficiently high amplitude
- the flow profile is fully developed

The correct selection of the measuring point and the correct transducer positioning guarantee that the sound signal will be received under optimum conditions and evaluated correctly.

Because of the variety of applications and the different factors that influence the measurement, there is no standard solution for the transducer positioning.

The measurement is influenced by the following factors:

- diameter, material, lining, wall thickness and shape of the pipe
- fluid
- gas bubbles in the fluid
- Avoid measuring points in the vicinity of distorted or defective areas of the pipe or in the vicinity of welds.
- Avoid measuring points with deposit formation in the pipe.
- Make sure the pipe surface at the selected measuring point is even.
- Select the location of the transmitter within the transducer cable range.
- The temperature at the measuring point has to be within the specific ambient temperature range of the transmitter and the transducers (see technical specification).

If the measuring point is within an explosive atmosphere, possibly present danger zones and gases have to be determined. The transducers and the transmitter have to be appropriate for these conditions.

6.2.1.2 Pipe preparation

Caution!



Contact with grinding dust

This may result in injuries (e.g., breathing difficulties, skin reactions, eye irritations).

- Wear the required personal protective equipment.
- Observe the applicable rules.

Important!

The pipe has to be sufficiently stable to withstand the pressure exerted by the transducers and the fasteners.

Notice!

Observe the selection criteria of pipe and measuring point.

Rust, paint or deposits on the pipe absorb the sound signal. A good acoustic contact between the pipe and the transducers is obtained as follows:

- Clean the pipe at the selected measuring point.
 - If present, the paint layer has to be smoothed by grinding. The paint does not need to be removed completely.
 - Remove any rust or loose paint.

6.2.1.3 Selection of the measurement arrangement

Diagonal arrangement with 1 beam

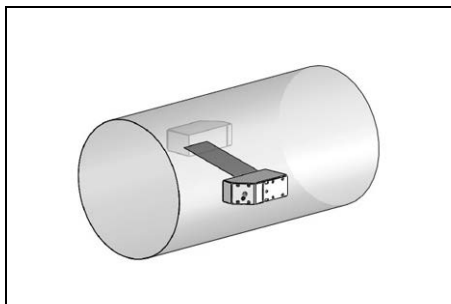

- wider flow velocity and sound speed range compared to the reflection arrangement
- use in the presence of deposits on the inner pipe wall or with strongly attenuating gases or liquids (only 1 sound path)

Reflection arrangement with 1 beam

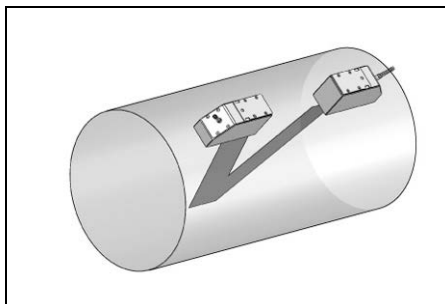

- smaller flow velocity and sound speed range compared to the diagonal arrangement
- cross-flow effects are compensated because the beam crosses the pipe in 2 directions
- higher accuracy of measurement because the accuracy increases with the number of sound paths

Diagonal arrangement with 2 beams

Reflection arrangement with 2 beams and 2 planes

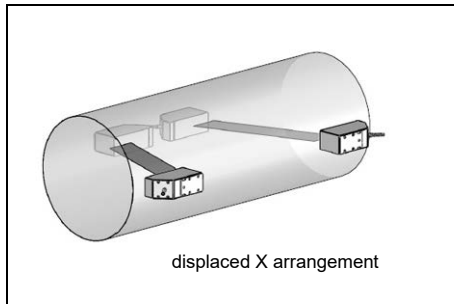
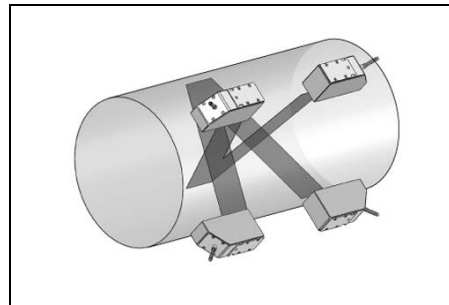
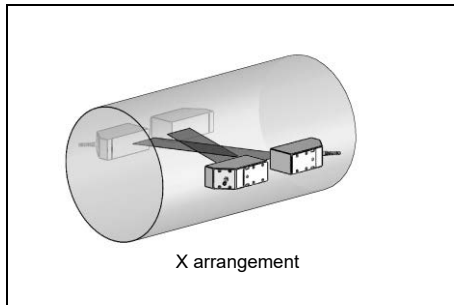

- same characteristics as reflection arrangement with 1 beam
- additional characteristic: influences of the flow profile are compensated because the measurement takes place in 2 planes

- same characteristics as diagonal arrangement with 1 beam
- additional characteristic: cross-flow effects are compensated because the measurement is conducted with 2 beams

If the measuring point is situated near an elbow, the following measurement arrangements are recommended for the selection of the sound beam plane.

Vertical pipe

Horizontal pipe

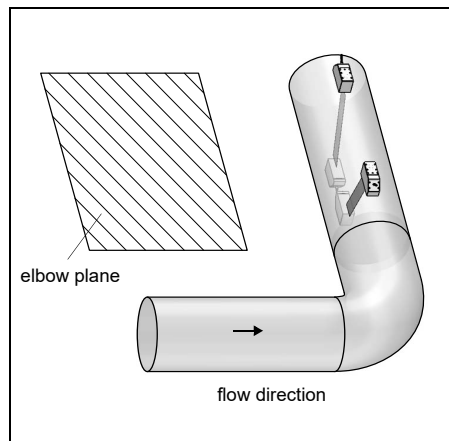
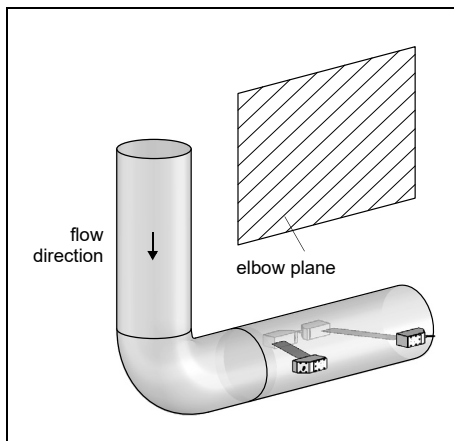

- The sound beam plane is selected at an angle of 90° to the elbow plane. The elbow is upstream of the measuring point.

- The sound beam plane is selected at an angle of $90^\circ \pm 45^\circ$ to the elbow plane. The elbow is upstream of the measuring point.

Bidirectional measurement

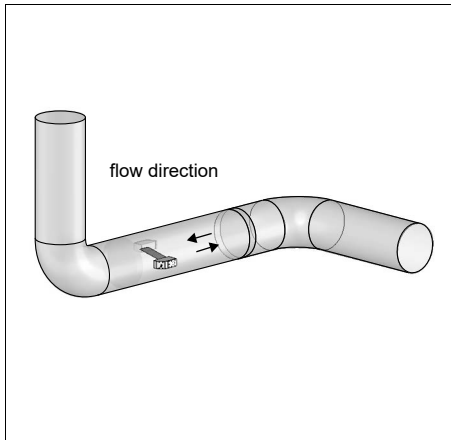

- The sound beam plane is selected according to the nearest elbow (horizontal or vertical, depending on the pipe orientation, see above).

Measurement in reflection arrangement with 2 beams and 2 planes

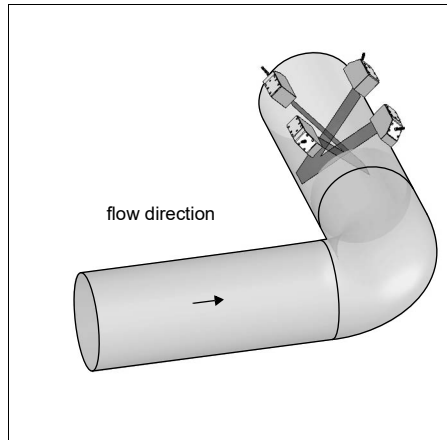

- The 2 sound beam planes are selected at an angle of 45° to the elbow plane. The elbow is upstream of the measuring point.
- On horizontal pipes, the transducers are mounted on the upper half of the pipe.

6.2.2 Installation of the transducers

6.2.2.1 Orientation of the transducers and determination of the transducer distance

Observe the orientation of the transducers. If the transducers have been mounted properly, the engravings on them form an arrow. The transducer cables show in opposite directions.

The transducer distance is measured between the inner edges of the transducers.

Fig. 6.8: Orientation and distance of the transducers

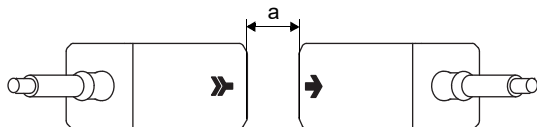

a – transducer distance

- Select the installation instructions of the supplied transducer mounting fixture.

6.2.2.2 Transducer arrangement

The transducers can be arranged in the mounting rails in different ways:

Fig. 6.9: Transducer arrangement in mounting rails

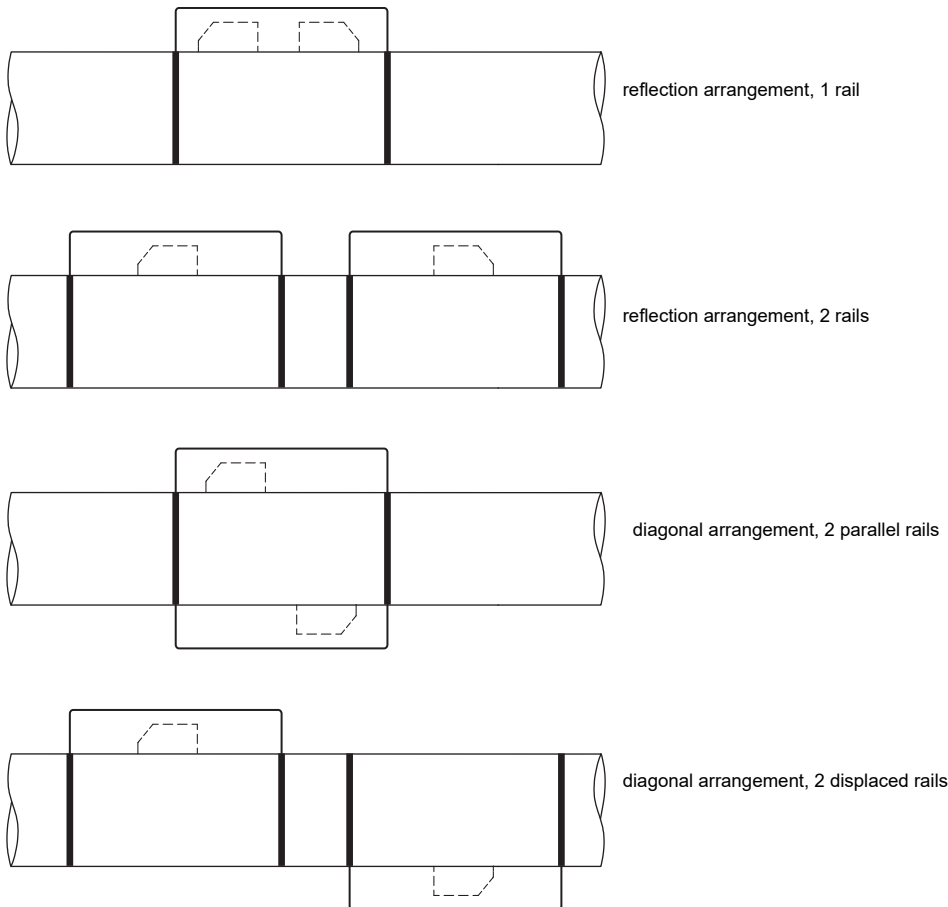

6.2.2.3 Mounting the transducers of type ****LI**

If the nameplate of the transducers ****LI** is removed from the transducer cable during installation, it has afterwards to be remounted and fixed to the transducer cable using the provided cable tie. The heat shrink tubing must not be reused.

Fig. 6.10: Nameplate on the transducer cable

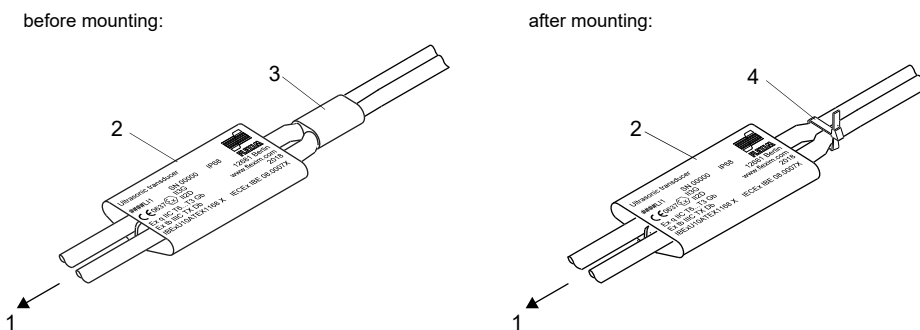

- 1 – transducers
- 2 – nameplate
- 3 – heat shrink tubing
- 4 – cable tie

6.2.2.4 Mounting with Variofix L (PermaRail)

Scope of delivery (example)

Variofix L

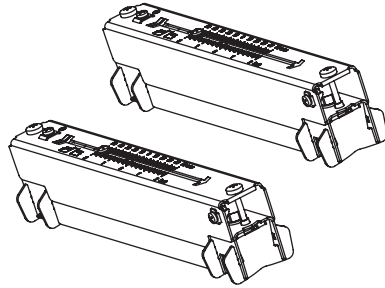

transducer pair

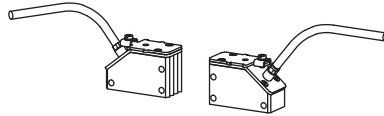

quick release clasp with tension strap

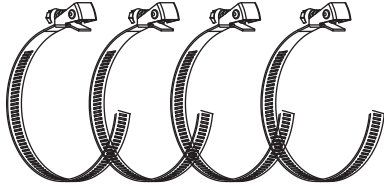

or

band clamp clasp with tension strap

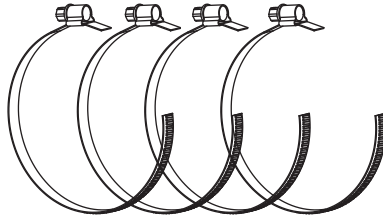

or

ratchet clasp and tension strap coil

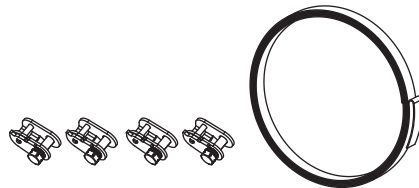

Mounting

When measuring in diagonal arrangement, the transducer mounting fixtures are mounted on opposite sides of the pipe. When measuring in reflection arrangement, the transducer mounting fixtures are mounted on the same side of the pipe. When measuring in diagonal arrangement with 2 beams in displaced X arrangement, 4 transducer mounting fixtures have to be mounted. When measuring in reflection arrangement with a small transducer distance, only 1 transducer mounting fixture has to be mounted.

Tab. 6.1: Approximate values for the mounting of both transducers in one Variofix L

transducer frequency (3rd character of the technical type)	rail length [mm]	transducer distance [mm]
F	368	< 94
G, H, K (****LI*)	368	< 94
G, H, K (except ****LI*)	348	< 89
M, P (Lamb wave transducers)	234	< 84
M, P (shear wave transducers)		< 100
Q	176	< 69

In the following, the mounting of 2 transducer mounting fixtures in reflection arrangement is described (1 transducer mounting fixture for each transducer).

Fig. 6.11: Transducer mounting fixture Variofix L (diagonal arrangement)

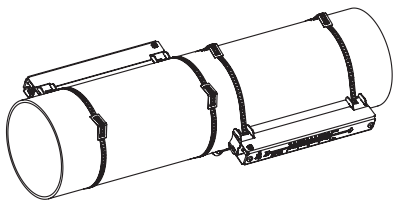
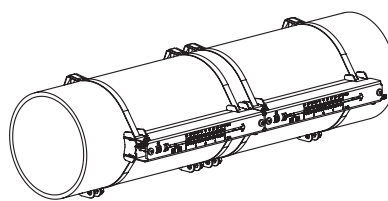

Fig. 6.12: Transducer mounting fixture Variofix L (reflection arrangement)



Overview of mounting steps

- **step 1**
disassembly of the transducer mounting fixture Variofix L
- **step 2**
fixation of the clasps to the tension straps
- **step 3**
fixation of the tension strap to the pipe
- **step 4**
fixation of the rail to the pipe
- **step 5**
installation of the transducers in the mounting fixture Variofix L

Step 1: Disassembly of the transducer mounting fixture Variofix L

- Disassemble the transducer mounting fixture Variofix L.

Fig. 6.13: Disassembly of the transducer mounting fixture Variofix L

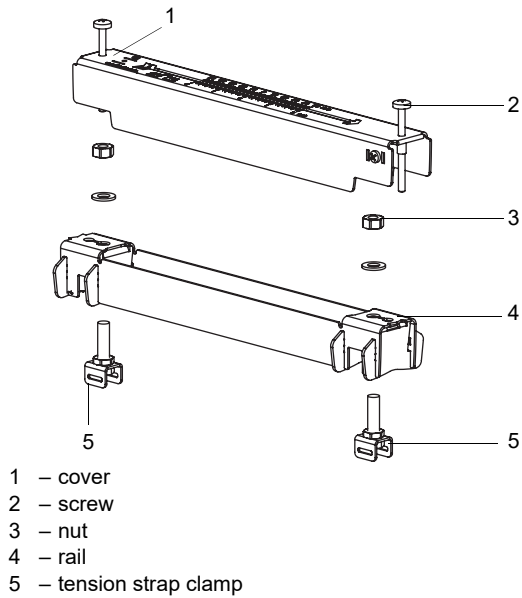
**Step 2: Fixation of the clasps to the tension straps**

- Select the installation instruction of the supplied clasp:

Band clamp clasp

The clasp is fixed to the tension strap (see Fig. 6.14).

Quick release clasp

The clasp is fixed to the tension strap (see Fig. 6.15).

- Cut the tension strap to length (pipe circumference + at least 120 mm).

Fig. 6.14: Band clamp clasp with tension strap

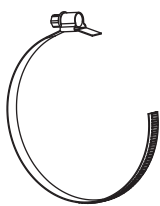
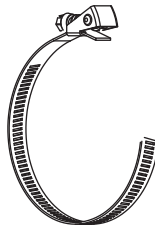

Fig. 6.15: Quick release clasp with tension strap



Ratchet clasp

- Cut the tension strap to length (pipe circumference + at least 120 mm).

Caution!



The edge of the tension strap is very sharp.

risk of injury

- Debur sharp edges.
- Wear the required personal protective equipment.
- Observe the applicable rules.

- Insert approx. 100 mm of the tension strap into part (1) and (2) of the ratchet clasp (see Fig. 6.16 a).
- Bend the tension strap.
- Insert the tension strap into part (1) of the ratchet clasp (see Fig. 6.16 b).
- Tighten the tension strap.
- Repeat the steps for the second tension strap.

Fig. 6.16: Ratchet clasp with tension strap

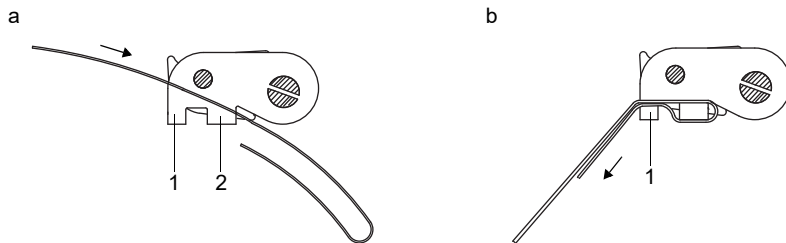

Step 3: Fixation of the tension strap to the pipe

One tension strap is fixed to the pipe. The second tension strap will be mounted later.

Fig. 6.17: Tension strap with clamp and metal spring on the pipe

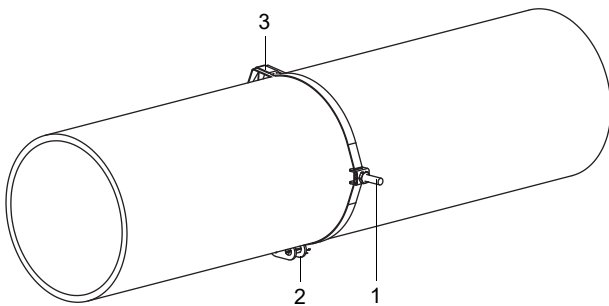

- 1 – tension strap clamp
- 2 – clasp
- 3 – metal spring

Select the installation instruction of the supplied clasp:

Band clamp clasp

- Insert the tension strap into its clamp (see Fig. 6.18).
- Position the clasp and the tension strap clamp on the pipe (see Fig. 6.17). On a horizontal pipe, mount the tension strap clamp laterally to the pipe, if possible.
- Place the tension strap around the pipe and insert it into the clasp (see Fig. 6.20).
- Tighten the tension strap.
- Tighten the clasp screw.

Quick release clasp

- Insert the tension strap into its clamp and the metal spring (see Fig. 6.18 and Fig. 6.19).
- Position the clasp, the tension strap clamp and the metal spring on the pipe (see Fig. 6.17):
 - On a horizontal pipe, mount the tension strap clamp laterally to the pipe, if possible.
 - Mount the metal spring opposite the tension strap clamp.

Fig. 6.18: Tension strap with clamp

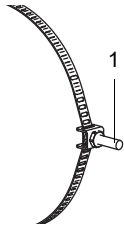

1 – tension strap clamp

Fig. 6.19: Tension strap with quick release clasp and metal spring

1 – clasp screw
2 – metal spring

Fig. 6.20: Tension strap with band clamp clasp



1 – clasp screw

- Place the tension strap around the pipe and insert it into the clasp (see Fig. 6.19).
- Tighten the tension strap.
- Tighten the clasp screw.

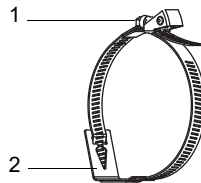
Ratchet clasp

- Insert the tension strap into its clamp and the metal spring (see Fig. 6.21). The metal spring does not have to be mounted on:
 - steel pipes
 - pipes with an outer diameter < 80 mm
 - pipes that are not subjected to significant temperature fluctuations
- Position the ratchet clasp, tension strap clamp and metal spring (if necessary) on the pipe (see Fig. 6.17):
 - On a horizontal pipe, mount the tension strap clamp laterally to the pipe, if possible.
 - Mount the metal spring (if necessary) opposite the tension strap clamp.
- Place the tension strap around the pipe and pass it through the slot of the clasp screw (see Fig. 6.22).
- Tighten the tension strap.
- Cut off the protruding tension strap (see Fig. 6.22).

Caution!**The edge of the tension strap is very sharp.**

risk of injury

- Debur sharp edges.
- Wear the required personal protective equipment.
- Observe the applicable rules.

- Tighten the clasp screw.

Notice!

In order to release the screw and the tension strap, press the lever down (see Fig. 6.22).

Fig. 6.21: Tension strap with metal spring and clamp



- 1 – metal spring
- 2 – tension strap clamp

Fig. 6.22: Ratchet clasp with tension strap

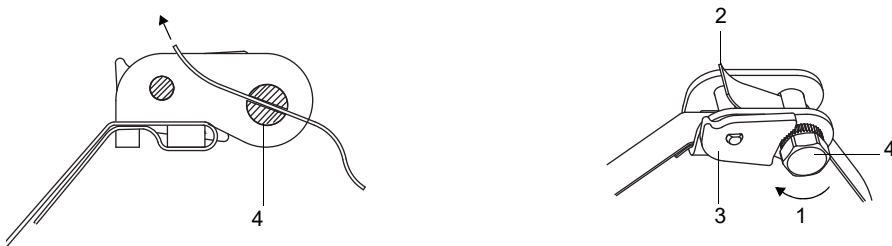

- 1 – sense of rotation
- 2 – edge
- 3 – lever
- 4 – clasp screw with slot

Step 4: Fixation of the rail to the pipe

- Place the tension strap clamp (2) in the rail (see Fig. 6.23). Observe the orientation of the tension strap clamp.
- Slightly tighten the nut of the tension strap clamp (2).
- Screw the rail to tension strap clamp (1) (see Fig. 6.24).
- Tighten the nut of tension strap clamp (1), but not too firmly in order not to damage the tension strap.

Fig. 6.23: Rail with tension strap clamp

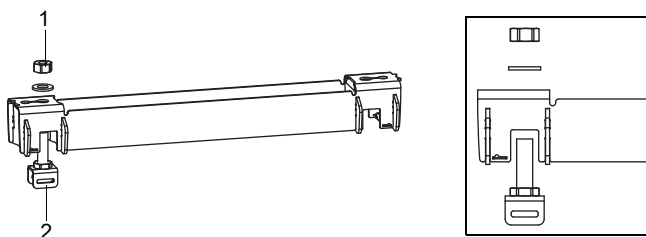

- 1 – nut
- 2 – tension strap clamp

Fig. 6.24: Rail, fixed on one side to the pipe

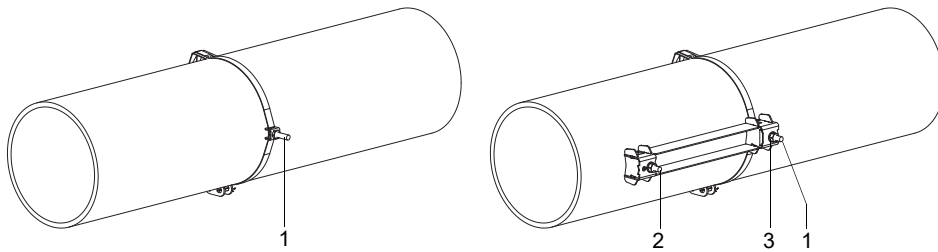

- 1 – tension strap clamp
- 2 – tension strap clamp
- 3 – nut

- Select the installation instruction of the supplied clasp:

Band clamp clasp

- Insert the tension strap into the tension strap clamp (2).
- Place the tension strap around the pipe and insert it into the clasp (see Fig. 6.25 and Fig. 6.26).
- Tighten the tension strap.
- Tighten the clasp screw.
- Tighten the nut of tension strap clamp (2), but not too firmly in order not to damage the tension strap.

Fig. 6.25: Rail on the pipe

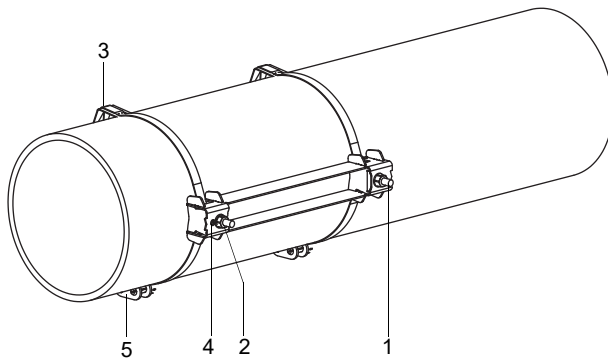

- 1 – tension strap clamp
- 2 – tension strap clamp
- 3 – metal spring
- 4 – nut
- 5 – clasp

Quick release clasp

- Insert the tension strap into its clamp (2) and the metal spring.
- Place the tension strap around the pipe and insert it into the clamp (see Fig. 6.25 and Fig. 6.27).
- Position the metal spring opposite the tension strap clamp (2).
- Tighten the tension strap.
- Tighten the clasp screw.
- Tighten the nut of tension strap clamp (2), but not too firmly in order not to damage the tension strap.

Fig. 6.26: Tension strap with band clamp clasp



1 – clasp screw

Fig. 6.27: Tension strap with quick release clasp and metal spring

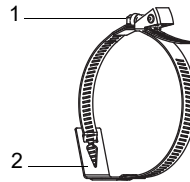

1 – clasp screw
2 – metal spring

Ratchet clasp

- Insert the tension strap into its clamp (2) and the metal spring (see Fig. 6.25 and Fig. 6.28). The metal spring does not have to be mounted on:
 - steel pipes
 - pipes with an outer diameter < 80 mm
 - pipes that are not subjected to significant temperature fluctuations
- Position the ratchet clasp, tension strap clamp (2) and metal spring (if necessary) on the pipe.
- Mount the metal spring opposite the tension strap clamp.
- Place the tension strap around the pipe and pass it through the slot of the clasp screw (see Fig. 6.29).
- Tighten the tension strap.
- Cut off the protruding tension strap (see Fig. 6.29).

Caution!



The edge of the tension strap is very sharp.

- risk of injury
- Debur sharp edges.
 - Wear the required personal protective equipment.
 - Observe the applicable rules.

- Tighten the clasp screw.
- Tighten the nut of the tension strap clamp (2), but not too firmly in order not to damage the tension strap (see Fig. 6.25).

Notice!

In order to release the screw and the tension strap, press the lever down (see Fig. 6.22).

Fig. 6.28: Tension strap with metal spring and clamp



- 1 – metal spring
- 2 – tension strap clamp

Fig. 6.29: Ratchet clasp with tension strap

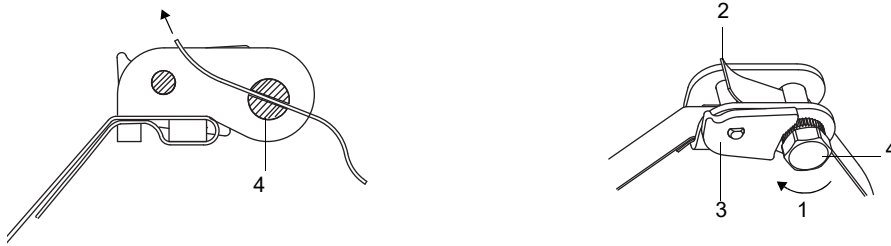

- 1 – sense of rotation
- 2 – edge
- 3 – lever
- 4 – clasp screw with slot

• Repeat the steps to fix the second rail, see Fig. 6.30.

Fig. 6.30: Pipe with 2 rails

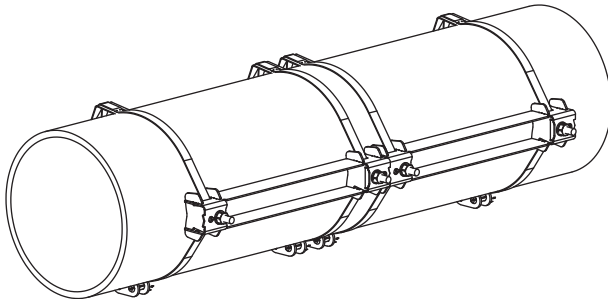

Step 5: Installation of the transducers in the mounting fixture Variofix L

- Press the transducers firmly into their clamping fixtures in the covers until they are tightly fixed. The transducer cables show in opposite directions (see Fig. 6.31).

Notice!

The arrows on the transducers and the covers have to point in the same direction.

Fig. 6.31: Installation of the transducers in the covers

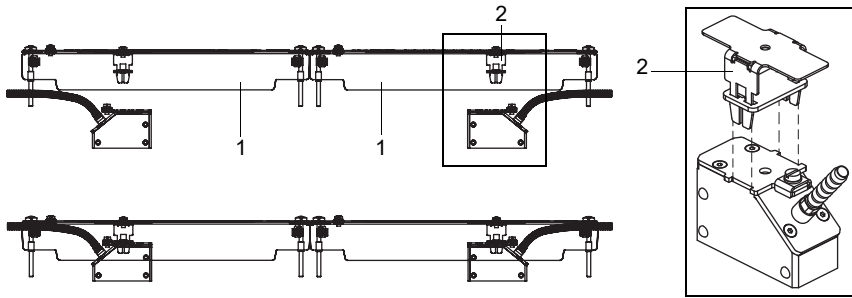

- 1 – cover
- 2 – transducer clamping fixture

- Adjust the transducer distance displayed by the transmitter (see Fig. 6.32).

Fig. 6.32: Adjustment of the transducer distance

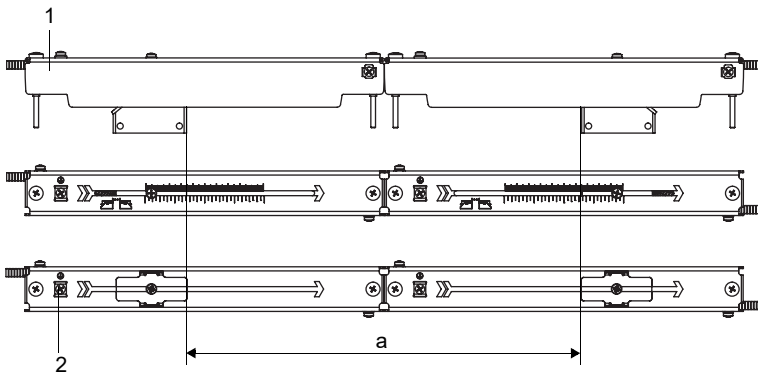

- 1 – cover
- 2 – equipotential bonding terminal
- a – transducer distance

- Fix the transducer cables with the strain relief clamp to protect them from mechanical strain. Transducer cables with stainless steel conduit are fixed inside the housing, transducer cables with plastic conduit are fixed to the outside of the housing, see Fig. 6.33.
- Put coupling foil (or apply some coupling compound for a short-term installation) on the contact surface of the transducers. The coupling foil can be fixed to the contact surface with some coupling compound.
- Put the covers with the transducers on the rails.
- Correct the transducer distance, if necessary.

Fig. 6.33: Fixing the transducer cables

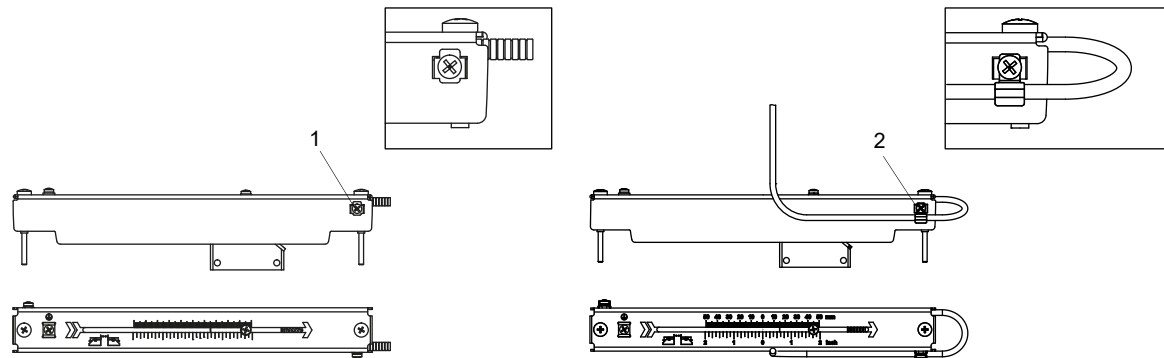

- 1 – strain relief clamp for transducer cable with stainless steel conduit
- 2 – strain relief clamp for transducer cable with plastic conduit

Notice!

Make sure that the coupling foil remains on the contact surface of the transducers. For information concerning the coupling foil, see the safety data sheet.

- Tighten the cover screws, see Fig. 6.34.

Fig. 6.34: Variofix L with transducers on the pipe

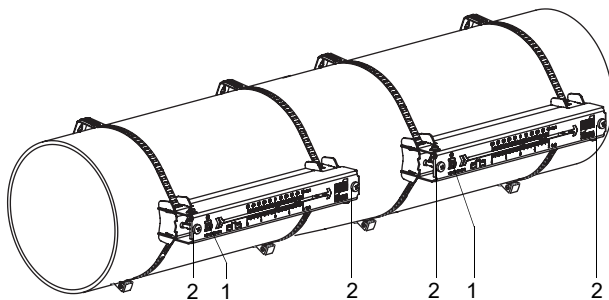

- 1 – equipotential bonding terminal
- 2 – cover screws

6.2.2.5 Mounting with Variofix C

Scope of delivery (example)

Variofix C

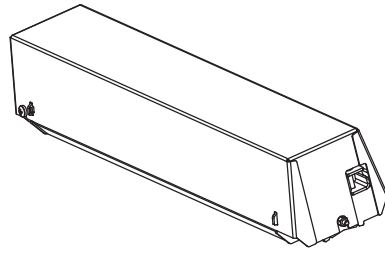

transducer pair

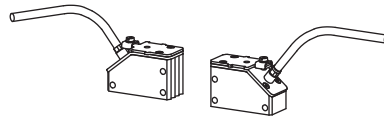

quick release clasp with
tension strap



or

band clamp clasp with
tension strap

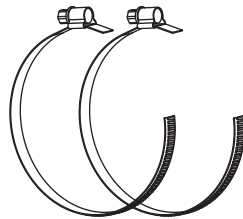

or

tension strap coil

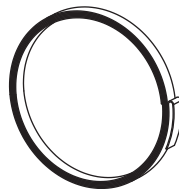

ratchet clasp



Mounting

When measuring in reflection arrangement, 1 transducer mounting fixture is mounted laterally on the pipe.

When measuring in diagonal arrangement, 2 transducer mounting fixtures are mounted on opposite sides of the pipe.

In the following, the installation of 1 transducer mounting fixture in reflection arrangement is described.

Fig. 6.35: Transducer mounting fixture Variofix C (reflection arrangement)

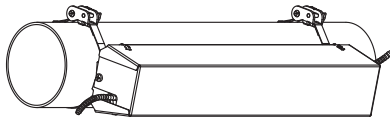
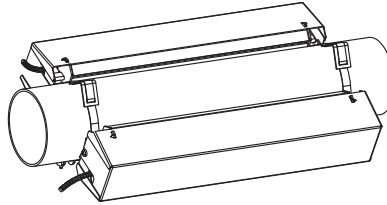

Fig. 6.36: Transducer mounting fixture Variofix C (diagonal arrangement)



Overview of the mounting steps

- **step 1**
disassembly of the transducer mounting fixture Variofix C
- **step 2**
fixation of the clasps to the tension straps
- **step 3**
fixation of the tension strap to the pipe
- **step 4**
fixation of the rail to the pipe
- **step 5**
installation of the transducers in the transducer mounting fixture Variofix C

Step 1: Disassembly of the transducer mounting fixture Variofix C

- Disassemble the transducer mounting fixture Variofix C.

In order to remove the cover from the rail, bend the outer sides of the cover outwards.

In order to remove the spring clip from the rail, slide it over the indentations on the rail and lift it off.

Fig. 6.37: Removal of the cover

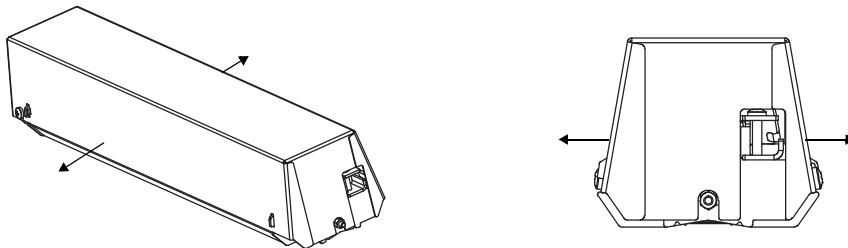
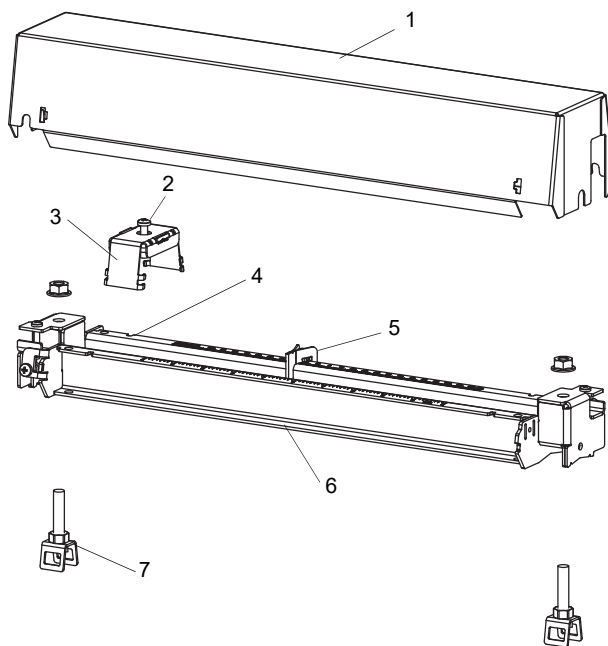

Fig. 6.38: Disassembly of the transducer mounting fixture Variofix C



- 1 – cover
- 2 – tensioning screw
- 3 – spring clip
- 4 – indentation
- 5 – spacing element
- 6 – rail
- 7 – tension strap clamp

Step 2: Fixation of the clasps to the tension straps

- Select the installation instruction of the supplied clasp:

Band clamp clasp

The clasp is fixed to the tension strap (see Fig. 6.39).

Quick release clasp

The clasp is fixed to the tension strap (see Fig. 6.40).

- Cut the tension strap to length (pipe circumference + at least 120 mm).

Fig. 6.39: Band clamp clasp with tension strap

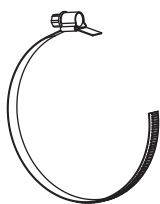
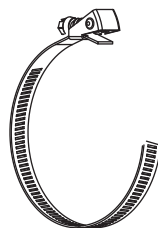

Fig. 6.40: Quick release clasp with tension strap



Ratchet clasp

- Cut the tension strap to length (pipe circumference + at least 120 mm).

Caution!

The edge of the tension strap is very sharp.

risk of injury

- Debur sharp edges.
- Wear the required personal protective equipment.
- Observe the applicable rules.

- Insert approx. 100 mm of the tension strap into part (1) and (2) of the ratchet clasp (see Fig. 6.41 a).
- Bend the tension strap.
- Insert the tension strap into part (1) of the ratchet clasp (see Fig. 6.41 b).
- Tighten the tension strap.
- Repeat the steps for the second tension strap.

Fig. 6.41: Ratchet clasp with tension strap

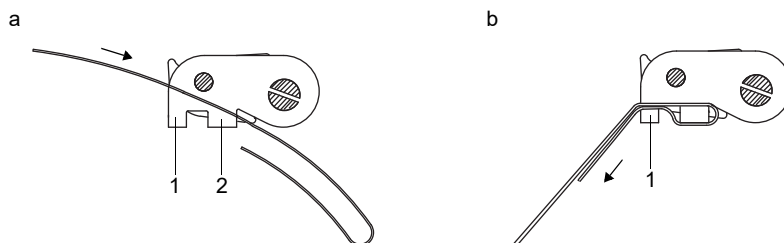
**Step 3: Fixation of the tension strap to the pipe**

One tension strap is fixed to the pipe. The second tension strap will be mounted later.

Fig. 6.42: Tension strap with clamp and metal spring on the pipe

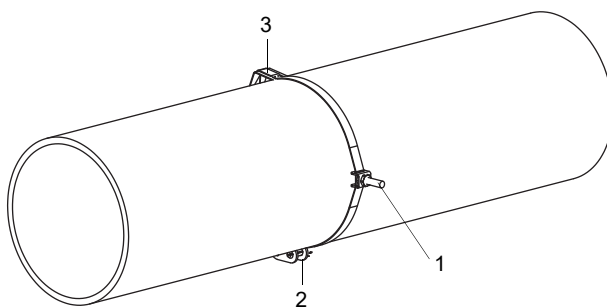

- 1 – tension strap clamp
- 2 – clasp
- 3 – metal spring

Select the installation instruction of the supplied clasp:

Band clamp clasp

- Insert the tension strap into its clamp (see Fig. 6.43).
- Position the clasp and the tension strap clamp on the pipe (see Fig. 6.42). On a horizontal pipe, mount the tension strap clamp laterally to the pipe, if possible.
- Place the tension strap around the pipe and insert it into the clasp (see Fig. 6.45).
- Tighten the tension strap.
- Tighten the clasp screw.

Quick release clasp

- Insert the tension strap into its clamp and the metal spring (see Fig. 6.43 and Fig. 6.44).
- Position the clasp, the tension strap clamp and the metal spring on the pipe (see Fig. 6.42):
 - On a horizontal pipe, mount the tension strap clamp laterally to the pipe, if possible.
 - Mount the metal spring opposite the tension strap clamp.

Fig. 6.43: Tension strap with clamp

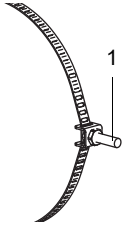

1 – tension strap clamp

Fig. 6.44: Tension strap with quick release clasp and metal spring

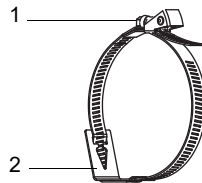

1 – clasp screw
2 – metal spring

Fig. 6.45: Tension strap with band clamp clasp



1 – clasp screw

- Place the tension strap around the pipe and insert it into the clasp (see Fig. 6.44).
- Tighten the tension strap.
- Tighten the clasp screw.

Ratchet clasp

- Insert the tension strap into its clamp and the metal spring (see Fig. 6.46). The metal spring does not have to be mounted on:
 - steel pipes
 - pipes with an outer diameter < 80 mm
 - pipes that are not subjected to significant temperature fluctuations
- Position the ratchet clasp, tension strap clamp and metal spring (if necessary) on the pipe (see Fig. 6.42):
 - On a horizontal pipe, mount the tension strap clamp laterally to the pipe, if possible.
 - Mount the metal spring (if necessary) opposite the tension strap clamp.
- Place the tension strap around the pipe and pass it through the slot of the clasp screw (see Fig. 6.47).
- Tighten the tension strap.
- Cut off the protruding tension strap (see Fig. 6.47).

Caution!



The edge of the tension strap is very sharp.

risk of injury

- Debur sharp edges.
- Wear the required personal protective equipment.
- Observe the applicable rules.

- Tighten the clasp screw.

Notice!

In order to release the screw and the tension strap, press the lever down (see Fig. 6.47).

Fig. 6.46: Tension strap with metal spring and clamp



- 1 – metal spring
- 2 – tension strap clamp

Fig. 6.47: Ratchet clasp with tension strap

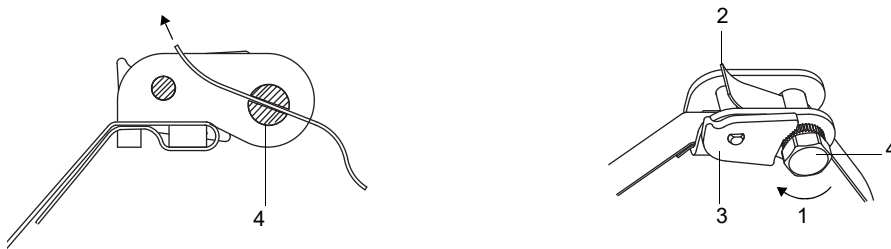

- 1 – sense of rotation
- 2 – edge
- 3 – lever
- 4 – clasp screw with slot

Step 4: Fixation of the rail to the pipe

- Place the tension strap clamp (2) in the rail (see Fig. 6.48). Observe the orientation of the tension strap clamp.
- Slightly tighten the nut of the tension strap clamp (2).
- Screw the rail to tension strap clamp (1) (see Fig. 6.49).
- Tighten the nut of tension strap clamp (1), but not too firmly in order not to damage the tension strap.

Fig. 6.48: Rail with tension strap clamp

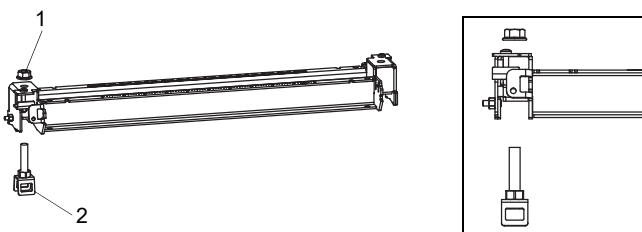

- 1 – nut
- 2 – tension strap clamp

Fig. 6.49: Rail, fixed on one side to the pipe

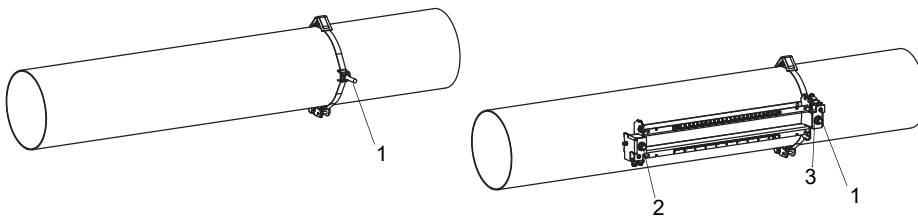

- 1 – tension strap clamp
- 2 – tension strap clamp
- 3 – nut

- Select the installation instruction of the supplied clasp:

Band clamp clasp

- Insert the tension strap into the tension strap clamp (2).
- Place the tension strap around the pipe and insert it into the clasp (see Fig. 6.50 and Fig. 6.51).
- Tighten the tension strap.
- Tighten the clasp screw.
- Tighten the nut of tension strap clamp (2), but not too firmly in order not to damage the tension strap. The rail has to be firmly fixed to the pipe.

Fig. 6.50: Rail on the pipe

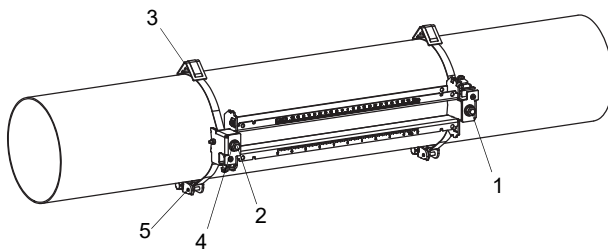

- 1 – tension strap clamp
- 2 – tension strap clamp
- 3 – metal spring
- 4 – nut
- 5 – clasp

Quick release clasp

- Insert the tension strap into its clamp (2) and the metal spring.
- Place the tension strap around the pipe and insert it into the clasp (see Fig. 6.50 and Fig. 6.52).
- Position the metal spring opposite the tension strap clamp (2).
- Tighten the tension strap.
- Tighten the clasp screw.
- Tighten the nut of tension strap clamp (2), but not too firmly in order not to damage the tension strap.

Fig. 6.51: Tension strap with band clamp clasp



- 1 – clasp screw

Fig. 6.52: Tension strap with quick release clasp and metal spring

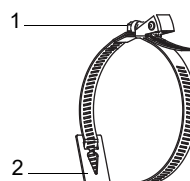

- 1 – clasp screw
- 2 – metal spring

Ratchet clasp

- Insert the tension strap into its clamp (2) and the metal spring (see Fig. 6.50 and Fig. 6.53). The metal spring does not have to be mounted on:
 - steel pipes
 - pipes with an outer diameter < 80 mm
 - pipes that are not subjected to significant temperature fluctuations
- Position the ratchet clasp, tension strap clamp (2) and metal spring (if necessary) on the pipe.
- Mount the metal spring opposite the tension strap clamp.
- Place the tension strap around the pipe and pass it through the slot of the clasp screw (see Fig. 6.54).
- Tighten the tension strap.
- Cut off the protruding tension strap (see Fig. 6.54).

Caution!

The edge of the tension strap is very sharp.

risk of injury

- Debur sharp edges.
- Wear the required personal protective equipment.
- Observe the applicable rules.

- Tighten the clasp screw.
- Tighten the nut of the tension strap clamp (2), but not too firmly in order not to damage the tension strap (see Fig. 6.50).

Notice!

In order to release the screw and the tension strap, press the lever down (see Fig. 6.54).

Fig. 6.53: Tension strap with metal spring and clamp



- 1 – metal spring
- 2 – tension strap clamp

Fig. 6.54: Ratchet clasp with tension strap

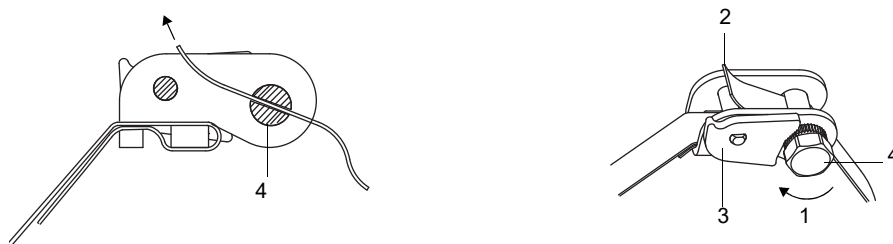

- 1 – sense of rotation
- 2 – edge
- 3 – lever
- 4 – clasp screw with slot

Step 5: Installation of the transducers in the mounting fixture Variofix C

- Put coupling foil (or apply some coupling compound for a short-term installation) on the contact surface of the transducers. The coupling foil can be fixed to the contact surface with a small amount of coupling compound.

Notice!

If the signal is not sufficient for the measurement, use coupling compound instead of coupling foil. For information concerning the coupling foil or coupling compound, see the safety data sheet.

- Position the transducers on the rail in such a way that the engravings on them form an arrow. The transducer cables show in opposite directions (see Fig. 6.55).
- Adjust the transducer distance displayed by the transmitter (see Fig. 6.55).
- Slide the spring clips on the transducers (see Fig. 6.57).
- Fix the transducers by slightly tightening the tensioning screws. The end of each tensioning screw has to be placed above the hole in the respective transducer (see Fig. 6.55 and Fig. 6.57).
- Correct the transducer distance, if necessary.
- Tighten the tensioning screws until the collar of the rivet nut is flush with the mounting bracket, see Fig. 6.56.
- Fix the spacing elements on the rail to mark the transducer position (see Fig. 6.55).
- Use the cable fixture to fix the transducer cables in order to protect them from mechanical strain (see Fig. 6.57).
- Put the cover on the rail (see Fig. 6.58).
- Tighten the screws (2) on both sides of the cover (see Fig. 6.58).

Fig. 6.55: Transducers in the rail (spring clip not shown)

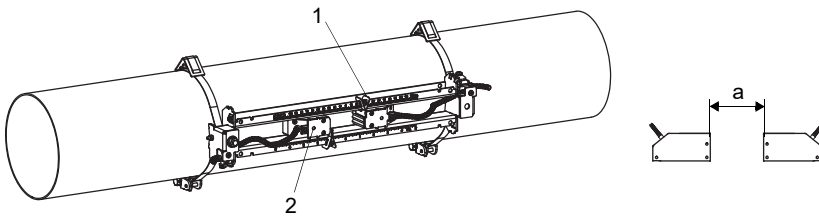

- 1 – spacing element
- 2 – hole
- a – transducer distance

Fig. 6.56: Spring clip

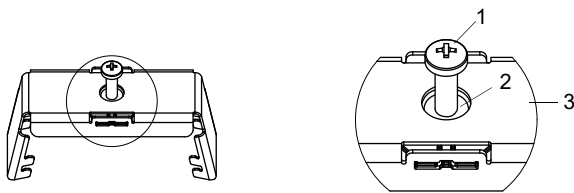

- 1 – tensioning screw
- 1 – rivet nut
- 2 – mounting bracket

Fig. 6.57: Transducers in rail

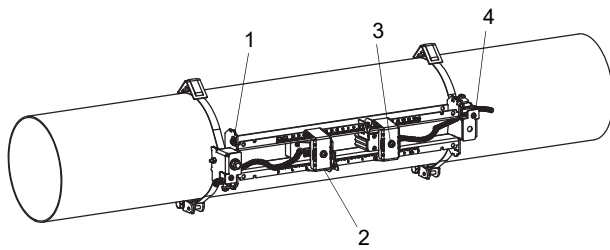

- 1 – equipotential bonding terminal
- 2 – spring clip
- 3 – tensioning screw
- 4 – cable fixture

Fig. 6.58: Variofix C with transducers on the pipe

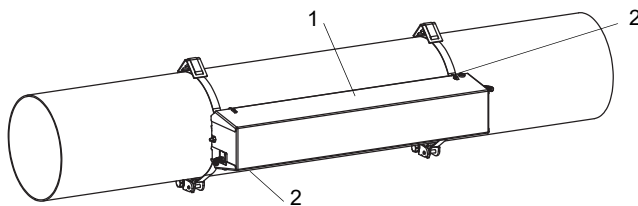

- 1 – cover
- 2 – screw

Remove the cover from the mounted transducer mounting fixture Variofix C as follows:

- Loosen the screws (see Fig. 6.58).
- Use a lever tool to remove the cover.
- Insert the lever tool (max. 3 mm) in one of the 4 openings of the cover (see Fig. 6.59).
- Press the lever tool against the fixture.
- Bend the cover outwards and release it from the anchoring.
- Repeat the steps for the other 3 openings.
- Remove the cover from the rail.

Fig. 6.59: Cover removal

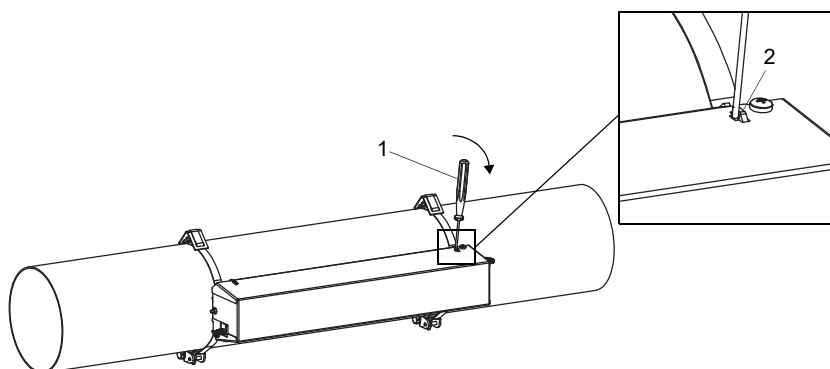

- 1 – lever tool
- 2 – support

6.2.2.6 Installation with mounting shoe and band clamp clasp

- Insert the tension strap into the groove on the upper side of the mounting shoe.
- Position the mounting shoe and the clasp on the pipe. On horizontal pipes, mount the mounting shoe laterally to the pipe, if possible.
- Place the tension strap around the pipe and insert it into the clasp.
- Tighten the tension strap.
- Tighten the screw of the clasp.

Notice!

The clasp has to be completely in contact with the pipe to ensure a good fixation.

- Repeat the steps for fixing the second mounting shoe.
- Adjust the displayed transducer distance between the inner edges of the mounting shoes by means of the measuring tape.
- Tighten the screws of the clasps.
- Slide the transducer into the mounting shoe.
- Press the transducer firmly on the pipe. There must not be a gap or any air pockets between the transducer surface and the pipe wall. Tighten the screw of the mounting shoe.
- Repeat the steps for the second transducer.

Fig. 6.60: Transducer in the mounting shoe, installed with tension strap and clasp

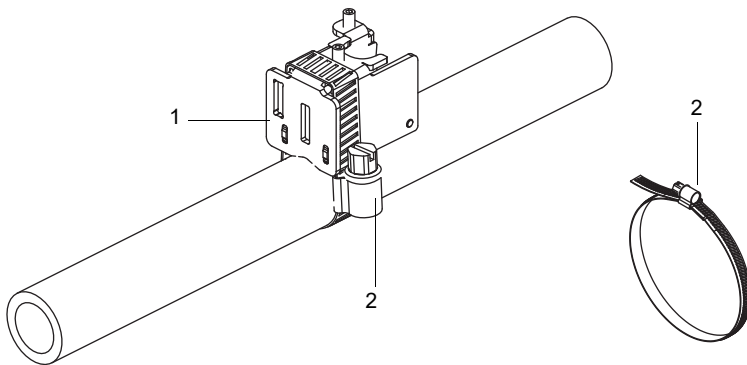

- 1 – mounting shoe
- 2 – tension strap

Notice!

If the transducers are mounted on a vertical pipe and the transmitter is placed lower than the transducers, the transducer cables should be fixed to the tension strap by a cable tie to protect them from mechanical strain.

6.2.2.7 Mounting with PermaLok

Scope of delivery

2 × PermaLok

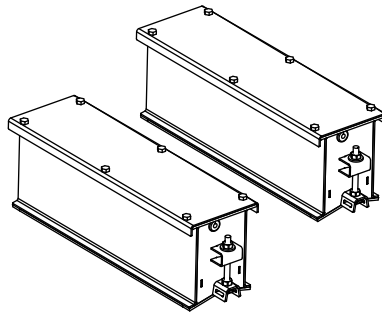

1 × transducer pair

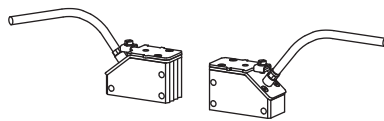

4 × quick release clasp with tension strap

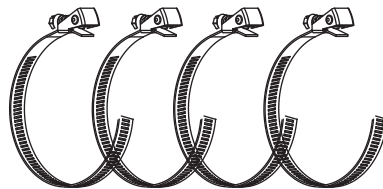
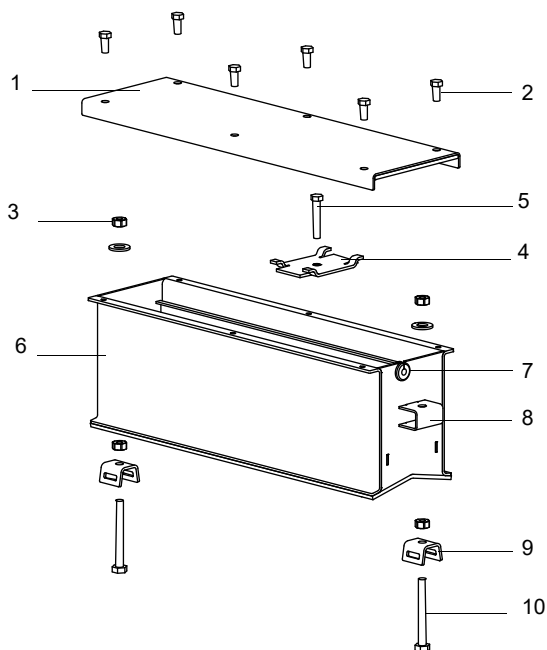

Fig. 6.61: PermaLok components



- 1 – cover
- 2 – screw
- 3 – nut
- 4 – slider
- 5 – screw of the slider
- 6 – rail
- 7 – cable bushing
- 8 – support
- 9 – tension strap clamp (optional)
- 10 – bolt (optional)

Mounting

When measuring in diagonal arrangement, the transducer mounting fixtures are mounted on opposite sides of the pipe, see Fig. 6.62. When measuring in reflection arrangement, the transducer mounting fixtures are mounted on the same side of the pipe, see Fig. 6.63.

In the following, the mounting of 2 transducer mounting fixtures in reflection arrangement is described (1 transducer mounting fixture for each transducer).

Fig. 6.62: Transducer mounting fixture PermaLok (diagonal arrangement)

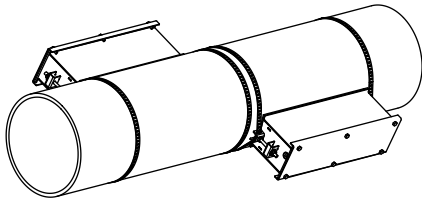
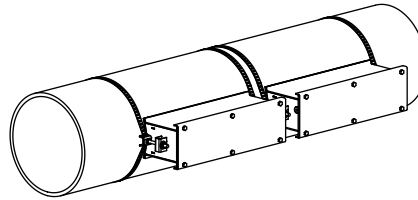

Fig. 6.63: Transducer mounting fixture PermaLok (reflection arrangement)



Overview of installation steps

- **step 1**
preparation
- **step 2**
fixation of the rail to the pipe
- **step 3**
mounting of the transducers in the mounting fixture PermaLok

Step 1: Preparation

- Remove the cover and slider of the PermaLok rail.
 - Cut the tension strap to length (pipe circumference + 120 mm).
- The clasp is fixed to the tension strap (see Fig. 6.15).

Fig. 6.64: Quick release clasp with tension strap

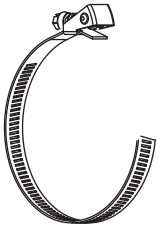

Step 2: Fixation of the rail to the pipe

- Insert the tension strap through the slot of the tension strap clamp (if present, see Fig. 6.65) or through the rail fixture, see Fig. 6.66.

Fig. 6.65: Tension strap through tension strap clamp

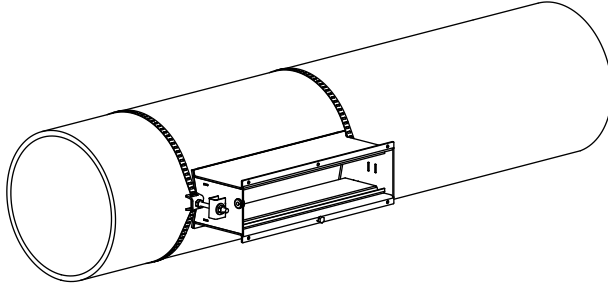
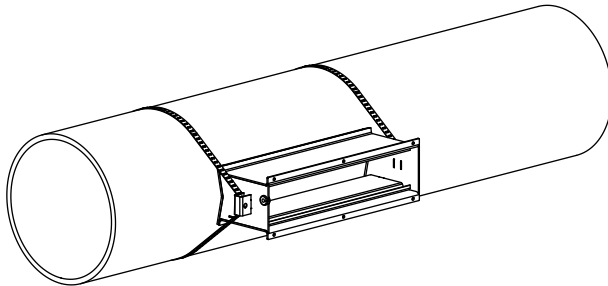

Fig. 6.66: Tension strap through rail fixture



- Position the clasp on the pipe.
- Make sure, the clasp rests flatly along the pipe.
- Place the tension strap around the pipe and insert it into the clasp.
- Tighten the tension strap.
- Tighten the clasp screw.
- Repeat the steps for the second tension strap, but do not tighten too firmly.

Before fixing the rail to the pipe, it has to be assured that the rail and the pipe are aligned in parallel position.

- Repeat the steps for the second rail, see Fig. 6.67.

Fig. 6.67: Pipe with 2 rails

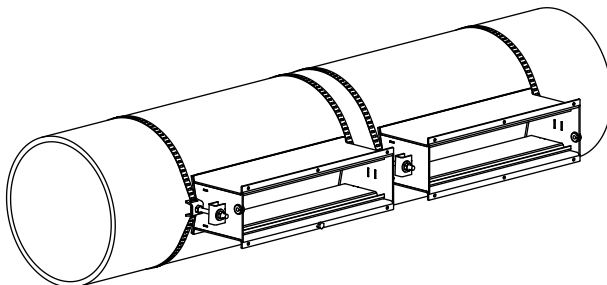

Step 3: Mounting of the transducers in the mounting fixture PermaLok

- Stick coupling foil (or apply some coupling compound for a short-term installation) on the contact surface of the transducer. The coupling foil can be fixed to the contact surface with a small amount of coupling compound.
- Insert the transducer into the rail.
- Position the slider on the transducer. The screw of the slider has to fit into the dugout on the top of the transducer, see Fig. 6.31.

Fig. 6.68: Installation of the transducers

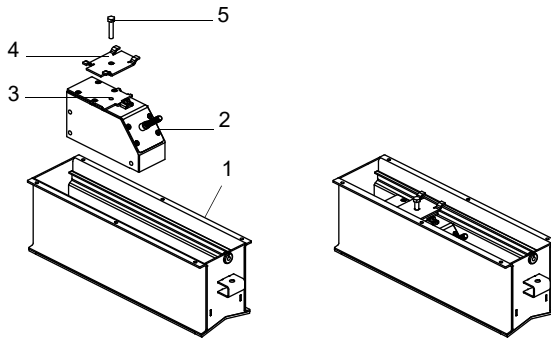

- 1 – rail
- 2 – transducer
- 3 – dugout
- 4 – slider
- 5 – screw of the slider

- Repeat the steps for the second transducer.
- Position the transducers on the rail in such a way that the engravings on them form an arrow. The transducer cables show in opposite directions.
- Adjust the transducer distance displayed by the transmitter (see Fig. 6.69).
- Tighten the screw of the slider until the transducers are firmly pressed to the pipe surface.
- Measure once again the transducer distance. Correct it, if necessary.
- Pass the transducer cables through the cable bushing to protect them from mechanical strain.
- Check the transducer distance as described in section 9.3.
- Check transmitter for signal, then put the cover on the rail.
- Tighten the screws of the cover.

Fig. 6.69: Adjustment of the transducer distance

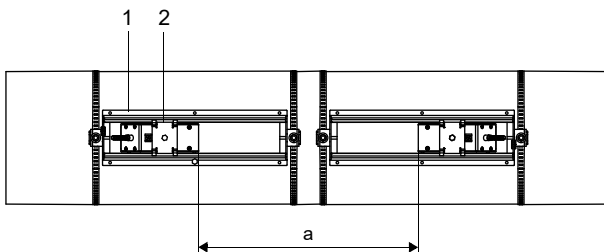

- 1 – rail
- 2 – slider
- a – transducer distance

6.2.2.8 Mounting with tension strap and quick release clasp

Caution!



The edge of the tension strap is very sharp.

Risk of injury.

- Debur sharp edges.
- Wear the required personal protective equipment.
- Observe the applicable rules.

- Cut the tension strap to length (pipe circumference + at least 120 mm).
- Make sure that part (2) of the clasp is on top of part (1), see Fig. 6.70 a. The hooks of part (2) have to be on the outer side of the clasp.
- Pull approx. 20 mm of the tension strap through the slot of the clasp to fix the clasp to the tension strap, see Fig. 6.70 b.
- Bend the end of the tension strap.
- Position the transducer on the pipe, see Fig. 6.71.
- Place the tension strap around the transducer and the pipe.
- Push the tension strap through part (2) and (1) of the clasp.
- Tighten the tension strap and engage it in the inner hook of the clasp.
- Tighten the screw of the clasp.

Fig. 6.70: Clasp



Fig. 6.71: Transducer on the pipe

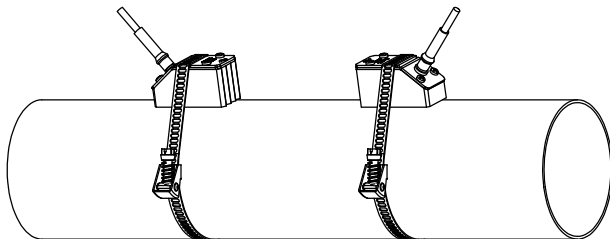

6.2.2.9 Fixation of PermaLok with solid band strap kit

- Cut the tension strap to length (pipe circumference + at least 305 mm).
- Insert the solid band through the slot of the tension strap clamp.
- Line up the solid band, screw and tension strap clamp. Line up the solid band, bolt and tension strap clamp observing the left and right side of the PermaLok, see Fig. 6.72.

Fig. 6.72:



- 1 – left tension strap clamp
- 2 – right tension strap clamp
- 3 – clip for fixation of the solid band

- Insert 25 mm of the solid band through the slot of the clip. Bend it back and press it with pliers, see Fig. 6.73.

Fig. 6.73



- Place the solid band around the pipe.
- Position the clip as shown in Fig. 6.74.
- Insert the other end of the solid band through the slot of the clip, see Fig. 6.75.

Fig. 6.74



Fig. 6.75



- Hold the tabs of the clip using pliers and pull the solid band completely through the slot of the clip, see Fig. 6.76.
- Bend the end of the solid band back over the set of teeth, see Fig. 6.77.

Fig. 6.76



Fig. 6.77



- Fold the tabs of the clip over the solid band and cut the protruding band off, see Fig. 6.78.

Fig. 6.78



- Position the tension strap clamp on the opposite side of the clip.
- Measure the distance x , see Fig. 6.79. Repeat the steps for the second band and place it at the measured distance x to the other.
- Measure the distance x , see Fig. 6.79. Repeat the steps for the second tension strap and attach it to the tube at the measured distance x .

Fig. 6.79

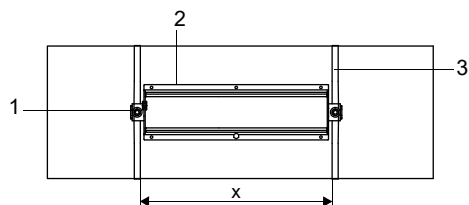

- 1 – tension strap clamp
- 2 – rail
- 3 – solid band

- Mount the PermaLok onto the tension strap clamp and tighten the screws.
- Insert the transducers into the PermaLok as described in the section 6.2.2.7.

6.3 Temperature probe

6.3.1 Pipe preparation

Caution!



Contact with grinding dust

This may result in injuries (e.g., breathing difficulties, skin reactions, eye irritations).

- Wear the required personal protective equipment.
- Observe the applicable rules.

Important!

The pipe has to be sufficiently stable to withstand the pressure exerted by the temperature probe.

Rust, paint or deposits on the pipe thermally insulate the measuring point. A good thermal contact between the pipe and the temperature probe is obtained as follows:

- Clean the pipe at the selected measuring point.
 - Remove any insulation material, rust or loose paint.
 - If present, the paint layer has to be smoothed by grinding. The paint does not need to be removed completely.
- Use coupling foil or apply a layer of thermal conductivity paste or coupling compound on the contact surface of the temperature probe. Observe the specific ambient temperature.
- Observe that there must be no air pockets between the contact surface of the temperature probe and the pipe wall.

6.3.2 Installation of the temperature probe (response time 50 s)

Notice!

The temperature probe has to be thermally insulated.

Select the installation instruction of the supplied clasp:

6.3.2.1 Installation with clasp

Caution!



The edge of the tension strap is very sharp.

Risk of injury!

- Debur sharp edges.
- Wear the required personal protective equipment.
- Observe the applicable rules.

- Cut the tension strap to length (pipe circumference + at least 120 mm).
- Make sure that part (2) of the clasp is on top of part (1) (see Fig. 6.80 a). The hooks of part (2) have to be on the outer side of the clasp.
- Pull approx. 20 mm of the tension strap through the slot of the clasp to fix the clasp to the tension strap (see Fig. 6.80 b).
- Bend the end of the tension strap.
- Position the temperature probe on the pipe (see Fig. 6.81).
- Place the tension strap around the temperature probe and the pipe.
- Push the tension strap through part (2) and (1) of the clasp.
- Tighten the tension strap and engage it in the inner hook of the clasp.
- Tighten the screw of the clasp.

Fig. 6.80: Clasp

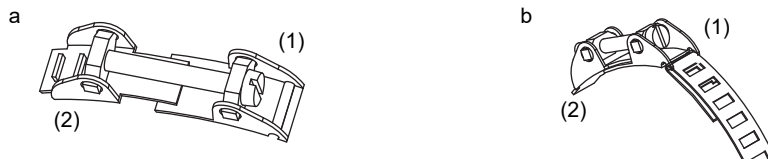
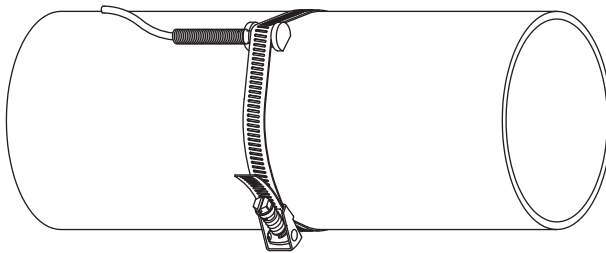

Fig. 6.81: Temperature probe on the pipe



6.3.2.2 Installation with FLEXIM clasp

Caution!



The edge of the tension strap is very sharp.

Risk of injury!

- Debur sharp edges.
- Wear the required personal protective equipment.
- Observe the applicable rules.

- Cut the tension strap to length (pipe circumference + at least 120 mm).
- Insert approx. 20 mm of the tension strap into the slot of the clasp.
- Bend the end of the tension strap.
- Position the temperature probe on the pipe (see Fig. 6.81).
- Place the tension strap around the temperature probe and the pipe.
- Push the tension strap through part (2) and (1) of the clasp.
- Tighten the tension strap and engage it in the inner hook of the clasp.
- Tighten the screw of the clasp.

Fig. 6.82: FLEXIM clasp

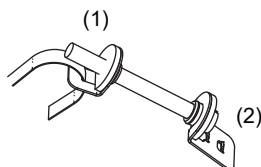

6.3.2.3 Installation with quick release clasp

Caution!



The edge of the tension strap is very sharp.

Risk of injury!

- Debur sharp edges.
- Wear the required personal protective equipment.
- Observe the applicable rules.

- Cut the tension strap to length (pipe circumference + at least 120 mm).
- Position the temperature probe on the pipe (see Fig. 6.81).
- Place the tension strap around the temperature probe and the pipe.
- Insert the tension strap into the clasp.
- Tighten the tension strap.
- Tighten the screw of the clasp.

Fig. 6.83: Quick release clasp



6.3.3 Installation of the temperature probe (response time 8 s)

- Fix the protection plate and the insulation foam to the temperature probe, see Fig. 6.84.
- Take the spring end of the chain and insert the first ball into one of the slots on the upper side of the temperature probe, see Fig. 6.85.
- Place the chain around the pipe.
- Tighten the chain and insert it into the other slot of the temperature probe.

Fig. 6.84: Temperature probe

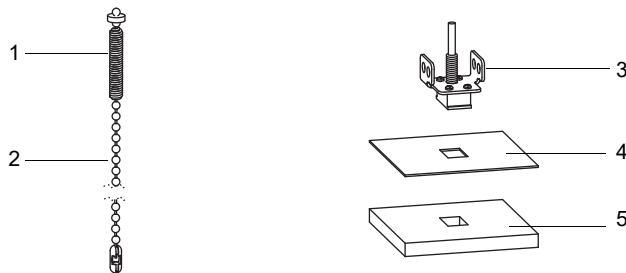

- 1 – spring end
- 2 – chain
- 3 – temperature probe
- 4 – protection plate
- 5 – insulation foam

Notice!

The entire contact surface of the temperature probe always has to rest on the pipe. In case of very small pipes, the protection plate and the insulation foam have to be cut to size, if necessary.

Fig. 6.85: Temperature probe on the pipe

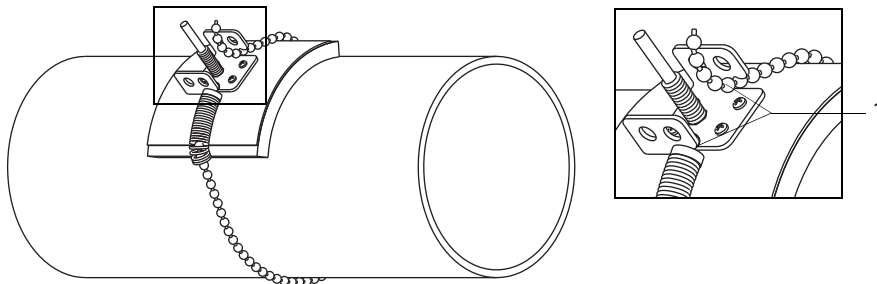

- 1 – slots on the upper side of the temperature probe

7 Connection

Danger!



Risk of explosion when using the measuring equipment in explosive atmospheres

This may result in personal or material damage or dangerous situations.

→ Observe the "Safety instructions for the use in explosive atmospheres".

Warning!



Installation, connection and start-up by unauthorized and unqualified personnel

This may result in personal or material damage or dangerous situations.

→ Any work on the transmitter has to be carried out by authorized and qualified personnel.

Danger!



Working in mines or cramped confines

Risk of intoxication and/or asphyxiation because of emerging gases, risk of injuries because of cramped conditions.

→ Wear the required personal protective equipment.

→ Observe the applicable rules.

Warning!



Touching live parts

Electric shock or arc faults can lead to severe injuries. The measuring equipment can be damaged.

→ Prior to any work on the transmitter (e.g., installation, dismantling, connection, start-up), the transmitter has to be disconnected from the power supply. It is not sufficient to remove the internal fuse of the instrument.

Caution!



Safety and accident prevention regulations for electrical systems and equipment

Failure to observe these regulations may lead to severe injuries.

→ Observe the safety and accident prevention regulations for electrical systems and equipment.

7.1 Transducers

It is recommended to run the cables from the measuring point to the transmitter before connecting the transducers to avoid load on the connectors.

Notice!
If transducers are replaced or added, the SENSPROM has to be replaced or added as well.

Fig. 7.1: Connection of the transducers to the transmitter

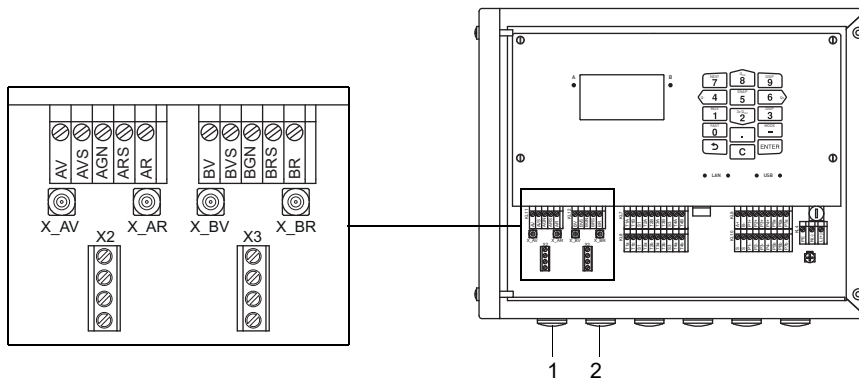

- 1 – transducers (measuring channel A)
- 2 – transducers (measuring channel B)

7.1.1 Connection of the transducer cable to the transmitter

Important!
The degree of protection of the transmitter is only ensured if all cables are tightly fitted using cable glands and the housing is firmly screwed.

7.1.1.1 Transducer cable with SMB connectors

- Remove the blind plug for the connection of the transducer cable.
- Insert the transducer cable with the SMB connectors into the housing.
- Fix the transducer cable by tightening the cable gland.
- Connect the SMB connectors to the sockets of the transmitter.

Tab. 7.1: Terminal assignment

terminal	connection
X_xV	SMB connector (brown cable, marked white)
X_xR	SMB connector (brown cable, marked black)

Fig. 7.2: Connection of the transducer cable with SMB connectors to the transmitter

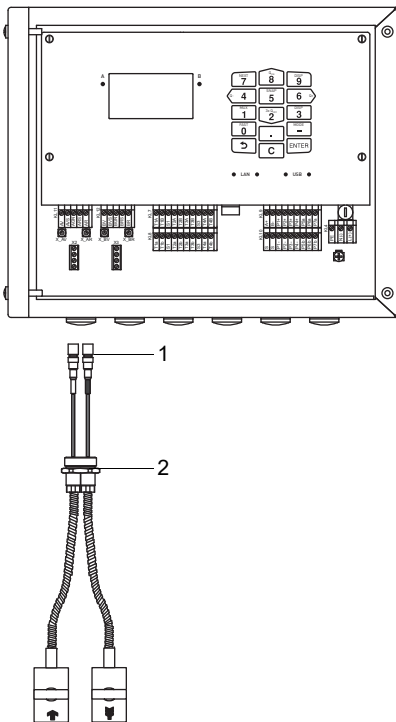

- 1 – SMB connector
- 2 – cable gland

7.1.1.2 Transducer cable with plastic jacket and stripped ends

- Remove the blind plug for the connection of the transducer cable.
- Open the cable gland of the transducer cable. The compression part remains in the cap nut.
- Push the transducer cable through the cap nut and the compression part.
- Prepare the transducer cable.
- Cut the external shield to length and brush it back over the compression part.
- Screw the sealing ring side of the basic part into the transmitter housing.
- Insert the transducer cable into the housing.

Notice!

For good electromagnetic compatibility (EMC), it is important to ensure good electrical contact between the external shield and the cap nut (and thus the housing).

- Fix the cable gland by screwing the cap nut onto the basic part.
- Connect the transducer cable to the terminals of the transmitter.

Tab. 7.2: Terminal assignment





terminal	connection
xV	transducer  (core)
xVS	transducer  (internal shield)
xRS	transducer  (internal shield)
xR	transducer  (core)

Fig. 7.3: Connection of the transducer cable with plastic jacket and stripped ends to the transmitter



- 1 – cap nut
- 2 – compression part
- 3 – basic part
- 4 – external shield, brushed back

7.1.1.3 Transducer cable with stainless steel conduit and stripped ends

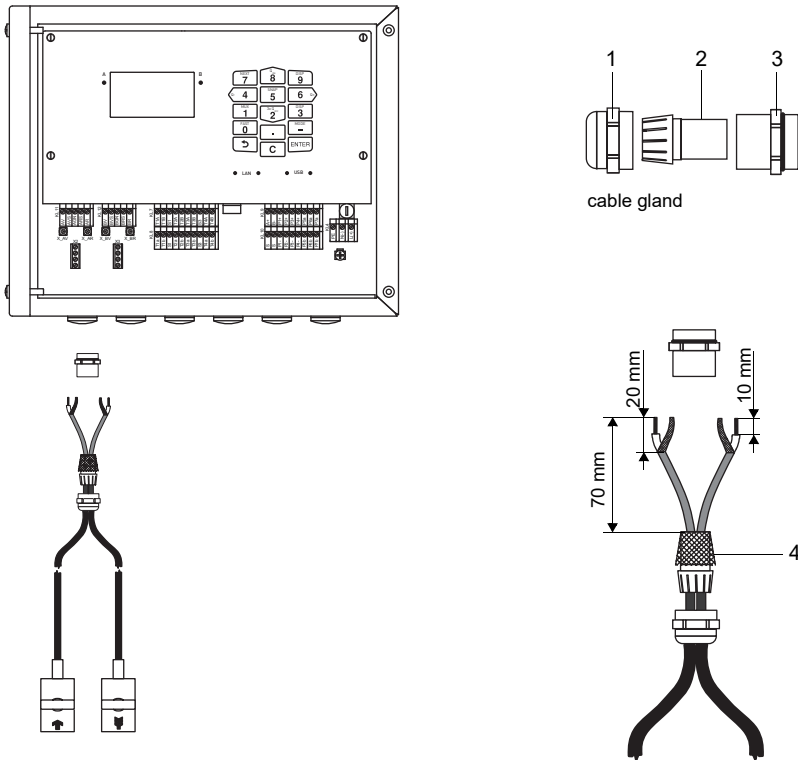
- Remove the blind plug for the connection of the transducer cable.
- Insert the transducer cable into the housing.
- Fix the transducer cable by tightening the cable gland.
- Connect the transducer cable to the terminals of the transmitter.

Tab. 7.3: Terminal assignment





terminal	connection
xV	transducer  (brown cable, marked white)
xVS	transducer  (red cable)
xRS	transducer  (red cable)
xR	transducer  (brown cable)

Fig. 7.4: Connection of the transducer cable with stainless steel conduit and stripped ends to the transmitter



1 – cable gland

7.1.2 Connection of the extension cable to the transmitter

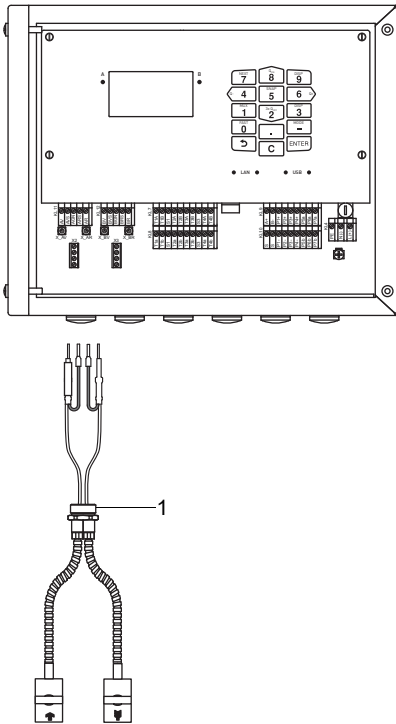
The extension cable is connected to the transmitter via the transducer connection.

- Remove the blind plug for the connection of the transducer cable.
- Open the cable gland of the extension cable. The compression part remains in the cap nut.
- Push the extension cable through the cap nut and the compression part.
- Prepare the extension cable.
- Cut the external shield to length and brush it back over the compression part.
- Screw the sealing ring side of the basic part into the transmitter housing.
- Insert the extension cable into the housing.

Notice!

For good electromagnetic compatibility (EMC), it is important to ensure good electrical contact between the external shield and the cap nut (and thus the housing).

- Fix the cable gland by screwing the cap nut onto the basic part.
- Connect the extension cable to the terminals of the transmitter.

Tab. 7.4: Terminal assignment

terminal	connection
xV	white or marked cable (core)
xVS	white or marked cable (internal shield)
xRS	brown cable (internal shield)
xR	brown cable (core)

Fig. 7.5: Connection of the extension cable to the transmitter

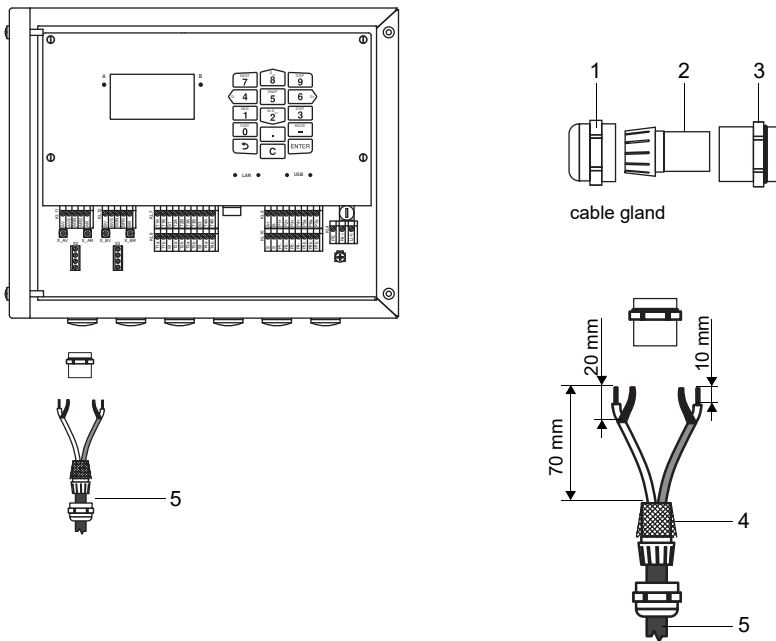

- 1 – cap nut
- 2 – compression part
- 3 – basic part
- 4 – external shield, brushed back
- 5 – extension cable

7.1.3 Connection of the transducer cable to the junction box

7.1.3.1 Transducer cable with SMB connectors

- Remove the blind plug for the connection of the transducer cable.
- Insert the transducer cable with the SMB connectors into the junction box.
- Fix the transducer cable by tightening the cable gland.
- Connect the SMB connectors to the sockets of the junction box.

Tab. 7.5: Terminal assignment

terminal	connection
XV	SMB connector (brown cable, marked white)
XR	SMB connector (brown cable, marked black)

Fig. 7.6: Connection of the transducer cable with SMB connectors

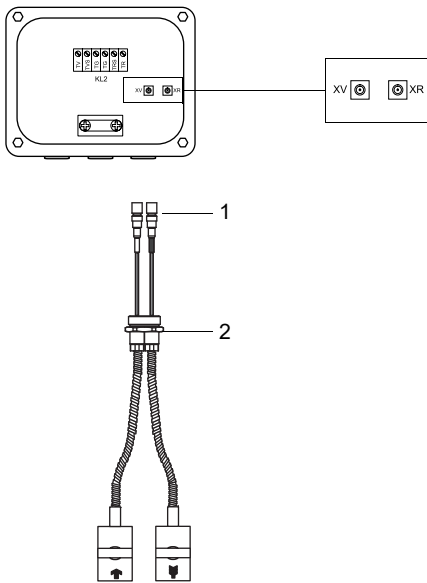

- 1 – SMB connector
- 2 – cable gland

7.1.3.2 Transducer cable with plastic jacket and stripped ends

- Remove the blind plug for the connection of the transducer cable.
- Open the cable gland of the transducer cable. The compression part remains in the cap nut.
- Push the transducer cable through the cap nut and the compression part.
- Prepare the transducer cable.
- Shorten the external shield and brush it back over the compression part.
- Screw the gasket ring side of the basic part into the junction box.
- Insert the transducer cable into the junction box.

Notice!

For good electromagnetic compatibility (EMC), it is important to ensure good electrical contact between the external shield and the cap nut (and thus the housing).

- Fix the cable gland by screwing the cap nut onto the basic part.
- Connect the transducer cable to the terminals of the junction box.

Tab. 7.6: Terminal assignment





terminal	connection
V	transducer  (core)
VS	transducer  (internal shield)
RS	transducer  (internal shield)
R	transducer  (core)

Fig. 7.7: Connection of the transducer cable with plastic jacket and stripped ends



- 1 – cap nut
- 2 – compression part
- 3 – basic part
- 4 – external shield, brushed back

7.1.3.3 Transducer cable with stainless steel conduit and stripped ends

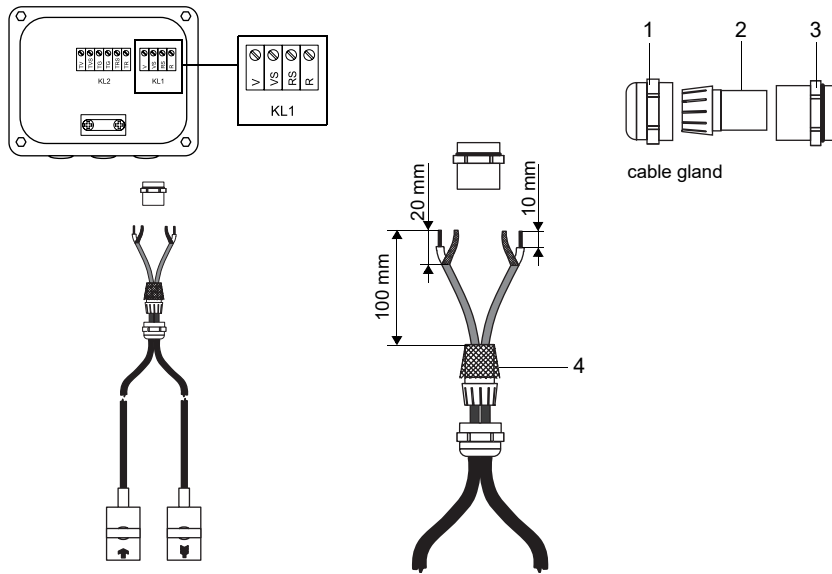
- Remove the blind plug for the connection of the transducer cable.
- Insert the transducer cable into the junction box.
- Fix the transducer cable by tightening the cable gland.
- Connect the transducer cable to the terminals of the junction box.

Tab. 7.7: Terminal assignment

terminal	connection
V	transducer (brown cable, marked white)
VS	transducer (red cable)
RS	transducer (red cable)
R	transducer (brown cable)

Fig. 7.8: Connection of the transducer cable with stainless steel conduit and stripped ends

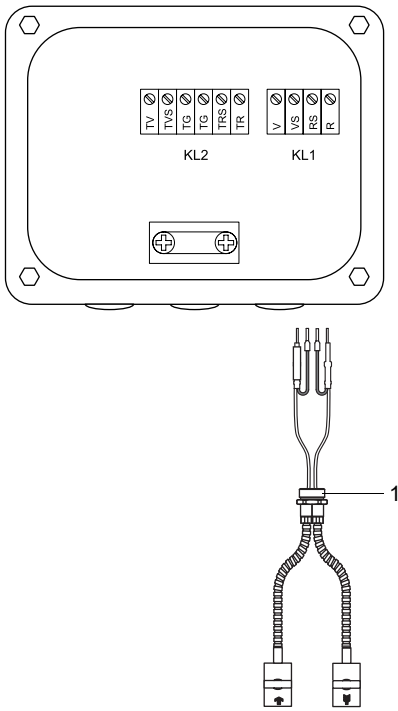

1 – cable gland

7.1.4 Connection of the extension cable to the junction box

7.1.4.1 Connection without potential separation (standard)

The connection of the extension cable to the junction box without potential separation ensures that the transducer, junction box and transmitter are on the same potential. The extension cable should always be connected in this manner, especially if power current cables are nearby. If earthing on the same potential cannot be ensured, see section 7.1.4.2.

- Remove the blind plug for the connection of the extension cable.
- Open the cable gland of the extension cable. The compression part remains in the cap nut.
- Push the extension cable through the cap nut and the compression part.
- Prepare the extension cable.
- Shorten the external shield and brush it back over the compression part.
- Screw the gasket ring side of the basic part into the junction box.
- Insert the extension cable into the junction box.

Notice!

For good electromagnetic compatibility (EMC), it is important to ensure good electrical contact between the external shield and the cap nut (and thus the housing).

- Fix the cable gland by screwing the cap nut onto the basic part.
- Connect the extension cable to the terminals of the junction box.

Tab. 7.8: Terminal assignment

terminal	connection (extension cable)
TV	white or marked cable (core)
TVS	white or marked cable (internal shield)
TRS	brown cable (internal shield)
TR	brown cable (core)
cable gland	external shield

Fig. 7.9: Connection of the extension cable to the junction box (without potential separation)

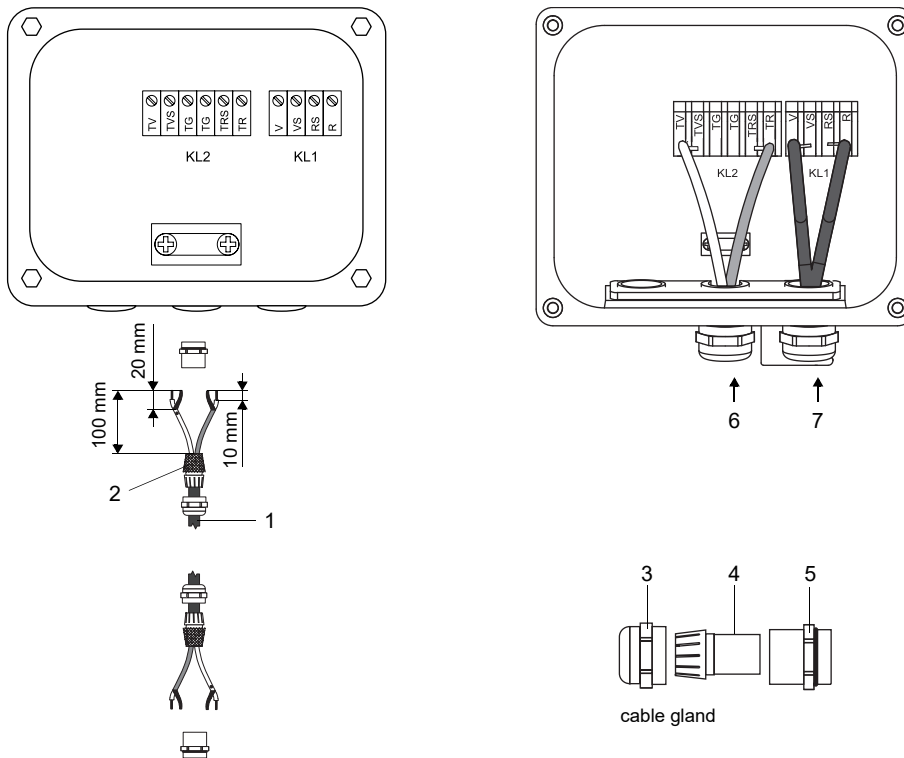

- 1 – extension cable
- 2 – external shield, brushed back
- 3 – cap nut
- 4 – compression part
- 5 – basic part
- 6 – connection of the extension cable
- 7 – connection of the transducer cable

7.1.4.2 Connection with potential separation

If earthing on the same potential cannot be ensured, e.g., in measurement arrangements with long extension cables, the extension cable and the junction box have to be electrically insulated from each other. The junction box and the transducers have to be on the same potential. Thus, no compensation currents can flow to the transmitter via the extension cable.

For measurement arrangements where the junction box and the transducers have to be electrically insulated from each other see the document TIFLUXUS_GalvSep.

- Remove the blind plug for the connection of the extension cable.
- Open the cable gland of the extension cable. The compression part remains in the cap nut.
- Push the extension cable through the cap nut, the compression part and the basic part.
- Insert the extension cable into the junction box.
- Prepare the extension cable.
- Cut the external shield and brush it back.
- Pull the extension cable back until the brushed-back external shield is below the shield terminal. The extension cable has to remain completely insulated up to the shield terminal.
- Screw the gasket ring side of the basic part into the junction box.
- Fix the cable gland by screwing the cap nut onto the basic part.

Important!
 Observe the max. permissible voltage of 60 V DC between the earth potentials.

Important!
 The external shield of the extension cable must not have electrical contact to the junction box. Therefore, the extension cable has to remain completely insulated up to the shield terminal.

- Fix the extension cable and the external shield to the shield terminal.
- Connect the extension cable to the terminals of the junction box.

Tab. 7.9: Terminal assignment

terminal	connection (extension cable)
TV	white or marked cable (core)
TVS	white or marked cable (internal shield)
TRS	brown cable (internal shield)
TR	brown cable (core)
shield terminal	external shield

Fig. 7.10: Connection of the extension cable to the junction box (with potential separation)

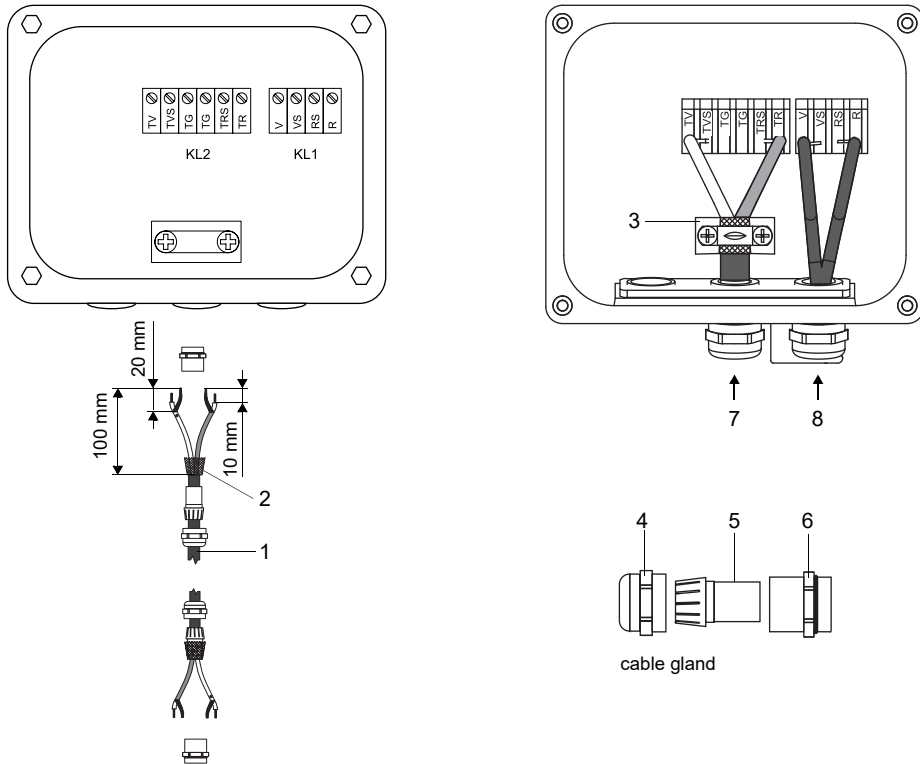

- 1 – extension cable
- 2 – external shield
- 3 – shield terminal
- 4 – cap nut
- 5 – compression part
- 6 – basic part
- 7 – connection of the extension cable
- 8 – connection of the transducer cable

7.1.5 SENSPROM

The SENSPROM contains important transducer data for the operation of the transmitter with the transducers. If transducers are replaced or added, the SENSPROM has to be replaced or added as well.

Notice!

The serial numbers of the SENSPROM and the transducer have to be identical. A wrong or wrongly connected SENSPROM will lead to incorrect measured values or to a measurement failure.

The SENSPROM is connected to the terminals of the transmitter.

- Disconnect the transmitter from the power supply.
- Connect each SENSPROM to the corresponding terminal of the transmitter.
- Connect the transmitter to the power supply.
- Enter all parameters of the menu *Parameters*.
- Start the measurement.

Fig. 7.11: SENSPROM

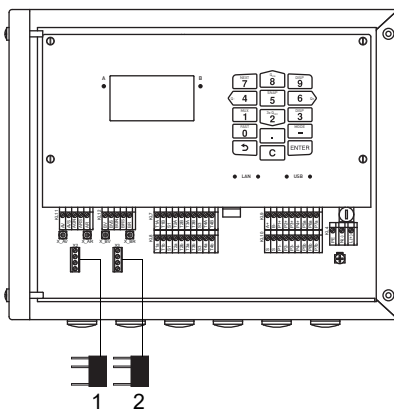

- 1 – SENSPROM A
- 2 – SENSPROM B

7.2 Power supply

The installation of the power supply is carried out by the operator. The operator has to provide an overcurrent protector of max. 16 A (fuse or similar device) disconnecting all energizing wires in case of an inadmissible high current consumption. The impedance of the protective ground has to be low ohmic in order not to allow touch voltage pass the permissible limit. The equipotential bonding terminal serves as functional ground of the transmitter.

Important!

The degree of protection of the transmitter will only be guaranteed if the power cable fits firmly and tightly in the cable gland.

Fig. 7.12: Equipotential bonding terminal on the transmitter

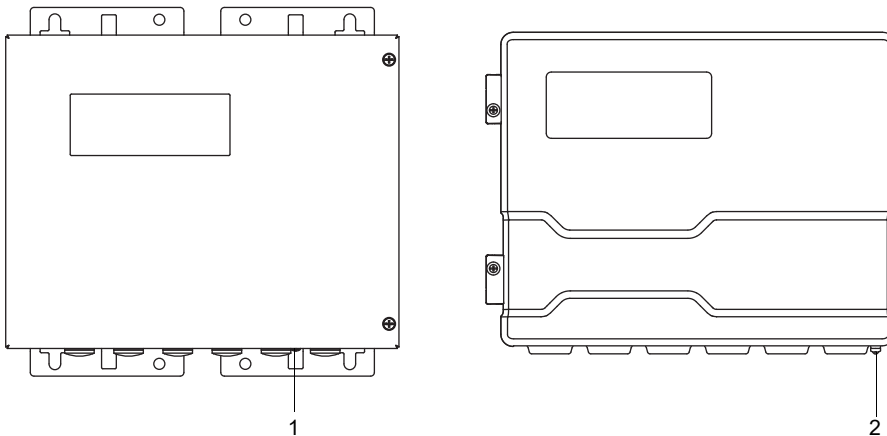

- 1 – equipotential bonding terminal on stainless steel housing
- 2 – equipotential bonding terminal on aluminum housing

• Connect the power cable to the transmitter (see section 7.2.1, Fig. 7.13 and Tab. 7.10).

Fig. 7.13: Connection of the power supply to the transmitter

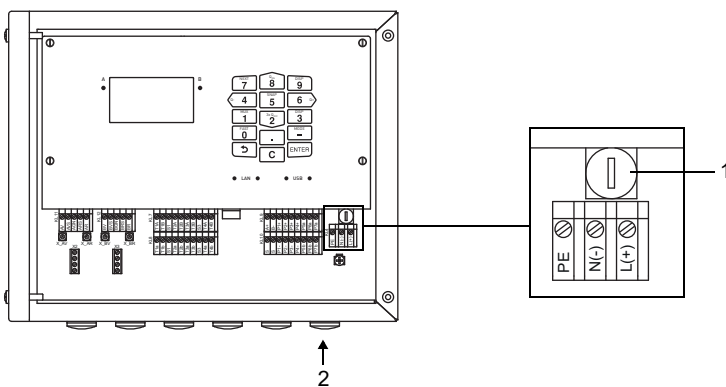

- 1 – fuse
- 2 – connection of the power supply

Tab. 7.10: Terminal assignment

terminal	connection AC	connection DC
L(+)	outer conductor	DC
N(-)	neutral conductor	GND
PE	protective conductor	protective conductor
fuse	1 A, time-lag	1.6 A, time-lag

7.2.1 Cable connection

Transmitter with stainless steel housing

- Remove the blind plug to connect the cable to the transmitter.
- Prepare the cable with a cable gland. The used cable has to have a wire cross-section of 0.25...2.5 mm². The outer diameter of the cable where the ferrite nut is placed may not exceed 7.6 mm.
- Push the cable through the cap nut, compression part, basic part and the sealing ring (sealing ring: only for cable gland M20, not for cable gland 1/2 NPS).
- Insert the cable into the transmitter housing.
- Fix the cable gland by screwing the cap nut onto the basic part.
- Fix the transducer cable by tightening the cable gland with the ferrite nut.
- Connect the cable to the terminals of the transmitter.

Fig. 7.14: Cable gland for stainless steel housing

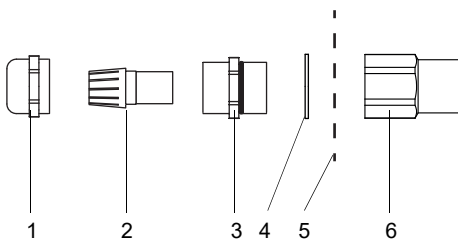

- 1 – cap nut
- 2 – compression part
- 3 – basic part
- 4 – sealing ring (only for cable gland M20, not for cable gland 1/2 NPS)
- 5 – housing wall
- 6 – ferrite nut

Transmitter with aluminum housing

- Remove the blind plug to connect the cable to the transmitter.
- Prepare the cable with a cable gland. The used cable has to have a wire cross-section of 0.25...2.5 mm².
- Push the cable through the cap nut, compression part and basic part of the cable gland.
- Insert the cable into the housing of the transmitter.
- Screw the sealing ring side of the basic part into the transmitter housing.
- Fix the cable gland by screwing the cap nut onto the basic part.
- Connect the cable to the terminals of the transmitter.

Fig. 7.15: Cable gland for aluminum housing

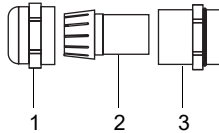

- 1 – cap nut
- 2 – compression part
- 3 – basic part

7.3 Outputs

Important!

The max. permissible voltage between the outputs and against PE is 60 V DC (permanent).

- Connect the output cable to the transmitter (see section 7.2.1, Fig. 7.16 and Tab. 7.11).

Fig. 7.16: Connection of the outputs to the transmitter

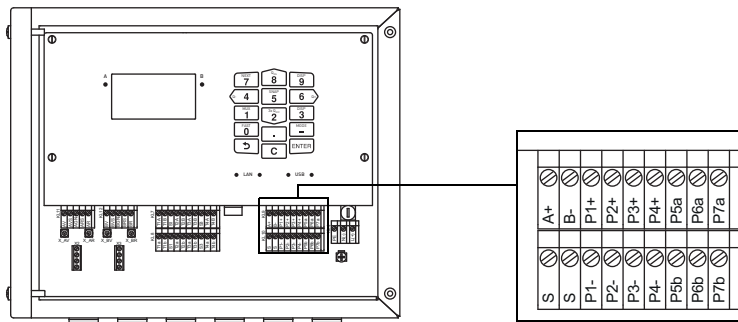

Tab. 7.11: Output circuits

output	transmitter		external circuit	remark
	internal circuit	connection		
active current output/HART	current output			
		Px+ Px-		$U_{int} = 24\text{ V}$ $R_{ext} < 500\ \Omega$
	HART			
		Px+ Px- U_{int}		$U_{int} = 24\text{ V}$ $R_{ext} < 500\ \Omega$
passive current output/HART	current output			
		Px+ Px-		$U_{ext} = 8...30\text{ V}$ $U_{ext} > 0.024\text{ A} \cdot R_{ext} [\Omega] + 8\text{ V}$ example: $U_{ext} = 30\text{ V}$ $R_{ext} \leq 900\ \Omega$
	HART			
		Px+ Px-		$U_{ext} = 10...24\text{ V}$
switchable current output All switchable current outputs are jointly switched to active and passive in the menu Outputs.	active current output			
		Px+ Px-		$U_{int} = 15\text{ V}$ $R_{ext} < 250\ \Omega$
	passive current output			
		Px+ Px-		$U_{ext} = 8...30\text{ V}$ $U_{ext} > 0.024\text{ A} \cdot R_{ext} [\Omega] + 8\text{ V}$ example: $U_{ext} = 30\text{ V}$ $R_{ext} \leq 900\ \Omega$
voltage output		Px+ Px-		$R_{int} = 500\ \Omega$ $R_{ext} > 2\text{ M}\Omega$ If R_{ext} is smaller, the accuracy is less than specified.

The number, type and connections of the outputs depend on the order.

R_{ext} is the sum of all ohmic resistances in the circuit (e.g., resistance of the conductors, resistance of the ammeter/voltmeter).

Tab. 7.11: Output circuits

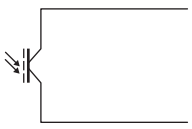
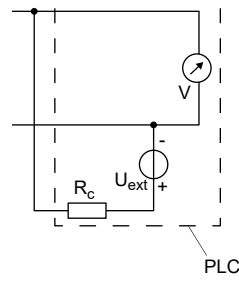
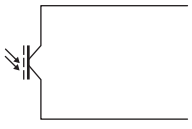
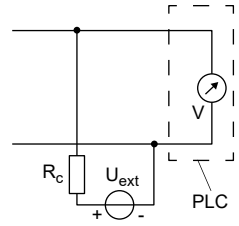
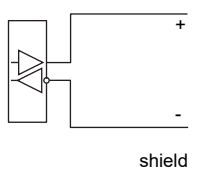
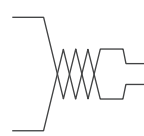
output	transmitter		external circuit	remark
	internal circuit	connection		
digital output	circuit 1			$U_{ext} = 5...30\text{ V}$ $I_c < 100\text{ mA}$ $R_c [\text{k}\Omega] = U_{ext}/I_c [\text{mA}]$
		Pxa Pxb		
digital output	circuit 2			
		Pxa Pxb		
RS485		A+ B- S		120 Ω termination resistor

The number, type and connections of the outputs depend on the order.

R_{ext} is the sum of all ohmic resistances in the circuit (e.g., resistance of the conductors, resistance of the ammeter/voltmeter).

7.4 Inputs

Important!

The max. permissible voltage between the inputs and against PE is 60 V DC (permanent).

Fig. 7.17: Connection of the inputs to the transmitter

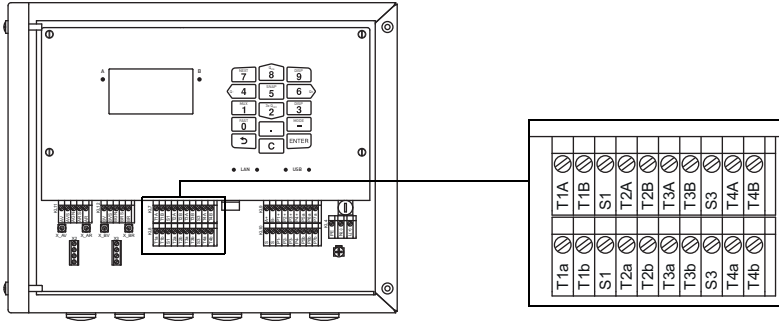

7.4.1 Current input

An active (self-powered) or a passive (external powered) current source can be connected to the current inputs of the transmitter.

Connection of an active current source

Important!

The terminals Txa and Txb must not be connected.

For the connection of the input cable to the transmitter see section 7.2.1, Fig. 7.17 and Tab. 7.12.

Tab. 7.12: Connection of an active current source

input	transmitter		external circuit	remark
	internal circuit	connection		
current input		<p>TxA</p> <p>TxB</p> <p>Txb (not connected)</p>		max. permanent overcurrent: 100 mA

If the polarity of the current source is inversed, only the sign of the measured current will change.

Connection of a passive current sink

Important!
The terminals Txa and TxB must not be connected.

Important!
Observe the correct polarity in order to avoid damaging the current sink. A permanent short circuit can destroy the current input.

For the connection of the input cable to the transmitter see section 7.2.1, Fig. 7.17 and Tab. 7.13.

Tab. 7.13: Connection of a passive current sink

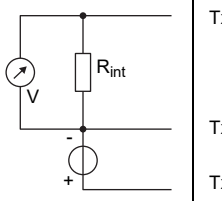
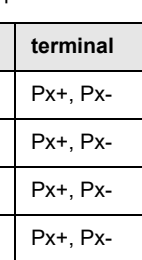
input	transmitter		external circuit	remark
	internal circuit	connection		
current input		TxA TxB (not connected) Txb		max. permanent overcurrent: 100 mA

At full load (20 mA), a voltage of 22.9 V DC is available for the supply of the passive current sink.

7.4.2 Binary input

The transmitter can be equipped with max. 4 binary inputs. Binary inputs can process measured values with short pulse. Via the binary inputs, it is possible to remotely trigger some functions of the transmitter.

For the connection of the input cable to the transmitter, see section 7.2.1, Fig. 7.16 and Tab. 7.14.

Tab. 7.14: Connection of the binary inputs

binary input	terminal
S1	Px+, Px-
S2	Px+, Px-
S3	Px+, Px-
S4	Px+, Px-

7.5 Temperature probe

It is possible to connect the temperature probes Pt100/Pt1000 (4-wire) to the inputs of the transmitter (optional).

Fig. 7.18: Connection of the temperature probes to the transmitter

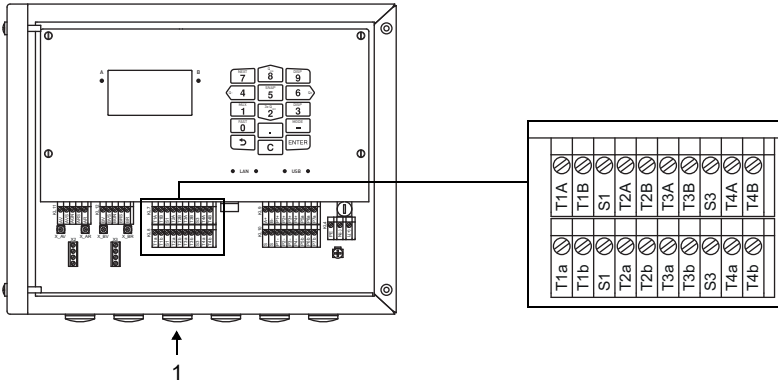

1 – connection of the temperature probe

Tab. 7.15: Connection systems

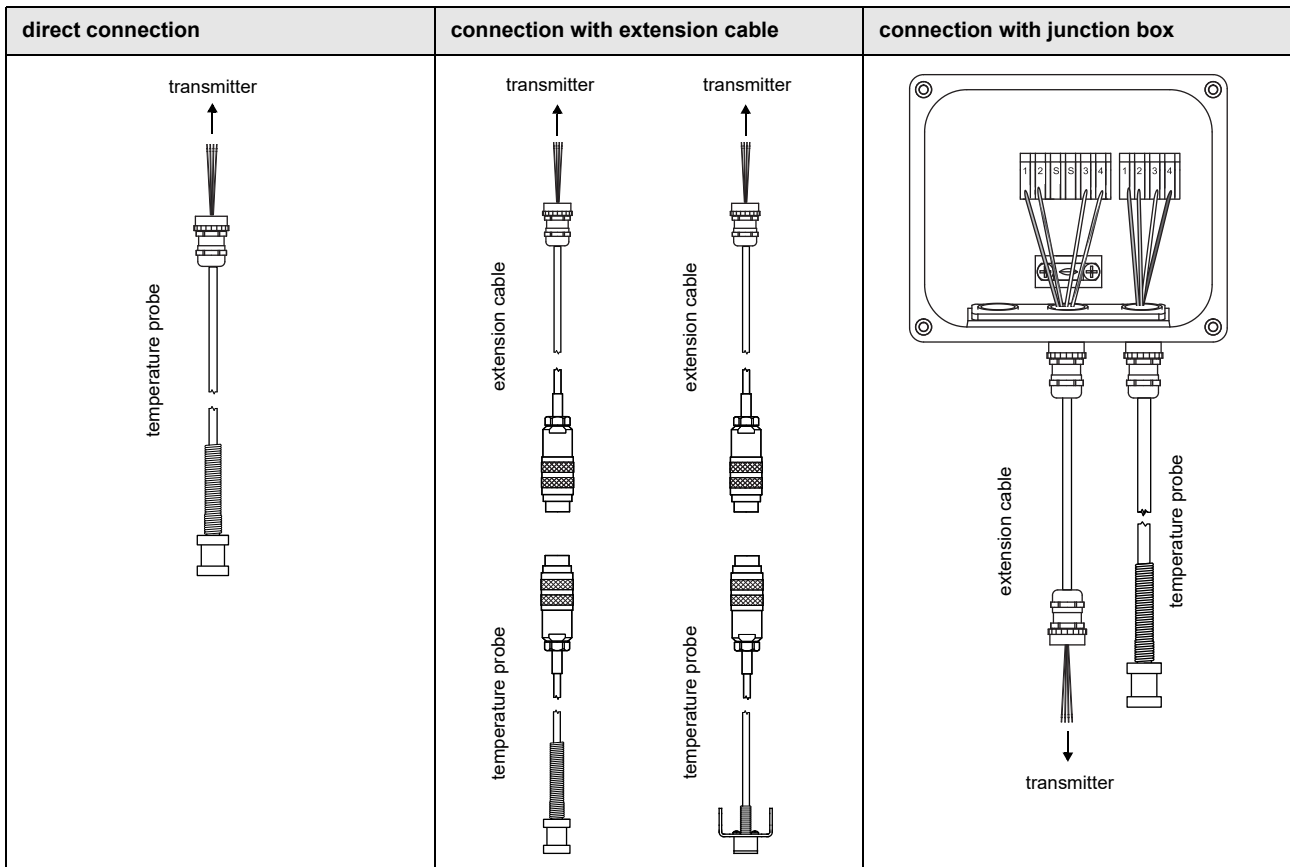

7.5.1 Direct connection of the temperature probe

- Remove the blind plug for the connection of the temperature probe.
- Open the cable gland of the temperature probe. The compression part remains in the cap nut.
- Push the cable of the temperature probe through the cap nut, the compression part, the basic part and the reducer.
- Prepare the cable.
- Shorten the external shield and brush it back over the compression part.
- Insert the cable into the housing.
- Screw the sealing ring side of the reducer into the transmitter housing.
- Screw the basic part into the reducer.
- Fix the cable gland by screwing the cap nut onto the basic part.
- Connect the temperature probe to the terminals of the transmitter.

Fig. 7.19: Preparation of the temperature probe

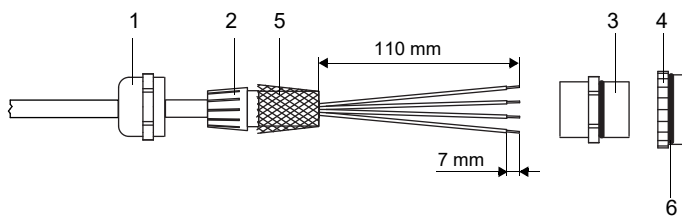

- 1 – cap nut
- 2 – compression part
- 3 – basic part
- 4 – reducer
- 5 – external shield, brushed back
- 6 – sealing ring side

Fig. 7.20: Temperature probe

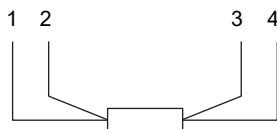

- 1 – red
- 2 – red/blue
- 3 – white/blue
- 4 – white

Tab. 7.16: Terminal assignment (transmitter)

terminal	temperature probe
T1a...T4a	red
T1A...T4A	red/blue
T1b...T4b	white/blue
T1B...T4B	white

7.5.2 Connection with extension cable

- Remove the blind plug for the connection of the temperature probe.
- Open the cable gland of the extension cable. The compression part remains in the cap nut.
- Push the extension cable through the cap nut, the compression part, the basic part and the reducer.
- Prepare the extension cable.
- Cut the external shield to length and brush it back over the compression part.
- Insert the extension cable into the housing.
- Screw the sealing ring side of the reducer into the transmitter housing.
- Screw the basic part into the reducer.
- Fix the cable gland by screwing the cap nut onto the basic part.
- Connect the connectors of the extension cable and the temperature probe.
- Connect the extension cable to the terminals of the transmitter.

Tab. 7.17: Terminal assignment (transmitter)

terminal	extension cable
T1a...T4a	red
T1A...T4A	gray
T1b...T4b	blue
T1B...T4B	white

7.5.3 Connection with junction box

Connection of the extension cable to the transmitter

- Remove the blind plug for the connection of the temperature probe.
- Open the cable gland of the extension cable. The compression part remains in the cap nut.
- Push the extension cable through the cap nut, the compression part, the basic part and the reducer.
- Prepare the extension cable.
- Cut the external shield to length and brush it back over the compression part.
- Insert the extension cable into the housing.
- Screw the sealing ring side of the reducer into the transmitter housing.
- Screw the basic part into the reducer.
- Fix the cable gland by screwing the cap nut onto the basic part.
- Connect the extension cable to the terminals of the transmitter.

Connection of the extension cable to the junction box

- Remove the blind plug for the connection of the extension cable.
- Open the cable gland of the extension cable. The compression part remains in the cap nut.
- Push the extension cable through the cap nut and the compression part.
- Prepare the extension cable.
- Cut the external shield to length and brush it back over the compression part.
- Screw the sealing ring side of the reducer into the junction box.
- Screw the basic part into the reducer.
- Insert the extension cable into the junction box.
- Fix the cable gland by screwing the cap nut onto the basic part.
- Connect the extension cable to the terminals of the junction box.

Fig. 7.21: Preparation of the extension cable

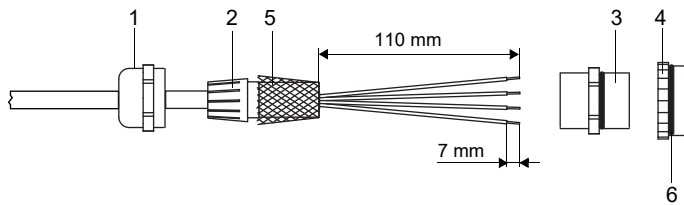

- 1 – cap nut
- 2 – compression part
- 3 – basic part
- 4 – reducer
- 5 – external shield, brushed back
- 6 – sealing ring side

Fig. 7.22: Junction box

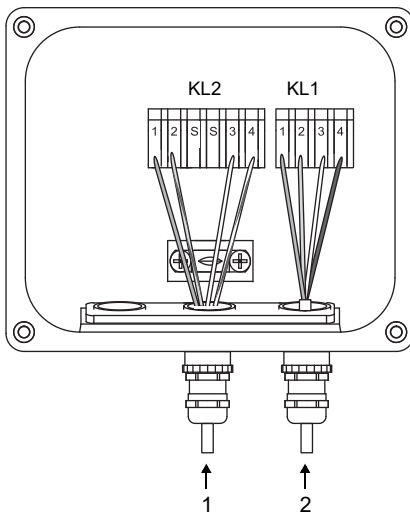

- 1 – connection of the extension cable
- 2 – connection of the temperature probe

Connection of the temperature probe to the junction box

- Remove the blind plug for the connection of the temperature probe.
- Open the cable gland of the temperature probe. The compression part remains in the cap nut.
- Push the cable of the temperature probe through the cap nut and the compression part.
- Prepare the cable.
- Cut the external shield to length and brush it back over the compression part.
- Screw the sealing ring side of the reducer into the junction box.
- Screw the basic part into the reducer.
- Insert the cable into the junction box.
- Fix the cable gland by screwing the cap nut onto the basic part.
- Connect the temperature probe to the terminals of the junction box.

Tab. 7.18: Terminal assignment (junction box)

terminal	extension cable (KL2)	temperature probe (KL1)
1	red	red
2	gray	red/blue
3	blue	white/blue
4	white	white

7.6 Service interfaces

7.6.1 USB interface

The transmitter can be connected directly to the PC via the USB interface.

- Connect the USB cable to the USB interface of the transmitter and to the PC.

Fig. 7.23: Connection of the USB cable

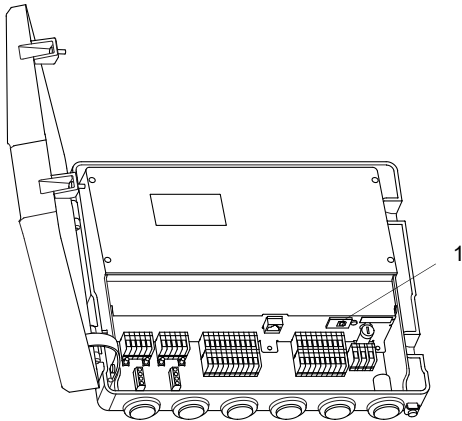

1 – USB interface

7.6.2 LAN interface

The transmitter can be connected to the PC or LAN via a LAN cable.

Transmitter with stainless steel housing

Fig. 7.24: Connection of the LAN cable

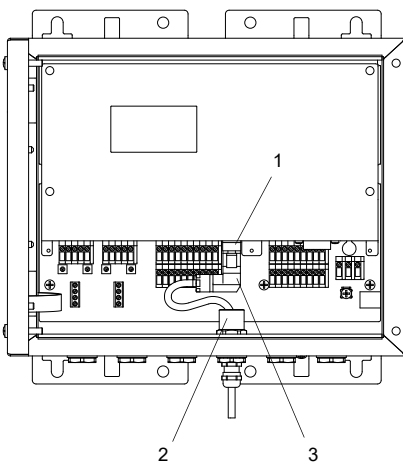

1 – LAN interface
2 – ferrite nut
3 – LAN connector

- Remove the blind plug to connect the cable to the transmitter.
- Open the cable gland of the LAN cable. The compression part remains in the cap nut.

Fig. 7.25: Cable gland

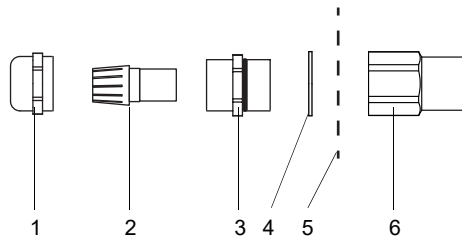

- 1 – cap nut
- 2 – compression part
- 3 – basic part
- 4 – sealing ring (only for cable gland M20, not for cable gland 1/2 NPS)
- 5 – housing wall
- 6 – ferrite nut

- Push the cable through cap nut, compression part, basic part and sealing ring (sealing ring: only for cable gland M20, not for cable gland 1/2 NPS).
- Insert the cable into the housing of the transmitter.
- Push the cable through the ferrite nut.
- Prepare the cable (see the documentation provided by the manufacturer).
- Install the connector (see the documentation provided by the manufacturer).
- Insert the connector into the LAN interface.
- Position the cable in the housing as shown in Fig. 7.24.
- Fix the cable gland by screwing the cap nut onto the basic part.
- Fix the transducer cable by tightening the cable gland with the ferrite nut.

Transmitter with aluminum housing

Fig. 7.26: Connection of the LAN cable

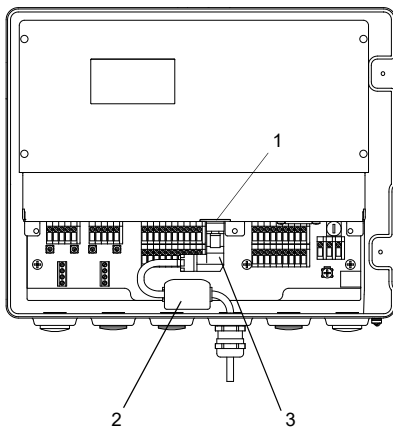

- 1 – LAN interface
- 2 – foldable ferrite core
- 3 – LAN connector

- Remove the blind plug to connect the cable to the transmitter.
- Open the cable gland of the LAN cable. The compression part remains in the cap nut.

Fig. 7.27: Cable gland

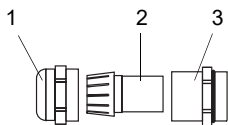

- 1 – cap nut
- 2 – compression part
- 3 – basic part

- Push the cable through the cap nut, compression part and basic part of the cable gland.
- Insert the cable into the housing of the transmitter.
- Prepare the cable (see the documentation provided by the manufacturer).
- Install the connector (see the documentation provided by the manufacturer).
- Insert the connector into the LAN interface.
- Fix the foldable ferrite core to the cable.
- Position the cable in the housing as shown in Fig. 7.26.
- Screw the sealing ring side of the basic part into the transmitter housing.
- Fix the cable gland by screwing the cap nut onto the basic part.

8 Start-up

Danger!



Risk of explosion when using the measuring equipment in explosive atmospheres

This may result in personal or material damage or dangerous situations.

→ Observe the "Safety instructions for the use in explosive atmospheres".

Warning!



Installation, connection and start-up by unauthorized and unqualified personnel

This may result in personal or material damage or dangerous situations.

→ Any work on the transmitter has to be carried out by authorized and qualified personnel.

Danger!



Working in mines or cramped confines

Risk of intoxication and/or asphyxiation because of emerging gases, risk of injuries because of cramped conditions.

→ Wear the required personal protective equipment.

→ Observe the applicable rules.

Caution!



Safety and accident prevention regulations for electrical systems and equipment

Failure to observe these regulations may lead to severe injuries.

→ Observe the safety and accident prevention regulations for electrical systems and equipment.

Caution!



Warning of severe injuries from hot or cold components

Touching hot or cold components can lead to severe injuries (e.g., thermal damage).

→ Any mounting, installation or connection work has to be concluded.

→ Any work on the measuring point during the measurement is prohibited.

→ Observe the ambient conditions at the measuring point during installation.

→ Wear the required personal protective equipment.

→ Observe the applicable rules.

Notice!

The transmitter and transducers have to be checked to ensure proper condition and operational safety before each use. The transmitter housing must always be closed during operation. Observe that maintenance work must be concluded.

8.1 Start-up settings

When starting up the transmitter for the first time, the following settings are required:

- language
- time/date
- system of units

These displays will only be indicated when the transmitter is switched on for the first time or after an initialization.

Language

The available transmitter languages are displayed.

- Select a language.
- Press ENTER.

The menus are displayed in the selected language.

Set time

The current time is displayed.

- Press ENTER to confirm the time or set the current time via the numeric field.
- Press ENTER.

Set date

The current date is displayed.

- Press ENTER to confirm the date or set the current date via the numeric field.
- Press ENTER.

Units of measurement

- Select `Metric` or `Imperial`.
- Press ENTER.

Region of Canada

- Select `Yes` if the transmitter is to be used in the region of Canada.
- Press ENTER.

This display will only be indicated if `Imperial` is selected.

8.2 Switching on

As soon as the transmitter is connected to the power supply, the menu is displayed in the adjusted language. The language can be changed.

Notice!

The parameters cannot be changed during the measurement. The measurement has to be stopped in order to change the parameters.

If the transmitter was switched off during the measurement, the message `Measurement started` will be displayed after connecting the transmitter to the power supply. The measurement continues with the parameters set last.

By pressing  it is possible either to stop the measurement or to display the current parameter settings.

8.3 Status indications

The operation state is indicated by LEDs.

Fig. 8.1: Command panel of the transmitter

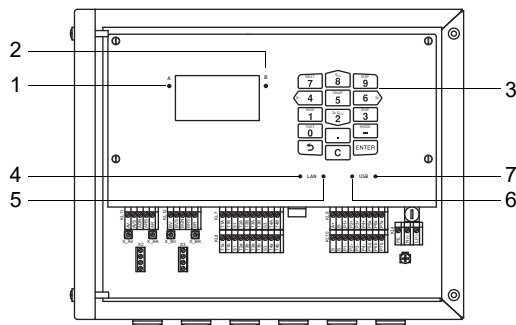

- 1 – LED (channel A)
- 2 – LED (channel B)
- 3 – keyboard
- 4 – LED LAN activity
- 5 – LED LAN mode
- 6 – LED USB device
- 7 – LED USB host (not used)

Tab. 8.1: Operation state of the transmitter

LED (channel A)	Lights if the transmitter is in measuring mode and channel A is activated. red – invalid measurement green – valid measurement
LED (channel B)	Lights if the transmitter is in measuring mode and channel B is activated. red – invalid measurement green – valid measurement
LED LAN activity	Lights if the transmitter is connected to a network via USB cable. Flashes in case of data exchange on the network connection.
LED LAN mode	Lights if the data rate is 100 MBit/s otherwise it is 10 MBit/s.
LED USB device	Lights if the transmitter is connected to a PC via USB cable. Flashes in case of data exchange between PC and transmitter.

8.4 Language

```
Miscellaneous\System settings\Language
```

The language of the transmitter can be selected:

- Select the menu item `Language`.
- Press `ENTER`.
- Select the desired language from the scroll list.
- Press `ENTER`.



Afterwards the menu will be displayed in the selected language. The selected language remains activated when the transmitter is switched off and on again.

The language can also be changed by entering a HotCode.

8.5 Initialization

During an initialization (INIT) of the transmitter, all settings are reset to the factory settings.

Proceed as follows to execute an initialization:

- When switching on a transmitter: keep  and C pressed.
- During the operation of the transmitter: press , C and ENTER simultaneously. Release only ENTER. Keep  and C pressed.

During an initialization it is tested whether the key lock is activated. If so, it has to be deactivated.

- Enter a 6-digit key lock code.
- Press ENTER.

If a measurement is currently running, it will be stopped.

It will be requested whether the initial settings are to be carried out.

Initial settings

If Yes is selected, the following setting dialogs will be displayed.

- Language
- Date/time
- Units of measurement
- Delete meas. values
- Delete snaps
- Delete user subst. (all customized materials and fluids which were stored after delivery will be deleted)
- Reset totalizers

The initialization can also be started with the HotCode **909000**.

8.6 Date and time

Miscellaneous\System settings\Date/time

The transmitter has a battery-powered clock. Measured values are automatically stored with date and time.

- Select the menu item Date/time.

The adjusted time is displayed.

- Enter the current time.
- Press ENTER.

The adjusted date is displayed.

- Enter the current date.
- Press ENTER.

8.7 Information regarding the transmitter

Miscellaneous\System settings\Transmitter info

- Select the menu item `Transmitter info`.
- Press `ENTER`.
- Press `2` or `8` to scroll through the list.
- Press `↩` to return to the menu item `System settings`.

The following information relating to the transmitter is displayed:

display	description
Serial number	serial number of the transmitter
Firmware version	version number of the installed firmware
Firmware date	creation date of the installed firmware
Production date	manufacturing date of the transmitter
Verification log	state of the verification logger

9 Measurement

Danger!



Risk of explosion when using the measuring equipment in explosive atmospheres

This may result in personal or material damage or dangerous situations.

→ Observe the "Safety instructions for the use in explosive atmospheres".

Caution!



Warning of severe injuries from hot or cold components

Touching hot or cold components can lead to severe injuries (e.g., thermal damage).

→ Any mounting, installation or connection work has to be concluded.

→ Any work on the measuring point during the measurement is prohibited.

→ Observe the ambient conditions at the measuring point during installation.

→ Wear the required personal protective equipment.

→ Observe the applicable rules.

9.1 Parameter input

Notice!

Avoid a simultaneous parameter entry via the keyboard and the USB, LAN or process interface. The parameter records received via these interfaces will overwrite the current transmitter parametrization.

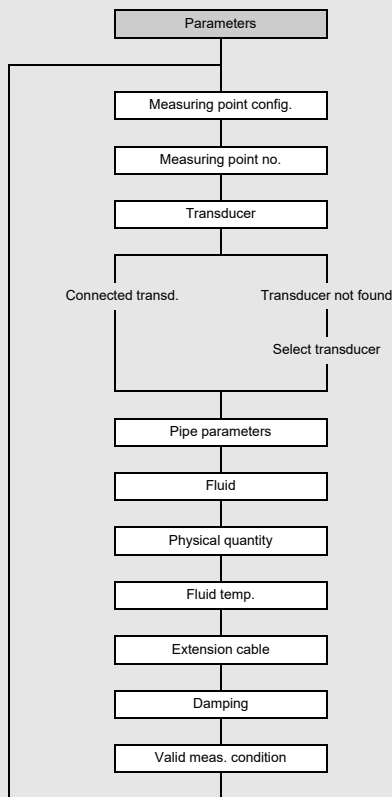

see annex A

The pipe and fluid parameters are entered for the selected measuring point. The parameter ranges are limited by the technical characteristics of the transducers and the transmitter.

- Select the menu `Parameters`.
- Press `ENTER`.

9.1.1 Measuring point configuration

```
Parameters\Measuring point config.\1 meas. point (AB)
```

- Select the configuration of the measuring point (here: 1 meas. point (AB)).
- Press ENTER.

The display will not be indicated if the transmitter has only one measuring channel.

Tab. 9.1: Measuring point configuration

1 meas. point (A)	1 meas. point (AB)	2 meas. points (A B)
The measurement is carried out using 1 measuring channel at 1 measuring point.	The measurement is carried out using 2 measuring channels at 1 measuring point.	The measurement is carried out using 2 measuring channels at 2 measuring points.

If 2 meas. points (A|B) is selected for the configuration of the measuring point, the parameters have to be entered for each measuring point.

```
Parameters\Measuring point config.\2 meas. points (A|B)\Select meas. point\A:
```

- Select a measuring point.
- Press ENTER.

FLUXUS *722:

If the synchronized channel averaging is activated in the menu item `Miscellaneous\Measurement\Measurement modes\Synch. chan. averag., 1 meas. point (AB)` has to be selected for the configuration of the measuring point.

9.1.2 Input of the measuring point number

```
Parameters\Measuring point no.
```

- Enter the number of the measuring point.
- Press ENTER.

For the activation of text input see `Miscellaneous\Dialogs/Menus\Measuring point no.`

9.1.3 Transducer selection

Notice!

The transducers have to be selected depending on the application parameters (see technical specification).

```
Parameters\Connected transd.
```

- The transducer connected to the transmitter is displayed.
- Press ENTER.

The display will only be indicated if a SENSPROM is connected to the transmitter.

The display `Transducer not found` will be indicated if neither transducers nor SENSPROM are connected.

- Press ENTER.

```
Parameters\Select transducer
```

The following display appears: `Select transducer`. Standard sensors that are stored in the transmitter can be selected.

- Select the transducer.
- Press ENTER.

Notice!

If a standard transducer is selected, no transducer-specific calibration values are considered. A higher uncertainty has to be expected.

9.1.4 Input of pipe parameters

Outer pipe diameter

Parameters\Outer diameter

- Enter the outer pipe diameter.
- Press ENTER.

It is possible to enter the pipe circumference instead of the outer pipe diameter.

Pipe circumference

Parameters\Pipe circumference

- The input of the pipe circumference can be activated in the menu item `Miscellaneous\Dialogs/Menus\Pipe circumference`.
- Press in the menu item `Outer diameter`. The menu item `Pipe circumference` will be displayed.
- Enter the pipe circumference.
- Press ENTER.

If the outer pipe diameter is to be entered, press . The menu item `Outer diameter` will be displayed.

Pipe material

Parameters\Pipe material

The pipe material has to be selected to be able to determine the corresponding sound speed.
The sound speeds for the materials in the scroll list are stored in the transmitter.

- Select the pipe material.
- If the material is not in the scroll list, select the list item `Other material`.
- Press ENTER.

Sound speed of the pipe material

Parameters\Pipe material\Other material\c material

- Enter the sound speed of the pipe material.

Notice!

There are 2 sound speeds for pipe materials: the longitudinal and the transversal one. Enter the sound speed which is nearer to 2500 m/s.

- Press ENTER.
- Select `Transverse wave` or `Longitudinal wave`.
- Press ENTER.

These displays will only be indicated if `Other material` is selected.

For the sound speed of some materials see annex C.

Roughness of the pipe material

Parameters\Pipe material\Other material\Roughness

The flow profile of the fluid is influenced by the roughness of the inner pipe wall.

The roughness is used for the calculation of the profile correction factor.

In most cases, the pipe roughness cannot be exactly determined and must therefore be estimated.

- Press ENTER if the pipe has a lining. The roughness of the lining is included into the calculation.
- Enter the roughness of the pipe material in case the pipe has no lining. Press ENTER.

This display will only be indicated if `Other material` is selected.

For the roughness of some materials see annex C.

Wall thickness

Parameters\Pipe wall thickness

- Enter the pipe wall thickness.
- Press ENTER.

Lining

Parameters\Lining

- Select `Yes` if the pipe has a lining. Select `No` if the pipe has no lining.
- Press ENTER.

Lining material

Parameters\Lining material

- Select the lining material.
- Press ENTER.
- If the lining material is not included in the scroll list, select the list item `Other material`.
- Press ENTER.

This display will only be indicated if `Yes` is selected in the menu item `Lining`.

Sound speed of the lining material

Parameters\Lining material\Other material\c material

- Enter the sound speed of the lining material.

Notice!

For pipe materials there are 2 sound speeds, the longitudinal and the transversal one. Enter the sound speed which is nearer to 2500 m/s.

- Press ENTER.
- Select `Transverse wave` or `Longitudinal wave`.
- Press ENTER.

These displays will only be indicated if `Other material` is selected.

Roughness of the lining material

Parameters\Lining material\Other material\Roughness

The flow profile of the fluid is influenced by the roughness of the inner pipe wall.
The roughness is used for the calculation of the profile correction factor.
In most cases, the pipe roughness cannot be exactly determined and must therefore be estimated.

- Enter the roughness of the lining material.
- Press ENTER.

This display will only be indicated if `Other material` is selected.

Lining thickness

Parameters\Lining thickness

- Enter the thickness of the lining.
- Press ENTER.

This display will only be indicated if `Yes` is selected in the menu item `Lining`.

Roughness

Parameters\Roughness

The flow profile of the fluid is influenced by the roughness of the inner pipe wall.
The roughness is used for the calculation of the profile correction factor.
In most cases, the pipe roughness cannot be exactly determined and must therefore be estimated.

- If `Automatic` is selected, the roughness values stored in the transmitter are used.
- If `Customized` is selected, a roughness value has to be entered.
- Press ENTER.

This display will not be indicated if `Other material` is selected in the menu item `Pipe material` or `Lining material`.

9.1.5 Input of fluid parameters

Fluid

Parameters\Fluid

- Select the fluid from the scroll list.
- If the fluid is not in the scroll list, select the list item `Other fluid`.
- Press ENTER.

Sound speed of the fluid

Parameters\Fluid\Other fluid\c fluid

The sound speed of the fluid is used for the calculation of the transducer distance. The exact value of the sound speed is not always known. Therefore, a range of possible values for the sound speed has to be entered.

- Enter the average sound speed of the fluid.
- Press ENTER.

This display will only be indicated if `Other fluid` is selected.

Sound speed range of the fluid

Parameters\Fluid\Other fluid\Range c fluid

- Select `Automatic` if the range around the average sound speed has to be set to $\pm 10\%$ the entered sound speed.
- Select `Customized` if the range around the average sound speed has to be entered.
- Press ENTER.

This display will only be indicated if `Other fluid` is selected.

Parameters\Fluid\Other fluid\Range c fluid\Customized

- Enter the range around the average sound speed of the fluid.
- Press ENTER.

This display will only be indicated if `Customized` is selected.

Kinematic viscosity of the fluid

Parameters\Fluid\Other fluid\Kin. viscosity

The kinematic viscosity influences the flow profile of the fluid. The value is considered in the profile correction.

- Enter the kinematic viscosity of the fluid.
- Press ENTER.

This display will only be indicated if `Other fluid` is selected.

Fluid density

Parameters\Fluid\Other fluid\Fluid density

The density is used to calculate the mass flow.

If the mass flow is not measured, an input is unnecessary. The default value can be used.

- Enter the operating density of the fluid.
- Press ENTER.

This display will only be indicated if `Other fluid` is selected.

9.1.6 Measurement settings**Selection of the physical quantity**

Parameters\Physical quantity

The available physical quantities are displayed in a list.

- Select the physical quantity.
- Press ENTER.

Selection of the unit of measurement

Parameters\Physical quantity\Flow velocity

For the selected physical quantity (except sound speed), a scroll list with the available units of measurement is displayed.

- Select the unit of measurement of the physical quantity.
- Press ENTER.

Notice!

If the physical quantity or the unit of measurement is changed, the settings of the outputs have to be checked.

9.1.7 Further parameters

Fluid temperature

```
Parameters\Fluid temp.
```

The fluid temperature is used:

- at the beginning of the measurement for the interpolation of the sound speed and therefore for the calculation of the recommended transducer distance
- during the measurement for the interpolation of the density and the viscosity of the fluid

This value is only used, if the fluid temperature is not measured. The value has to be within the ambient temperature of the transducers.

- Enter the fluid temperature. In case of a temperature range, enter the average fluid temperature.

Notice!

If the relation between the sound speed and the temperature is not linear, see the sound speed-temperature curve.

- Press ENTER.

Parametrization of a mixture with changing composition

If a mixture with changing composition has been selected, the variable proportion of the mixture has to be entered (see annex C.3.2).

- Enter the variable proportion of the mixture.
- Press ENTER.

Extension cable

```
Parameters\Extension cable
```

In case the transducer cable is extended (e.g., between junction box and transmitter), enter the length of the extension cable.

- Enter the length of the extension cable.
- Press ENTER.

Input of the damping factor

```
Parameters\Damping
```

Each displayed measured value is a floating average of the last x seconds, with x being the damping factor. If 0 s is entered as damping factor, no average is calculated.

The value of 10 s is appropriate for normal flow conditions. If the values fluctuate strongly, caused by a higher dynamic flow, a higher damping factor can be very useful.

- Enter the damping factor.
- Press ENTER.

Dynamic damping

If dynamic damping is activated, volatile changes in the measured values of the selected physical quantity are transmitted through the transmitter without any time lag.

Important!

The dynamic damping will only have impact on the selected physical quantity. All other physical quantities are not dynamically damped.

Parameters\Dynamic damping

- Select **On** to activate the dynamic damping.
- Press **ENTER**.

This display will only be indicated if dynamic damping has been activated in the menu item `Miscellaneous\Measurement\Measurement settings\Dynamic damping`.

Parameters\...\Dynamic threshold

- Enter the value for the dynamic threshold. If zero is entered, dynamic damping will be deactivated.
- Press **ENTER**.

Parameters\...\Transient damping

- Enter the damping factor for the temporary damping.
- Press **ENTER**.

Notice!

If another physical quantity is selected, the dynamic damping has to be entered again.

Input of the error delay

Parameters>Error delay

The error delay is the time interval after which the error value is transmitted to the output.

This display will only be indicated if the list item `Edit` is selected in the menu item `Miscellaneous\Dialogs/Menu/Error delay`.

If no error delay is entered, the damping factor will be used.

- Enter a value for the error delay.
- Press **ENTER**.

Definition of conditions for valid measurements

Parameters\Valid meas. condition

- Select a condition.
- Press ENTER.

This display will only be indicated if the list item 1 meas. point (AB) is selected in the menu item Parameters\Measuring point config.

Tab. 9.2: Condition for a valid measurements

all channels OK	1 channel OK
mean with "AND" All measuring channels have to deliver a valid measuring value.	mean with "OR" At least one measuring channel has to deliver a valid measuring value.

9.2 Configuration of an output

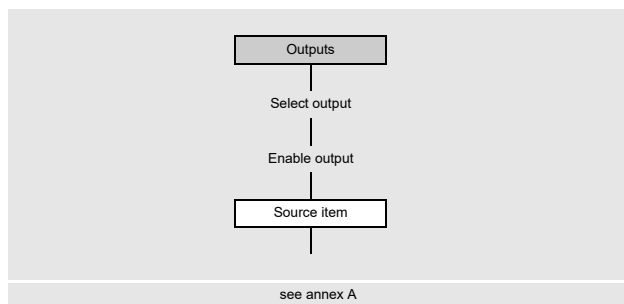

If the transmitter is equipped with outputs, they have to be configured. The measured value, the status value or an event value can be transmitted via the different outputs. In the following the configuration of the current output is described.

- Select the menu `Outputs`.
- Press ENTER.

The scroll list contains all available outputs of the transmitter.

Outputs\Current I1(-)

- Select an output (here: `Current I1 (-)`).
- Press ENTER.

If the output has already been enabled, it is displayed as follows: `I1 (✓)`.

Outputs\Current I1\I1 Enable

- Select `Yes` to change the settings for an already enabled output.
- Select `No` to cancel the assignment and to return to the previous menu item.
- Press ENTER.

If the list item 2 meas. points (A|B) is selected in the menu item Parameters\Measuring point config., the measuring point must be selected for which the measured values are to be transmitted to the output.

- Select a list item.
- Press ENTER.

Assignment of a source item

A source item has to be assigned to each selected output.

Outputs\...\Source item

- Select a source item whose measured value, status value or event value is to be transmitted to the output.
- Press ENTER.

Tab. 9.3: Configuration of the outputs

source item	list item	output
Flow quantities	Flow velocity Volumetric flow rate Mass flow rate Thermal energy rate ⁽¹⁾	flow velocity volumetric flow rate mass flow rate thermal energy rate
Totalizers	Volume (+) Volume (-) Volume (Δ) Mass (+) Mass (-) Mass (Δ) Thermal energy (+) ⁽¹⁾ Thermal energy (-) ⁽¹⁾ Thermal energy (Δ) ⁽¹⁾	totalizer for the volumetric flow rate in positive flow direction totalizer for the volumetric flow rate in negative flow direction difference of the totalizers for the positive and negative flow direction totalizer for the mass flow rate in positive flow direction totalizer for the mass flow rate in negative flow direction difference of the totalizers for the positive and negative flow direction thermal energy totalizer for positive measured values of the thermal energy rate thermal energy totalizer for negative measured values of the thermal energy rate difference of the thermal energy totalizer
Fluid properties	Fluid temp. Supply temperature ⁽¹⁾ Return temperature ⁽¹⁾ Temperature (Δ) ⁽¹⁾ Fluid pressure Supply pressure ⁽¹⁾ Return pressure ⁽¹⁾ Pressure (Δ) ⁽¹⁾ Fluid density Kin. viscosity Dyn. viscosity	fluid temperature supply temperature (thermal energy rate measurement) return temperature (thermal energy rate measurement) difference between supply and return temperature (thermal energy rate measurement) fluid pressure supply pressure (thermal energy rate measurement) return pressure (thermal energy rate measurement) difference between supply and return pressure (thermal energy rate measurement) fluid density kinematic viscosity dynamic viscosity
Event trigger	R1 R2 R3 R4	limit message (Event trigger R1) limit message (Event trigger R2) limit message (Event trigger R3) limit message (Event trigger R4)

⁽¹⁾ only if Thermal energy rate is selected as physical quantity in the menu Parameters

Tab. 9.3: Configuration of the outputs

source item	list item	output
Diagnostic values	Amplitude	signal amplitude
	Quality	signal quality
	SNR	signal-to-noise ratio
	SCNR	signal-to-correlated noise ratio
	VariAmp	amplitude variation
	VariTime	transit time variation
	Gain	gain required to receive a useful signal
	Pig detection	signalizes whether a pig is detected This display will only be indicated if <code>Pig detection</code> is activated.
Miscellaneous	Custom. Input 1	measured values of input quantities (e.g., temperature, density) In the menu item <code>Inputs\Assign inputs</code> it is possible to assign configured inputs to customized inputs.
	Custom. Input 2	
	Custom. Input 3	
	Custom. Input 4	
Sound speed	Sound speed	sound speed
	Sound speed (Δ)	difference of the measured sound speed and the sound speed calculated from the fluid data

⁽¹⁾ only if `Thermal energy rate` is selected as physical quantity in the menu `Parameters`

Depending on the selected source item, it is possible to output measured values, status values or event values.

Tab. 9.4: Output of measured values, status values or event values

	source item	measured value		event value
		value	status	
physical quantities	Flow quantities	x	x	
	Totalizers	x	x	
	Fluid properties	x	x	
	Sound speed	x	x	
	Miscellaneous	x	x	
	Diagnostic values (except <code>Pig detection</code>)	x		
events	Diagnostic values\ <code>Pig detection</code>			x
	Event trigger			x

9.2.1 Output of a measured value

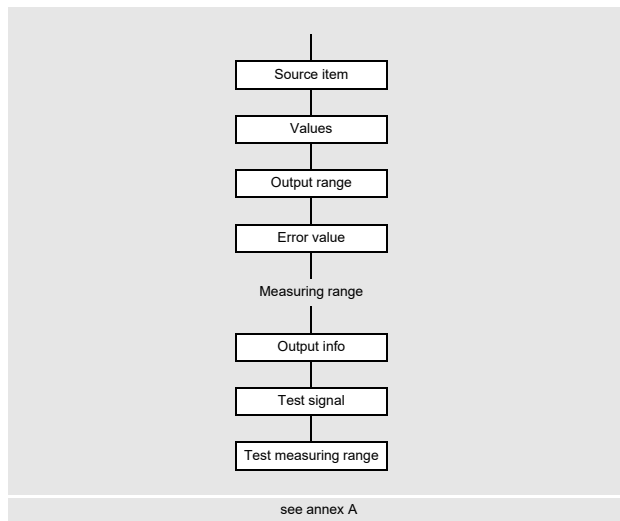

- Select the list item `Outputs\...\Values`.
- Press ENTER.

Output range

`Outputs\...\Output range`

- Select a list item.
 - `4...20 mA`
 - `Other range`
 - Press ENTER.
- If `Other range` is selected, enter the values `Output MIN` and `Output MAX`.

The output range has to be > 10 % of the max. output value (`Output MAX`). If the output range is smaller, an error message will be displayed.

Error output

`Outputs\...\Error value`

An error value can be defined which is output if the source item cannot be measured.

- Select a list item for the error output.
- Press ENTER.
- If `Other value` is selected or the function `NAMUR NE43` is activated, enter an error value. The value has to be outside the output range. If the entered value is not valid, an error message and the permissible range will be displayed.
- Press ENTER.

Example

source item: volumetric flow rate
 output: current output
 output range: 4...20 mA
 error delay: $t_d > 0$

The volumetric flow rate cannot be measured during the time interval $t_0...t_1$. The error value will be output.

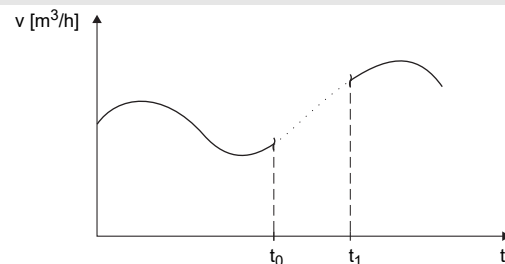

Tab. 9.5: Examples for the error output (output range: 4...20 mA)

list item	output signal
4.0 mA	

Tab. 9.5: Examples for the error output (output range: 4...20 mA)

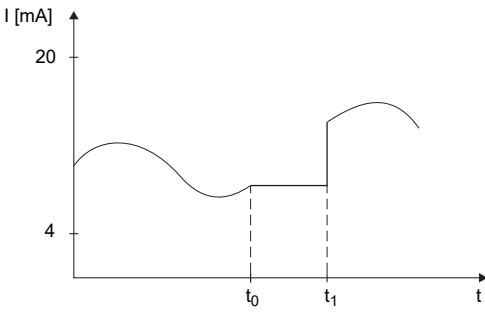
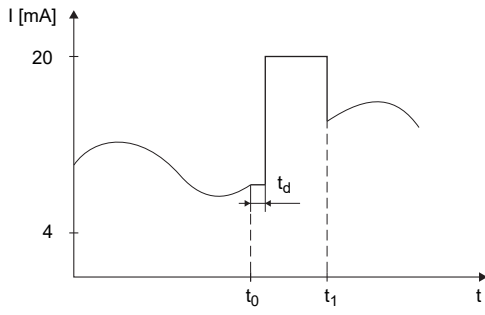
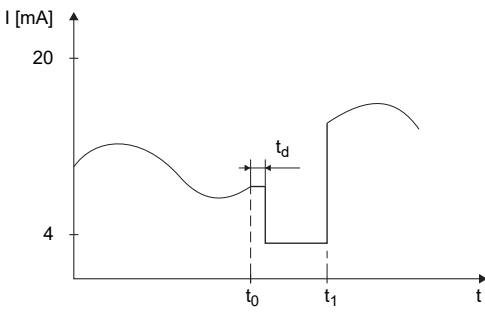
list item	output signal
Last value	
20.0 mA	
Other value error value = 3.5 mA	

Measuring range

The sign of the measured value and the measuring range are determined.

Outputs\...\Measured values\Absolute value

- Select *Sign* if the sign of the measured values is to be considered for the output.
- Select *Absolute value* if the sign of the measured values is not to be considered for the output.

Outputs\...\Start of meas. range

- Enter the lowest expected measured value. The unit of measurement of the source item will be displayed. *Start of meas. range* is the value assigned to the value *Output MIN* of the output range.

Outputs\...\End of meas. range

- Enter the highest expected measured value. The unit of measurement of the source item will be displayed. *End of meas. range* is the value assigned to the value *Output MAX* of the output range.

Terminal assignment

```
Outputs\...\Output info
```

The terminals for the connection of the output are displayed.

By pressing or further information is displayed.

- Press ENTER.

Output function test

The function of the output can now be tested.

- Connect an external measuring instrument to the terminals of the installed output.

```
Outputs\...\Test signal
```

- Select **Yes** to test the output. Select **No** to display the next menu item.
- Press ENTER.

```
Outputs\...\Enter test value
```

- Enter a test value. It has to be within the output range.
- Press ENTER.

If the external measuring instrument displays the entered value, the output functions correctly.

- Select **Repeat** to repeat the test or **Finish** to display the next menu item.
- Press ENTER.

```
Outputs\...\Test measuring range
```

- Select **Yes** to test the assignment of the measured value to the output signal. Select **No** to display the next menu item.
- Press ENTER.

```
Outputs\...\Enter test value
```

- Enter a test value. It has to be within the expected measuring range.
- Press ENTER.

If the external measuring instrument displays the corresponding current value, the output functions correctly.

- Select **Repeat** to repeat the test or **Finish** to display the next menu item.
- Press ENTER.

9.2.2 Output of a status/event value

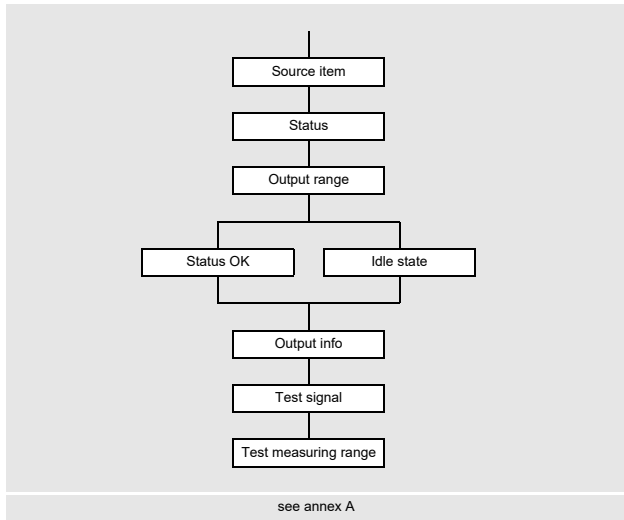

- Select the list item `Outputs\...\Status`.
- Press ENTER.

Output range

```
Outputs\...\Output range
```

- Select a list item.
 - 4...20 mA
 - Other range

- Press ENTER.

If `Other range` is selected, enter the values `Output MIN` and `Output MAX`.

The output range has to be > 10 % of the max. output value (`Output MAX`). If the output range is smaller, an error message will be displayed. The next possible value will be displayed.

status value – status OK	event value – idle state
The status of the output signal is defined which is to be output when measuring a measured value.	The status of the output signal is defined which is to be output if no event occurs.
<ul style="list-style-type: none"> • Select the value for status OK from the scroll list. • Press ENTER. 	<ul style="list-style-type: none"> • Select the value for the idle state. • Press ENTER.

Terminal assignment

```
Outputs\...\Output info
```

The terminals for the connection of the output are displayed.

By pressing `2` or `8` further information is displayed.

- Press ENTER.

Output function test

The function of the output can now be tested.

- Connect an external measuring instrument to the terminals of the installed output.

```
Outputs\...\Test signal
```

- Select `Yes` to test the output. Select `No` to display the next menu item.
- Press ENTER.

```
Outputs\...\Enter test value
```

- Enter a test value. It has to be within the output range.
- Press ENTER.

If the external measuring instrument displays the entered value, the output functions correctly.

- Select **Repeat** to repeat the test or **Finish** to display the next menu item.
- Press **ENTER**.

Outputs\...\Test measuring range

- Select **Yes** to test the status of the output signal. Select **No** to display the next menu item.
- Press **ENTER**.

Outputs\...\Enter test value

- Select a list item as test value.
- Press **ENTER**.

status value	event value
Status OK or Status error If the external measuring instrument displays the value (min. output value for Status error, max. output value for Status OK), the output functions correctly.	Active or Passive If the external measuring instrument displays the value (min. output value for Passive, max. output value for Active), the output functions correctly.

- Select **Repeat** to repeat the test. Select **Finish** to display the next menu item.
- Press **ENTER**.

9.2.3 Operating mode for current outputs

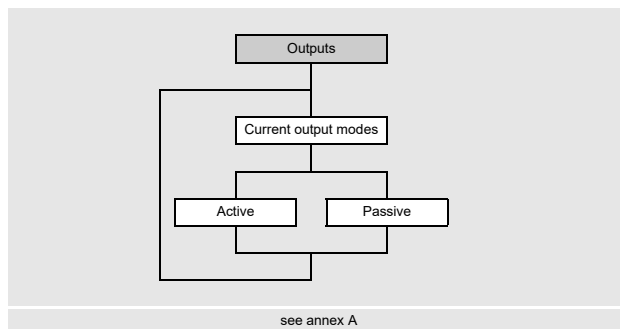

If the transmitter has current outputs that can be operated actively or passively, it must be specified in which operating mode the current outputs are to operate.

- Select the list item **Outputs** in the menu **Current output modes**.
- Press **ENTER**.

Outputs\Current output modes

- Select **Active** or **Passive** to operate the current outputs in the corresponding mode.
- Press **ENTER**.

The selected setting always applies to all available current outputs.

9.3 Start of measurement

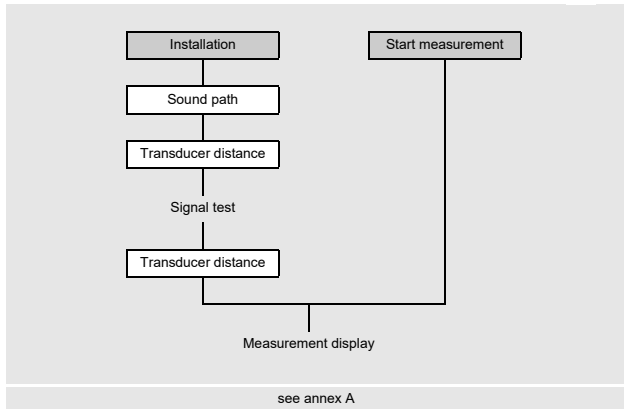

Before starting the measurement, the measuring point has to be parameterized. If another measurement has already been performed using the same measuring point parameters, the measurement can be started immediately.

- Select the menu `Start measurement`.
- Press ENTER.

The measurement is started. The measured values are displayed.

In case parameters or the measurement arrangement have changed, the measurement has to be started via the menu `Installation`.

- Select the menu `Installation`.
- Press ENTER.

If the list item `2 meas. points (A|B)` is selected in the menu item `Parameters\Measuring point config.`, the following settings are queried for each measuring point.

Calibration of the temperature calculation from the sound speed

The transmitter is able to calculate the temperature from the sound speed of the fluid during the measurement. The accuracy of the measured sound speed of the fluid depends on the accuracy of the entered parameters or on the mounting of the transducers.

If the temperature has to be calculated from the sound speed of the fluid during the measurement, a calibration based on the actual fluid temperature is carried out when starting the measurement. It has to be measured and entered in the transmitter. From the difference of the entered fluid temperature and the sound speed of the calculated fluid temperature an offset is determined and stored in the transmitter.

If the measurement is started the first time with activated calculation of the fluid temperature from the sound speed, the transmitter does not have stored any offset yet. The fluid temperature has to be entered.

```
Installation\Fluid temp.
```

- Enter the measured fluid temperature.
- Press ENTER.

This display will only be indicated if the calculation of the temperature offset is enabled in the menu item `Miscellaneous\Special settings\Fluid: c -> T`.

Notice!

After starting the measurement the determination of the offset can last up to 2 minutes (100 sound speed measurements are averaged).

Input of the sound path number

```
Installation\Sound path
```

- Enter the number of sound paths.
- Press ENTER.

Adjustment of the transducer distance

```
Installation\Transducer distance
```

The recommended transducer distance will be displayed. The transducer distance is measured between the inner edges of the transducers. In case of a measurement in diagonal arrangement on very small pipes, a negative transducer distance is possible.

Notice!

The accuracy of the recommended transducer distance depends on the accuracy of the entered pipe and fluid parameters.

- Mount the transducers on the pipe and adjust the recommended transducer distance.
- Press ENTER.

The diagnostics window is displayed.

The amplitude of the received signal is displayed by bar graph AMP.

The bar graph SCNR shows the ratio of the useful signal an the correlated noise signal.

Fig. 9.1: Diagnostics window

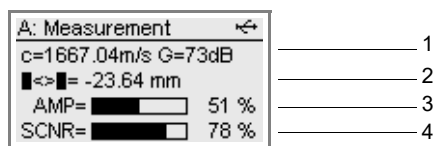

- 1 – diagnostic value, selection with
- 2 – diagnostic value, selection with
- 3 – amplitude (bar graph)
- 4 – SCNR value (bar graph)

Tab. 9.6: Diagnostic values

	display ⁽¹⁾	explanation
line 1 of the display, scroll with <input type="button" value="9"/>	c, G	measured sound speed of the fluid and signal gain
	SCNR	signal-to-correlated noise ratio
	SNR	signal-to-noise ratio
	Q	signal quality By pressing <input type="button" value="8"/> it is possible to display the numeric value instead of the bar graph.
	GAIN	signal gain If the current signal gain value exceeds the max. gain, it is followed by →FAIL!.
line 2 of the display, scroll with <input type="button" value="3"/>	■<>■	recommended transducer distance, in parentheses currently set transducer distance
	SCNR	signal-to-correlated noise ratio
	SNR	signal-to-noise ratio
	Q	signal quality By pressing <input type="button" value="2"/> it is possible to display the numeric value instead of the bar graph.

⁽¹⁾ In order to avoid doubling, a value already displayed in one of the lines will be ignored in the other.

- In case of large diagnostic value deviations of the recommended limits, check if the entered parameters are correct or repeat the measurement at a different point on the pipe.
- Press ENTER.

Tab. 9.7: Recommended diagnostic limits

good measurement	measurement at limit	measurement not possible
SCNR > 30 dB (> 50 %)	20 dB ≤ SCNR ≤ 30 dB (0 % < SCNR ≤ 50 %)	SCNR < 20 dB (= 0 %)
SNR > 15 dB	0 dB ≤ SNR ≤ 15 dB	SNR < 0 dB
GAIN < 98 dB	98 dB ≤ GAIN ≤ 113 dB	GAIN > 113 dB

Input of the transducer distance

Installation\Transducer distance

The recommended transducer distance is calculated on the basis of the measured sound speed. It is therefore a better approximation than the first recommended value which had been calculated on the basis of the parameters entered in the menu *Parameters*.

- Measure the adjusted transducer distance.
- Enter the measured transducer distance. The max. permissible difference to the recommended transducer distance must not be exceeded.
- Press ENTER.

The measurement is started. The measured values are displayed.

Tab. 9.8: Max. permissible deviation between the recommended and entered transducer distance

transducer frequency (3rd character of the technical type)	max. difference between the recommended and entered transducer distance [mm]	
	shear wave transducer	Lamb wave transducer
F	-	-60...+120
G	20	-45...+90
H	-	-30...+60
K	15	-20...+40
M	10	-10...+20
P	8	-5...+10
Q	6	-3...+5
S	3	-

9.4 Display during the measurement

9.4.1 Measured value

The measured values are displayed during the measurement as follows:

Fig. 9.2: Display of measured values

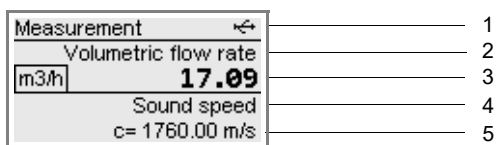

- 1 – menu, status indications
- 2 – physical quantity
- 3 – unit of measurement and measured value
- 4 – further physical quantities
- 5 – further physical quantities

By pressing or , additional physical quantities can be displayed during the measurement.

- Press to display the measured values in line 5. The designation of the physical quantity is displayed in line 4 by pressing for several seconds.
- Press to display the measured values in line 4. The designation of the physical quantity is displayed in line 5 by pressing for several seconds.

toggling between the measuring channels

If 2 meas. points (A|B) is selected for the configuration of the measuring point, the measurement is started on several measuring channels. The display of the measured values can be adapted as follows:

AutoMux mode

The measured values of all activated measuring channels are displayed consecutively in the AutoMux mode. The next activated measuring channel is selected after min. 3 s. The toggle time can be changed in the menu item *Miscellaneous\Dialogs/Menu\Toggle time*.

HumanMux mode

The measured values of one single measuring channel are displayed in the HumanMux mode. The measurement on the other measuring channels continues.

- Press to display the next activated measuring channel. The measured values for the selected measuring channel are displayed.

Each measurement starts in AutoMux mode. Press to toggle between the modes.

9.4.2 Status line

Important information of the running measurement is summarized in the status line. The quality and precision of the measurement can be evaluated. Press during the measurement to scroll to the status line.

Fig. 9.3: Display of the status line

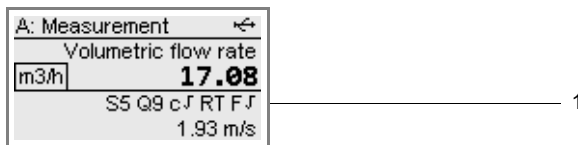

1 – status line

Tab. 9.9: Description of the status line

	value	explanation
S	0 ... 9	signal amplitude < 5 % ... ≥ 90 % values ≥ 3 are sufficient for the measurement
Q	0 ... 9	signal quality < 5 % ... ≥ 90 %
c	√ ↑ ↓ ?	sound speed comparison of the measured and the expected sound speed of the fluid The expected sound speed is calculated from the fluid parameters. OK, is equal to the expected value > 20 % of the expected value < 20 % of the expected value unknown, cannot be measured

Tab. 9.9: Description of the status line

	value	explanation
R		flow profile information about the flow profile based on the Reynolds number
	T	fully turbulent flow profile
	L	fully laminar flow profile
	↓	transition range between laminar and turbulent flow
	?	unknown, cannot be calculated
F		flow velocity comparison of the measured flow velocity with the flow limits of the system
	√	OK, the flow velocity is not within the critical range
	↑	the flow velocity is above the current limit
	↓	the flow velocity is below the current cut-off flow
	0	the flow velocity is within the limit range of the measuring method
	?	unknown, cannot be measured

9.4.3 Diagnostic values

The diagnostic values from Tab. 9.6 can be displayed during the measurement.

- Press ENTER to return to the diagnostics window.
- If the measurement is started on several measuring channels, press ENTER to change to the diagnostics window for measuring channel B.
- Press ENTER to return to the display of measured values.

9.4.4 Parameter

Transducer temperature

In the SuperUser and SuperUser ext. modes it is possible to display the transducer temperature during the measurement.

By pressing during the measurement, it is possible to scroll to the transducer temperature display.

Fig. 9.4: Display of the transducer temperature

Measurement	
Volumetric flow rate	
m ³ /h	393.25
SENSOR= 21 °C	
Transducer temp.	

Notice!

If the compliance of the specified transducer temperature has to be monitored, an event trigger can be set on the temperature value.

Parameter settings

The parameter settings can be displayed during the measurement.

- Press  during the measurement.

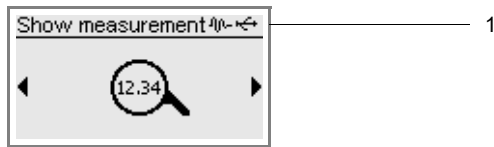

The transmitter returns to the main menu.

Fig. 9.5: Display of the main menu during the measurement



1 – status indication

The measurement is running in the background. The symbol  is displayed in the status indication.

- Press  4 or  6 to select the corresponding menu to display the parameters.

Notice!

The parameters cannot be changed during the measurement. When attempting to change the parameters, the message `Read-only mode` will be displayed.

The measurement has to be stopped in order to change the parameters.

Information regarding the data logger

Information regarding the data logger can be displayed during the measurement.

- Press  9 until the following is displayed.

Fig. 9.6: Information regarding the data logger



If the ringbuffer is deactivated, line 4 indicates when the data logger will be full in case all settings are kept.

If the ringbuffer is activated, line 4 indicates how long measurement data can still be stored without losing older measurement data.

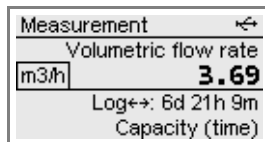
The information regarding the data logger can also be displayed via the menu `Storage`.

```
Storage\Data logger\Data logger info
```

- Press  during the measurement.
- Select the list item `Data logger\Data logger info` in the menu `Storage`.
- Press ENTER.

The information regarding the data logger are displayed.

Display of the current temperature offset

If the calculation of the fluid temperature from the sound speed is activated, the temperature offset can be displayed during the measurement.

Miscellaneous\Special settings\Fluid: c -> T

- Press  during the measurement.
- Select the menu item `Special settings` in the menu `Miscellaneous`.
- Press ENTER until the menu item `Fluid: c -> T` is displayed.

The following display appears:

Fig. 9.7: Display of the temperature offset

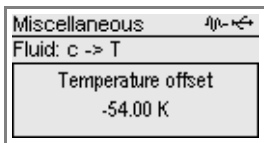

9.4.5 Return to display of measured values









- Press and hold  to return to the main menu.
- Select the menu item `Show measurement`.
- Press ENTER.

The measured values are displayed.

9.5 Execution of special functions

Some of the keys have special functions. They can be used to enter data, to navigate through scroll lists and to execute special functions.

Tab. 9.10: Special functions

key	function
	toggling between the AutoMux and HumanMux mode ⁽¹⁾
	totalizer display
	triggering of snaps
	press and hold to toggle between the alternating and standard measured values display (only for thermal energy rate measurement)
	toggling between the displays of the activated measuring channels ⁽¹⁾
	toggling between the TransitTime and the FastFood mode
	toggling between the TransitTime and the NoiseTrek mode
	toggling to the main menu, stop of measurement of parameter display
ENTER	display of the diagnostic window

⁽¹⁾ only if 2 meas. points (A|B) is selected for the configuration of the measuring point

Some functions can be executed in context. If 2 meas. points (A|B) is selected for the configuration of the measuring point, the functions of the measuring channel that was last visible on the display are executed.

- Press and hold C until the menu item `Execute command` is displayed.

Totalizers

```
Measurement\Execute command\Totalizers
```

- Select the list item `Totalizers`.
- Press ENTER.

The following scroll list appears:

display	description
Reset totalizers	reset the totalizer to zero
Freeze display	display the measured value of the totalizer for several seconds
Reset error	reset the totalizer error
Stop/clear totalizers	stop totalizer and reset it to zero
Start totalizers	start totalizer

Measuring mode

If the `NoiseTrek` or `FastFood` mode is enabled, it is possible to toggle between them or the `TransitTime` mode.

```
Measurement\Execute command\Measuring mode
```

- Select the list item `Measuring mode`.
- Press ENTER.
- Select a measuring mode from the list.
- Press ENTER.

Channel toggling

If `2 meas. points (A|B)` is selected for the configuration of the measuring point, the display of the measured values can be adapted as follows:

```
Measurement\Execute command\Channel toggling
```

- Select the list item `Channel toggling`.
- Press ENTER.

During the measurement, the measured values of measuring channel A or B can be displayed or it is toggled automatically between these measuring channels.

- Select a list item for measuring channel toggling.
- Press ENTER.

Taking a snap

```
Measurement\Execute command\Take a snap
```

- Select the list item `Take a snap`.
- Press ENTER.

A snap is taken.

Reset the event trigger to idle state

Measurement\Execute command\Clear alarms

- Select the list item `Clear alarms`.
- Press ENTER.

This display will only be indicated if an event trigger has been parameterized and at least one event trigger has also been triggered.

Toggleing between standard and alternating measured value display (only for thermal energy rate measurement)

Measurement\Execute command\Display toggling on

- Select the list item `Display toggling on` to activate the automatic toggling of the measured value display.
- Press ENTER.

Measurement\Execute command\Display toggling off

- Select the list item `Display toggling off` to deactivate this function.
- Press ENTER.

9.6 Stop of measurement

- Press and hold  to return to the main menu.
- Select the menu `Stop measurement`.

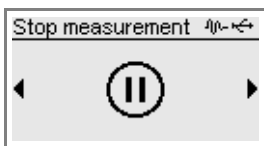

- Press ENTER.
- Select `Yes` to stop the measurement.
- Press ENTER.

The measurement is stopped. The main menu will be displayed.

10 Troubleshooting

Danger!



Risk of explosion when using the measuring equipment in explosive atmospheres

This may result in personal or material damage or dangerous situations.

→ Observe the "Safety instructions for the use in explosive atmospheres".

Warning!



Service works by unauthorized and unqualified personnel

This may result in personal or material damage or dangerous situations.

→ Any work on the transmitter has to be carried out by authorized and qualified personnel.

Danger!



Working in mines or cramped confines

Risk of intoxication and/or asphyxiation because of emerging gases, risk of injuries because of cramped conditions.

→ Wear the required personal protective equipment.

→ Observe the applicable rules.

Caution!



Safety and accident prevention regulations for electrical systems and equipment

Failure to observe these regulations may lead to severe injuries.

→ Observe the safety and accident prevention regulations for electrical systems and equipment.

Warning!



Touching live parts

Electric shock or arc faults can lead to severe injuries. The measuring equipment can be damaged.

→ Prior to any work on the transmitter (e.g., installation, dismounting, connection, start-up), the transmitter has to be disconnected from the power supply. It is not sufficient to remove the internal fuse of the instrument.

Caution!



Touching hot or cold surfaces

This may result in injuries (e.g., thermal damages).

→ Observe the ambient conditions at the measuring point during installation.

→ Wear the required personal protective equipment.

→ Observe the applicable rules.

If any problem appears which cannot be solved with the help of this operating instruction, contact our sales office and give a precise description of the problem. Specify the type, the serial number and the firmware version of the transmitter.

The display does not work at all or fails regularly.

- Check the contrast setting of the transmitter or enter the HotCode **555000** to set the display to medium contrast.
- Make sure that the correct voltage is available at the terminals. The destined transmitter voltage is indicated on the nameplate below the outer right terminal strip.
- If the power supply is OK, the transducers or an internal component of the transmitter are defective. The transducers and the transmitter have to be sent to FLEXIM for repair.
- If the transmitter is only connected via the USB interface, the backlight will be switched off.

An error is displayed in the status indication (symbol ).

- Press  to return to the main menu.
- Select the menu item `Storage\Event log`.
- Press ENTER.

The error message list will be displayed.

Date and time are wrong, the measured values are deleted when the transmitter is switched off.

- If the date and the time are reset or wrong or the measured values are deleted after the transmitter has been switched off and on again, the data backup battery has to be replaced. Send the transmitter to FLEXIM.

An output does not work.

- Make sure that the outputs are configured correctly. Check the function of the output. If the output is defective, contact FLEXIM.

10.1 Problems with the measurement

A measurement is not possible because no signal is received. An interrogation point is displayed after the physical quantity. The LED lights red after starting the measurement.

- Check whether the entered parameters are correct, especially the outer pipe diameter, the pipe wall thickness and the sound speed of the fluid. Typical errors: The circumference or the radius was entered instead of the diameter. The inner pipe diameter was entered instead of the outer pipe diameter.
- Check the number of sound paths.
- Make sure that the recommended transducer distance was adjusted when mounting the transducers.
- Make sure that an appropriate measuring point is selected and the number of sound paths was entered correctly.
- Try to establish a better acoustic contact between the pipe and the transducers.
- Enter a lower value for the number of sound paths. The signal attenuation might be too high due to a high fluid viscosity or deposits on the inner pipe wall.

The measuring signal is received but no measured values can be obtained.

- If the defined upper limit of the flow velocity is exceeded or the lower limit is below, `UNDEF` and after the physical quantity an exclamation point will be displayed. The measured values are marked as invalid. The limit has to be adapted to the measuring conditions.
- If no exclamation point is displayed, a measurement at the selected measuring point is impossible.

The signal is lost during the measurement.

- If there is no measuring signal after the pipe had been run empty and refilled, contact FLEXIM.
- Wait a moment until the acoustic contact is reestablished. The measurement can be interrupted due to a temporarily higher proportion of gas bubbles and solids in the fluid.

The measured values substantially differ from the expected values.

- Wrong measured values are often caused by wrong parameters. Make sure that the parameters entered for the measuring point are correct.

10.2 Measuring point selection

- Make sure that the recommended min. distance to any disturbance is observed.
- Avoid measuring points with deposit formation in the pipe.
- Avoid measuring points in the vicinity of deformations and defects on the pipe as well as welds.
- Make sure the pipe surface at the selected measuring point is even.
- Measure the temperature at the measuring point and make sure that the transducers are suitable for this temperature.
- Make sure that the outer pipe diameter is within the measuring range of the transducers.
- When measuring on a horizontal pipe, the transducers have to be mounted laterally on the pipe.
- A vertical pipe always has to be filled at the measuring point and the fluid should flow upward.
- No gas bubbles should form (even bubble-free fluids can form gas bubbles when the fluid expands, e.g., upstream of pumps and downstream of great cross-section enlargements).

10.3 Maximum acoustic contact

- see section 6.2

10.4 Application-specific problems

A fluid with a wrong sound speed was selected.

- If the selected sound speed in the fluid does not match the actual one, the transducer distance may not be determined correctly.
- The fluid sound speed is used to calculate the transducer distance and is therefore very important for the transducer positioning. The sound speeds stored in the transmitter only serve as an orientation.

The entered pipe roughness is not appropriate.

- Check the entered value considering the pipe condition.

Measurements on pipes made of porous materials (e.g., concrete or cast iron) are only conditionally possible.

- Contact FLEXIM.

The pipe lining may cause problems during the measurement if it is not firmly attached to the inner pipe wall or consists of an acoustically absorbing material.

- Try to measure on a section of the pipe free from lining.

Highly viscous fluids strongly attenuate the ultrasonic signal

- The measurement of fluids with a viscosity of $> 1000 \text{ mm}^2/\text{s}$ is only conditionally possible.

Gas bubbles or solids present in high concentration in the fluid scatter and absorb the ultrasonic signal and thus attenuate the measuring signal

- A measurement is impossible if the value is $\geq 10 \%$. If the proportion is high, but $< 10 \%$, a measurement is only conditionally possible.

10.5 Significant deviations of the measured values

A fluid with a wrong sound speed was selected.

- If a fluid was selected whose sound speed does not match the actual one, a pipe wall signal can be mistaken for the measuring signal. The flow calculated by the transmitter on the basis of the wrong signal is very small or fluctuates around zero.

There is gas in the pipe.

- If there is gas in the pipe, the measured flow will be too high because both the liquid and the gas volume are measured.

The defined upper limit of the flow velocity is too low.

- All measured flow velocities that are greater than the upper limit will be ignored and marked as invalid. All quantities deviated from the flow velocity will also be indicated as invalid. If several correct measured values are ignored, the totalizer values will be too low.

The entered cut-off flow is too high.

- All flow velocities below the cut-off flow are set to zero. All derived quantities are also set to zero. The cut-off flow has to be set to a low value to be able to measure at low flow velocities (default: 2.5 cm/s).

The entered pipe roughness is not appropriate.

The flow velocity of the fluid is outside the measuring range of the transmitter.

The measuring point is not appropriate.

- Check whether a different measuring point provides better results. Because pipes are never rotationally symmetric and the flow profile is affected.

10.6 Problems with the totalizers

The values of the totalizers are too small.

- One of the totalizers has reached the upper limit and has to be reset to zero manually.

The sum of the totalizers is not correct.

- The sum of both totalizers (throughput ΣQ) transmitted via an output is not valid after one of the totalizers has overflowed for the first time.

An interrogation point is displayed after the value of the totalizer.

- The measurement was temporarily impossible, therefore the totalizer value can be wrong.

10.7 Problems during the thermal energy rate measurement

The measured fluid temperatures differ from the actual values.

- The temperature probes are not sufficiently insulated.
- On a pipe with a small diameter, the temperature probe is lifted from the pipe surface by the insulation foam.

The measured absolute value of the thermal energy rate is correct but has the opposite sign.

- Check the assignment of the supply and return temperature to the temperature inputs.

The calculated thermal energy rate differs from the actual one although the measured flow and temperature values are correct

- Check the thermal energy rate coefficient of the fluid.

11 Maintenance and cleaning

Danger!



Risk of explosion when using the measuring equipment in explosive atmospheres

This may result in personal or material damage or dangerous situations.

→ Observe the "Safety instructions for the use in explosive atmospheres".

Warning!



Service works by unauthorized and unqualified personnel

This may result in personal or material damage or dangerous situations.

→ Any work on the transmitter has to be carried out by authorized and qualified personnel.

Danger!



Working in mines or cramped confines

Risk of intoxication and/or asphyxiation because of emerging gases, risk of injuries because of cramped conditions.

→ Wear the required personal protective equipment.

→ Observe the applicable rules.

Warning!



Touching live parts

Electric shock or arc faults can lead to severe injuries. The measuring equipment can be damaged.

→ Prior to any work on the transmitter (e.g., installation, dismantling, connection, start-up), the transmitter has to be disconnected from the power supply. It is not sufficient to remove the internal fuse of the instrument.

Caution!



Safety and accident prevention regulations for electrical systems and equipment

Failure to observe these regulations may lead to severe injuries.

→ Observe the safety and accident prevention regulations for electrical systems and equipment.

Caution!



Touching hot or cold surfaces

This may result in injuries (e.g., thermal damages).

→ Observe the ambient conditions at the measuring point during installation.

→ Wear the required personal protective equipment.

→ Observe the applicable rules.

11.1 Maintenance

The transmitter and the transducers are practically maintenance-free. In order to ensure security, the following maintenance intervals are recommended:

Tab. 11.1: Recommended maintenance intervals

item	maintenance step	interval	measure
stainless steel housing • transmitter • junction box • transducer mounting fixture	visual inspection for corrosion and damages	annually or more frequently, depending on the ambient conditions	cleaning
	visual inspection for contamination	annually or more frequently, depending on the ambient conditions	
aluminum housing • transmitter	visual inspection for contamination	annually or more frequently, depending on the ambient conditions	
transducers	check of the transducer coupling on the pipe	annually	replacement of coupling foil, if necessary
transmitter	check for firmware updates	annually	update, if necessary
transmitter	functional test	annually	reading of measured and diagnostic values
transmitter and transducers	calibration	-	see section 11.3

11.2 Cleaning

Stainless steel housing

- Clean the housing with a soft cloth and care and cleaning spray for stainless steel.

Aluminum housing

- Clean the housing with a soft cloth. Do not use detergents.

Transducers

- Remove traces of coupling compound from the transducers with a soft paper towel.

11.3 Calibration

If installed as recommended in an appropriate location, used cautiously and serviced conscientiously, no troubles should appear.

The transmitter has been calibrated at factory and, usually, a recalibration is not necessary.

A recalibration is recommended if:

- the contact surfaces of the transducers show visible wear
- the transducers were used for a prolonged period at high temperatures (several months > 130 °C for normal transducers or > 200 °C for high temperature transducers)

In order to realize a recalibration under reference conditions, either the transmitter, the transducers or both have to be sent to FLEXIM.

11.4 Firmware update

A firmware update is carried out with FluxDiagReader or FluxDiag (option).

- For the connection of the transmitter to a PC, see section 7.6.
- For the operation of FluxDiagReader or FluxDiag see the help functions of these programs.

12 Dismounting and disposal

Danger!



Risk of explosion when using the measuring equipment in explosive atmospheres

This may result in personal or material damage or dangerous situations.

→ Observe the "Safety instructions for the use in explosive atmospheres".

Warning!



Installation, connection and start-up by unauthorized and unqualified personnel

This may result in personal or material damage or dangerous situations.

→ Any work on the transmitter has to be carried out by authorized and qualified personnel.

Danger!



Working in mines or cramped confines

Risk of intoxication and/or asphyxiation because of emerging gases, risk of injuries because of cramped conditions.

→ Wear the required personal protective equipment.

→ Observe the applicable rules.

Warning!



Touching live parts

Electric shock or arc faults can lead to severe injuries. The measuring equipment can be damaged.

→ Prior to any work on the transmitter (e.g., installation, dismounting, connection, start-up), the transmitter has to be disconnected from the power supply. It is not sufficient to remove the internal fuse of the instrument.

Caution!



Safety and accident prevention regulations for electrical systems and equipment

Failure to observe these regulations may lead to severe injuries.

→ Observe the safety and accident prevention regulations for electrical systems and equipment.

12.1 Dismounting

Dismounting is carried out in reverse order to the installation.

12.2 Disposal

The measuring equipment has to be disposed of in accordance with the applicable regulations.

Important!

Proper disposal of components of the transmitter and accessories that are no longer required avoids environmental damage and conserves resources.

Depending on the material, the corresponding parts have to be disposed of in residual or special waste or recycled in accordance with the applicable regulations.

Batteries must be disposed of separately from electrical or electronic equipment. For this purpose, remove the batteries from the device and take them to the designated disposal system.

The components are taken back free of charge by FLEXIM in accordance with national regulations. Contact FLEXIM.

13 User modes

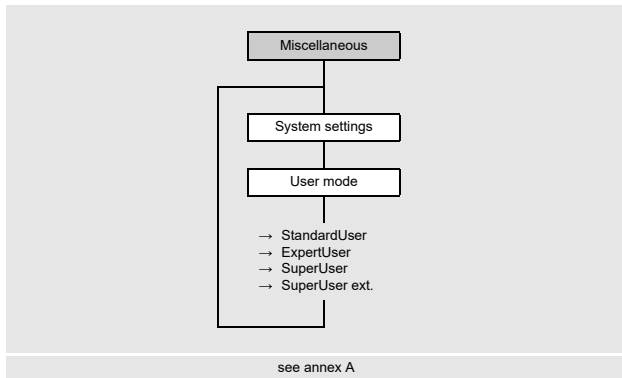

The user modes allow extended diagnostics of signals and measured values as well as the definition of additional parameters adapted to the application.

The following user modes can be selected:

- StandardUser
- ExpertUser
- SuperUser
- SuperUser ext.

Depending on the selected user mode, different menu items are displayed within the menu Calibration and the menu item Miscellaneous\Special settings:

Tab. 13.1: Menu items of the user modes

menu item	StandardUser	ExpertUser	SuperUser	SuperUser ext.	default
in menu item Miscellaneous\Special settings					
Enable NoiseTrek	x	x	x	x	Off
Start in meas. mode	x	x	x	x	
Pig detection			x	x	Off
Turbulence mode	x	x	x	x	Off
Max. gain		x	x	x	Off
Pipe signal detection		x	x	x	On
Fluid: c -> T	x	x	x	x	Off
in menu Calibration					
Cut-off flow	x	x	x	x	On
Flow velocity limit		x	x	x	Off
LWT pipe wall calibr.			x	x	Off
Linear calibration			x	x	Off
Profile correction		x	x	x	On
Weighting factor			x	x	Off
Multi-point calibration (if enabled in Miscellaneous\ Measurement\Measurement settings)	x	x	x	x	
as list item in menu item Outputs\...\Source item\Diagnostic values					
Transducer temp.			x	x	
Transd. temp. violat.			x	x	
as source item during channel-based parametrization in menu Outputs					
Extended diagnostics			x	x	

User mode selection

Miscellaneous\System settings\User mode

- Select the menu item `User mode`.
- Press ENTER.
- Select a list item.
- Press ENTER.

13.1 StandardUser mode

In the StandardUser mode, all measurements can be carried out for the corresponding application. At the first start-up the transmitter operates in the StandardUser mode.

13.1.1 NoiseTrek mode

If the proportion of gas or solid particles is high, the transmitter can toggle to the NoiseTrek mode.

Notice!

Due to its higher measuring accuracy, the TransitTime mode should be preferred to the NoiseTrek mode.

In the NoiseTrek mode it is not possible to determine the sound speed in the fluid.

The following diagnostic values are not available in the NoiseTrek mode: signal quality, amplitude fluctuation, transit time fluctuation, pig detection.

Miscellaneous\Special settings\Enable NoiseTrek

- Select the menu item `Special settings` in the menu `Miscellaneous`.
- Press ENTER until the menu item `Enable NoiseTrek` is displayed.
- Select `Default` if no customized inputs are to be made.
- Select `On` to enable the NoiseTrek mode. Select `Off` to disable it.
- Press ENTER.

If `On` has been selected, the following list items are available:

- `Manual`
- `HybridTrek`
- `Parallel beam`

If the synchronized channel averaging is activated in the menu item `Miscellaneous\Measurement\Measurement modes\Synch. chan. averag.`, this function will not be available.

13.1.1.1 Manual

In order to manually toggle between the TransitTime and the NoiseTrek mode during the measurement, press when the measured value is displayed.

13.1.1.2 HybridTrek mode

The HybridTrek mode combines the TransitTime and the NoiseTrek mode. During a measurement in the HybridTrek mode, the transmitter automatically toggles between the TransitTime and the NoiseTrek mode depending on the proportion of gas bubbles and solid particles in the fluid in order to receive valid measuring values.

If the NoiseTrek mode is enabled, the menu item `HybridTrek` will be displayed.

Miscellaneous\Special settings\HybridTrek

- Select `On` to activate the automatic toggling between the TransitTime and the NoiseTrek mode. If `On` is selected, the NoiseTrek mode can also be activated and deactivated manually during the measurement.
- Select `Off` to deactivate the automatic toggling between the TransitTime and the NoiseTrek mode. If `Off` is selected, the NoiseTrek mode can only be manually activated and deactivated during the measurement.
- Press ENTER.

```
Miscellaneous\Special settings\HybridTrek\TT -> NT
```

If the automatic toggling between the TransitTime and NoiseTrek mode is activated, further parameters have to be configured.

- Enter the time after which the transmitter has to toggle to the NoiseTrek mode if there are no valid measured values in the TransitTime mode.
- Press ENTER.

```
Miscellaneous\Special settings\HybridTrek\NT -> TT
```

- Enter the time after which the transmitter has to toggle from the NoiseTrek to the TransitTime mode if there are no valid measured values.
- Press ENTER.

```
Miscellaneous\Special settings\HybridTrek\NT -> TT possible
```

If there are valid measured values in the NoiseTrek mode, the transmitter can periodically toggle to the TransitTime mode in order to check whether a measurement in the TransitTime mode is possible again. The time interval and the checking duration are set as follows:

- Enter the time after which the transmitter has to toggle to the TransitTime mode. If zero is entered, the transmitter does not toggle to the TransitTime mode.
- Press ENTER.

```
Miscellaneous\Special settings\HybridTrek\Keep TT
```

- Enter the time after which the transmitter has to toggle from the TransitTime mode back to the NoiseTrek mode if there are no valid measured values.
- Press ENTER.

Example

```
TT -> NT: 40 s  
NT -> TT: 60 s  
NT -> TT possible: 300 s  
Keep TT: 5 s
```

If no measurement is possible in the TransitTime mode within 40 s, the transmitter toggles to the NoiseTrek mode. If no measurement is possible in the NoiseTrek mode within 60 s, the transmitter toggles back to the TransitTime mode.

If valid measured values are obtained during the measurement in the NoiseTrek mode, the transmitter toggles to the TransitTime mode every 300 s. If no measurement is possible in the TransitTime mode within 5 s, the transmitter toggles back to the NoiseTrek mode. If a valid measured value is obtained in the TransitTime mode within 5 s, the transmitter continues the measurement in the TransitTime mode.

13.1.1.3 NoiseTrek parallel beam mode

The NoiseTrek parallel beam mode works with parallel mounted transducers. It improves the signal quality when measuring on small pipes or with strongly attenuating fluids.

13.1.2 Start in measuring mode

For some application it is necessary to start the measurement in a particular measuring mode.

```
Miscellaneous\Special settings\Start in meas. mode
```

- Select the menu item `Special settings` in the menu `Miscellaneous`.
 - Press ENTER until the menu item `Start in meas. mode` is displayed.
- The menu item `Start in meas. mode` will only be displayed if the `FastFood` or the `NoiseTrek` mode is enabled.
- Select `TransitTime`, `FastFood` or `NoiseTrek` to start the measurement in the corresponding mode.
 - Press ENTER.

```
Miscellaneous\Special settings\Start in meas. mode\Only ... mode
```

- Select `Yes` to keep always the same the measuring mode. Select `No` to select another measuring mode by pressing during the measurement.

The measuring modes `FastFood` and `NoiseTrek` can only be selected if they are available and activated in the transmitter. If the synchronized channel averaging is activated in the menu item `Miscellaneous\Measurement\Measurement modes\Synch. chan. averag.`, this function will not be available.

13.1.3 Turbulence mode

In the presence of high turbulence, i.e., high Reynolds numbers or disturbed flow profiles due to short inlet and outlet lengths, there are large fluctuations in the transit time of the ultrasonic signals, resulting in poor signal quality (e.g., reduction in signal amplitude, increase in gain). An unstable measurement with frequent signal losses and diagnostic values `VariAmp` > 5 % indicate strong turbulence. Here it can be helpful to activate the turbulence mode.

Requirement for a measurement with activated turbulence mode

- The SNR has to be > 15 dB with deactivated turbulence mode.
- The signal gain with activated turbulence mode is min. 3 dB smaller than with deactivated turbulence mode. For this purpose, the signal gain must be measured in each case at flow velocities at the operating point where strong turbulence is suspected.

If these criteria are fulfilled, the specified measurement uncertainty can also be met with activated turbulence mode.

If they are not fulfilled, the measurement with deactivated turbulence mode is to be preferred.

```
Miscellaneous\Special settings\Turbulence mode
```

- Select the menu item `Special settings` in the menu `Miscellaneous`.
- Press ENTER until the menu item `Turbulence mode` is displayed.
- Select `On` to activate the turbulence mode. Select `Off` to deactivate it. Select `Default` if no customized inputs are to be made.
- Press ENTER.

13.1.4 Calculation of the fluid temperature from the sound speed of the fluid

```
Miscellaneous\Special settings\Fluid: c -> T
```

- Select the menu item `Special settings` in the menu `Miscellaneous`.
- Press ENTER until the menu item `Fluid: c -> T` is displayed.
- Select `On` if the calculated fluid temperature from the sound speed has to be calculated. Select `Off` if not.
- Press ENTER.

13.1.5 Cut-off flow

The cut-off flow is a lower limit for the flow velocity. All measured flow velocities that are below the limit are set to zero. The cut-off flow can depend on the flow direction.

```
Calibration\Cut-off flow
```

- Select the menu item `Calibration\Cut-off flow`.
- Press ENTER.
- Select `Off` if no value is to be entered for the cut-off flow.
- Select `Default` if no customized inputs are to be made (default: ± 25 mm/s).
- Select `Customized` to define the values of the cut-off flow for the positive and negative flow direction.
- Press ENTER.

```
Calibration\Cut-off flow\Customized\+Cut-off flow
```

All values of the flow velocity for the positive flow direction below this limit are set to zero.

- Enter the cut-off flow.
- Press ENTER.

```
Calibration\Cut-off flow\Customized\ -Cut-off flow
```

All values of the flow velocity for the negative flow direction (as absolute value) below this absolute limit are set to zero.

- Enter the cut-off flow as absolute value.
- Press ENTER.

13.1.6 Multi-point calibration

It is possible to enter a series of measured values in order to define a calibration curve for the flow velocity.

Record of a series of measured values:

- Start a measurement with the transmitter and a reference flowmeter.
- Gradually increase the value of the flow velocity. The measuring range of values has to be identical with the eventual operating range.
- Note or store the measured values.

Input of a series of measured values:

- Activate the multi-point calibration in the menu item `Miscellaneous\Measurement\Measurement settings`.
- Select the menu item `Multi-point calibration` in the menu `Calibration`.
- Press ENTER.

```
Calibration\Multi-point calibration
```

- Select `Yes` to define the calibration curve. Select `No` to measure without calibration.
- Press ENTER.

```
Calibration\Multi-point calibration\Calibration points
```

- Enter the number of pairs of measured values.
- Press ENTER.

Calibration\Multi-point calibration\Point x=act. value

- Enter the measured value of the transmitter.
- Press ENTER.

Calibration\Multi-point calibration\Point x=set value

- Enter the measured values of the reference flowmeter.
- Press ENTER.
- Repeat the input for all pairs of measured values.
- Press ENTER after each input.

Calibration\Multi-point calibration\Bidirectional use

- Select **Yes** to apply the calibration curve for negative flow velocities as well. Select **No** if it is not to be used for negative flow velocities.

13.2 ExpertUser mode

Some menu items that are not visible in the StandardUser mode are displayed.

Notice!

The ExpertUser mode is intended for experienced users with advanced application knowledge. Changed parameters can affect the StandardUser mode and lead to wrong measured values or to a measurement failure when setting up a new measuring point.

Notice!

Some of the defined parameters remain activated when switching to the StandardUser mode. These parameters are displayed but cannot be changed.

13.2.1 Profile correction

It is possible to select the following versions for the calculation of the fluid mechanic calibration factor k_{Re} :

- k_{Re} 1.0: profile correction (previous version)
- k_{Re} 2.0: improved profile correction (current version)
- k_{Re} 2.0 disturb. corr.: improved profile correction at non ideal inflow conditions for the positive flow direction (negative flow direction without disturbance correction, default)
- k_{Re} 2.0 dist.corr.bidir.: improved profile correction at non ideal inflow conditions for the positive and negative flow direction (automatic toggling of the profile correction depending on the flow direction)

The following steps are necessary to set the profile correction:

- selection of the profile correction version in the menu `Miscellaneous`

If k_{Re} 2.0 disturb. corr. or k_{Re} 2.0 dist.corr.bidir. is selected:

- selection of the disturbance in the menu `Parameters`
- input of the disturbance distance in the menu `Parameters`

Notice!

If k_{Re} 2.0 disturb. corr. or k_{Re} 2.0 dist.corr.bidir. has been selected, the transducers have to be mounted in reflection arrangement, X arrangement or displaced X arrangement to compensate cross-flow effects.

Selection of the version

Miscellaneous\Measurement\Measurement settings\Profile correction

- Select the menu item `Measurement\Measurement settings` in the menu `Miscellaneous`.
- Press `ENTER` until the menu item `Profile correction` is displayed.
- Select a list item (default: `kRe 2.0 disturb. corr.`).
- Press `ENTER`.

Selection of the disturbance

Parameters\Disturbance type

- Select a list item.
- Press `ENTER`.

If `kRe 2.0 disturb. corr.` or `kRe 2.0 dist.corr.bidir.` is selected, the disturbance parameters have to be entered.

Tab. 13.2: Disturbance parameters

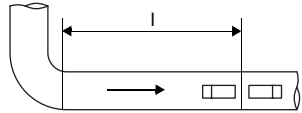
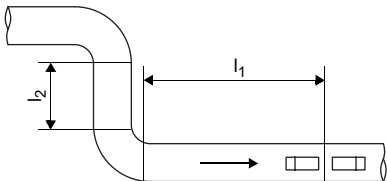
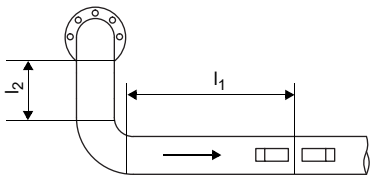
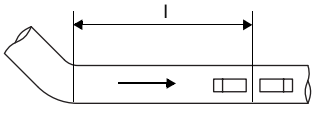
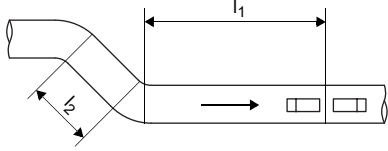
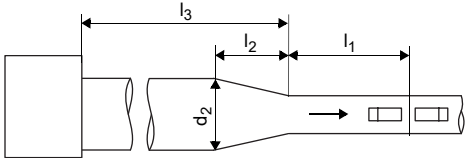
disturbance type	parameter	description
90° elbow	Disturbance distance (l)	
90° double elbow	Disturbance distance (l_1) Dist. between elbows (l_2)	
90° doub.elb. out of plane	Disturbance distance (l_1) Dist. between elbows (l_2)	
45° elbow	Disturbance distance (l)	
45° double elbow	Disturbance distance (l_1) Dist. between elbows (l_2)	
Reducer	Disturbance distance (l_1) Reducer length (l_2) Inlet outer diameter (d_2) additional with reducer with upstream disturbance Add. disturb. distance (l_3) Add. upstream disturb. (e.g., 90° elbow) upstream disturbance parameters	

13.2.2 Max. signal gain

In order to prevent disturbing and/or pipe wall signals (e.g., if the pipe has run empty) from being interpreted as useful signals, it is possible to define a max. signal gain.

If the signal gain is greater than the max. signal gain:

- the physical quantity cannot be determined and the measured value is marked as invalid
- a hash symbol will be displayed after the unit of measurement (in case of a normal error, an interrogation point is displayed)

Miscellaneous\Special settings\Max. gain

- Select the menu item `Special settings` in the menu `Miscellaneous`.
- Press ENTER until the menu item `Max. gain` is displayed.
- Select `Off` if no limit of the signal gain is to be used.
- Select `Default` if no customized inputs are to be made.
- Select `Customized` to define a limit for the max. gain.
- Press ENTER.
- Enter a value for the max. signal gain.
- Press ENTER.

13.2.3 Pipe signal detection

When evaluating the plausibility of the signal, it is checked whether the sound speed is within a defined range. The absolute threshold of the fluid sound speed used is calculated from the greatest of the following values:

- absolute threshold, default value: 1848 m/s
- value of the sound speed curve of the fluid at the operating point plus relative threshold, default relative threshold: 200 m/s

Miscellaneous\Special settings\Pipe signal detection

- Select the menu item `Special settings` in the menu `Miscellaneous`.
- Press ENTER until the menu item `Pipe signal detection` is displayed.
- Select `Off` to measure without pipe signal detection.
- Select `Default` if no customized inputs are to be made and the default values are to be used.
- Select `Customized` to define the values of the pipe signal detection.
- Press ENTER.

Miscellaneous\Absolute threshold

- Enter the value of the absolute threshold.
- Press ENTER.

Miscellaneous\Relative threshold

- Enter the value for the relative threshold.
- Press ENTER.

Example

absolute threshold: 2007 m/s

relative threshold: 600 m/s

value of the sound speed curve at the measuring point: 1546 m/s

As $1546 \text{ m/s} + 600 \text{ m/s} = 2146 \text{ m/s}$ is greater than the absolute value 2007 m/s, this value will be used as the absolute limit of the sound speed when the plausibility of the signal is evaluated.

13.2.4 Limit of the flow velocity

Single outliers caused by heavily disturbed surroundings can appear among the measured values of the flow velocity. If these outliers are not ignored, they will affect all derived physical quantities, which will be unsuitable for the integration (e.g., pulse outputs).

In the ExpertUser mode it is possible to enter a limit for the flow velocity.

It is possible to ignore all measured flow velocities higher or lower than the preset limit. In this case an error will be output.

Calibration\Flow velocity limit

- Select the menu item `Flow velocity limit` in the menu `Calibration`.
- Press `ENTER`.
- Select `Off` if no limit for the flow velocity is to be used.
- Select `Default` if no customized inputs are to be made.
- Select `Customized` to define a limit for the flow velocity.
- Press `ENTER`.

Calibration\+Flow velocity limit

- Enter a limit of the flow velocity for the measurement in flow direction.
- Press `ENTER`.

If the flow velocity is higher than this limit, it will be marked as invalid. The physical quantity cannot be determined. `UNDEF` will be displayed.

Calibration\ -Flow velocity limit

- Enter a limit of the flow velocity for the measurement against the flow direction.
- Press `ENTER`.

If the flow velocity is lower than this limit, it will be marked as invalid. The physical quantity cannot be determined. `UNDEF` will be displayed.

Notice!

If the limit of the flow velocity `+Flow velocity limit` is too low or `-Flow velocity limit` is too high, a measurement might be impossible because most of the measured values will be marked as invalid.

Fig. 13.1: Flow velocity outside the valid range

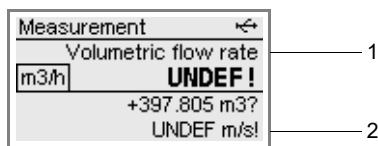

- 1 – physical quantity
- 2 – flow velocity

13.2.4.1 Measuring point specific profile correction

In special cases a measuring point specific profile correction can be used.

Calibration\Profile correction

- Select the menu item `Profile correction` in the menu `Calibration`.
- Press ENTER.
- Select `Off` to deactivate the profile correction.
- Select `Default` to use the global setting from the menu item `Miscellaneous\Measurement settings\Profile correction` for the profile correction.
- Select `Customized` to use a measuring point specific profile correction.
- Press ENTER.

In case the list item `Customized` has been selected, the parameters of the measuring point specific profile correction will now be displayed. The parameters of the profile correction are preferably transmitted to the transmitter via the service interface but can also be entered here.

13.3 SuperUser mode and SuperUser ext. mode

Some menu items that are not visible in the `StandardUser` or `ExpertUser` mode are now displayed.

In the `SuperUser ext. mode` it is not possible to carry out any plausibility test of the entered parameters.

Notice!

The `SuperUser` and `SuperUser ext. mode` is intended for experienced users with advanced application knowledge. Changed parameters can affect the `StandardUser` mode and lead to wrong measured values or to a failure of the measurement when setting up a new measuring point.

Notice!

Some of the defined parameters remain activated when switching to the `StandardUser` mode. These parameters are displayed but cannot be changed.

13.3.1 Pig detection

This function detects pigs inside the pipe. The pig detection can be activated/deactivated via the HotCode **007028** (default: deactivated).

If the list item `2 meas. points (A|B)` is selected in the menu item `Parameters\Measuring point config.`, the pig detection can be activated or deactivated differently from the global device setting for a measuring point.

Miscellaneous\Special settings\Pig detection

- Select the menu item `Special settings` in the menu `Miscellaneous`.
- Press ENTER until the menu item `Pig detection` is displayed.
- Select `Global settings` if the measurement is to be carried out using the global settings of the transmitter.
- If the pig detection is deactivated in the global device settings and the measurement is to be carried out with pig detection on a measuring channel, select `On` for this measuring channel.
- Press ENTER.
- If the pig detection is activated in the global device settings and the measurement is to be carried out without pig detection on a measuring channel, select `Off` for this measuring channel.
- Press ENTER.

13.3.2 Calculation of the fluid temperature from the sound speed of the fluid

Miscellaneous\Special settings\Fluid: c -> T

- Select the menu item `Special settings` in the menu `Miscellaneous`.
- Press ENTER until the menu item `Fluid: c -> T` is displayed.
- Select `On` if the calculated fluid temperature from the sound speed has to be calculated. Select `Off` if not.
- Press ENTER.

If the transmitter is operating in the `SuperUser` or `SuperUser ext. mode` and `On` is selected, options for temperature calculation will be displayed.

Miscellaneous\Special settings\Fluid: c -> T\Temperature meas.

- Select `With calibration` to realize a calibration for the temperature determination.
- From the difference between the entered fluid temperature and the sound speed of the calculated fluid temperature an offset is determined, when starting the measurement. The fluid temperature has to be entered.
- Press ENTER.
 - Select `Without calibration` if no measured value for the temperature is available.
 - Press ENTER.

Notice!

If the determination of the fluid temperature from the sound speed without calibration may lead to notable temperature deviations.

- Select `Customized` to enter an offset.
- Press ENTER.
- Enter the offset.
- Press ENTER.

13.3.3 Pipe wall calibration for Lamb wave transducers

The parameter record of a measuring channel for Lamb wave transducers has a calibration factor for the uncorrected flow velocity. This calibration factor depends on the pipe material.

The pipe wall calibration for Lamb wave transducers becomes effective if the following criteria are met when starting a measurement:

- Lamb wave transducers are used
- pipe wall calibration is activated
- a factor for the pipe material is defined and selected from the menu `Parameters`

The factor can be activated in the transmitter.

If the list item `1 meas. point (AB)` or `2 meas. points (A|B)` is selected in the menu item `Parameters\Measuring point config.`, the pipe wall calibration can be activated for each measuring point.

Calibration\LWT pipe wall calibr.

- Select the menu item `LWT pipe wall calibr.` in the menu `Calibration`.
- Press ENTER.
- Select `Off` to measure without pipe wall calibration.
- Select `Default` if no customized inputs are to be made.
- Select `On` to define the values for the pipe wall calibration.
- Press ENTER.

13.3.4 Linear calibration

It is possible to define a correction of the flow velocity:

$$v_{\text{cor}} = m \cdot v + n$$

where

- v – measured flow velocity
- m – factor, range: -2...+2
- n – offset, range: -12...+12 cm/s
- v_{cor} – corrected flow velocity

All quantities derived from the flow velocity will be calculated with the corrected flow velocity.

Notice!

It will not be displayed during the measurement that the correction of the flow velocity is activated.

Calibration\Linear calibration

- Select the menu item `Linear calibration` in the menu `Calibration`.
- Press ENTER.
- Select `Off` to measure without linear calibration.
- Select `Default` if no customized inputs are to be made.
- Select `On` to define the values for the calibration.
- Press ENTER.

Calibration\Factor

- Enter the factor for the linear calibration.
- Press ENTER.

Calibration\Offset

- Enter the offset for the linear calibration.
- Press ENTER.

Example

factor: 1.1

offset: -10 cm/s = -0.1 m/s

If a flow velocity $v = 5$ m/s is measured, before the calculation of the derived quantities it will be corrected as follows:

$$v_{\text{cor}} = 1.1 \cdot 5 \text{ m/s} - 0.1 \text{ m/s} = 5.4 \text{ m/s}$$

Example

factor: -1

offset: 0

Only the sign of the measured values changes.

13.3.5 Weighting factor

The weighting factor is used for transducers installed on the same pipe in order to compensate differences between the measured values of the flow velocity of different measuring channels.

The differences can be caused by profile deformations or cross-flows. These influences can be reduced by averaging the measured values of several channels. However, if a measuring channel has a temporary malfunction, the average will change abruptly. In order to avoid these changes, all measuring channels have to be adjusted with the weighting factor.

The weighting factor for the measuring channel x results from the flow velocity v_x measured on this channel and the average flow velocity v_m of all measuring channels:

$$w_x = \frac{v_m}{v_x}$$

The weighting factor can be activated in the transmitter.

If the list item 1 meas. point (AB) or Channel-based param. is selected in the menu item Parameters\Measuring point config., the weighting factor can be activated individually for each measuring channel.

Calibration\Weighting factor

- Select the menu item Calibration\Weighting factor.
- Press ENTER.
- Select Off to measure without the weighting factor.
- Select Default if no customized inputs are to be made.
- Select On to define the weighting factor.
- Press ENTER.

13.3.6 Transducer temperature and transducer temperature violation as diagnostic value

When configuring outputs, the list items Diagnostic values and Transducer temp. are available in the menu item Transd. temp. violat. The diagnostic values can either be transmitted via the output of the transmitter or defined as source of the event trigger.

Outputs\...\Source item

- Select Diagnostic values as source item.
- Press ENTER.
- Select a list item for the quantity to be output.
- Press ENTER.

Tab. 13.3: Source item Diagnostic values

source item	list item	output
Diagnostic values	Transducer temp.	average temperature of both transducers
	Transd. temp. violat.	status information: yes/no

13.3.7 Activation of measuring channels

Installation>Select channels

The measuring channels can be activated and deactivated.

- : the measuring channel is activated
- : the measuring channel is deactivated

This display will not be indicated if transmitter owns only 1 measuring channel or if the list item 1 meas. point (A) in the menu item Parameters\Measuring point config. is selected.

- Select a measuring channel with or .
- Press or to activate or deactivate the measuring channel.

13.3.8 Channel-based parametrization

Parameters\Measuring point config.\Channel-based param.

- Select the list item Channel-based param. in the menu item Parameters\Measuring point config.
- Press ENTER.
- Select the measuring channel for which the parameters are to be entered.
- Press ENTER.

For the description of further inputs, see section 9.1.

The parameter input has be realized for each measuring channel.

13.3.9 Calculation channels

Notice!

Calculation channels are only available if the transmitter has more than one measuring channel.

In addition to the ultrasonic measuring channels, the transmitter has 2 virtual calculation channels Y and Z which calculate the measured values of all measuring channels.

The result of the defined calculation function is the measured value of the selected calculation channel. This measured value is equivalent to the measured values of a measuring channel. All operations which are possible with the measured values of a measuring channel (totalizing, storing, output, etc.) can also be done with the measured values of a calculation channel.

13.3.9.1 Characteristics of the calculation channels

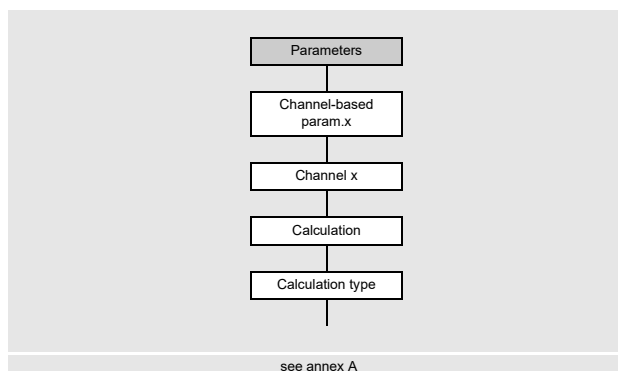

The measuring channels to be used for calculation and the calculation function have to be entered in the menu Parameters.

It is possible to define 2 cut-off flows for each calculation channel. The cut-off flow is not based on the flow velocity as is the case with the measuring channels. Instead, it is defined in the unit of measurement of the physical quantity selected for the calculation channel. During the measurement, the calculation values are compared with the cut-off values and set to zero, if necessary.

13.3.9.2 Parametrization of a calculation channel

Parameters\Measuring point config.\Channel-based param.\Channel Y

- Select the list item Channel-based param. in the menu item Parameters\Measuring point config.
- Press ENTER.
- Select a calculation channel (here: Channel Y).
- Press ENTER.

The current calculation function is displayed.

- Press ENTER.

Selection of the calculation type

Tab. 13.4: Calculation types

average (all chan. OK)	average (1 chan. OK)	special
mean with "AND" All measuring channels have to deliver a valid measuring value. calculation function: $Y = (A + B) / 2$	mean with "OR" At least one measuring channel has to deliver a valid measuring value. calculation function: $Y = (A + B) / n$	Each measuring channel selected for calculation can be assigned with a signed value.

FLUXUS *722:

If the synchronized channel averaging is activated in the menu item `Miscellaneous\Measurement\Measurement modes\Synch. chan. averag.`, the average can only be selected as calculation type (AND or OR operation).

`Parameters\Measuring point config.\Channel-based param.\Channel Y\Calculation type`

- Select a calculation type.
- Press ENTER.
- Assign a measuring channel to each source channel.
- Press ENTER after each selection.

Example

```

calculation type:          special
source channel 1:         Meas. Channel A
sign of source channel 1: |A|
source channel 2:         Meas. Channel B
sign of source channel 2: |B|
average:                  1/2 (AND)
linear correction:        Yes
factor:                   1.5 Factor
offset:                   2.0 m/s

calculation function:     1.5 * (|A|+|B|) / 2 + 2 m/s
    
```

Input of limits

It is possible to define limits for the physical quantity for each calculation channel. They are entered in the unit of measurement of the physical quantity selected for the calculation channel.

`Parameters\...\Calculation type\+Upper limit`

- Select `No limit` if the calculation channel has to output all positive values without upper limit.
- Press ENTER.
- Select `Set to limit` if the calculation channel has to output the limit when exceeding the upper limit.
- Press ENTER.
- Select `Set to error` if the calculation channel has to output an error (`UNDEF`) when exceeding the upper limit.
- Press ENTER.

Parameters\...\Calculation type\~Upper limit

- Select `No limit` if the calculation channel has to output all negative values without upper limit
- Press ENTER.
- Select `Set to limit` if the calculation channel has to output the limit when falling below the upper limit.
- Press ENTER.
- Select `Set to error` if the calculation channel has to output an error (`UNDEF`) when falling below the upper limit.
- Press ENTER.

It is possible to define 2 cut-off flows for each calculation channel. They are entered in the unit of measurement of the physical quantity selected for the calculation channel.

Parameters\...\Calculation type\+Cut-off flow

- Enter a value for the positive cut-off flow.
 - Press ENTER.
- All positive calculated values below the limit are set to zero.

Parameters\...\Calculation type\~Cut-off flow

- Enter a value for the negative cut-off flow as absolute value.
 - Press ENTER.
- All negative calculated values (as absolute value) below the limit are set to zero.

13.3.9.3 Measurement with calculation channels

- Select the menu `Installation`.
- Press ENTER.

Installation\Select channels

- Activate the necessary channels. Calculation channels are activated or deactivated the same way as measuring channels.
- Press ENTER.

Notice!

If a measuring channel that is needed for an activated calculation channel is deactivated, no value is output for the calculation channel.

13.3.9.4 Extended diagnostics

The extended diagnostic serves to detect errors on individual measuring channels. The values of the extended diagnostics can either be transmitted via the outputs of the transmitter or defined as source of the event triggers.

Assignment of an output

- Select the menu `Outputs`.
- Press ENTER.

Outputs\Current I1 (-)

- Select the output to be assigned to the calculation channel (here: `Current I1 (-)`).
- Press ENTER.

The scroll list contains all available outputs of the transmitter.

If the output has already been assigned to a channel, it is displayed as follows: `Current I1 (Y)`.

```
Outputs\Current I1\I1 Enable
```

- Select `Yes` to change the settings for an already assigned output or to assign a new output.
- Select `No` to cancel the assignment and to return to the previous menu item.
- Press `ENTER`.

Selection of the calculation channel

```
Outputs\Channel Y
```

- Select the calculation channel (here: `Channel Y`).
- Press `ENTER`.

Assignment of a source item

A source item has to be assigned to each selected output.

```
Outputs\Channel Y\...\Source item
```

- Select `Extended diagnostics` as source item.
- Press `ENTER`.
- Select a list item for the quantity to be output.
- Press `ENTER`.

Tab. 13.5: Source item `Extended diagnostics`

source item	list item	output
Extended diagnostics	Valid channels	percentage of physical channels, with valid measuring state
	Δ (Sound speed)	path difference of the sound speed
	Δ (Flow velocity)	path difference of the flow velocity
	Δ (Gain)	path difference of the signal gain
	Δ (Amplitude)	path difference of the signal amplitude
	Δ (Quality)	path difference of the signal quality
	Δ (SNR)	path difference of SNR
	Δ (SCNR)	path difference of SCNR
	Δ (VariAmp)	path difference of the amplitude variation
Δ (VariTime)	path difference of the transit time variation	

The list item `Valid channels` will not be displayed if a binary output was selected as output.

The status of a path difference is OK if a measured value for calculation is available on at least 2 measuring channels.

Definition of an event trigger

```
Functions\Channel Y
```

- Select a calculation channel in the menu `Functions`, for which an event trigger is to be enabled (here: `Channel Y`).
- Press `ENTER`.
- Select the menu item `Event trigger`.
- Press `ENTER`.

```
Functions\Channel Y\Event trigger\Rx(-)
```

- Select the event trigger.

If the event trigger has already been enabled, it is displayed as follows: `R1(+)`.

```
Functions\Channel Y\Event trigger\Rx Enable
```

- Select `Yes` to change the settings for an already assigned event trigger or to assign a new one.
- Select `No` to cancel the assignment and to return to the previous menu item.
- Press `ENTER`.

```
Functions\Channel Y\Event trigger\Rx Enable\Source item
```

- Select the source item `Extended diagnostics`.
- Press `ENTER`.
- Select the list item for which a condition is to be defined.
- Press `ENTER`.

14 Outputs

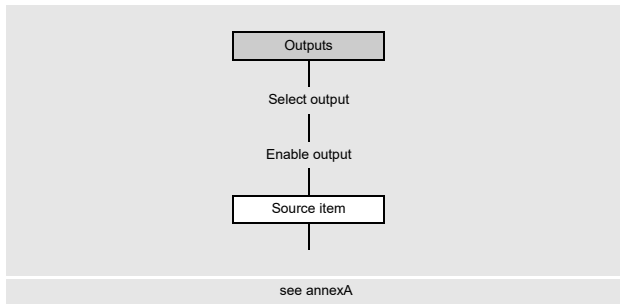

If the transmitter is equipped with outputs, they have to be configured. For the configuration of the analog output, see section 9.2.

The transmitter can also be equipped with digital outputs. A digital output combines the functions of the following outputs:

- binary output (output of binary switching conditions)
- pulse output (integrating output of quantities)
- frequency output (scaled output of flow quantities)

These functions depend on the selected physical quantity.

Tab. 14.1: Output via digital outputs

	source item	binary output		pulse output	frequency output
		status value	event value		
physical quantities	Sound speed	x			x
	Flow quantities	x			x
	Totalizers	x			x
	Pulse			x	
	Fluid properties	x			x
	Diagnostic values				x
	Miscellaneous	x			x
events	Event trigger		x		

14.1 Configuration of a digital output as binary output

A binary output switches if one of the following switching conditions is met:

- the measured value exceeds or falls below a limit
- the measured value lays within or outside a defined range
- a measurement is not possible
- an event occurs

Enabling the output

If the output has to be used, it has to be enabled.

```
Outputs\Digital output B1(-)
```

- Select the menu item `Outputs\Digital output B1(-)`.
- Press ENTER.

If the output has already been enabled, it is displayed as follows: `Digital output B1 (√)`.

```
Outputs\Digital output B1\B1 Enable
```

- Select `Yes` to enable the output or to change the settings.
- Select `No` to cancel the enabling and to return to the previous menu item.
- Press ENTER.

Assignment of an output

Outputs\Digital output B1\B1 Enable>Select meas. point

- Select the measuring point.
- Press ENTER.

This display will only be indicated if 2 meas. points (A|B) is selected for the configuration of the measuring point.

Assignment of a source item

A source item has to be assigned to each selected output.

Outputs\Source item

Tab. 14.2: Output of status values or event values

	source item	status value	event value
physical quantities	Flow quantities	x	
	Fluid properties	x	
	Miscellaneous	x	
	Sound speed	x	
	Totalizers	x	
events	Event trigger		x

- Select the source item.
- Press ENTER.
- Select the list item Status.
- Press ENTER.

If Event trigger is selected as source item, Idle state will be displayed as property of the binary output.

14.1.1 Definition of the switching function for the status/event value

- Select the switching function for the output of the status/event value.
- Press ENTER.

Tab. 14.3: Selection of the switching condition

property	switching function	description
Status OK (status value)	NC	<ul style="list-style-type: none"> • valid measured value: binary output is closed • invalid measured value: binary output is open
	NO	<ul style="list-style-type: none"> • valid measured value: binary output is open • invalid measured value: binary output is closed
Idle state (event value)	NO	<ul style="list-style-type: none"> • event occurs: binary output is closed • event has not occurred yet: binary output is open
	NC	<ul style="list-style-type: none"> • event occurs: binary output is open • event has not occurred yet: binary output is closed

If no measurement is carried out, all binary outputs are open (de-energized), independent of the set switching condition.

Terminal assignment

```
Outputs\Digital output B1\...\Output info
```

The terminals for the connection of the output are displayed.

By pressing or further information is displayed.

- Press ENTER.

Output function test

The function of the output can now be tested.

- Connect a multimeter to the output.

```
Outputs\...\B1 Test signal
```

- Select **Yes** to test the output. Select **No** to display the next menu item.
- Press ENTER.

```
Outputs\...\B1 Enter test value
```

- Select a list item as test value.
- Press ENTER.

Tab. 14.4: Output function test – signal

list item	description
NC	<ul style="list-style-type: none"> • binary output is energized • measured value has to be low ohmic
NO	<ul style="list-style-type: none"> • binary output is de-energized • measured value has to be high ohmic

- Select **Repeat** to repeat the test or **Finish** to display the next menu item.
- Press ENTER.

```
Outputs\...\B1 Test measuring range
```

- Select **Yes** to test the status of the output signal. Select **No** to display the next menu item.
- Press ENTER.

```
Outputs\...\B1 Enter test value
```

- Select a list item as test value.
- Press ENTER.

Tab. 14.5: Output function test – measuring range

list item	switching function	test value	description
Status OK (status value)	NC	Status OK	<ul style="list-style-type: none"> binary output is energized measured value has to be low ohmic
		Status error	<ul style="list-style-type: none"> binary output is de-energized measured value has to be high ohmic
	NO	Status OK	<ul style="list-style-type: none"> binary output is de-energized measured value has to be high ohmic
		Status error	<ul style="list-style-type: none"> binary output is energized measured value has to be low ohmic
Idle state (event value)	NC	Passive	<ul style="list-style-type: none"> binary output is energized measured value has to be low ohmic
		Active	<ul style="list-style-type: none"> binary output is de-energized measured value has to be high ohmic
	NO	Passive	<ul style="list-style-type: none"> binary output is de-energized measured value has to be high ohmic
		Active	<ul style="list-style-type: none"> binary output is energized measured value has to be low ohmic

- Select `Repeat` to repeat the test or `Finish` to display the next menu item.
- Press `ENTER`.

14.2 Configuration of a digital output as pulse output

A pulse output is an integrating output which emits a pulse when the volume or the mass of the fluid which has passed the measuring point reaches a certain value (pulse value).

The integrated quantity is the selected physical quantity. The integration is restarted as soon as the pulse is emitted. Before the activation, the digital output has to be configured.

```
Outputs\Digital output B1\Source item
```

- Select the menu item `Outputs\Digital output B1\Source item`.
- Press `ENTER`.

Assignment of a source item

```
Outputs\Source item\Pulse
```

- Select `Pulse` as source item.
- Press `ENTER`.

```
Outputs\Pulse\Pulse +V
```

- Select a list item (here: `Pulse +V`).
- Press `ENTER`.

Tab. 14.6: Selection of the physical quantity

source item	list item	output
Pulse	Pulse V	pulse without considering the sign of the volumetric flow rate
	Pulse +V	pulse for positive measured values of the volumetric flow rate
	Pulse -V	pulse for negative measured values of the volumetric flow rate
	Pulse m	pulse without considering the sign of the mass flow rate
	Pulse +m	pulse for the positive measured values of the mass flow rate
	Pulse -m	pulse for the negative measured values of the mas flow rate

14.2.1 Pulse output by defining the pulse value

Outputs\Pulse output

- Select the list item `Pulse value`.
- Press ENTER.

The pulse output can be operated in 2 modes:

mode	description
Continuous pulses	<ul style="list-style-type: none"> • output of a continuous pulse sequence, reproducing the temporal behavior of the corresponding flow quantity (volumetric flow rate, mass flow rate), at simultaneous totalizing • smallest pulse break = pulse width at max. pulse rate (pulse width is constant)
Burst pulses	<ul style="list-style-type: none"> • output of a discontinuous pulse sequence, reproducing the behavior of the totalizer • several pulses can arise intermittently with equidistant pulse distances (pulse break = pulse width) • serves exclusively for totalizing • max. pulse rate (depends on the pulse width that is constant)

- Select a list item.
- Press ENTER.

Outputs\Pulse value

- Enter the pulse value.

The unit of measurement will be displayed according to the actual physical quantity.

When the counted physical quantity reaches the entered pulse value, a pulse will be transmitted.

- Press ENTER.

Outputs\Pulse width

- Enter the pulse width.

The range of possible pulse widths depends on the specification of the instrument (e.g., counter, PLC) that is to be connected to the output.

- Press ENTER.

14.2.2 Pulse output by defining pulses per unit

Outputs\Pulse output

- Select the list item `Pulses per unit`.
- Press ENTER.

Outputs\Output range

- Select a list item:
 - 0...1 kHz
 - 0...5 kHz
 - Other range

- Press ENTER.

If `Other range` is selected, enter a value for `Output MAX`.

Outputs\Pulses per unit

- Enter the number of pulses per unit.
- Press ENTER.

The unit of measurement will be displayed according to the actual physical quantity.

14.2.3 Output options

Outputs\Idle state

- Select the setting of the idle state:

setting	description
NO	The pulse output is energized if a pulse is emitted and de-energized if no pulse is emitted (idle state).
NC	The pulse output is de-energized if a pulse is emitted and energized if no pulse is emitted (idle state).

If no measurement is carried out, all pulse outputs are open (de-energized), independent of the set switching condition.

Terminal assignment

Outputs\...\Output info

The terminals for the connection of the output are displayed.

By pressing 2 or 8 further information is displayed.

- Press ENTER.

Output function test

Outputs\...\B1 Test signal

- Select **Yes** to test the status of the output signal. Select **No** to display the next menu item.
- Press **ENTER**.

Outputs\...\B1 Enter test value

- Select a list item as test value.
- Press **ENTER**.

Tab. 14.7: Output function test – signal

output mode	test value	description
Pulses per unit	The entered test value has to be within the output range.	If the external measuring instrument displays the entered value, the output functions correctly.
Pulse value	NO	<ul style="list-style-type: none"> • pulse output is de-energized • measured value has to be high ohmic
	NC	<ul style="list-style-type: none"> • pulse output is energized • measured value has to be low ohmic

14.3 Configuration of a digital output as frequency output

The frequency output emits a square wave signal with a frequency which is proportional to the source item sent to the output.

Outputs\Digital output B1\Source item

- Select the menu item **Outputs\Digital output B1\Source item**.
- Press **ENTER**.

Assignment of a source item

- Select one of the following source items:
 - Flow quantities
 - Totalizers
 - Fluid properties
 - Diagnostic values
 - Miscellaneous
 - Sound speed

Outputs\Flow quantities

- Select a list item (here: **Flow quantities**).
- Press **ENTER**.

Outputs\Volumetric flow rate

- Select a list item (here: **Volumetric flow rate**).
- Press **ENTER**.
- Select the list item **Values**.
- Press **ENTER**.

Output range

```
Outputs\...\Output range
```

• Select a list item.

- 0...1 kHz
- 0...10 kHz
- Other range

• Press ENTER.

If `Other range` is selected, enter the values `Output MIN` and `Output MAX`.

Error output

```
Outputs\...\Error value
```

An error value can be defined which is output if the source item cannot be measured.

- Select a list item for the error output.
- Press ENTER.

Measuring range

The sign of the measured value and the measuring range are determined.

```
Outputs\...\Measured values\Absolute value
```

- Select `Sign` if the sign of the measured values is to be considered for the output.
- Select `Absolute value` if the sign of the measured values is not to be considered for the output.

```
Outputs\...\Start of meas. range
```

- Enter the lowest expected measured value. The unit of measurement of the source item will be displayed.
- `Start of meas. range` is the value assigned to the value `Output MIN` of the output range.

```
Outputs\...\End of meas. range
```

- Enter the highest expected measured value. The unit of measurement of the source item will be displayed.
- `End of meas. range` is the value assigned to the value `Output MAX` of the output range.

Idle state

The idle state is the status of the output signal to be output when no measured value is measured.

- Select a list item for the idle state.
- Press ENTER.

Terminal assignment

```
Outputs\...\Output info
```

The terminals for the connection of the output are displayed.

By pressing 2 or 8 further information is displayed.

- Press ENTER.

Output function test

The function of the output can now be tested.

- Connect an external measuring instrument to the terminals of the installed output.

```
Outputs\...\Test signal
```

- Select **Yes** to test the output. Select **No** to display the next menu item.
- Press **ENTER**.

```
Outputs\...\Enter test value
```

- Enter a test value. It has to be within the output range.
- Press **ENTER**.

If the external measuring instrument displays the entered value, the output functions correctly.

- Select **Repeat** to repeat the test or **Finish** to display the next menu item.
- Press **ENTER**.

```
Outputs\...\Test measuring range
```

- Select **Yes** to test the assignment of the measured value to the output signal. Select **No** to display the next menu item.
- Press **ENTER**.

```
Outputs\...\Enter test value
```

- Enter a test value. It has to be within the output range.
- Press **ENTER**.

If the external measuring instrument displays the entered value, the output functions correctly.

- Select **Repeat** to repeat the test and **Finish** to finish it.
- Press **ENTER**.

15 Inputs

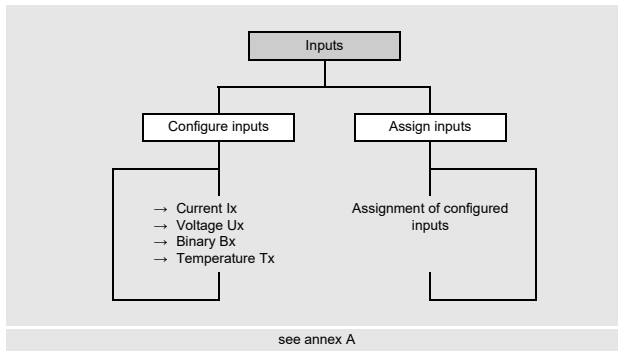

15.1 Configuration of an input

If the transmitter is equipped with inputs, they have to be configured.

- Select the menu item `Configure inputs` in the menu `Inputs`.
- Press ENTER.

```
Inputs\Configure inputs
```

- Select the input to be configured.
- Press ENTER.

The scroll list contains all available inputs.

- Current Ix (-)
- Voltage Ux (-)
- Binary Bx (-)
- Temperature Tx (-)

If the input has already been configured, it is displayed as follows: `Current I1 (✓)`.

Enabling the input

To use the input, it has to be enabled (here: `Current I1`).

```
Inputs\Configure inputs\Current I1\I1 Enable
```

- Select `Yes` to enable an input or change the settings for an already enabled input.
- Select `No` to uninstall an already configured input and to return to the previous menu item.
- Press ENTER.

15.1.1 Current and voltage inputs

When configuring the current or voltage inputs, the source item can now be selected and the input and measuring range is defined.

Selection of the source item

Inputs\...\Source item

- Select the source item.

Input range

Inputs\...\Input range

- Select a list item:

- 0...20 mA
- 4...20 mA
- Other range

- Press ENTER.

If `Other range` is selected, enter the values `Input MIN` and `Input MAX`.

Measuring range

Inputs\...\Start of meas. range

- Enter the lowest expected measured value. The unit of measurement of the source item will be displayed. `Start of meas. range` is the physical quantity assigned to the lower limit of the input range (`Input MIN`).
- Enter the highest expected measured value. The unit of measurement of the source item will be displayed. `End of meas. range` is the physical quantity assigned to the higher limit of the input range (`Input MAX`).

Input of an error value

Inputs\...\Error value

It is possible to define an error value which is output if the source item is not available.

- Select `Yes` if an error value is to be defined.
- Press ENTER.
- Enter the error value.
- Press ENTER.

15.1.2 Temperature inputs

When configuring a temperature input, the temperature probe can now be selected.

Selection of the temperature probe

```
Inputs\Configure inputs\Temperature Tx\Pt100/Pt1000
```

• Select the temperature probe:

- Pt100
- Pt1000

Activation of the temperature correction

A temperature correction (offset) can be set for each temperature input. This function is activated in the menu item `Miscellaneous\Dialogs/Menus\Tx temperature offset`.

```
Miscellaneous\Dialogs/Menus\Tx temperature offset
```

- Select the menu item `Miscellaneous\Dialogs/Menus`.
- Press ENTER until the menu item `Tx temperature offset` is displayed.
- Select `Yes` to activate the temperature correction. Select `No` to deactivate it.
- Press ENTER.

Notice!

The entered correction value for each temperature input will be stored and displayed when the temperature correction is activated again.

The correction value is automatically added to the measured temperature. It is used e.g., if the characteristic curves of the two temperature probes differ considerably from each other or a known and constant temperature gradient exists between the measured temperature and the actual temperature.

Input of the temperature correction

```
Inputs\Temperature offset
```

- Select `Yes` to enter an offset for the temperature input.
- Press ENTER.
- Enter the offset for the temperature input.
- Press ENTER.

15.1.3 Definition of a switching condition

If a transmitter function is to be performed by remote control, a switching condition has to be defined.

Inputs\...\Trigger value

- Select **Yes** if a switching condition is to be defined. Select **No** to display the next menu item.
- Press **ENTER**.

Inputs\...\Function

- Select a list item:
 - **MAX (x>limit)**: the switching condition is met when the measured value exceeds the limit
 - **MIN (x<limit)**: the switching condition is met when the measured value falls below the limit
 - **ERR (x=fail)**: the switching condition is met when a measurement is not possible
 - **Within range**: the switching condition is met when the measured value is within the defined range
 - **Out of range**: the switching condition is met when the measured value is outside the defined range
- Press **ENTER**.

Inputs\...\Trigger value

- Enter the limit for the switching condition.
 - Press **ENTER**.
- This display will only be indicated if **MAX (x>limit)** or **MIN (x<limit)** is selected.

Inputs\...\Hysteresis

It is possible to define a hysteresis to avoid constant switching of the event trigger.
The event trigger is activated when the measured value exceeds the upper limit and deactivated when it falls below the lower limit.

- Enter the value for the hysteresis.
- If zero is entered, no hysteresis is used.
- Press **ENTER**.
- This display will only be indicated if **MAX (x>limit)** or **MIN (x<limit)** is selected.

Inputs\...\Range center

- Enter the center of the switching range.
 - Press **ENTER**.
- This display will only be indicated if **Within range** or **Out of range** is selected.

Inputs\...\Range width

- Enter the width of the switching range.
 - Press **ENTER**.
- This display will only be indicated if **Within range** or **Out of range** is selected.

Inputs\...\Glitch interval

- Enter a time interval at the end of which the event trigger has to switch.
- Press **ENTER**.

15.1.4 Binary inputs

The transmitter can be equipped with max. 4 binary inputs. Via the binary inputs, it is possible to remotely trigger some functions of the transmitter.

Inversion of the input

```
Inputs\Configure inputs\Binary Bx\Negate input
```

- Select **Yes** if a function is to be triggered when no voltage is existing (negated logic).
- Select **No** if a function is to be triggered when voltage is existing.

15.1.5 Terminal assignment

```
Inputs\...\Input info
```

The terminals for the connection of the input are displayed.

By pressing or further information is displayed.

- Press **ENTER**.

15.1.6 Function test of the input

The function of the installed input can now be tested.

Analog input

- Connect the signal source to the input.

```
Inputs\...\I1 Test signal
```

- Select **Yes** to test the input signal. Select **No** to display the next menu item.
- Press **ENTER**.

```
Inputs\...\I1 Test signal\Current
```

- If the transmitter displays a value (here: **Current**), the input functions correctly.
- Press **ENTER**.
- Select **Repeat** to repeat the test or **Finish** to display the next menu item.
- Press **ENTER**.

```
Inputs\...\I1 Test measuring range
```

- Select **Yes** to test the assignment of the measured value to the input signal. Select **No** to display the next menu item.
- Press **ENTER**.

```
Inputs\...\I1 Test measuring range\Current
```

- If the transmitter displays a value (here: **Current**), the input functions correctly.
- Press **ENTER**.
- Select **Repeat** to repeat the test or **Finish** to display the next menu item.
- Press **ENTER**.

Binary input

- Connect the signal source to the input.

```
Inputs\...\I1 Test signal
```

- Select **Yes** to test the input signal. Select **No** to display the next menu item.
- Press **ENTER**.

If the transmitter displays that a input signal is connected, the input functions correctly.

- Press  to return to the main menu.

15.2 Assignment of an input

- Select the menu item **Assign inputs** in the menu **Inputs**.
- Press **ENTER**.

```
Inputs\Assign inputs
```

- Select a physical quantity in the scroll list.
- Press **ENTER**.
- Select the input via which the physical quantity is to be entered. Only configured inputs are displayed in the scroll list.
- Select the list item **No linkage** if no input is to be assigned to the physical quantity.
- Press **ENTER**.

16 Data logger

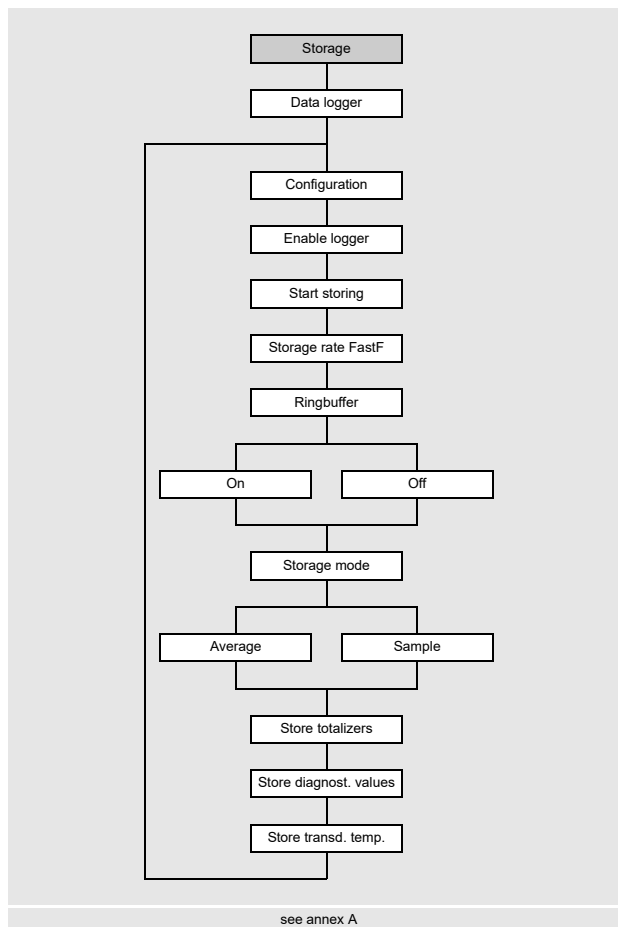

The transmitter has a data logger which stores the measured values during the measurement.

Notice!

In order to store measured data, the data logger has to be configured.

The following data can be stored:

- date
- time
- measuring point number
- pipe parameters
- fluid parameters
- transducer data
- physical quantity
- unit of measurement
- measured values

Measured values transmitted via the outputs are also stored in the data logger.

If the pulse values are transmitted via an output, the corresponding flow quantity and the totalizer value are stored in the data logger. In case of absolute pulse values, the values of both totalizers are stored.

16.1 Configuration of the data logger

Enabling the data logger

```
Storage\Data logger\Configuration\Enable logger
```

- Select the menu item `Data logger\Configuration` in the menu `Storage`.
- Press ENTER.
- Select `Yes` to enable the data logger.
- Press ENTER.

Starting time

```
Storage\Data logger\Configuration\Start storing
```

It is possible to set a starting time if it is necessary to synchronize the storing of measured values for several transmitters.

- Select the menu item `Storage\Data logger\Configuration`.
- Press ENTER until the menu item `Start storing` is displayed.
- Select the moment at which to start the storing.
- Press ENTER.

display	description
Immediately	The storing starts immediately.
Full 5 minutes	The storing starts in the next full 5 minutes.
Full 10 minutes	The storing starts in the next full 10 minutes.
Full 15 minutes	The storing starts in the next full 15 minutes.
Full 30 minutes	The storing starts in the next full 30 minutes.
Full hour	The storing starts in the next full 60 minutes.
Event-based	The storing starts when a defined event occurs.

Example

actual time: 09:06 am
 setting: Full 10 minutes
 The storing starts at 09:10 am.

Notice!

Make sure that the time of all transmitters is synchronized.

Event-based starting time

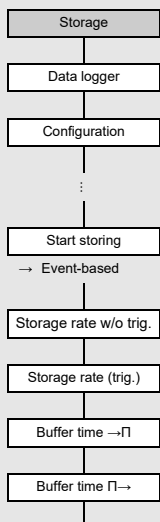

see annex A

```
Storage\Data logger\Configuration\
Start storing\Event-based
```

If it is necessary to start the storing of measured values at a particular event, select the list item *Event-based* as starting time.

The event is signaled via an input or event trigger. All configured inputs and event triggers are displayed in the scroll list.

- Select the input or the event trigger through which the event is to be signaled.
- Press ENTER.

```
Storage\Data logger\Configuration\Start storing\Event-based\Storage rate w/o trig.
```

The storage rate is the frequency to transmit or store measured values.

- Select in the scroll list a storage rate for storing the measured values in case the event does not occur.
- Press ENTER.
- Select *Off* if no measured values are to be stored, as long as the event does not occur.
- Press ENTER.

```
Storage\Data logger\Configuration\Start storing\Event-based\Storage rate (trig.)
```

- Select in the scroll list a storage rate for storing the measured values in case the event occurs.
- Press ENTER.

```
Storage\Data logger\Configuration\Start storing\Event-based\Buffer time ->Π
```

- Enter the time interval for the measured values to be stored before the event occurs.
- Press ENTER.

```
Storage\Data logger\Configuration\Start storing\Event-based\Buffer time Π->
```

- Enter the time interval for the measured values to be stored if the event is no longer activated.
- Press ENTER.

Storage rate

```
Storage\Data logger\Configuration\Storage rate
```

The storage rate is the frequency to transmit or store measured values. If a start time for storing the measured values is defined, a storage rate has to be entered.

- Select the menu item `Storage\Data logger\Configuration`.
- Press ENTER until the menu item `Storage rate` is displayed.
- Select a storage rate from the scroll list.
- Press ENTER.
- If `Customized` is selected, enter the storage rate.
- Press ENTER.

Storage rate of the FastFood mode

The the storage rate of the FastFood mode is the frequency at which the measured values are stored in the FastFood mode.

```
Storage\Data logger\Configuration\Storage rate FastF
```

This display will only be indicated if the FastFood mode has been activated in the menu item `Miscellaneous\Measurement\Measurement modes`.

- Select the menu item `Storage\Data logger\Configuration`.
- Press ENTER until the menu item `Storage rate FastF` is displayed.
- Select `Automatic` if the storage rate has to correspond to the value of the FastFood measuring rate.
- Press ENTER.
- Select `Customized` if the value for the storage rate is to be defined.
- Press ENTER.
- Enter a value.
- Press ENTER.

Ringbuffer

Storage\Data logger\Configuration\Ringbuffer

The data logger can be configured as linear logger or ringbuffer. If the ringbuffer is deactivated and the data logger is full, the storing of measured values will be terminated. It can be continued after clearing the data logger. If the ringbuffer is activated and the data logger is full, the oldest measured values will be overwritten. In ringbuffer mode, the remaining capacity of the data logger is displayed during the measurement, e.g.:

Log→ : 1d 6h 57m is displayed, if no measured values have been overwritten.

Log|←| : 1d 6h 57m is displayed, if the old measured values have been overwritten.

- Select the menu item `Storage\Data logger\Configuration`.
- Press ENTER until the menu item `Ringbuffer` is displayed.
- Select `On` to activate the ringbuffer.
- Press ENTER.

If the ringbuffer is deactivated and the data logger is full, the storing of measured values will be terminated.

- Select `Off` to deactivate the ringbuffer.
- Press ENTER.

Storage mode

Storage\Data logger\Configuration\Storage mode

- Select the menu item `Storage\Data logger\Configuration`.
- Press ENTER until the menu item `Storage mode` is displayed.
- Press ENTER.
- Select `Sample` to store the current measured value.
- Select `Average` if the average of all undamped measured values of a storage interval is to be stored.

Notice!

The storage mode does not affect the outputs.

Notice!

Storage mode = Average

The average of the physical quantity and of other quantities, e.g., the measured temperature, will be calculated.

If a storage rate < 5 s is selected, `Sample` is used.

If no average could be calculated over the complete storage interval, the value is marked as invalid.

Further parameters for storing

It can be defined whether the following parameters are to be stored together with the measured values.

Tab. 16.1: Parameters for storing

display	description of the parameters
Store totalizers	values of the totalizers
Store diagnost. values	diagnostic values
Store transd. temp.	transducer temperature

- Select `Yes` to store the value. Select `No` in order not to store the value.

16.2 Deletion of the data logger

Storage\Data logger>Delete meas. values

- Select the menu item Storage\Data logger>Delete meas. values.
- Press ENTER.
- Select Yes to delete the measured values.
- Press ENTER.

16.3 Information regarding the data logger

Storage\Data logger\Data logger info

- Select the menu item Storage\Data logger\Data logger info.
- Press ENTER.

The following information regarding the data logger is displayed:

display	description
Activated	data logger is activated/deactivated This display will only be indicated if the measurement has started and the data logger is activated.
Full (date)	date on which the data logger will be full This display will only be indicated if the measurement has started and the ringbuffer is deactivated.
Full (time)	time at which the data logger will be full This display will only be indicated if the measurement has started, the ringbuffer is deactivated and the data logger is not full yet.
Overflow (date)	date from which the oldest measured values will be overwritten This display will only be indicated if the measurement has started, the ringbuffer is activated and the data logger is not full yet.
Capacity (time)	time of remaining data logger capacity This display will only be indicated if the measurement has started and the ringbuffer is activated.
Ringbuffer	ringbuffer is activated/deactivated
Meas. val. Series	number of stored series of measured values

17 Data transmission

The data is transmit via the service interfaces or the process interface (optional) of the transmitter.

17.1 Service interfaces

By means of the program FluxDiagReader it is possible to transmit via service interfaces (USB, LAN) data to the PC.

The following tasks can be carried out:

- read and store measured values, setup settings and snaps
- graphically display measured values
- export of data in csv format

For the operation of FluxDiagReader see the help function of this program.

17.1.1 LAN interface

In order to use the LAN interface it is important to adapt the network parameters. The transmitter supports the internet protocol versions 4 and 6.

Communication\Network

- Select the list item `Network` in the menu item `Communication`.
- Press ENTER.

17.1.1.1 Internet protocol version 6

The transmitter uses the automatic address configuration (SLAAC) to generate 2 individual IPv6 addresses allowing it to be reached in the network.

- link-local address with the prefix "FE80::/64"
With this address, the transmitter can only be reached within its own network segment.
- global address
With this address, the transmitter can be reached worldwide.
- Select the list item `IPv6` to display these IPv6 addresses.
- Press ENTER.

The IPv6 addresses are displayed.

17.1.1.2 Internet protocol version 4

- If the network parameters for IPv4 are to be adjusted, select the list item `IPv4`.
- Press ENTER.

Manual input

- Select `Manual` to enter the network parameters (IP address, subnet mask and standard gateway).

Notice!

The entered network parameters have to accord with the LAN parameters.

Default values in the transmitter:

- IP address: 192.168.0.70
- subnet mask: 255.255.255.0
- standard gateway: 192.168.0.1

Automatic addressing with DHCP

- Select `Automatic` to automatically identify the network parameters (IP address, subnet mask and standard gateway) via a DHCP server.

Notice!

The network parameters can only be automatically identified if the LAN supports DHCP.

- Select the menu item `Communication\Network\IPv4>Show auto config.` to display the automatically identified network parameters.
- Press ENTER.

Notice!

To transmit data from the PC to the transmitter, the program FluxDiag has to be used.

17.2 Process interface

The transmitter can be equipped with a process interface (e.g., Profibus, Modbus). For the connection of the process interface to the transmitter see supplement to operating instruction.

RS485 interface

```
Communication\RS485
```

- Select the menu item `RS485` to change the settings of the transmission parameters.
- Press ENTER.

This display will only be indicated if the transmitter has an interface RS485.

default: 9600 bit/s, 8 data bits, no parity, 1 stop bit

- Set the transmission parameters in the scroll lists.
 - Baud (baud rate)
 - Data bits
 - Stop bits
 - Parity
 - Data flow control
- Press ENTER.

```
Communication\Info RS485
```

The terminals for the connection of the RS485 interface are displayed.

- Press ENTER.

18 Advanced functions







18.1 Totalizers

The thermal energy, total volume or total mass of the fluid at the measuring point can be determined.

There are 2 totalizers, one for the positive and the other for the negative flow direction. The unit of measurement used for totalizing corresponds to the heat, volume or mass unit selected for the physical quantity.

The totalizer values can be displayed in the status line during the measurement.

Tab. 18.1: Key functions

totalizer display	press  once during the measurement
freezing of the displayed totalizer value	press  for at least 2 s during the measurement
display of the totalizer for the positive flow direction	press  once during the measurement
display of the totalizer for the negative flow direction	press  once during the measurement
reset of the totalizers to zero	press  3 times during the measurement totalizing will be restarted after pressing the key 
	press  3 times during the measurement totalizing will be restarted and displayed immediately

Notice!

If `Channel-based param.` is selected in the menu `Parameters` to configure the measuring point, a keystroke will only influence the totalizers of the measuring channel whose measured values are currently displayed.

18.1.1 Number of decimal places

The values of the totalizers can be displayed with up to 11 places, e.g., 74890046.03. The number of decimal places (max. 4) can be defined.

Storage\Totalizers

- Select the menu item `Totalizers` in the menu `Storage`.
- Press `ENTER`.
- Select `Automatic` if the number of decimal places has to be adjusted automatically.
- Press `ENTER`.

Low totalizer values will initially be displayed with 3 decimal places. If the values of the totalizers are higher, the number of decimal places will be reduced.

max. value	display
$< 10^6$	±0.000 ... ±999999.999
$< 10^7$	±1000000.00 ... ±9999999.99
$< 10^8$	±10000000.0 ... ±99999999.9
$< 10^{10}$	±1000000000 ... ±9999999999

- Select the number of decimal places.
- Press `ENTER`.

The number of decimal places is constant. The max. value of the totalizers decreases with an increasing number of decimal places.

decimal places	max. value	max. display
0	$< 10^{10}$	±999999999
1	$< 10^8$	±99999999.9
2	$< 10^7$	±9999999.99
3	$< 10^6$	±999999.999
4	$< 10^5$	±99999.9999

Notice!

The number of decimal places and the max. value of the totalizers only affect the display.

18.1.2 Detection of long measurement failures

If there are no valid measured values during a long time interval, the totalizers remain unchanged. Behind this value an interrogation point will be displayed.

The time interval can be defined.

```
Storage\Totalizers\Totalizer timeout
```

- Select the menu item `Totalizers` in the menu `Storage`.
- Press ENTER until the menu item `Totalizer timeout` is displayed.
- Select `Default` if no customized inputs are to be carried out and the default value of 30 s is to be used.
- Press ENTER.
- Select `Customized` if the time interval is to be defined.
- Press ENTER.
- Enter the time interval.
- Press ENTER.

18.1.3 Totalizer overflow

The overflow behavior of the totalizers can be set:

Without overflow

- The totalizer value increases up to the internal limit of 10^{38} .
- The values will be displayed as exponential numbers ($\pm 1.00000E10$), if necessary. The totalizer can only be reset to zero manually.

With overflow

The totalizer will be automatically reset to zero when reaching ± 999999999 .

```
Storage\Totalizers\Overflow behavior
```

- Select the menu item `Totalizers` in the menu `Storage`.
- Press ENTER until the menu item `Overflow behavior` is displayed.
- Select `Yes` to work with overflow. Select `No` to work without overflow.
- Press ENTER.

Independent of the setting, the totalizers can be reset to zero manually.

Notice!

The overflow of a totalizer influences all output channels, e.g., the data logger and the online transmission of data.
The sum of both totalizers (throughput ΣQ) transmitted via an output is no longer valid after one of the totalizers has overflowed for the first time.

18.1.4 Totalizer behavior after the measurement is stopped

It is possible to define the totalizer behavior after the measurement is stopped or after a reset of the transmitter.

```
Storage\Totalizers\Keep totalizers
```

- Select the menu item `Totalizers` in the menu `Storage`.
- Press ENTER until the menu item `Keep totalizers` is displayed.
- Select `Yes` if the values of the totalizers are to be stored and used for the next measurement. Select `No` if the totalizers are to be set to zero.
- Press ENTER.

18.1.5 Totalizer behavior during thermal energy rate measurement

During the thermal energy rate measurement, it is possible to output and store the values the thermal energy totalizer and of the volume totalizer.

```
Storage\Totalizers\Therm.ener.+flow tot.
```

- Select the menu item `Totalizers` in the menu `Storage`.
- Press ENTER until the menu item `Therm.ener.+flow tot.` is displayed.
- Select `Yes` if the values of the thermal energy totalizer and the volume totalizer are to be stored and output during the thermal energy measurement.
- Press ENTER.

18.1.6 Totalizer sum

The sum of the totalizers for both flow directions can be displayed in the status line during the measurement.

```
Storage\Totalizers\Show  $\Sigma Q$ 
```

- Select the menu item `Totalizers` in the menu `Storage`.
- Press ENTER until the menu item `Show ΣQ` is displayed.
- Select `Yes` to display the totalizer sum. Select `No` if it is not to be displayed.
- Press ENTER.

18.1.7 Totalizer storing

The totalizer values can be stored now.

```
Storage\Data logger\Configuration
```

- Select the menu item `Storage\Data logger\Configuration`.
- Press ENTER until the menu item `Store totalizers` is displayed.
- Select `Yes`.
- Press ENTER.

18.2 FastFood mode

The FastFood mode allows to measure highly dynamic flows. A continuous adaptation to changing measuring conditions is only partially realized in the FastFood mode.

- The measured values are stored with the storage rate of the FastFood mode.
- The FastFood mode has to be enabled and activated.
- The outputs can still be used. They are updated synchronously with the FastFood measuring rate, independently from the storage rate.

If 2 meas. points (A|B) is selected in the menu item `Parameters` for the configuration of the measuring point, the following points have to be observed:

- It is not possible to change the measuring channel. The measurement takes place on one channel only. As long as the FastFood mode is activated, no measurement is carried out on the other measuring channels.
- The outputs of the measuring channel activated in FastFood mode can still be used. They are updated synchronously with the FastFood measuring rate, independently from the storage rate.
- Outputs for further measuring channels (multi-channel measurement) transmit an error value.

FLUXUS *721:

- The sound speed of the fluid is not updated. The last measured value of the sound speed before toggling to the FastFood mode is used.

FLUXUS *722:

If the synchronized channel averaging is activated in the menu item `Miscellaneous\Measurement\Measurement modes\Synch. chan. averag.`, this function will not be available.

18.2.1 Enabling/disabling the FastFood mode

```
Miscellaneous\Measurement\Measurement modes\Enable FastFood
```

- Select the menu item `Miscellaneous\Measurement\Measurement modes`.
- Press ENTER until the menu item `Enable FastFood` is displayed.
- Select `On` to enable the FastFood mode. Select `Off` to disable it.
- Press ENTER.

If `On` is selected, the menu item `Measuring rate FastF` is displayed. The FastFood measuring rate indicates in which interval measured values are transmitted to the process outputs.

- Select `Default` if no customized inputs are to be made (default: 50 ms).
- Select `Customized` if a value for the FastFood measuring rate is to be entered.
- Enter a value within the range 20...200 ms.
- Press ENTER.

18.2.2 Storage rate of the FastFood mode

The storage rate for the FastFood mode is entered during the configuration of the data logger in the menu item `Storage rate FastF`.

```
Storage\Data logger\Configuration\Storage rate FastF
```

- Select the menu item `Storage\Data logger\Configuration`.
- Press ENTER until the menu item `Storage rate FastF` is displayed.
- Select `Automatic` if the storage rate has to correspond to the value of the FastFood measuring rate.
- Press ENTER.
- Select `Customized` if the value for the storage rate is to be defined.
- Press ENTER.
- Enter a value.
- Press ENTER.

18.2.3 Activation/deactivation of the FastFood mode

If the FastFood mode is enabled and a measurement has been started, the normal measuring mode runs at first.

- Press to activate the FastFood mode. The symbol for the FastFood mode  appears in the upper line.
- Press to deactivate the FastFood mode.

The FastFood mode can also be activated/deactivated via a remote function.

18.3 Diagnosis with the help of the snap function

18.3.1 Configuration

By means of the snap function it is possible to store measuring parameters which are useful for the evaluation of measuring results or for diagnostic purposes. The snap function can be configured.

```
Storage\Snap\Configuration
```

- Select the menu item `Snap\Configuration` in the menu `Storage`.
- Press ENTER.

```
Storage\Snap\Configuration\Snap ringbuffer
```

- Select `Yes` to activate the snap ringbuffer.

If the snap ringbuffer is activated, after taking the 51th snap, the oldest snaps are overwritten. If the ringbuffer is deactivated, up to 50 snaps can be stored.

- Press ENTER.

```
Storage\Snap\Configuration\Auto snap
```

- Select `Yes` if the auto snap has to be activated.

If the auto snap is activated, snaps are automatically stored during a measurement failure.

- Press ENTER.

```
Storage\Snap\Configuration\Snap on R1
```

- Select `Yes` if an event that releases a snap has been parameterized for the event trigger R1.
- Press ENTER.

18.3.2 Taking a snap

```
Measurement\Execute command\Take a snap
```

- Press and hold `C` during the measurement until the menu item `Execute command` is displayed.
- Select the list item `Take a snap`.
- Press ENTER.

A snap is taken.

18.3.3 Information concerning snaps

Storage\Snap\Snap info

- Select the menu item Snap\Snap info in the menu Storage.
- Press ENTER.

The following information is displayed:

display	description
Stored snaps	number of stored snaps
Snaps left	number of snaps that can still be stored
Ringbuffer	snap ringbuffer activated

18.3.4 Deletion of snaps

Storage\Snap>Delete snaps

- Select the menu item Snap>Delete snaps in the menu Storage.
- Press ENTER.
- Select Yes or No.
- Press ENTER.

18.4 Modification of the limit for the inner pipe diameter

It is possible to modify the lower limit of the inner pipe diameter for a given transducer type.

Miscellaneous\Pipe diameter MIN

- Select the menu item Pipe diameter MIN in the menu Miscellaneous.
 - Press ENTER.
- It is possible to define a min. pipe diameter for all relevant transducer frequencies.
- Select Default if no customized inputs are to be made and the default values are to be used.
 - Press ENTER.
 - Select Customized if a min. pipe diameter is to be defined.
 - Press ENTER.
 - Enter the pipe diameter in mm.
 - Press ENTER.

Notice!

If a transducer is used below its recommended inner pipe diameter, a measurement might be impossible.

18.5 Remote functions

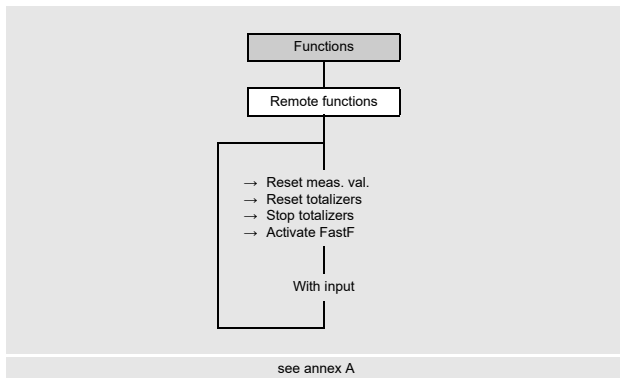

Remote functions can be triggered by triggerable analog inputs or event triggers.

In order to define an input for a remote function, it has to be enabled in the menu `Inputs`.

In order to define an event trigger for a remote function, it has to be enabled in the menu item `Functions\ Event trigger`.

It is possible to trigger one or more of the following remote functions:

- reset of measured values
- reset of totalizers
- stop of totalizers
- activation of the FastFood mode

Triggerable inputs and event triggers

The remote function is triggered if the switching condition is met. The remote function is reset as soon as the switching condition is not longer met.

18.5.1 Configuration of the remote function

`Functions\Remote functions`

- Select the menu item `Remote functions` in the menu `Functions`.
- Press ENTER.

In the scroll list of the functions it is displayed whether, and if so, which input or event trigger is assigned to a function.

- Select a list item:
 - `Reset meas. val. (-)`
 - `Reset totalizers (-)`
 - `Stop totalizers (-)`
 - `Activate FastF(-)`

If an input or event trigger has already been assigned to this function, this is displayed as follows:

`Reset meas. val. (R1).`

- Press  to return to the previous menu.

Reset of measured values

- Select the list item `Reset meas. val.`
- Press ENTER.

The measured value output simulates a reposing application for the duration of the signal. The actual measured flow velocity is ignored and the measured value is set to zero. All values of the physical quantity derived from the flow velocity also yield zero.

The transmitter continues the measurement if the condition of the remote function is no longer met.

- Select the input which is to be used to trigger the selected remote function.
- Press ENTER.
- Select `No linkage` in order to deactivate the remote function.
- Press ENTER.

Reset of totalizers

- Select the list item `Reset totalizers`.
- Press ENTER.

The totalizers are set to zero. The totalizers are deactivated for the duration of the signal.

Totalizing starts at zero again, as soon as the condition for the remote function is no longer met.

When the totalizers are reset to zero with the remote function, the character `H` is displayed next to the measured value during the measurement.

- Select the input which is to be used to trigger the selected remote function.
- Press ENTER.
- Select `No linkage` in order to deactivate the remote function.
- Press ENTER.

Stop of totalizers

- Select the list item `Stop totalizers`.
- Press ENTER.

The totalizers are stopped for the duration of the signal.

Totalizing will be continued with the last registered totalizer value if the condition of the remote function is no longer met.

- Select the input which is to be used to trigger the selected remote function.
- Press ENTER.
- Select `No linkage` in order to deactivate the remote function.
- Press ENTER.

Activation of the FastFood mode

- Select the list item `Activate FastF`.
- Press ENTER.

The FastFood mode is activated for the duration of the signal. It is deactivated as soon as the condition for the remote function is no longer met.

This list item only appears if the FastFood mode is enabled in the menu item `Miscellaneous\Measurement\Measurement modes\FastFood` and `1 meas. point (A)` or `2 meas. points (A|B)` are selected for the configuration of the measuring point.

- Select the input which is to be used to trigger the selected remote function.
- Press ENTER.
- Select `No linkage` in order to deactivate the remote function.
- Press ENTER.

18.6 Event triggers

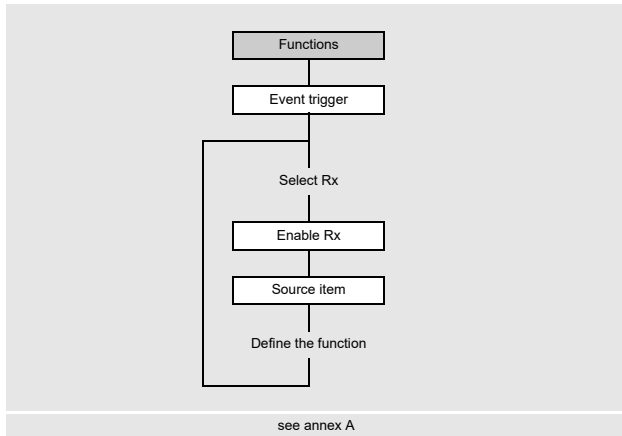

It is possible to configure max. 4 independent event trigger R1, R2, R3, R4.

The event triggers can be used, e.g., to:

- output information about the running measurement
- trigger special remote functions
- switch on/off pumps and motors

Functions\Event trigger

- Select the menu item `Event trigger` in the menu `Functions`.
- Press `ENTER`.

Functions\Event trigger\Rx(-)

- Select an event trigger.
- Press `ENTER`.

If an event trigger has already been installed, it is displayed as follows: `Rx (√)`.

Functions\Event trigger\Rx Enable

- Select `Yes` to change the settings for an already assigned event trigger or to assign a new one.
- Select `No` to cancel the assignment and to return to the previous menu item.
- Press `ENTER`.

Functions\Event trigger\Rx Enable\Source item

- Select the source item (physical quantity) for which a condition has to be defined.

Tab. 18.2: Source items

source item	list item	output
Flow quantities	Flow velocity	flow velocity
	Volumetric flow rate	volumetric flow rate
	Mass flow rate	mass flow rate
	Thermal energy rate ⁽¹⁾	thermal energy rate

⁽¹⁾ only if `Thermal energy rate` is selected as physical quantity in the menu `Parameters`

Tab. 18.2: Source items

source item	list item	output
Totalizers	Volume (+)	totalizer for the volumetric flow rate in positive flow direction
	Volume (-)	totalizer for the volumetric flow rate in negative flow direction
	Volume (Δ)	difference of the totalizers for the positive and negative flow direction
	Mass (+)	totalizer for the mass flow rate in positive flow direction
	Mass (-)	totalizer for the mass flow rate in negative flow direction
	Mass (Δ)	difference of the totalizers for the positive and negative flow direction
	Thermal energy (+) ⁽¹⁾	thermal energy totalizer for positive measured values of the thermal energy rate
	Thermal energy (-) ⁽¹⁾	thermal energy totalizer for negative measured values of the thermal energy rate
	Thermal energy (Δ) ⁽¹⁾	difference of the thermal energy totalizer
Fluid properties	Fluid temp.	fluid temperature
	Supply temperature ⁽¹⁾	supply temperature (thermal energy rate measurement)
	Return temperature ⁽¹⁾	return temperature (thermal energy rate measurement)
	Temperature (Δ) ⁽¹⁾	difference between supply and return temperature (thermal energy rate measurement)
	Fluid pressure	fluid pressure
	Supply pressure ⁽¹⁾	supply pressure (thermal energy rate measurement)
	Return pressure ⁽¹⁾	return pressure (thermal energy rate measurement)
	Pressure (Δ) ⁽¹⁾	difference between supply and return pressure (thermal energy rate measurement)
	Fluid density	fluid density
	Kin. viscosity	kinematic viscosity
	Dyn. viscosity	dynamic viscosity
Diagnostic values	Amplitude	signal amplitude
	Quality	signal quality
	SNR	signal-to-noise ratio
	SCNR	signal-to-correlated noise ratio
	VariAmp	amplitude variation
	VariTime	transit time variation
	Gain	gain required to receive a useful signal
	Pig detection	signals whether a pig is detected This display will only be indicated if Pig detection is activated.
Miscellaneous	Custom. Input 1	measured values of input quantities (e.g., temperature, density) which are not used for calculation In the menu item Inputs\Assign inputs it is possible to assign configured inputs to customized inputs.
	Custom. Input 2	
	Custom. Input 3	
	Custom. Input 4	

⁽¹⁾ only if Thermal energy rate is selected as physical quantity in the menu Parameters

Tab. 18.2: Source items

source item	list item	output
Sound speed	Sound speed	measured sound speed in the fluid
	Sound speed (Δ)	difference of the measured sound speed and the sound speed calculated from the fluid data

(1) only if `Thermal energy rate` is selected as physical quantity in the menu `Parameters`

Afterwards the properties of the event trigger are defined.

Tab. 18.3: Properties of the event trigger

property	setting	description
Function (switching condition)	MAX ($x > \text{limit}$)	The event trigger switches when the measured value exceeds the upper limit.
	MIN ($x < \text{limit}$)	The event trigger switches when the measured value falls below the lower limit.
	ERR ($x = \text{fail}$)	The event trigger switches when a measurement is not possible.
	Within range	The event trigger switches when the measured value is within the defined range.
	Out of range	The event trigger switches when the measured value is outside the defined range.
Type (holding behavior)	Non-hold	When the switching condition is no longer met, the event trigger returns to the idle state after approx. 1 s.
	Hold	The event trigger remains activated even when the switching condition is no longer met.
	Hold for a while	The event trigger remains activated during a defined time even when the switching condition is no longer met.

Definition of the switching condition

```
Functions\Event trigger\Rx Enable\Source item\...\Function
```

- Select the switching condition.
- Press ENTER.

Definition of the holding behavior

```
Functions\Event trigger\Rx Enable\Source item\...\Type
```

- Select the type of the holding behavior.
- Press ENTER.

Definition of trigger limits

```
Functions\Event trigger\Rx Enable\Source item\...\Trigger value
```

The limits are to be entered at which the event trigger has to switch.

- Enter the upper limit `MAX ($x > \text{limit}$)`.
- Press ENTER.
- Enter the lower limit `MIN ($x < \text{limit}$)`.
- Press ENTER.

```
Functions\Event trigger\Rx Enable\Source item\...\Hysteresis
```

It is possible to define a hysteresis to avoid constant switching of the event trigger.

The event trigger is activated when the measured values exceed the upper limit. It is deactivated when the measured values fall below the lower limit.

- Enter the value for the hysteresis.

If zero is entered, no hysteresis is used.

- Press ENTER.

Example

```
MAX (x>limit): 30 m3/h
```

```
Hysteresis: 1 m3/h
```

The event trigger is activated for measured values > 30.5 m³/h and deactivated for measured values < 29.5 m³/h.

```
Functions\Event trigger\Rx Enable\Source item\...\Range center
```

- Enter the center of the range in which the event trigger has to be switched.

- Press ENTER.

```
Functions\Event trigger\Rx Enable\Source item\...\Range width
```

- Enter the width of the range in which the event trigger has to be switched.

- Press ENTER.

Example

```
Function: Out of range
```

```
Range center: 100 m3/h
```

```
Range width: 40 m3/h
```

The event trigger will switch if the measured value is below 80 m³/h or above 120 m³/h.

Definition of the switching delay

```
Functions\Event trigger\Rx Enable\Source item\...\Glitch interval
```

- Enter a time interval after which the event trigger has to switch in case the event occurred.

- Press ENTER.

```
Functions\Event trigger\Rx Enable\Source item\...\Failure delay
```

- Enter a time interval after which the event trigger has to be deactivated in case of a measurement failure.

- Press ENTER.

18.6.1 Apparent switching delay

The measured values and totalizer values will be displayed rounded according to the set number of decimal places. The limits, however, will be compared to the non-rounded measured values. This might cause an apparent switching delay when the measured value changes marginally (less than the visualized decimal places). In this case, the switching accuracy of the event trigger is higher than the accuracy of the display.

18.6.2 Reset and initialization of the event triggers

After an initialization of the transmitter all event triggers are deactivated.

- Press 3 times C during measurement to set all event triggers to the idle state.

Event triggers whose switching condition is still met will be activated again after 1 s. This function is used to reset event triggers of the type HOLD if the switching condition is no longer met.

If a measurement is stopped, all event triggers will be deactivated and the corresponding process outputs will be de-energized, independently of the programmed idle state.

18.6.3 Event trigger during the measurement

An event trigger with the switching condition MAX ($x > \text{limit}$), MIN ($x < \text{limit}$), Within range or Out of range is updated max. once per second to avoid a constant switching of the event trigger (in case the measured values fluctuate around the value of the switching condition).

An event trigger with switching condition ERR ($x = \text{fail}$) is activated during a measurement failure.

An event trigger of the type Non-hold is activated when the switching condition is met. It is deactivated when the switching condition is no longer met. But it remains activated for at least 1 s even when the switching condition is met for a shorter period of time.

An event trigger of the type Hold is activated when the switching condition is met. It remains activated even when the switching condition is no longer met.

An event trigger of the type Hold for a while is activated when the switching condition is met. The time after which the deactivation takes place is defined in the menu item Hold interval.

18.6.4 Status display of the event triggers

Notice!

There is no visual or acoustic indication of event trigger switching.











The state of the event triggers is displayed during the measurement.

- Press 9 to scroll through the second line from below until the event trigger status is displayed.

The status display of the event triggers is structured as follows.

Rx = with x being the number of the event trigger and a pictogram according to Tab. 18.4.

Tab. 18.4: Pictograms for the status display of the event triggers

	no.		Function (switching condition)	Type (holding behavior)	current state
R	<input type="text"/>	=	<input type="text"/>	<input type="text"/>	<input type="text"/>
	1		 MAX ($x > \text{limit}$)	 Non-hold	 deactivated (false state)
	2		 MIN ($x < \text{limit}$)	 Hold	 activated (true state)
	3		 Within range	 Hold for a while	
	4		 Out of range		
			 ERR ($x = \text{fail}$)		

Example

R1 =   

18.7 Event log

If an error occurs, an error message will be displayed in the first line indicating the symbol . The error message can be displayed.

Storage\Event log

- Select the menu item `Event log` in the menu `Storage`.
- Press ENTER.

A list is displayed containing all error messages since the last time the transmitter was switched on.

- Press `8` and `2` to select an error message.
- Press ENTER.

The display indicates the cause of the error.

Notice!

After reading out the event protocol the error message symbol will be deleted on the display, even if the error has not been eliminated yet.

The event protocol will be deleted after a restart of the transmitter.

19 Settings

19.1 Dialogs and menus

Miscellaneous\Dialogs/Menu

- Select the menu item Dialogs/Menu in the menu Miscellaneous.
- Press ENTER.

Pipe circumference

Miscellaneous\Dialogs/Menu\Pipe circumference

- Press ENTER until the menu item Pipe circumference is displayed.
- Select Yes if the pipe circumference is to be entered instead of the pipe diameter in the menu Parameters.
- Press ENTER.

If Yes is selected for Pipe circumference, the outer pipe diameter will still be requested in the menu Parameters.

- Press to select the menu item Pipe circumference.
- Press ENTER.

The value displayed in the menu item Pipe circumference is calculated from the last displayed outer pipe diameter.

Example: $100 \text{ mm} \cdot \pi = 314.2 \text{ mm}$

- Enter the pipe circumference. The limits for the pipe circumference are calculated on the basis of the limits for the outer pipe diameter.
- Press ENTER.

During the next scroll through the menus Parameters, the outer pipe diameter that corresponds to the entered pipe circumference will be displayed.

Example: $180 \text{ mm} : \pi = 57.3 \text{ mm}$

Coating

If the pipe has a coating, the material parameters of the coating have to be entered in the menu Parameters.

Miscellaneous\Dialogs/Menu>Edit coating

- Press ENTER until the menu item Edit coating is displayed.
- Select Yes if the pipe has a coating.
- Press ENTER.

Lining 2

If the pipe has a second lining, the material parameters of the second lining have to be entered in the menu Parameters.

Miscellaneous\Dialogs/Menu>Edit Lining 2

- Press ENTER until the menu item Edit Lining 2 is displayed.
- Select Yes if the pipe has 2 linings.
- Press ENTER.

Measuring point number

Miscellaneous\Dialogs/Menu\Measuring point no.

- Press ENTER until the menu item Measuring point no. is displayed.
- Select Number if the measuring point number should only consist of numeric characters. Select Text if the measuring point number should only consist of alphabetic characters.
- Press ENTER.

Error delay

The error delay is the time after which an error value will be sent to an output if no valid measured values are available.

```
Miscellaneous\Dialogs/Menu/Error delay
```

- Press ENTER until the menu item `Error delay` is displayed.
- Select `Edit` to enter an error delay. Select `Damping` if the damping factor is to be used as the error delay.
- Press ENTER.

Temperature correction

```
Miscellaneous\Dialogs/Menu/Tx temperature offset
```

- Press ENTER until the menu item `Tx temperature offset` is displayed.
- Select `Yes` to enable the input of a temperature correction for each temperature input.
- Press ENTER.

Transducer distance

```
Miscellaneous\Dialogs/Menu/Transducer distance
```

- Press ENTER until the menu item `Transducer distance` is displayed.
- Select `Customized` if the measuring point is always the same. Select `Automatic` if the measuring point often changes.
- Press ENTER.

In the menu `Measurement`, the recommended transducer distance will be displayed in parenthesis, below the entered transducer distance.

Sound speed of the reference fluid

```
Miscellaneous\Dialogs/Menu/Compare c fluid
```

- Press ENTER until the menu item `Compare c fluid` is displayed.

Select `Yes` if the difference $\Delta c = c_{\text{mea}} - c_{\text{stored}}$ between the two sound speeds has to be displayed. c_{ref} is the calculated sound speed of the reference fluid at same process conditions (temperature, pressure).

- Press ENTER.

`Compare c fluid` can also be activated or deactivated during the measurement and has an immediate effect on the display of the measured values.

- Press during the measurement to scroll to the display of Δc .

Display of the last value

```
Miscellaneous\Dialogs/Menu/Display last value
```

- Press ENTER until the menu item `Display last value` is displayed.
- Select `Yes` to display the last valid value.
- Press ENTER.

If `Yes` is selected and no valid measured value can be displayed during the measurement, the last valid value will be displayed. Behind this value an interrogation point will be displayed.

Toggle time

If 1 meas. point (AB) or 2 meas. points (A|B) is selected for the configuration of the measuring point in the menu `Parameters`, the time interval can be defined, after which the transmitter toggles between the different measuring channels during the measurement. The default value is 3 s.

Miscellaneous\Dialogs\Menu\Toggle time

- Press ENTER until the menu item `Toggle time` is displayed.
- Enter a different toggle time value if the default value is no to be used.
- Press ENTER.

This value remains stored until a new toggle time is entered.

Primary display value

Miscellaneous\Dialogs\Menu\Primary display value

- Press ENTER until the menu item `Primary display value` is displayed.
- Select `Flow quantity` to display the selected physical quantity value as primary value during the measurement. Select `Totalizer` to display the totalizer value as primary value during the measurement.
- Press ENTER.

Switching off the display backlight

Miscellaneous\Dialogs\Menu\Light autom. off

- Press ENTER until the menu item `Light autom. off` is displayed.
- Select `Yes` to activate the automatic switch-off.
- Press ENTER.

If the automatic switch-off of the display backlight is activated, the backlight is switched off after about 30 s. When pressing a key or connecting a USB cable, the backlight is switched on again.

19.2 Measurement modes

Miscellaneous\Measurement\Measurement modes

- Select the menu item `Measurement` in the menu `Miscellaneous`.
- Press ENTER.
- Select the menu item `Measurement modes`.
- Press ENTER.

Synchronized channel averaging (FLUXUS *722)

Miscellaneous\Measurement\Measurement modes\Synch. chan. averag.

- Press ENTER until the menu item `Synch. chan. averag.` is displayed.
- Select `On` to activate the synchronized channel averaging. Select `Off` to deactivate it.
- Press ENTER.

FastFood mode

Miscellaneous\Measurement\Measurement modes\Enable FastFood

- Press ENTER until the menu item `Enable FastFood` is displayed.
- Select `On` to enable the FastFood mode. Select `Off` to disable it.
- Press ENTER.

If the synchronized channel averaging is activated, this display will not be indicated.

19.3 Measurement settings

Miscellaneous\Measurement\Measurement settings

- Select the menu item `Measurement` in the menu `Miscellaneous`.
- Press ENTER.
- Select the menu item `Measurement settings`.
- Press ENTER.

Multi-point calibration

A multi-point calibration allows a very precise output of measuring results. It is based on calibration curves of series of measured values

Miscellaneous\Measurement\Measurement settings\Multi-point calibration

- Press ENTER until the menu item `Multi-point calibration` is displayed.
- Select `On` to activate the multi-point calibration. Select `Off` to deactivate it (default: `Off`).
- Press ENTER.

If `On` is selected, a series of measured values has to be entered in the menu item `Calibration\Multi-point calibration`.

Swift damping

If `Swift damping` is activated, each displayed measured value is a floating average of the last `x` seconds, with `x` being the damping factor. The display thus requires `x` seconds to fully respond to flow rate changes.

If `Swift damping` is deactivated, the damping is calculated as first order low-pass filter, i.e. changes of measured values become effective in form of an exponential time course in the measuring result.

Miscellaneous\Measurement\Measurement settings\Swift damping

- Press ENTER until the menu item `Swift damping` is displayed.
- Select `Off` to deactivate the swift damping. Select `On` to activate it (default: `On`).
- Press ENTER.

Dynamic damping

If dynamic damping is activated, volatile changes in the measured values of the selected physical quantity are transmitted through the transmitter without any time lag.

Important!

The dynamic damping will only have impact on the selected physical quantity. All other physical quantities are not dynamically damped.

Miscellaneous\Measurement\Measurement settings\Dynamic damping

- Press ENTER until the menu item `Dynamic damping` is displayed.
- Select `On` to activate the dynamic damping. Select `Off` to deactivate it (default: `Off`).
- Press ENTER.

If `On` is selected, the dynamic damping has to be parameterized in the menu item `Parameters\Dynamic damping`.

19.4 Units of measurement

It is possible to set the global units of measurement for length, temperature, pressure, sound speed, density and kinematic viscosity.

Miscellaneous\Units of measurement

- Select the menu item `Units of measurement` in the menu `Miscellaneous`.
- Press ENTER.
- Select a unit of measurement for all quantities.
- Press ENTER.

Miscellaneous\Units of measurement\Barrel type

In this menu item it is possible to define which barrel type is to be displayed as unit of measurement for the volumetric flow rate.

- Press ENTER until the menu item `Barrel type` is displayed.
- Select a barrel type.
- Press ENTER.

19.5 Material and fluid scroll list

At delivery, all stored materials and fluids are displayed in the corresponding lists in the menu item `Parameters\Pipe material` or `Parameters\Fluid`.

For the sake of clarity, materials and fluids can be removed from the scroll list. Removed materials and fluids can be added at any time.

Adding or removing materials/fluids

Miscellaneous\Libraries\Use material list

- Select the menu item `Miscellaneous\Libraries\Use material list`.
- Press ENTER.
- Select `Yes` if a material is to be added to or removed from the material scroll list.
- Press ENTER.
- Press `8` or `2` to scroll through the scroll list.
- Press `6` or `4` to add (+) or remove (-) a material.
- Press ENTER.

Similarly, the fluid scroll list can be adapted (`Miscellaneous\Libraries\Use fluid list`).

Adding all materials/fluids

Miscellaneous\Libraries\Use material list

- Select the menu item `Miscellaneous\Libraries\Use material list`.
- Press ENTER.
- Select `No` if all materials are to be displayed in the material scroll list.
- Press ENTER.

Similarly, the fluid scroll list can be adapted (`Miscellaneous\Libraries\Use fluid list`).

19.6 Working with parameter records

19.6.1 Introduction

Parameter records are data sets that contain all information necessary to perform a certain measurement task:

- pipe parameters
- transducer parameters
- fluid parameters
- output options

Working with parameter records will make repeated measurement tasks easier and faster. The transmitter can store max. 20 parameter records.

Notice!

No parameter records are stored in the delivery state. Parameter records have to be entered manually.

The parameters have first to be entered in the following menus `Parameters` and `Miscellaneous`. Afterwards, they can be stored as parameter record.

```
Miscellaneous\Param. record memo.
```

- Select the menu item `Param. record memo.` in the menu `Miscellaneous`.
- Press ENTER.
- Select the menu item `Save current record.`
- Press ENTER.

```
Miscellaneous\Param. record name
```

- Enter the name the parameter record has to be stored with.
- Press ENTER.

19.6.2 Load of a parameter record

Stored parameter records can be loaded and used for measurement.

```
Miscellaneous\Param. record memo.\Load param. record
```

- Select the menu item `Load param. record.`
- Press ENTER.
- Select the parameter record to be loaded.
- Press ENTER.

19.6.3 Deletion of parameter records

```
Miscellaneous\Param. record memo.\Delete param. record
```

- Select the menu item `Delete param. record.`
- Press ENTER.
- Select the parameter record to be deleted.
- Press ENTER.

19.7 Contrast settings

Miscellaneous\System settings\Display contrast

- Select the menu item `System settings` in the menu `Miscellaneous`.
- Press ENTER.
- Select the menu item `Display contrast`.
- Press ENTER.

The display contrast is adjusted with the following keys:

`6` increases the contrast

`4` reduces the contrast

- Press ENTER.

Notice!

After an initialization of the transmitter, the display is reset to medium contrast.

19.8 HotCodes

A HotCode is a digit sequence that activates certain functions and settings.

- Press `↵` for several seconds to return to the beginning of the menu.
- Press C.
- Enter the HotCode via the keyboard. It is not displayed during the input.

function	HotCode
display setting to medium contrast	555000
language selection	9090xx
initialization	909000
activation/deactivation of the flow direction detection	007026
activation/deactivation of the pig detection	007028
display of totalizers in the lower line as well	007032

Language selection

The language selection can either be carried out via the menu `Miscellaneous\System settings\Language` or a `HotCode`:

language	HotCode
English	909044
German	909049
French	909033
Spanish	909034
Dutch	909031
Russian	909007
Polish	909048
Turkish	909090
Italian	909039
Chinese	909086

After the last digit has been entered, the main menu is displayed in the selected language. The selected language remains activated when the transmitter is switched off and on again.

19.9 Key lock

An ongoing measurement can be protected from an inadvertent intervention by means of a key lock.

Definition of a key lock code

- Select the menu item `System settings` in the menu `Miscellaneous`.
- Press ENTER.

`Miscellaneous\System settings\Key lock`

- Select the menu item `Key lock`.
- Press ENTER.
- Enter a 6-digit key lock code.
- Press ENTER.

Notice!

Do not forget the key lock code!

Deactivation of the key lock

`Miscellaneous\System settings\Key lock`

- Select the menu item `Miscellaneous` in the menu `System settings`.
- Press ENTER.
- Select the list item `Key lock`.
- Press ENTER.
- Enter a 6-digit key lock code.
- Press ENTER.

Intervention in the measurement

If the key lock is activated, the message `Key lock activated` will be displayed for a few seconds when pressing a key. In order to interrupt a measurement, the key lock has to be deactivated.

- Press .
- Select the menu item `System settings\Key lock` in the menu `Miscellaneous`.
- Press ENTER.
- Deactivate the key lock.

Disabled functions with activated key lock

The following table gives an overview of the transmitter functions that are not available when the key lock is activated.

measurement not started	measurement started
<ul style="list-style-type: none">• parameter input• modification of settings (e.g., measuring modes)• deletion of the data logger• setting of time/date• start of measurement (start-up)	<ul style="list-style-type: none">• modification of settings that are available in an ongoing measurement (e.g., language selection)• triggering snaps• toggling to FastFood mode• toggling to NoiseTrek mode• stop of the totalizers• reset of the totalizers• stop of the measurement

20 Thermal energy rate measurement (option)

If the transmitter has the optional thermal energy measurement and 2 temperature inputs, the thermal energy rate can be measured. A temperature probe is fixed on the supply and the return line.

The transducers are fixed on the return line. If this is not possible, they can also be mounted on the supply line.

Fig. 20.1: Thermal energy rate measurement with flow measurement

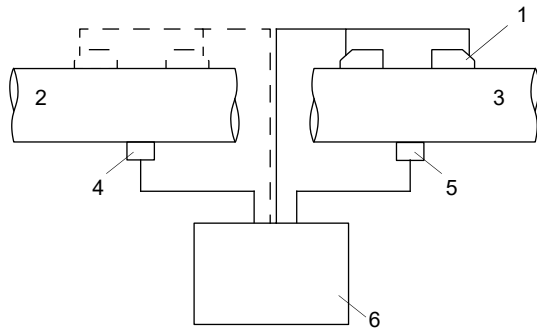

- 1 – transducer
- 2 – supply line
- 3 – return line
- 4 – temperature probe on supply line (temperature input T_V)
- 5 – temperature probe on return line (temperature input T_R)
- 6 – transmitter

Tab. 20.1: Possible measurement arrangements

heating application	$T_V > T_R$	transducers on supply line
		transducers on return line
cooling application	$T_V < T_R$	transducers on supply line
		transducers on return line

A temperature correction value (offset) can be set for each temperature input.

The thermal energy is the totalizer of the thermal energy rate.

20.1 Calculation of the thermal energy rate

The thermal energy rate is calculated with the following formula:

$$\Phi = k_i \cdot \dot{V} \cdot (T_V - T_R)$$

where

- Φ – thermal energy rate
- k_i – thermal coefficient
- \dot{V} – volumetric flow rate
- T_V – supply temperature
- T_R – return temperature

The thermal coefficient k_i is calculated from several thermal energy rate coefficients for the specific enthalpy and the density of the fluid. The thermal coefficients of some fluids are stored in the internal database of the transmitter.

If no thermal energy rate coefficients are available for the selected fluid, an error message will be displayed.

20.2 Definition of the physical quantity and the unit of measurement

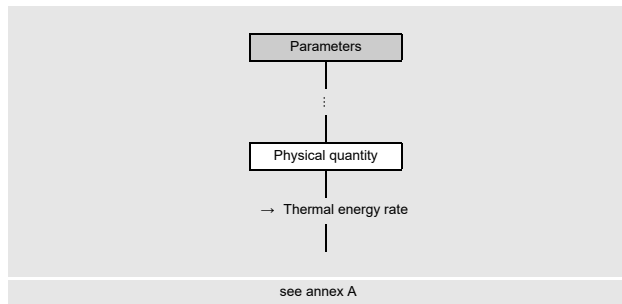

Parameters\...\Physical quantity

- Select the menu `Parameters`.
- Press `ENTER` until the menu item `Physical quantity` is displayed.
- Select the list item `Thermal energy rate`.
- Press `ENTER`.
- Select the unit of measurement to be used for the thermal energy rate.
- Press `ENTER`.

20.3 Application and transducer positioning

Parameters\...\Thermal energy rate\Application

- Select `Heating` if the system is to be operated as heating application.
- Press `ENTER`.
- Select `Cooling` if the system is to be operated as cooling application.
- Press `ENTER`.

Parameters\...\Thermal energy rate\Transducer location

- Select `Return line` if the measurement arrangement was configured for a thermal energy rate measurement on the return line.
- Press `ENTER`.
- Select `Supply line` if the measurement arrangement was configured for a thermal energy rate measurement on the supply line.
- Press `ENTER`.

Parameters\...\Thermal energy rate\Thermal energy rate

- Select `Sign` if the sign of the thermal energy rate is not to be considered.
- Press `ENTER`.
- Select `Absolute value` if the absolute value of the thermal energy rate is to be displayed.
- Press `ENTER`.

Parameters\...\Thermal energy rate\Phase transition

- Select `Yes` if the aggregate state of the fluid changes between the return and supply line. Select `No` if it does not change.
- Press `ENTER`.

This function is only available, if water, ammonia or a coolant is selected as fluid.

In the SuperUser mode it is possible to additionally enter a lower limit of the temperature difference.

Parameters\...\Thermal energy rate\Limit ΔT

- Select `Customized` to define a lower limit for the thermal energy rate measurement.
- Select `Default` if no customized inputs are to be made and the default values are to be used.
- Select `Off` if no lower limit for the thermal energy rate measurement is to be defined.
- Press `ENTER`.

20.4 Assignment of the temperature inputs

The supply and return temperature are assigned as `Supply temperature` and `Return temperature` respectively in the transmitter. The temperatures can be measured or entered as constant values.

The temperature inputs have to be enabled in the menu `Inputs`.

`Inputs\Assign inputs`

- Select the menu item `Assign inputs` in the menu `Inputs`.
- Press ENTER.
- Select the menu item `Supply temperature`.
- Press ENTER.
- Select the assignment to determine the supply temperature. Select `Fixed value` if the supply temperature is known and constant during the entire measuring time. The value is entered in the menu `Parameters`.
- Press ENTER.
- Select the menu item `Return temperature`.
- Press ENTER.
- Select the assignment to determine the return temperature. Select `Fixed value` if the supply temperature is known and constant during the entire measuring time. The value is entered in the menu `Parameters`.
- Press ENTER.

20.5 Two independent thermal energy rate measurements

If the transmitter has 2 measuring channels and 4 temperature inputs for each measuring channel, it is possible to conduct 2 independent thermal energy rate measurements at the same time.

Select `2 meas. points (A|B)` for the configuration of the measuring point in the menu `Parameters`.

Tab. 20.2: Configuration of the temperature inputs in case of 2 independent thermal energy rate measurements

		temperature input
measuring channel A	supply temperature	T1 or constant value
	return temperature	T2 or constant value
	measurement of thermal energy	possible
measuring channel B	supply temperature	T3 or constant value
	return temperature	T4 or constant value
	measurement of thermal energy	possible

Annex

A Menu structure

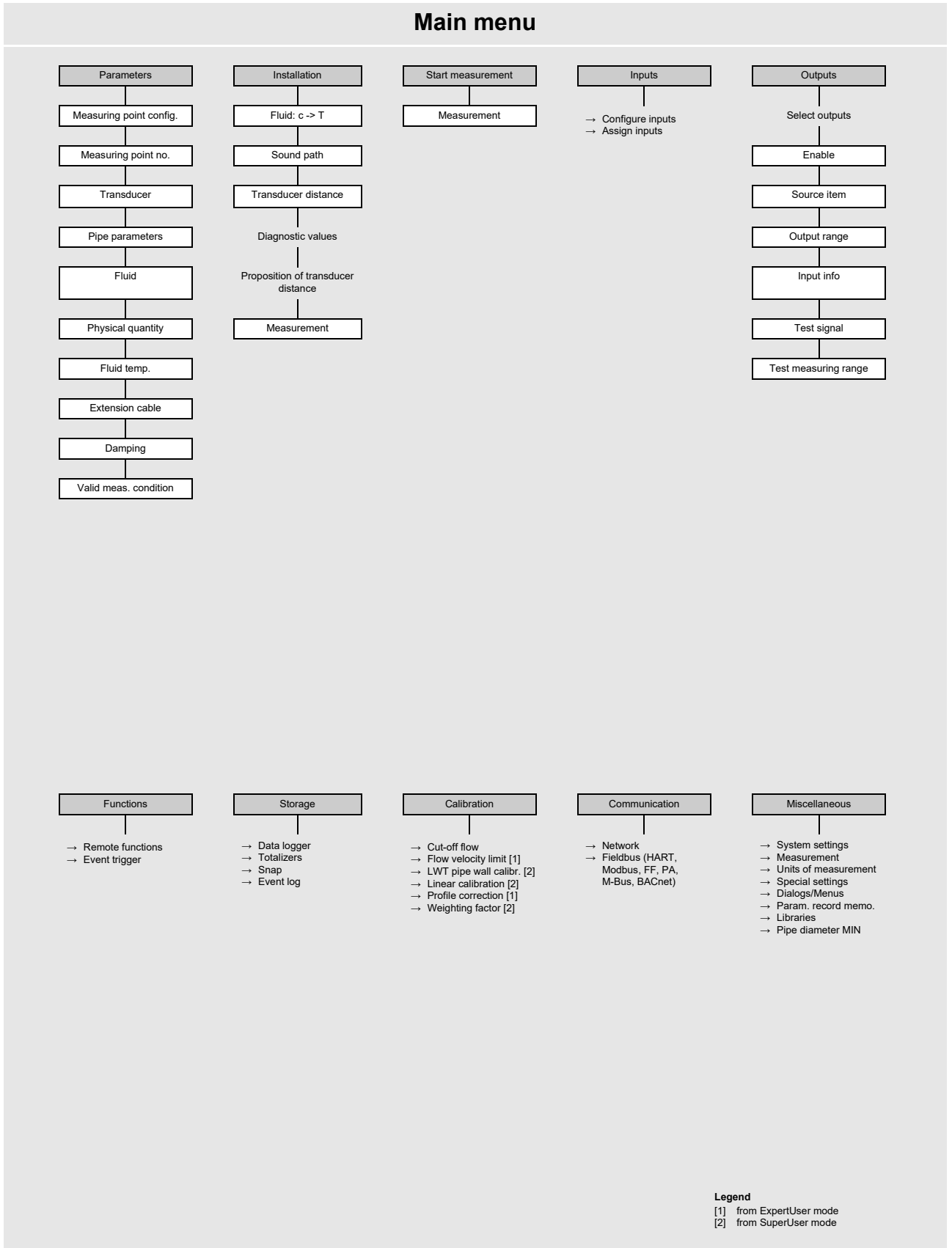

Parameter input

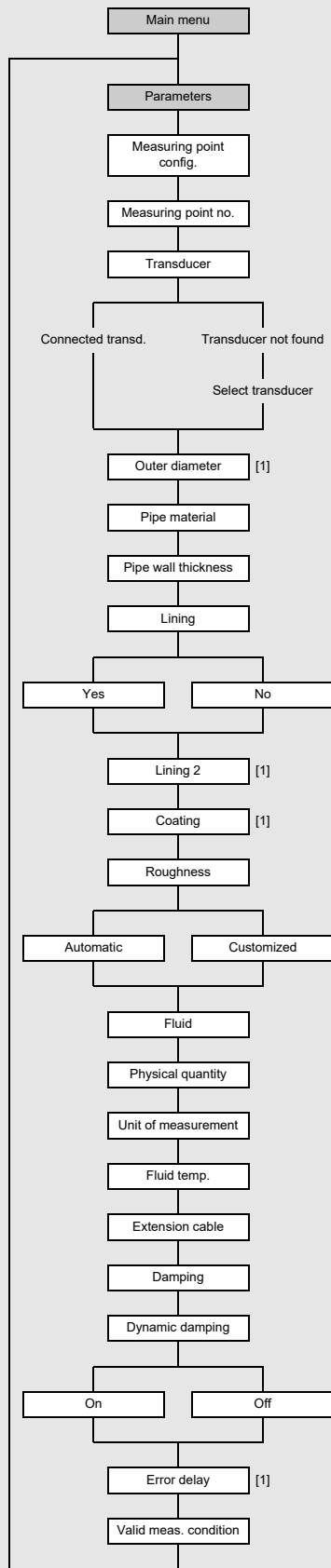

Legend

[1] only if enabled in the menu item Miscellaneous\Dialogs/Menus

Data logger

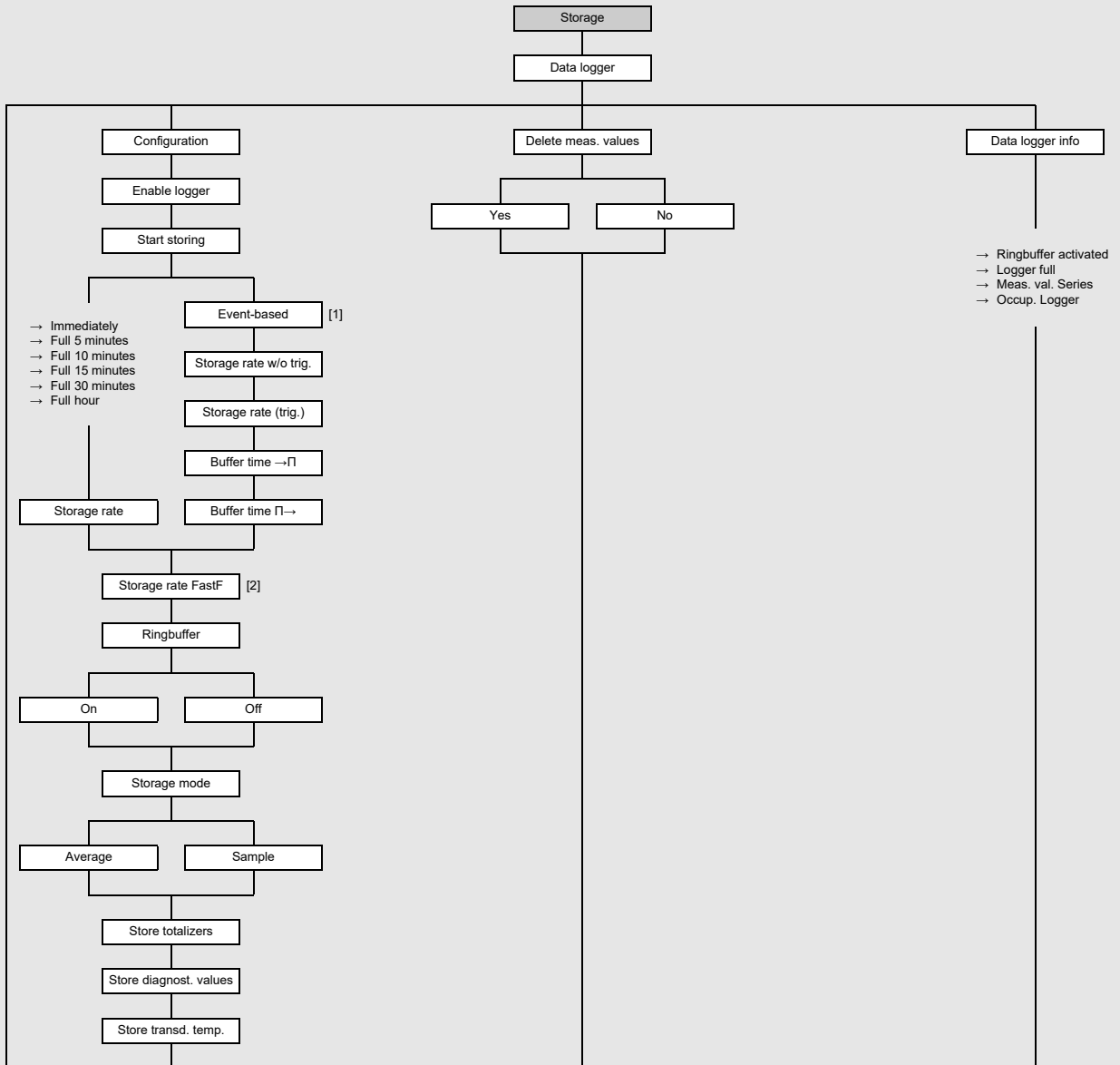

Measurement start

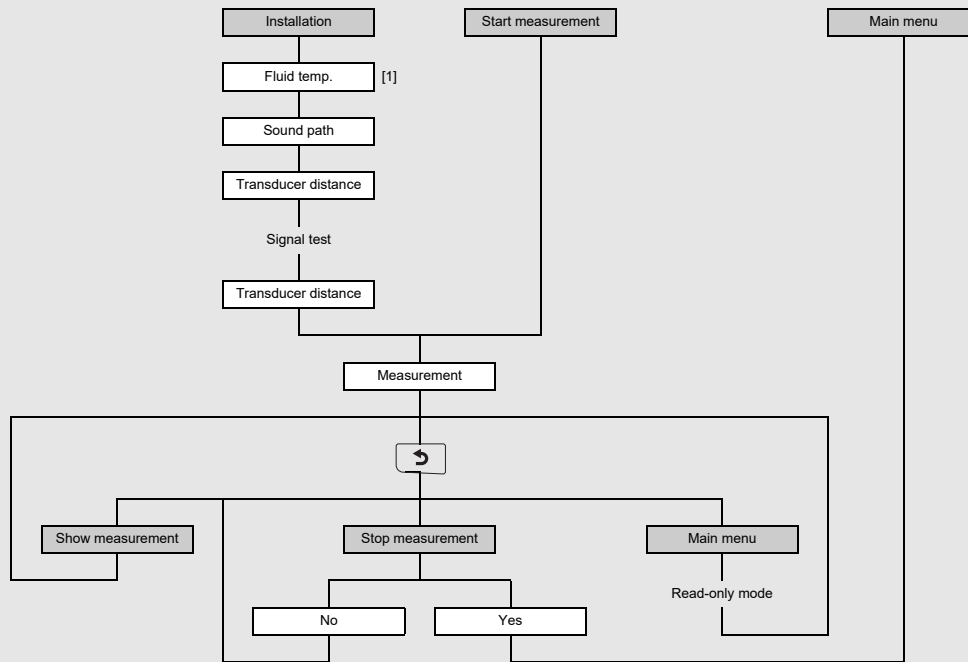

Legend
[1] only if enabled in the menu item Miscellaneous\Special settings\Fluid: c -> T

Output configuration

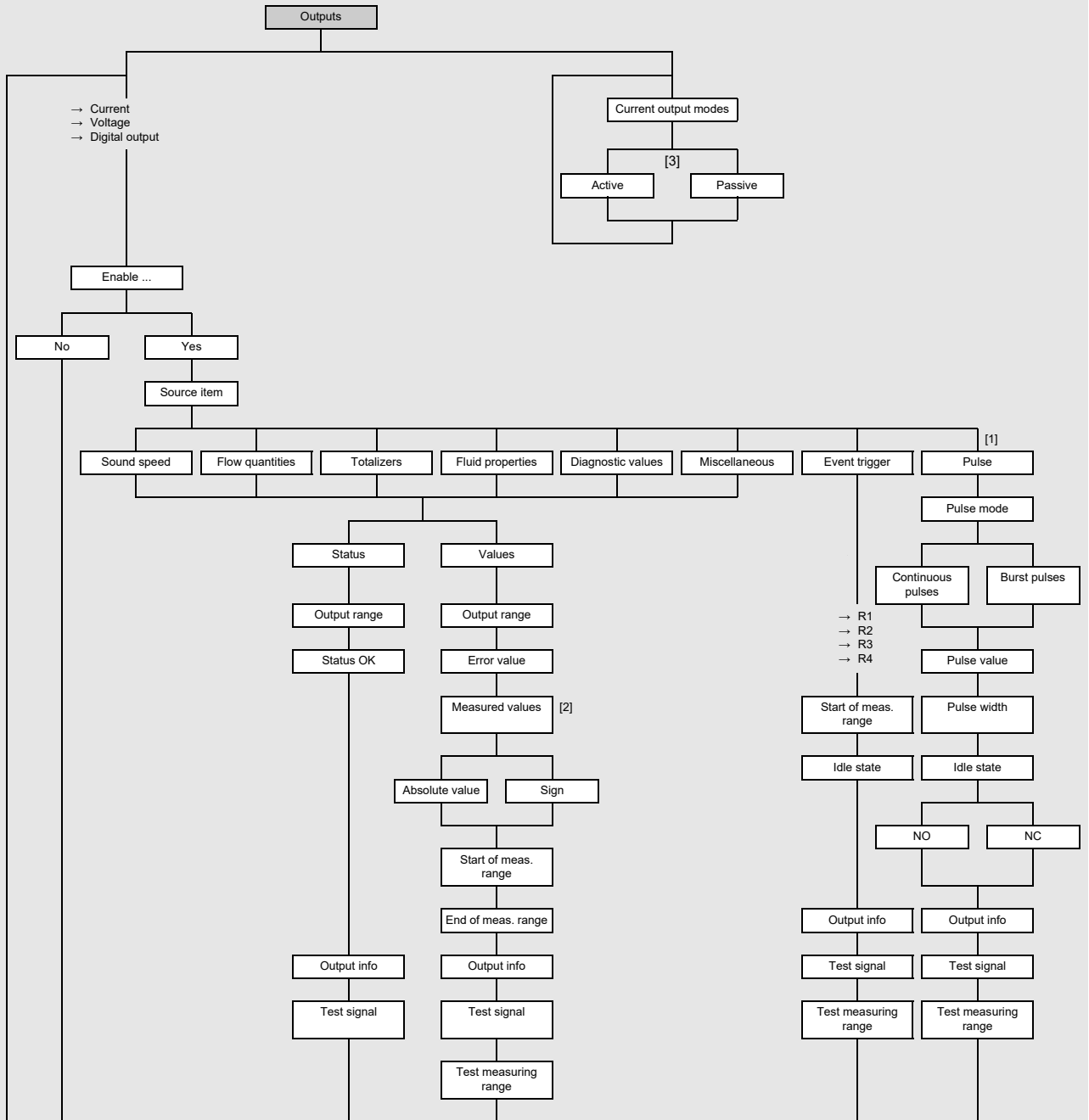

Legend

- [1] only available for digital outputs supporting pulse output
- [2] requested only if the physical quantity can adopt a negative value
- [3] only if switchable current outputs are available

Inputs

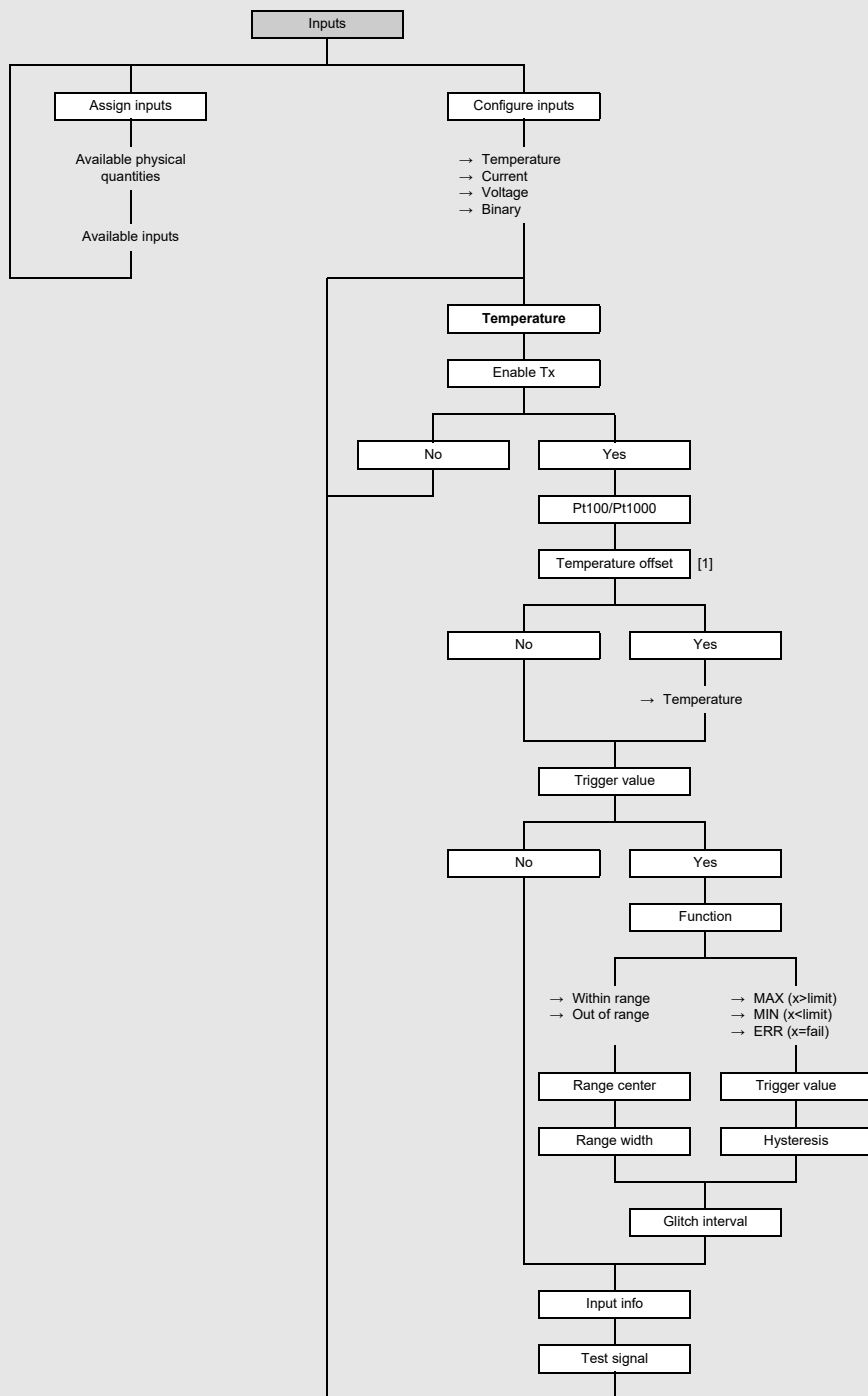

Legend
[1] only if enabled in the menu item Miscellaneous\Dialogs/Menus

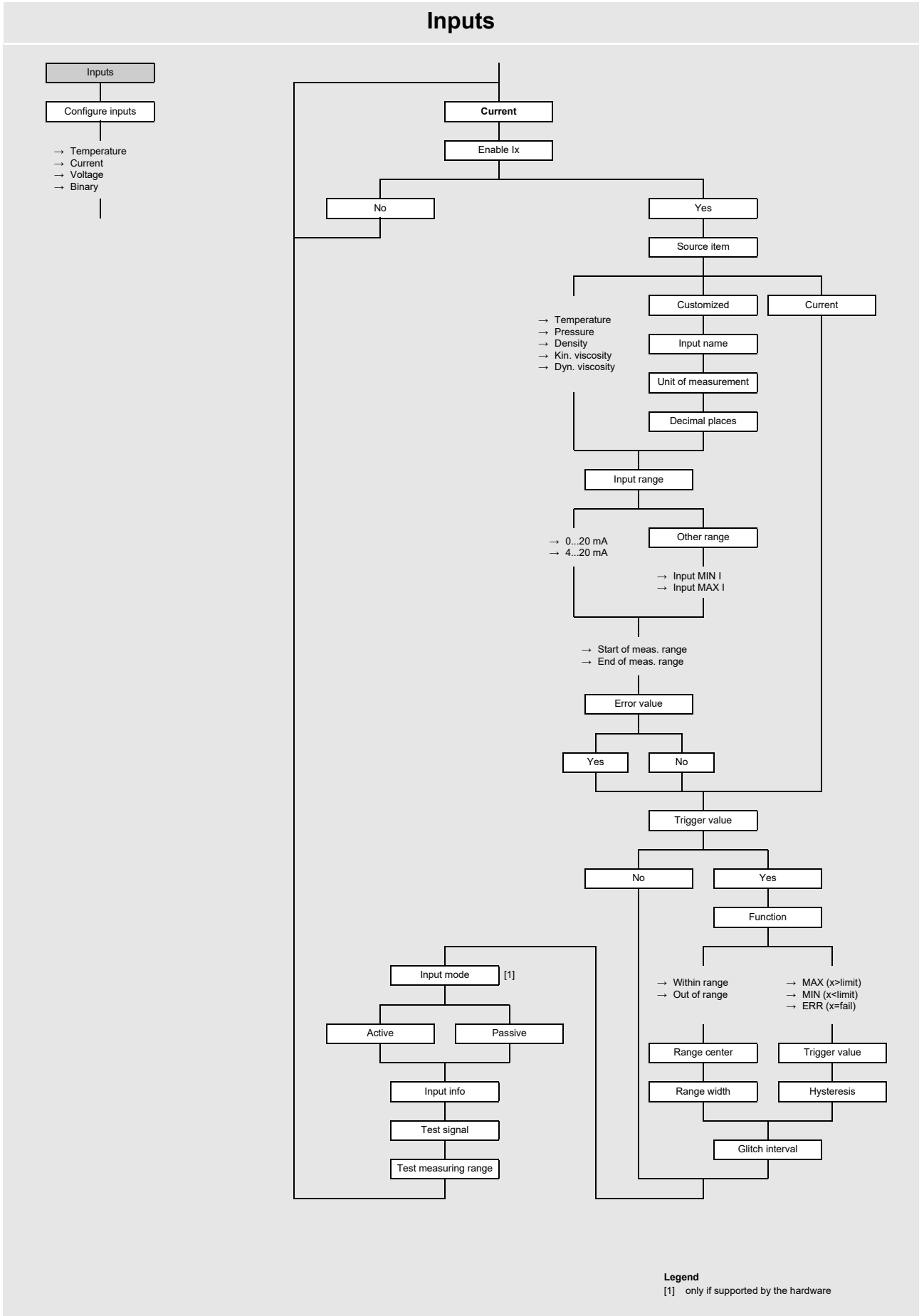

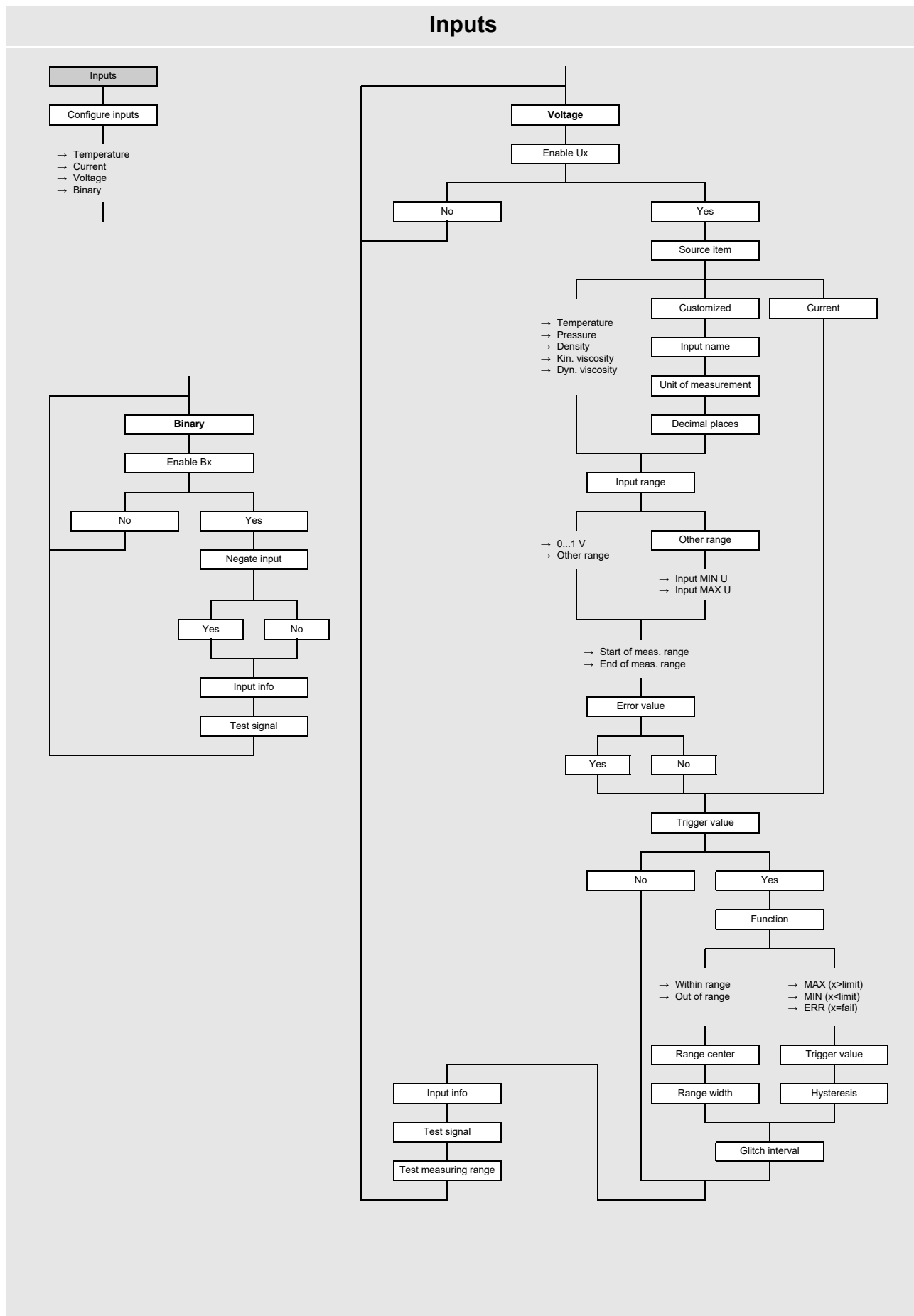

Special settings

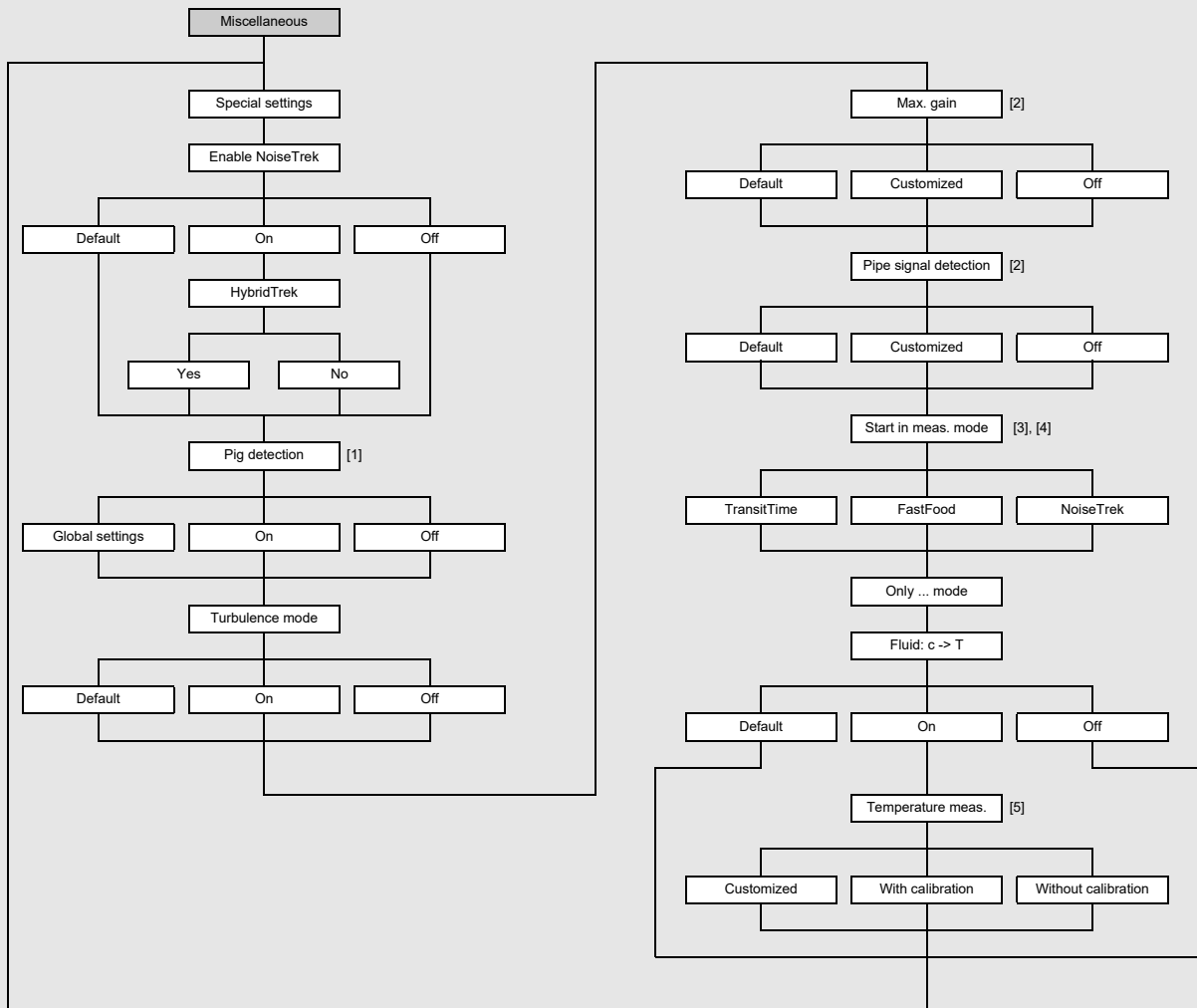

Legend

- [1] only in SuperUser mode and if activated via HotCode
- [2] only in ExpertUser, SuperUser and SuperUser ext. mode
- [3] only if FastFood mode is enabled in Miscellaneous\Measurement\Measurement modes or NoiseTrek mode is supported
- [4] only if synchronized channel averaging is deactivated
- [5] only in SuperUser mode

Calibration

If Channel-based param. is selected for the configuration of the measuring point, the settings can be made individually for each measuring channel.

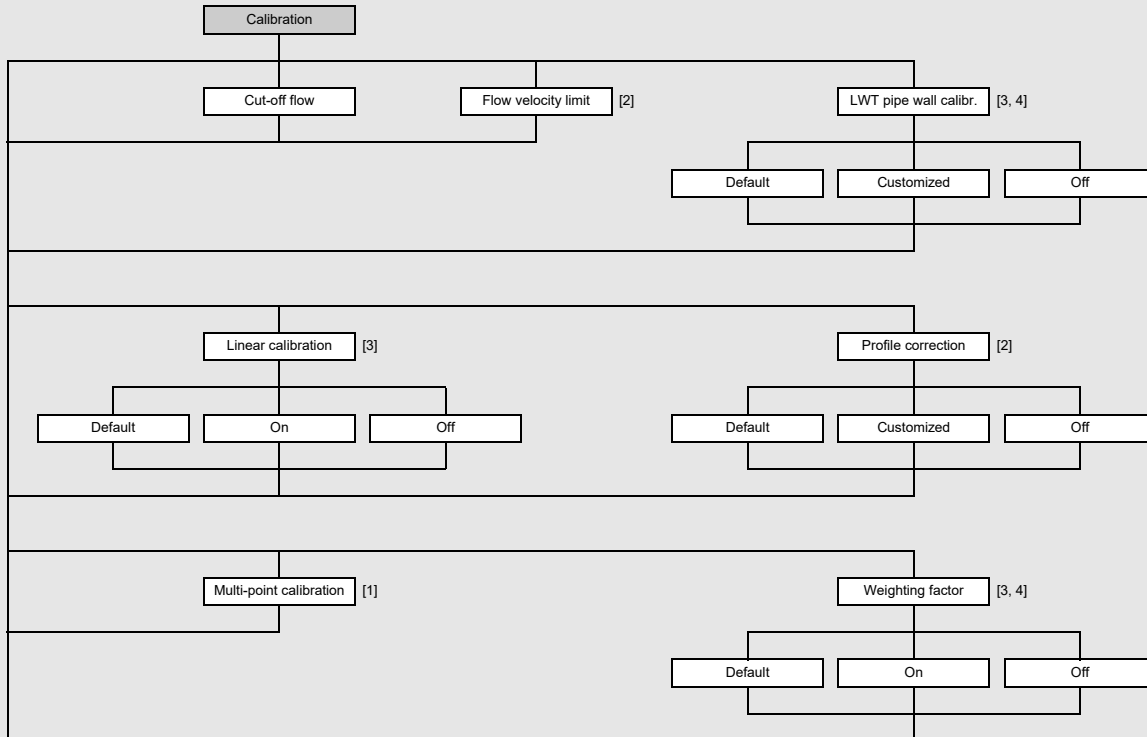

Legend

- [1] only if enabled in the menu item Miscellaneous\Measurement\Measurement settings
- [2] only in ExpertUser, SuperUser and SuperUser ext. mode
- [3] only in SuperUser and SuperUser ext. mode
- [4] if 1 meas. point (ΔB) is selected for the configuration of the measuring point, each measuring point can be configured individually

Thermal energy rate measurement

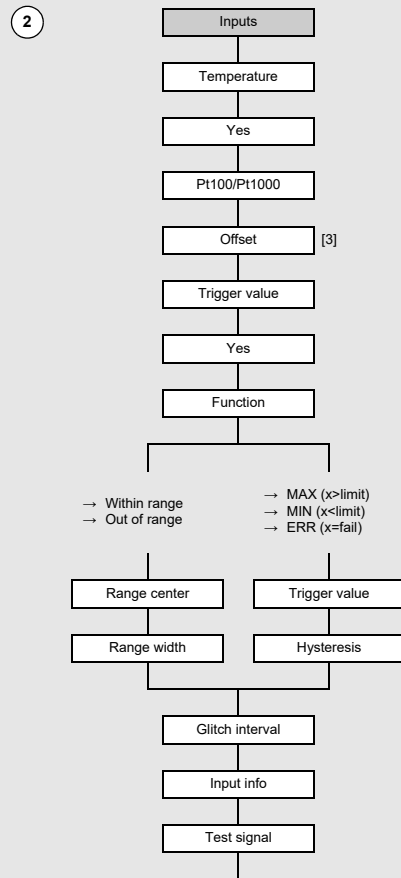
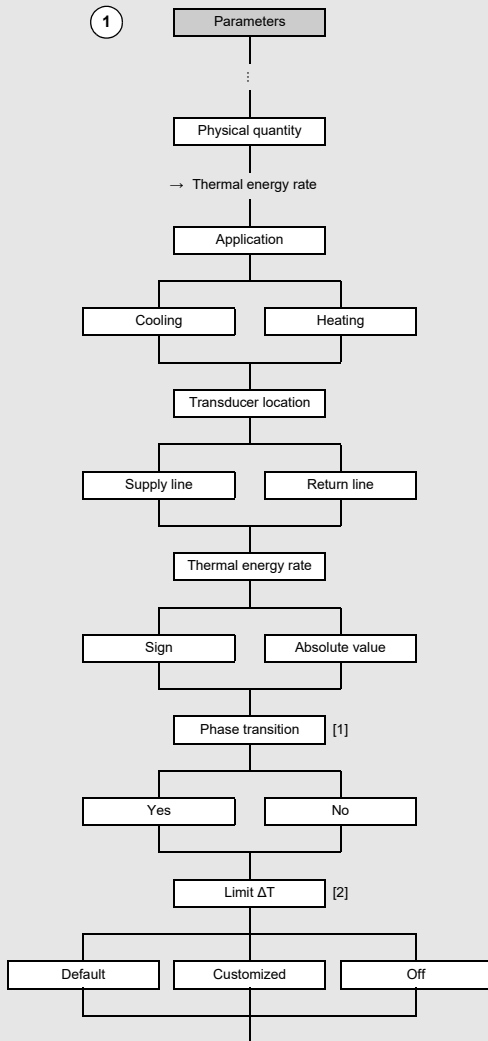

Legend

- [1] only if the corresponding data is stored for the selected fluid
- [2] only in SuperUser mode
- [3] only if enabled in the menu item `Miscellaneous\Dialogs/Menu`

Results – overview

Trigger

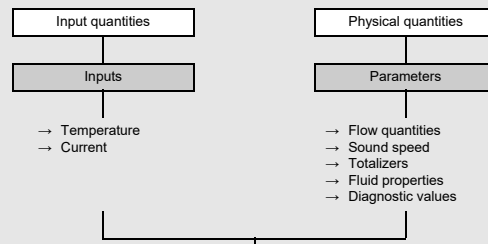

Condition

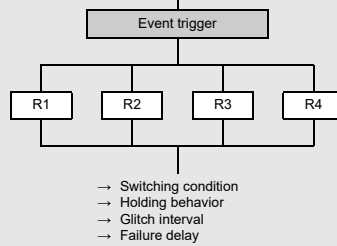

Action

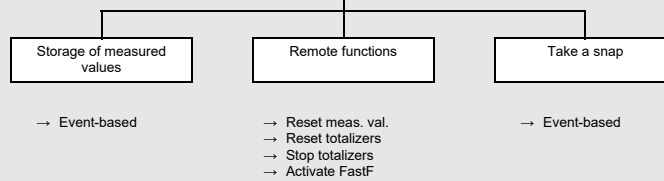

Definition of event triggers

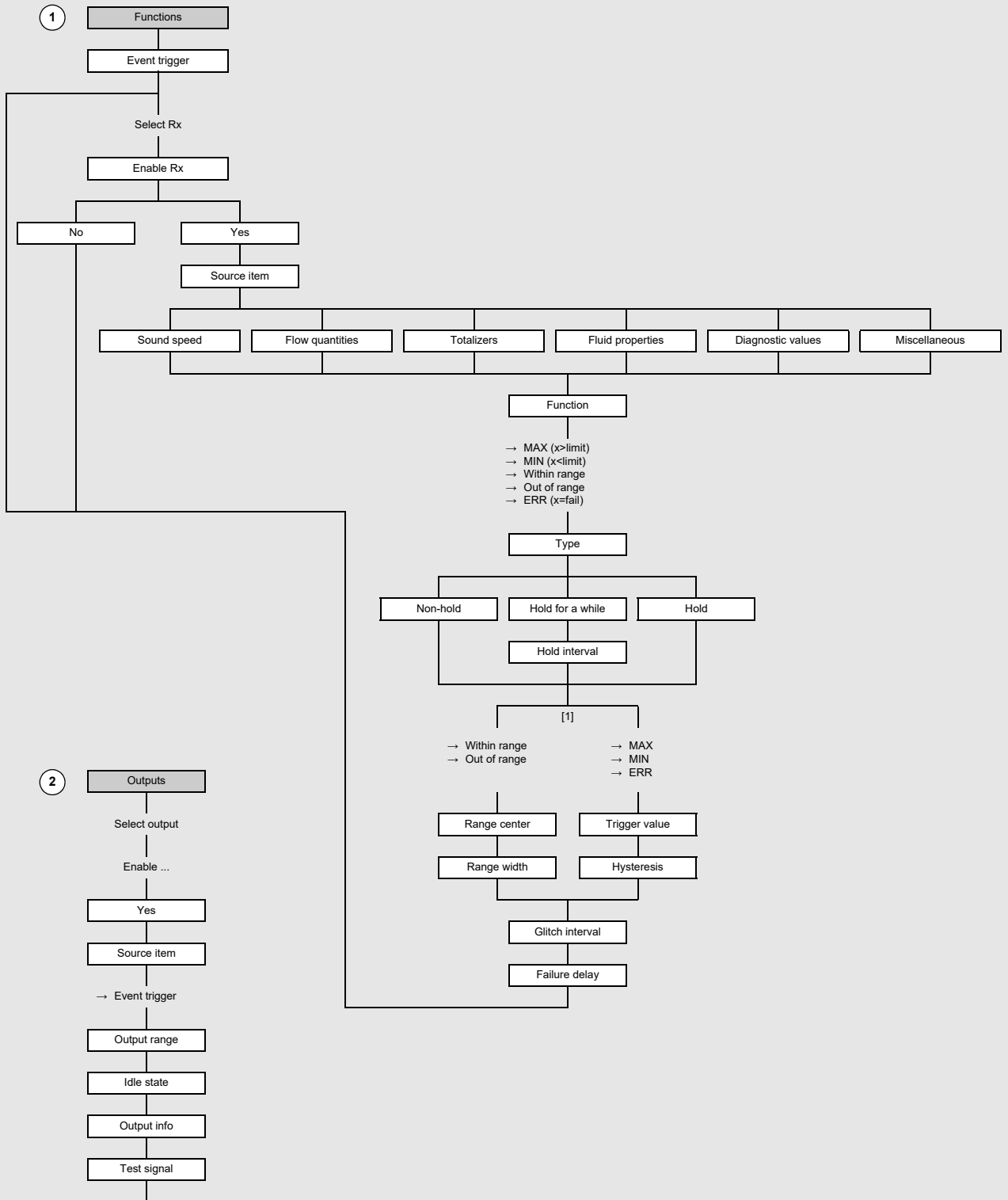

Legend
[1] depending on the selected function

Remote functions

1 Trigger

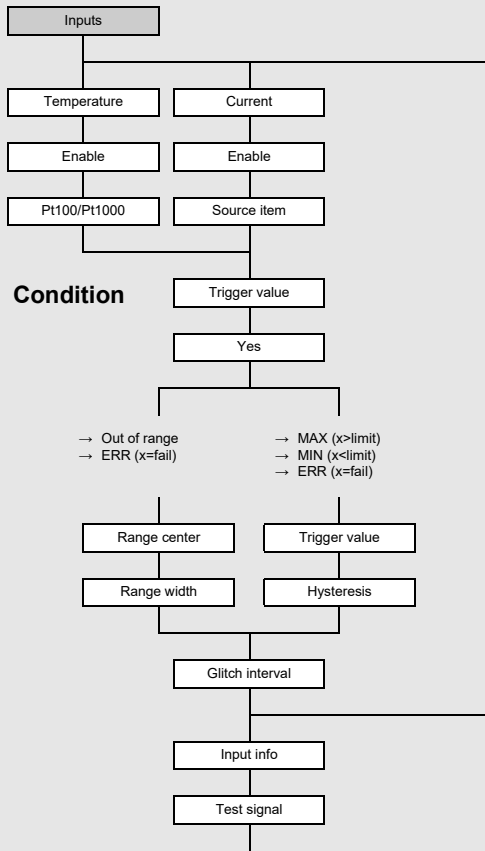

Condition

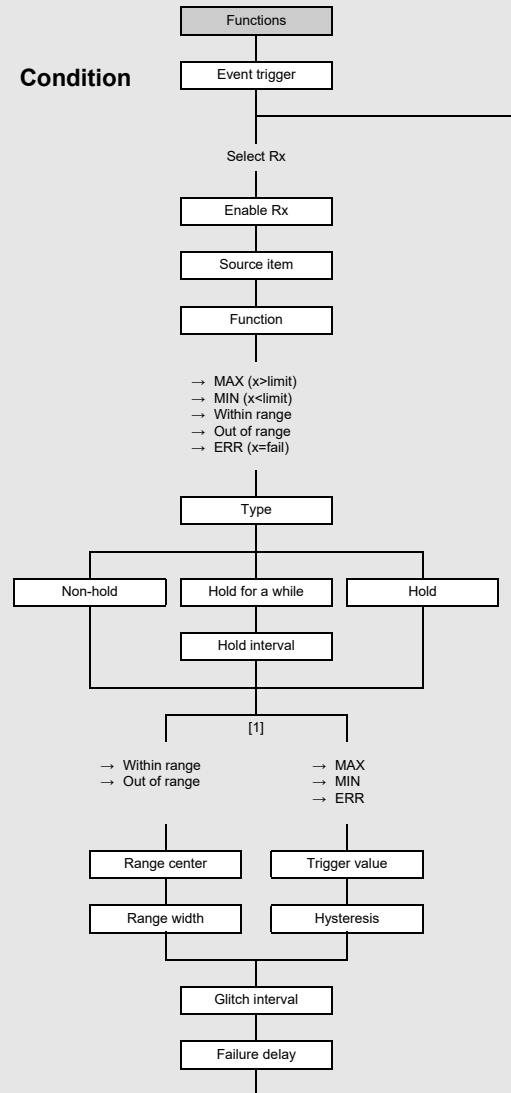

2 Action

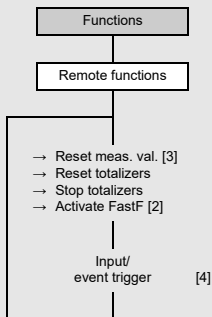

Legend

- [1] depending on the selected function
- [2] only if FastFood mode is enabled in the menu item Miscellaneous\Measurement\Measurement modes
- [3] only controllable via inputs
- [4] list of parameterized triggerable inputs and event triggers

Event-based storing of measured values

1 Trigger

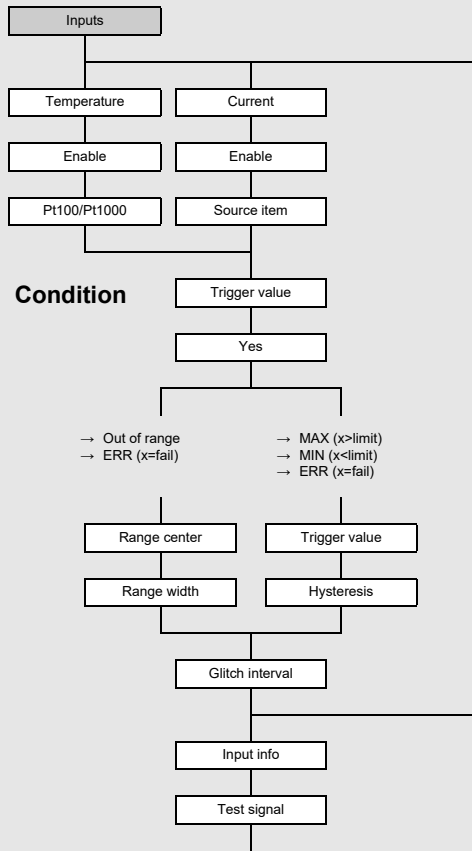

Condition

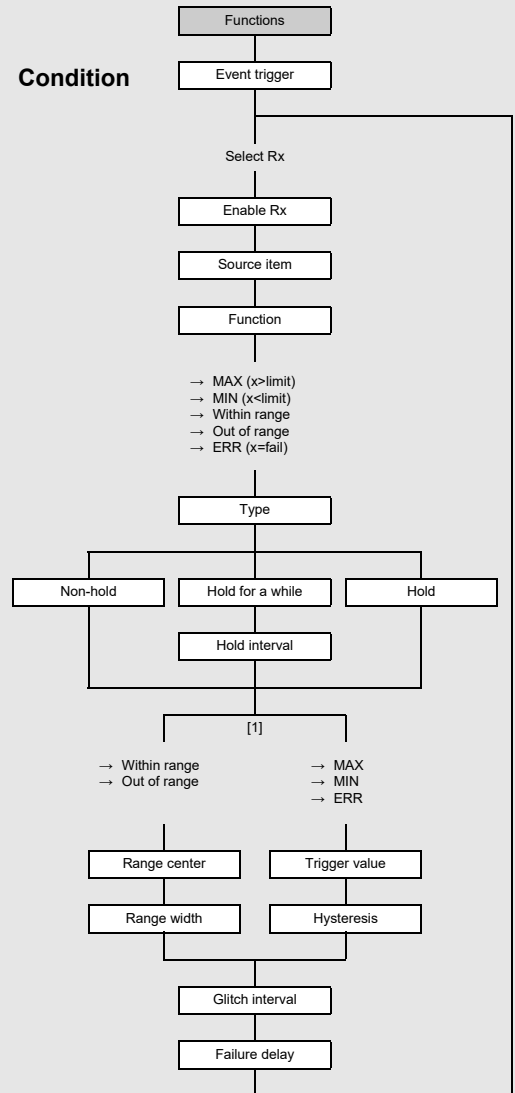

2 Action

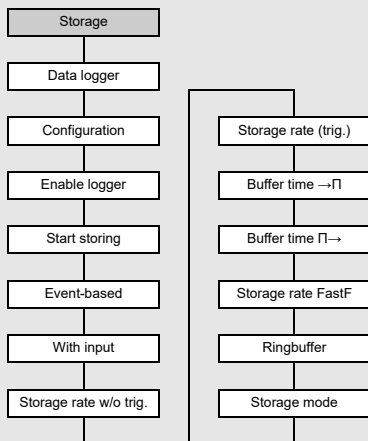

Legend

[1] depending on the selected function

Calculation channels

This function is only available in SuperUser or SuperUser ext. mode.

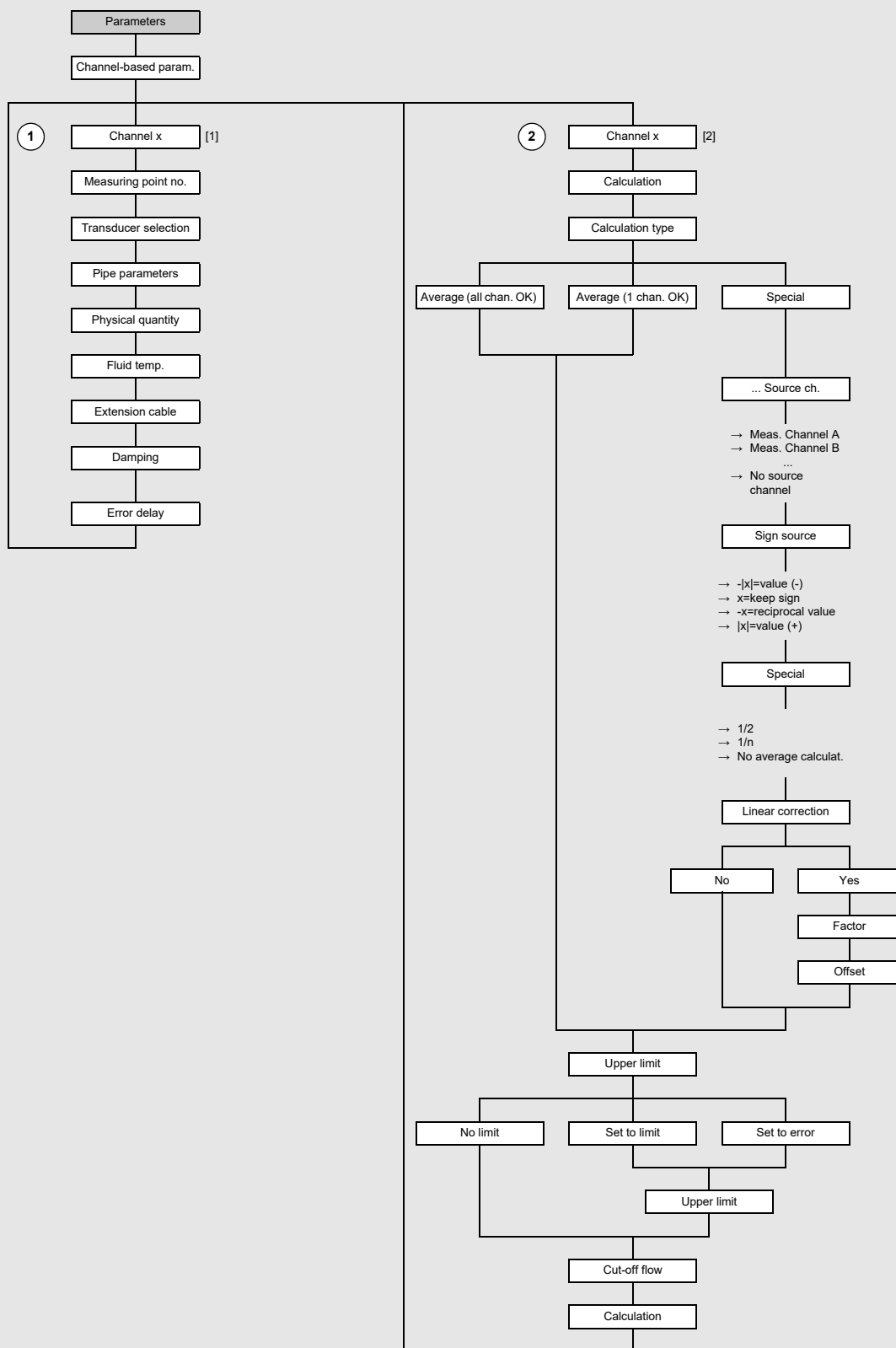

Legend
 [1] available measuring channels
 [2] calculation channel

Example 1

The diagnostic values are to be checked.
 If the SCNR is < 20 dB, a snap has to be triggered.
 trigger: SCNR < 20 dB
 condition: R1 with SCNR < 20 dB
 action: trigger a snap

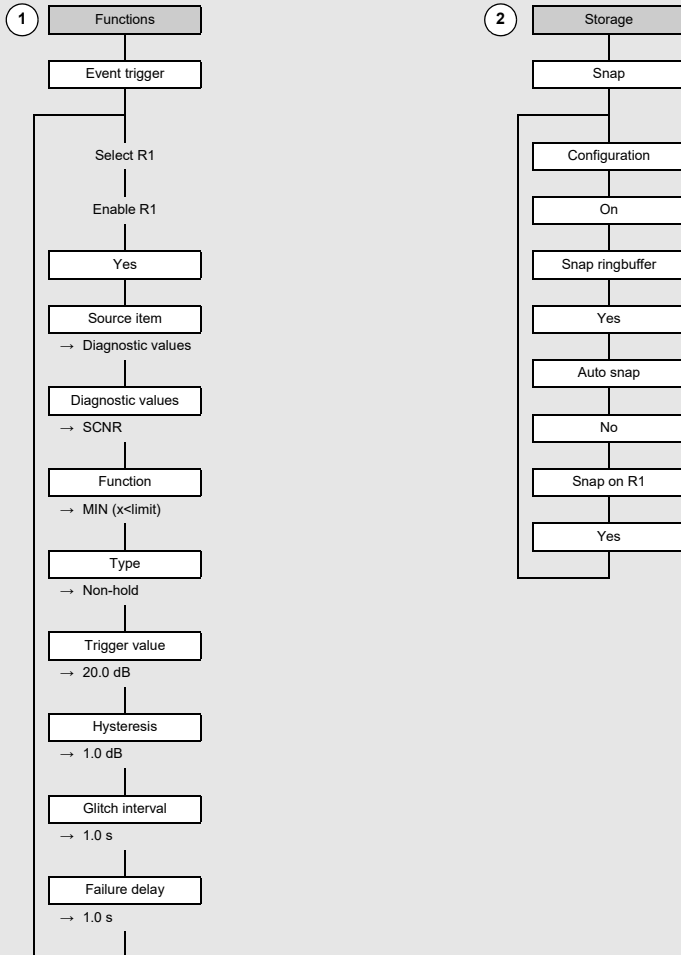

Example 2

The storage rate of all measured and diagnostic values of a certain temperature range is to be changed.

The normal storage rate of all measured and diagnostic values is 1 h. If the temperature is outside the defined range of 20...40 °C, the storage rate should be 1 min. At the same time a record has to be carried out 10 s before and 60 s after the event.

The temperature range of 0...100 °C has to be determined via a current input of 4...20 mA.

trigger: 20 °C > fluid temperature > 40 °C on current input I1

condition: I1 as trigger value outside the range 20...40 °C

action: store measured values within the temperature range 20...40 °C with a storage rate of 1 h

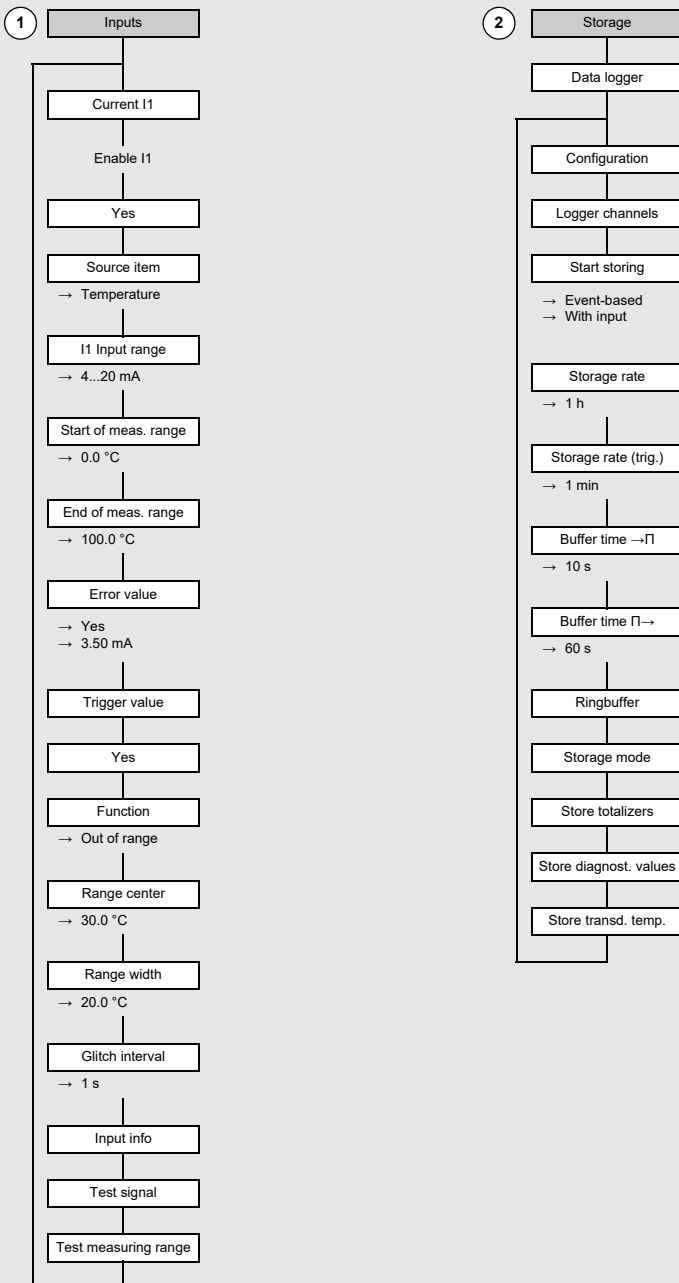

Example 3

The flow velocity is measured.

If the flow velocity is ≤ 5 m/s, the transmitter measures in the TransitTime mode. As long as the flow velocity is > 5 m/s, the transmitter has to measure in the FastFood mode.

trigger: flow velocity > 5 m/s
 condition: R1 with flow velocity > 5 m/s
 action: measurement in the FastFood mode

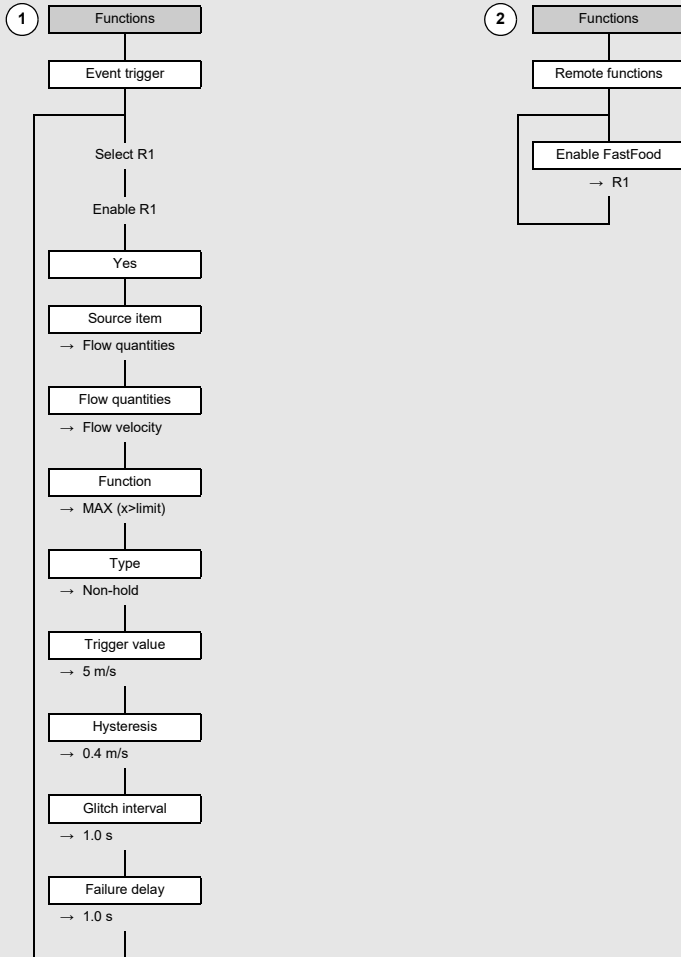

B Units of measurement

Length/roughness

unit of measurement	description
mm	millimeter
in	inch

Temperature

unit of measurement	description
°C	degree Celsius
°F	degree Fahrenheit

Pressure

unit of measurement	description
bar (a)	bar (absolute)
bar (g)	bar (relative)
psi (a)	pound per square inch (absolute)
psi (g)	pound per square inch (relative)

Density

unit of measurement	description
g/cm ³	gram per cubic centimeter
kg/cm ³	kilogram per cubic centimeter

Sound speed

unit of measurement	description
m/s	meter per second
fps (ft/s)	foot per second

Kinematic viscosity

unit of measurement	description
mm ² /s	square millimeter per second

1 mm²/s = 1 cSt

Flow velocity

unit of measurement	description
m/s	meter per second
cm/s	centimeter per second
in/s	inch per second
fps (ft/s)	foot per second

Volumetric flow rate

unit of measurement	description	default volume (totalized) ⁽¹⁾
m3/d	cubic meter per day	m3
m3/h	cubic meter per hour	m3
m3/min	cubic meter per minute	m3
m3/s	cubic meter per second	m3
km3/h	cubic kilometer per hour	km3
ml/min	milliliter per minute	l
l/h	liter per hour	l
l/min	liter per minute	l
l/s	liter per second	l
hl/h	hectoliter per hour	hl
hl/min	hectoliter per minute	hl
hl/s	hectoliter per second	hl
Ml/d (Megalit/d)	megaliter per day	Ml
bb1/d ⁽⁴⁾	barrel per day	bb1
bb1/h ⁽⁴⁾	barrel per hour	bb1
bb1/m ⁽⁴⁾	barrel per minute	bb1
bb1/s ⁽⁴⁾	barrel per second	bb1
USgpd (US-gal/d)	gallon per day	gal
USgph (US-gal/h)	gallon per hour	gal
USgpm (US-gal/m)	gallon per minute	gal
USgps (US-gal/s)	gallon per second	gal
KGPM (US-Kgal/m)	kilogallon per minute	kgal
MGD (US-Mgal/d)	million gallons per day	Mgal
CFD	cubic foot per day	cft ⁽²⁾
CFH	cubic foot per hour	cft
CFM	cubic foot per minute	cft
CFS	cubic foot per second	aft ⁽³⁾
CCFD	hundred cubic feet per day	CCF
CCFH	hundred cubic feet per hour	CCF

(1) selection via Parameters\Units of measurement

(2) cft: cubic foot

(3) aft: acre foot

(4) In the menu item Miscellaneous\Units of measurement\Barrel type the barrel type to be displayed when setting the units of measurement for volumetric flow rate and totalized volume can be defined. If the barrel type Imperial (UK) is selected, imperial (UK) gallons instead of US gallons are used.

1 US-gal = 3.78541 l

1 UK-gal = 4.54609 l

US Barrel Oil = 42.0 US-gal ≈ 159 l

US Barrel Wine = 31.5 US-gal ≈ 119 l

US Barrel Beer = 31.0 US-gal ≈ 117 l

Imperial (UK) Barrel = 36.0 UK-gal ≈ 164 l

unit of measurement	description	default volume (totalized) ⁽¹⁾
MMCFD	million cubic feet per day	MMCF
MMCFH	million cubic feet per hour	MMCF
Igpd (Imp-gal/d)	gallon per day	Igal
Igph (Imp-gal/h)	gallon per hour	Igal
Igpm (Imp-gal/m)	gallon per minute	Igal
Igps (Imp-gal/s)	gallon per second	Igal
IKGM (Imp-Kgal/m)	imperial kilogallon per minute	IKG
IMGD (Imp-Mgal/d)	million imperial gallons per day	IMG

⁽¹⁾ selection via Parameters\Units of measurement

⁽²⁾ cft: cubic foot

⁽³⁾ aft: acre foot

⁽⁴⁾ In the menu item Miscellaneous\Units of measurement\Barrel type the barrel type to be displayed when setting the units of measurement for volumetric flow rate and totalized volume can be defined. If the barrel type Imperial (UK) is selected, imperial (UK) gallons instead of US gallons are used.

1 US-gal = 3.78541 l

1 UK-gal = 4.54609 l

US Barrel Oil = 42.0 US-gal ≈ 159 l

US Barrel Wine = 31.5 US-gal ≈ 119 l

US Barrel Beer = 31.0 US-gal ≈ 117 l

Imperial (UK) Barrel = 36.0 UK-gal ≈ 164 l

Thermal energy rate

unit of measurement	description	thermal energy (totalized) ⁽¹⁾
W	watt	Wh
kW	kilowatt	kWh
MW	megawatt	MWh
GW	gigawatt	GWh
kBTU/minute	kBTU per minute	kBT
kBTU/hour	kBTU per hour	kBT
MBTU/hour	MBTU per hour	MBT
MBTU/day	MBTU per day	MBT
TON (TH)	TON, totals in TONhours	TH
TON (TD)	TON, totals in TONdays	TD
kTON (kTH)	kTON, totals in kTONhours	kTH
kTON (kTD)	kTON, totals in kTONdays	kTD

BTU: British Thermal Unit

1 W = 1 J/s = (1/1055.05585262) BTU/s

TON: ton of refrigeration

1 W = 1 J/s = (1/3516.852842) TON

1 TON = 200 BTU/min

⁽¹⁾ selection via Parameters\Units of measurement

Mass flow rate

unit of measurement	description
t/h	ton per hour
t/d	ton per day
kg/h	kilogram per hour
kg/min	kilogram per minute
kg/s	kilogram per second
g/s	gram per second
lb/d	pound per day
lb/h	pound per hour
lb/m	pound per minute
lb/s	pound per second
klb/h	kilopound per hour
klb/m	kilopound per minute

1 lb = 453.59237 g
1 t = 1000 kg

mass (totalized)
t
t
kg
kg
kg
g
lb
lb
lb
lb
klb
klb

C Reference

The following tables provide assistance for the user. The accuracy of the data depends on the composition, temperature and processing of the material. FLEXIM does not assume liability for any inaccuracies.

C.1 Sound speed of selected pipe and lining materials at 20 °C

The values of some of these materials are stored in the internal database of the transmitter. Column c_{flow} shows the type of sound wave (longitudinal or transversal) used for the flow measurement.

material (display)	explanation	c_{trans} [m/s]	c_{long} [m/s]	c_{flow}
Carbon steel	steel, normal	3230	5930	trans
Stainless steel	steel, stainless	3100	5790	trans
DUPLEX	duplex stainless steel	3272	5720	trans
Ductile iron	ductile iron	2650	-	trans
Asbestos cement	asbestos cement	2200	-	trans
Titanium	titanium	3067	5955	trans
Copper	copper	2260	4700	trans
Aluminum	aluminum	3100	6300	trans
Brass	brass	2100	4300	trans
Plastic	plastic	1120	2000	long
GRP	glass reinforced plastic	-	2650	long
PVC	polyvinyl chloride	-	2395	long
PE	polyethylene	540	1950	long
PP	polypropylene	2600	2550	trans
Bitumen	bitumen	2500	-	trans
Acrylic glass	acrylic glass	1250	2730	long
Lead	lead	700	2200	long
Cu-Ni-Fe	copper-nickel-iron alloy	2510	4900	trans
Cast iron	gray cast iron	2200	4600	trans
Rubber	rubber	1900	2400	trans
Glass	glass	3400	5600	trans
PFA	perfluoralkoxy	500	1185	long
PVDF	polyvinylidene fluorid	760	2050	long
Sintimid	Sintimid	-	2472	long
Teka PEEK	Teka PEEK	-	2534	long
Tekason	Tekason	-	2230	long

The sound speed depends on the composition and processing of the material. The sound speed of alloys and cast materials fluctuates strongly. The values only serve as an orientation.

C.2 Typical roughness values of pipes

The values are based on experience and measurements.

material	absolute roughness [mm]
drawn pipes of non-ferrous metal, glass, plastics and light metal	0...0.0015
drawn steel pipes	0.01...0.05
fine-planed, polished surface	max. 0.01
planed surface	0.01...0.04
rough-planed surface	0.05...0.1
welded steel pipes, new	0.05...0.1
after long use, cleaned	0.15...0.2
moderately rusted, slightly encrusted	max. 0.4
heavily encrusted	max. 3
cast iron pipes:	
bitumen lining	> 0.12
new, without lining	0.25...1
rusted	1...1.5
encrusted	1.5...3

C.3 Typical properties of selected fluids at 20 °C

C.3.1 Mixtures with non-changing composition

fluid	explanation	sound speed [m/s]	density [kg/m ³]	kinematic viscosity [mm ² /s]	valid range of fluid data [°C]	WMM ⁽¹⁾
Water	liquid water	1482	999	1	0...350	x
Propane	liquefied under pressure	755	500	0.2	-180...+97	
Butane	liquefied under pressure, coolant R-600	929	577	0.3	-135...+152	x
Ammonia	liquefied under pressure, coolant R-717	1373	610	0.2	-78...+132	x
Methanol		1119	792	0.7	-95...+240	
Ethanol		1158	789	1.5	-110...+241	
Acetone		1187	791	0.4	-90...+235	
R134a HFC	coolant HFC	521	1240	0.2	-100...+100	x
R407C HFC	coolant HFC	494	1158	0.1	-20...+81	x
R410A HFC	coolant HFC	457	1085	0.1	-130...+71	x
R22 CFC	coolant HFC	557	1213	0.1	-150...+90	x
BP Transcal LT	thermal oil	1365	876	20	-20...+260	x
BP Transcal N	thermal oil	1365	876	94	0...320	x
Shell Thermia B	thermal oil	1365	863	89	0...310	x
Mobiltherm 594	thermal oil	1365	873	7.5	-44...+260	x
Mobiltherm 603	thermal oil	1365	859	55	0...320	x
Gasoline	hydrocarbon with 58 °API	1252	741	1.1	-50...+450	
Diesel	hydrocarbon with 38 °API	1380	831	2.2	-50...+450	
Jet A1	hydrocarbon with 44 °API	1358	821	1.7	-50...+450	

⁽¹⁾ thermal energy rate coefficient included in the fluid data set

C.3.2 Mixtures with changing composition

fluid	explanation	parametri- zation ⁽¹⁾	sound speed [m/s]	density [kg/m ³]	kinematic viscosity [mm ² /s]	valid range of fluid data	WMM ⁽²⁾
Glycol/H ₂ O	ethylene glycol	proportion of glycol	1482...1710	999...1132	1...23	-30...+150 °C 0...100 %	x
Petroleum	hydrocarbon	API gravity	530...1800	440...1130	1...> 400	-50...+450 °C -10...+200 °API	
Lubricant	hydrocarbon- based lubricant, kinematic viscosity at 40 °C	viscosity grade (VG)	1433...1485	871...923	1...> 400	-40...+300 °C 1...1500 VG	
Sea water		salinity (S in g/kg)	1482...1840	999...1230	1...1.3	-30...+150 °C 0...300 g/kg	x
Sulfuric acid	mixture of sulfuric acid and water	proportion of sulfuric acid	1280...1560	999...1907	1...12	-20...+250 °C 0...100 %	
Hydrochloric acid	mixture of hydrochloric acid and water	proportion of hydrochloric acid	1482...1527	999...1256	1...1.5	-20...+150 °C 0...50 %	
Nitric acid	mixture of nitric acid and water	proportion of nitric acid	1286...1590	999...1554	1...2.4	-20...+150 °C 0...100 %	
Hydrofluoric acid	mixture of hydrofluoric acid and water	proportion of hydrofluoric acid	804...1482	999...1195	0.5...1	-20...+105 °C 0...100 %	
Soda lye	mixture of soda lye and water	proportion of soda lye	1482...2563	999...1666	1...265	-10...+200 °C 0...65 %	

⁽¹⁾ in menu Parameters⁽²⁾ thermal energy rate coefficient included in the fluid data set

C.4 Properties of water at 1 bar and at saturation pressure

fluid temperature [°C]	fluid pressure [bar]	sound speed [m/s]	density [kg/m ³]	specific heat capacity ⁽¹⁾ [kJ/kg/K ⁻¹]
0.1	1.013	1402.9	999.8	4.219
10	1.013	1447.3	999.7	4.195
20	1.013	1482.3	998.2	4.184
30	1.013	1509.2	995.6	4.180
40	1.013	1528.9	992.2	4.179
50	1.013	1542.6	988.0	4.181
60	1.013	1551.0	983.2	4.185
70	1.013	1554.7	977.8	4.190
80	1.013	1554.4	971.8	4.197
90	1.013	1550.5	965.3	4.205
100	1.013	1543.2	958.3	4.216
120	1.985	1519.9	943.1	4.244
140	3.615	1486.2	926.1	4.283
160	6.182	1443.2	907.4	4.335
180	10.03	1391.7	887.0	4.405
200	15.55	1332.1	864.7	4.496
220	23.20	1264.5	840.2	4.615
240	33.47	1189.0	813.4	4.772
260	46.92	1105.3	783.6	4.986
280	64.17	1012.6	750.3	5.289
300	85.88	909.40	712.1	5.750
320	112.8	793.16	667.1	6.537
340	146.0	658.27	610.7	8.208
360	186.7	479.74	527.6	15.00
373.946	220.640	72.356	322.0	∞

⁽¹⁾ at constant pressure

D Legal information – open source licenses

The software of this product contains the following open-source software which is subject to the Apache license version 2.0 dated January 2004:

1. uC-TCP-IP

<https://github.com/weston-embedded/uC-TCP-IP/tree/v3.06.01>

<https://github.com/weston-embedded/uC-TCP-IP/blob/v3.06.01/LICENSE>

<https://github.com/weston-embedded/uC-TCP-IP/blob/v3.06.01/NOTICE>

ATTENTION ALL USERS OF THIS REPOSITORY:

The original work found in this repository is provided by Silicon Labs under the Apache License, Version 2.0.

Any third party may contribute derivative works to the original work in which modifications are clearly identified as being licensed under:

- (1) the Apache License, Version 2.0 or a compatible open source license; or
- (2) under a proprietary license with a copy of such license deposited.

All posted derivative works must clearly identify which license choice has been elected.

No such posted derivative works will be considered to be a "Contribution" under the Apache License, Version 2.0.

SILICON LABS MAKES NO WARRANTY WITH RESPECT TO ALL POSTED THIRD PARTY CONTENT AND DISCLAIMS ALL OTHER WARRANTIES OR LIABILITIES, INCLUDING ALL WARRANTIES OF MERCHANTABILITY, FITNESS FOR A PARTICULAR PURPOSE, TITLE, OWNERSHIP, NON-INFRINGEMENT, AND NON-MISAPPROPRIATION.

In the event a derivative work is desired to be submitted to Silicon Labs as a "Contribution" under the Apache License, Version 2.0, a "Contributor" must give written email notice to micrium@weston-embedded.com. Unless an email response in the affirmative to accept the derivative work as a "Contribution", such email submission should be considered to have not been incorporated into the original work.

2. uC-Common

<https://github.com/weston-embedded/uC-Common/tree/v1.02.01>

<https://github.com/weston-embedded/uC-Common/blob/v1.02.01/LICENSE>

<https://github.com/weston-embedded/uC-Common/blob/v1.02.01/NOTICE>

ATTENTION ALL USERS OF THIS REPOSITORY:

The original work found in this repository is provided by Silicon Labs under the Apache License, Version 2.0.

Any third party may contribute derivative works to the original work in which modifications are clearly identified as being licensed under:

- (1) the Apache License, Version 2.0 or a compatible open source license; or
- (2) under a proprietary license with a copy of such license deposited.

All posted derivative works must clearly identify which license choice has been elected.

No such posted derivative works will be considered to be a "Contribution" under the Apache License, Version 2.0.

SILICON LABS MAKES NO WARRANTY WITH RESPECT TO ALL POSTED THIRD PARTY CONTENT AND DISCLAIMS ALL OTHER WARRANTIES OR LIABILITIES, INCLUDING ALL WARRANTIES OF MERCHANTABILITY, FITNESS FOR A PARTICULAR PURPOSE, TITLE, OWNERSHIP, NON-INFRINGEMENT, AND NON-MISAPPROPRIATION.

In the event a derivative work is desired to be submitted to Silicon Labs as a "Contribution" under the Apache License, Version 2.0, a "Contributor" must give written email notice to micrium@weston-embedded.com. Unless an email response in the affirmative to accept the derivative work as a "Contribution", such email submission should be considered to have not been incorporated into the original work.

3. uC-DHCPc

<https://github.com/weston-embedded/uC-DHCPc/tree/v2.11.01>

<https://github.com/weston-embedded/uC-DHCPc/blob/v2.11.01/LICENSE>

<https://github.com/weston-embedded/uC-DHCPc/blob/v2.11.01/NOTICE>

ATTENTION ALL USERS OF THIS REPOSITORY:

The original work found in this repository is provided by Silicon Labs under the Apache License, Version 2.0.

Any third party may contribute derivative works to the original work in which modifications are clearly identified as being licensed under:

- (1) the Apache License, Version 2.0 or a compatible open source license; or
- (2) under a proprietary license with a copy of such license deposited.

All posted derivative works must clearly identify which license choice has been elected.

No such posted derivative works will be considered to be a "Contribution" under the Apache License, Version 2.0.

SILICON LABS MAKES NO WARRANTY WITH RESPECT TO ALL POSTED THIRD PARTY CONTENT AND DISCLAIMS ALL OTHER WARRANTIES OR LIABILITIES, INCLUDING ALL WARRANTIES OF MERCHANTABILITY, FITNESS FOR A PARTICULAR PURPOSE, TITLE, OWNERSHIP, NON-INFRINGEMENT, AND NON-MISAPPROPRIATION.

In the event a derivative work is desired to be submitted to Silicon Labs as a "Contribution" under the Apache License, Version 2.0, a "Contributor" must give written email notice to micrium@weston-embedded.com. Unless an email response in the affirmative to accept the derivative work as a "Contribution", such email submission should be considered to have not been incorporated into the original work.

4. uC-LIB

<https://github.com/weston-embedded/uC-LIB/tree/v1.39.01>

<https://github.com/weston-embedded/uC-LIB/blob/v1.39.01/LICENSE>

<https://github.com/weston-embedded/uC-LIB/blob/v1.39.01/NOTICE>

ATTENTION ALL USERS OF THIS REPOSITORY:

The original work found in this repository is provided by Silicon Labs under the Apache License, Version 2.0.

Any third party may contribute derivative works to the original work in which modifications are clearly identified as being licensed under:

- (1) the Apache License, Version 2.0 or a compatible open source license; or
- (2) under a proprietary license with a copy of such license deposited.

All posted derivative works must clearly identify which license choice has been elected.

No such posted derivative works will be considered to be a "Contribution" under the Apache License, Version 2.0.

SILICON LABS MAKES NO WARRANTY WITH RESPECT TO ALL POSTED THIRD PARTY CONTENT AND DISCLAIMS ALL OTHER WARRANTIES OR LIABILITIES, INCLUDING ALL WARRANTIES OF MERCHANTABILITY, FITNESS FOR A PARTICULAR PURPOSE, TITLE, OWNERSHIP, NON-INFRINGEMENT, AND NON-MISAPPROPRIATION.

In the event a derivative work is desired to be submitted to Silicon Labs as a "Contribution" under the Apache License, Version 2.0, a "Contributor" must give written email notice to micrium@weston-embedded.com. Unless an email response in the affirmative to accept the derivative work as a "Contribution", such email submission should be considered to have not been incorporated into the original work.

Apache License

Version 2.0, January 2004

<http://www.apache.org/licenses/>

TERMS AND CONDITIONS FOR USE, REPRODUCTION, AND DISTRIBUTION

1. Definitions.

"License" shall mean the terms and conditions for use, reproduction, and distribution as defined by Sections 1 through 9 of this document.

"Licensor" shall mean the copyright owner or entity authorized by the copyright owner that is granting the License.

"Legal Entity" shall mean the union of the acting entity and all other entities that control, are controlled by, or are under common control with that entity. For the purposes of this definition, "control" means (i) the power, direct or indirect, to cause the direction or management of such entity, whether by contract or otherwise, or (ii) ownership of fifty percent (50 %) or more of the outstanding shares, or (iii) beneficial ownership of such entity.

"You" (or "Your") shall mean an individual or Legal Entity exercising permissions granted by this License.

"Source" form shall mean the preferred form for making modifications, including but not limited to software source code, documentation source, and configuration files.

"Object" form shall mean any form resulting from mechanical transformation or translation of a Source form, including but not limited to compiled object code, generated documentation, and conversions to other media types.

"Work" shall mean the work of authorship, whether in Source or Object form, made available under the License, as indicated by a copyright notice that is included in or attached to the work (an example is provided in the Appendix below).

"Derivative Works" shall mean any work, whether in Source or Object form, that is based on (or derived from) the Work and for which the editorial revisions, annotations, elaborations, or other modifications represent, as a whole, an original work of authorship. For the purposes of this License, Derivative Works shall not include works that remain separable from, or merely link (or bind by name) to the interfaces of, the Work and Derivative Works thereof.

"Contribution" shall mean any work of authorship, including the original version of the Work and any modifications or additions to that Work or Derivative Works thereof, that is intentionally submitted to Licensor for inclusion in the Work by the copyright owner or by an individual or Legal Entity authorized to submit on behalf of the copyright owner. For the purposes of this definition, "submitted" means any form of electronic, verbal, or written communication sent to the Licensor or its representatives, including but not limited to communication on electronic mailing lists, source code control systems, and issue tracking systems that are managed by, or on behalf of, the Licensor for the purpose of discussing and improving the Work, but excluding communication that is conspicuously marked or otherwise designated in writing by the copyright owner as "Not a Contribution."

"Contributor" shall mean Licensor and any individual or Legal Entity on behalf of whom a Contribution has been received by Licensor and subsequently incorporated within the Work.

2. Grant of Copyright License. Subject to the terms and conditions of this License, each Contributor hereby grants to You a perpetual, worldwide, non-exclusive, no-charge, royalty-free, irrevocable copyright license to reproduce, prepare Derivative Works of, publicly display, publicly perform, sublicense, and distribute the Work and such Derivative Works in Source or Object form.
3. Grant of Patent License. Subject to the terms and conditions of this License, each Contributor hereby grants to You a perpetual, worldwide, non-exclusive, no-charge, royalty-free, irrevocable (except as stated in this section) patent license to make, have made, use, offer to sell, sell, import, and otherwise transfer the Work, where such license applies only to those patent claims licensable by such Contributor that are necessarily infringed by their Contribution(s) alone or by combination of their Contribution(s) with the Work to which such Contribution(s) was submitted. If You institute patent litigation against any entity (including a cross-claim or counterclaim in a lawsuit) alleging that the Work or a Contribution incorporated within the Work constitutes direct or contributory patent infringement, then any patent licenses granted to You under this License for that Work shall terminate as of the date such litigation is filed.
4. Redistribution. You may reproduce and distribute copies of the Work or Derivative Works thereof in any medium, with or without modifications, and in Source or Object form, provided that You meet the following conditions:
 - (a) You must give any other recipients of the Work or Derivative Works a copy of this License; and
 - (b) You must cause any modified files to carry prominent notices stating that You changed the files; and
 - (c) You must retain, in the Source form of any Derivative Works that You distribute, all copyright, patent, trademark, and attribution notices from the Source form of the Work, excluding those notices that do not pertain to any part of the Derivative Works; and

(d) If the Work includes a "NOTICE" text file as part of its distribution, then any Derivative Works that You distribute must include a readable copy of the attribution notices contained within such NOTICE file, excluding those notices that do not pertain to any part of the Derivative Works, in at least one of the following places: within a NOTICE text file distributed as part of the Derivative Works; within the Source form or documentation, if provided along with the Derivative Works; or, within a display generated by the Derivative Works, if and wherever such third-party notices normally appear. The contents of the NOTICE file are for informational purposes only and do not modify the License. You may add Your own attribution notices within Derivative Works that You distribute, alongside or as an addendum to the NOTICE text from the Work, provided that such additional attribution notices cannot be construed as modifying the License.

You may add Your own copyright statement to Your modifications and may provide additional or different license terms and conditions for use, reproduction, or distribution of Your modifications, or for any such Derivative Works as a whole, provided Your use, reproduction, and distribution of the Work otherwise complies with the conditions stated in this License.

5. **Submission of Contributions.** Unless You explicitly state otherwise, any Contribution intentionally submitted for inclusion in the Work by You to the Licensor shall be under the terms and conditions of this License, without any additional terms or conditions. Notwithstanding the above, nothing herein shall supersede or modify the terms of any separate license agreement you may have executed with Licensor regarding such Contributions.
6. **Trademarks.** This License does not grant permission to use the trade names, trademarks, service marks, or product names of the Licensor, except as required for reasonable and customary use in describing the origin of the Work and reproducing the content of the NOTICE file.
7. **Disclaimer of Warranty.** Unless required by applicable law or agreed to in writing, Licensor provides the Work (and each Contributor provides its Contributions) on an "AS IS" BASIS, WITHOUT WARRANTIES OR CONDITIONS OF ANY KIND, either express or implied, including, without limitation, any warranties or conditions of TITLE, NON-INFRINGEMENT, MERCHANTABILITY, or FITNESS FOR A PARTICULAR PURPOSE. You are solely responsible for determining the appropriateness of using or redistributing the Work and assume any risks associated with Your exercise of permissions under this License.
8. **Limitation of Liability.** In no event and under no legal theory, whether in tort (including negligence), contract, or otherwise, unless required by applicable law (such as deliberate and grossly negligent acts) or agreed to in writing, shall any Contributor be liable to You for damages, including any direct, indirect, special, incidental, or consequential damages of any character arising as a result of this License or out of the use or inability to use the Work (including but not limited to damages for loss of goodwill, work stoppage, computer failure or malfunction, or any and all other commercial damages or losses), even if such Contributor has been advised of the possibility of such damages.
9. **Accepting Warranty or Additional Liability.** While redistributing the Work or Derivative Works thereof, You may choose to offer, and charge a fee for, acceptance of support, warranty, indemnity, or other liability obligations and/or rights consistent with this License. However, in accepting such obligations, You may act only on Your own behalf and on Your sole responsibility, not on behalf of any other Contributor, and only if You agree to indemnify, defend, and hold each Contributor harmless for any liability incurred by, or claims asserted against, such Contributor by reason of your accepting any such warranty or additional liability.

END OF TERMS AND CONDITIONS

APPENDIX: How to apply the Apache License to your work.

To apply the Apache License to your work, attach the following boilerplate notice, with the fields enclosed by brackets "[]" replaced with your own identifying information. (Don't include the brackets!) The text should be enclosed in the appropriate comment syntax for the file format. We also recommend that a file or class name and description of purpose be included on the same "printed page" as the copyright notice for easier identification within third-party archives.

Copyright [yyyy] [name of copyright owner]

Licensed under the Apache License, Version 2.0 (the "License"); you may not use this file except in compliance with the License. You may obtain a copy of the License at

<http://www.apache.org/licenses/LICENSE-2.0>

Unless required by applicable law or agreed to in writing, software distributed under the License is distributed on an "AS IS" BASIS, WITHOUT WARRANTIES OR CONDITIONS OF ANY KIND, either express or implied.

See the License for the specific language governing permissions and limitations under the License.

E Conformity declarations

For EU declaration of conformity according to ATEX directive, see document SIFLUXUS.

For the UK declaration of conformity according to the legal UK regulations, see document SI_UKx78xx.

EU declaration of conformity according to low voltage directive

FLEXIM Flexible Industriemesstechnik GmbH

Boxberger Straße 4
12681 Berlin
Germany

declares as manufacturer under its sole responsibility that the ultrasonic flowmeter(s)

FLUXUS a72b**-NN0*c, PIOX S72b**-NN0*c

a = F, G, H

b = 1, 2

c = A, S

complies/comply with the relevant EU regulations and directives, including any amendments valid at the time this declaration was signed. This declaration of conformity is based on the following harmonized EU standards:

EU directive 2014/35/EU (low voltage directive) relating to the making available on the market of electrical equipment designed for use within certain voltage limits

EN 61010-1:2010 Safety requirements for electrical equipment for measurement, control, and laboratory use
Part 1: General requirements

EN 61010-2-030:2010 Safety requirements for electrical equipment for measurement, control, and laboratory use
Part 2-030: Particular requirements for testing and measuring circuits

EU directive 2014/30/EU (EMC directive) relating to electromagnetic compatibility

EN 61326-1:2013 Electrical equipment for measurement, control, and laboratory use – EMC requirements
Part 1: General requirements

EN 55011:2009/A1:2010 Industrial, scientific and medical equipment – Radio-frequency disturbance characteristics –
Limits and methods of measurement

EU directive 2011/65/EU (RoHS directive) on the restriction of the use of certain hazardous substances in electrical and electronic equipment

EN 50581:2012 Technical documentation for the assessment of electrical and electronic products with
respect to the restriction of hazardous substances

FLEXIM GmbH

Signed for and on behalf of

Berlin, 2020-11-30

Place and date



Jens Hilpert
Managing Director

UK declaration of conformity according to UK statutory instruments

FLEXIM Flexible Industriemesstechnik GmbH

Boxberger Straße 4
12681 Berlin
Germany

declares as manufacturer under its sole responsibility that the ultrasonic flowmeter(s)

FLUXUS a72b-NN0*c, PIOX S72b**-NN0*c**

a = F, G, H

b = 1, 2

c = A, S

complies/comply with the relevant UK regulations and legislations, including any amendments valid at the time this declaration was signed. This declaration of conformity is based on the following designated standards:

UK statutory instruments 2016 No.1101 (electrical equipment (safety) regulations) relating to the safety of electrical equipment designed for use within certain voltage limits

EN 61010-1:2010 + A1:2019 Safety requirements for electrical equipment for measurement, control, and laboratory use
+ A1:2019/AC:2019 Part 1: General requirements

EN 61010-2-030:2010 Safety requirements for electrical equipment for measurement, control, and laboratory use
Part 2-030: Particular requirements for testing and measuring circuits

UK statutory instruments 2016 No.1091 (EMC regulations) relating to electromagnetic compatibility

EN 61326-1:2013 Electrical equipment for measurement, control, and laboratory use – EMC requirements
Part 1: General requirements

UK statutory instruments 2012 No.3032 (RoHS regulations) on the restriction of the use of certain hazardous substances in electrical and electronic equipment

EN IEC 63000:2018 Technical documentation for the assessment of electrical and electronic products with respect to the restriction of hazardous substances

FLEXIM GmbH

Signed for and on behalf of

Berlin, 2022-09-01

Place and date



Jens Hilpert
Managing Director

For more information: **Emerson.com**

© 2024 Emerson. All rights reserved.

Emerson Terms and Conditions of Sale are available upon request.
The Emerson logo is a trademark and service mark of Emerson Electric Co. Flexim is a mark of one of the Emerson family of companies. All other marks are the property of their respective owners.