

Operating instruction

FLUXUS F60x



UMFLUXUS_F60xV5-3EN



FLUXUS is a registered trademark of FLEXIM GmbH.

FLEXIM GmbH
Boxberger Straße 4
12681 Berlin
Germany

Tel.: +49 (30) 936 67 660
Fax: +49 (30) 936 67 680
E-mail: info@flexim.com
www.flexim.com

Operating instruction for
FLUXUS F60x
UMFLUXUS_F60xV5-3EN, 2020-05-29
Article number: 21487
Copyright (©) FLEXIM GmbH 2020
Subject to change without prior notice.

Table of contents

- 1 Introduction** 7
- 2 Safety instructions** 9
 - 2.1 General safety instructions 9
 - 2.2 Intended use 9
 - 2.3 Not intended use 10
 - 2.4 Safety instructions for the user 10
 - 2.5 Safety instructions for the operator 10
 - 2.6 Safety instructions for electrical work 11
 - 2.7 Safety instructions for transport 12
 - 2.8 Recommended procedure in hazardous situations 12
- 3 General principles** 13
 - 3.1 Measurement principle 13
 - 3.2 Measurement arrangements 19
 - 3.3 Acoustic penetration 22
 - 3.4 Undisturbed flow profile 24
- 4 Product description** 26
 - 4.1 Measuring system 26
 - 4.2 Handling concept 26
 - 4.3 Navigation 28
 - 4.4 Keyboard 29
- 5 Transport and storage** 31
 - 5.1 Transport 31
 - 5.2 Storage 31
- 6 Installation** 32
 - 6.1 Transmitter 33
 - 6.2 Transducers 36
 - 6.3 Temperature probe 45
- 7 Connection** 50
 - 7.1 FLUXUS *601 50
 - 7.2 FLUXUS *608 67
- 8 Start-up** 82
 - 8.1 Start-up settings 82
 - 8.2 Switching on/off 83

8.3	Program branches	84
8.4	HotCodes	85
8.5	Language	85
8.6	Initialization	86
8.7	Time and date	87
8.8	Instrument information	88
9	Measurement	89
9.1	Parameter input	89
9.2	Measurement settings	97
9.3	Start of the measurement	110
9.4	Display of measured values	115
9.5	Execution of special functions	119
9.6	Determination of the flow direction	120
9.7	Stop of the measurement	120
10	Troubleshooting	121
10.1	Problems with the measurement	122
10.2	Measuring point selection	123
10.3	Maximum acoustic contact	123
10.4	Application-specific problems	124
10.5	Significant deviations of the measured values	124
10.6	Problems with the totalizers	125
10.7	Problems during the heat flow measurement	125
11	Maintenance and cleaning	126
11.1	Maintenance	127
11.2	Cleaning	127
11.3	Calibration	128
12	Dismounting and disposal	129
12.1	Dismounting	129
12.2	Disposal	129
13	Outputs	130
13.1	Installation of an output when using the adapter for the active current input	130
13.2	Installation of a binary output	131
13.3	Configuration of a frequency output as pulse output	134
13.4	Activation of a binary output as pulse output	136

14	Inputs	138
14.1	Assignment of the temperature inputs to the measuring channels	138
14.2	Assignment of other inputs to the measuring channels	140
14.3	Activation of the channels	141
14.4	Temperature correction	142
15	Data logger	145
15.1	Activation/Deactivation of the data logger	145
15.2	Setting the storage rate	146
15.3	Configuration of the data logger	146
15.4	Measurement with activated data logger	149
15.5	Deletion of measured values	149
15.6	Information relating the data logger	149
16	Data transmission	151
16.1	FluxDiagReader/FluxDiag	151
16.2	Terminal program	151
16.3	Transmission parameters	153
16.4	Data format	154
16.5	Data structure	155
17	Advanced functions	157
17.1	Totalizers	157
17.2	NoiseTrek parallel beam mode	160
17.3	HybridTrek mode	160
17.4	Upper limit of the flow velocity	162
17.5	Cut-off flow	163
17.6	Profile correction	164
17.7	Uncorrected flow velocity	165
17.8	FastFood mode	167
17.9	Calculation channels	168
17.10	Diagnosis with the help of the snap function	173
17.11	Modification of the limit for the inner pipe diameter	174
17.12	Transducer temperature	175
17.13	Activation of a binary output as alarm output	175
17.14	Behavior of the alarm outputs	179
18	SuperUser mode	183
18.1	Activation/deactivation	183
18.2	Transducer parameters	184

18.3	Defining flow parameters	184
18.4	Limit of the signal amplification	187
18.5	Upper limit of the sound speed	188
18.6	Detection of long measurement failures	190
18.7	Number of decimal places of the totalizers	190
18.8	Temperature-based thermal energy rate cut-off	191
18.9	Manual reset of the totalizers	192
18.10	Display of the totalizer sum	192
18.11	Display of the last valid measured value	193
18.12	Displays during the measurement	193
19	Settings	194
19.1	Dialogs and menus	194
19.2	Measurement settings	198
19.3	Working with parameter records	201
19.4	Libraries	203
19.5	Contrast settings	206
20	Wall thickness measurement (optional)	207
20.1	Orientation of the wall thickness probe	208
20.2	Activation of the wall thickness measurement	208
20.3	Parameter input	209
20.4	Measurement	210
21	Heat flow measurement	215
21.1	Calculation of the heat flow	216
21.2	Normal measuring mode	217
21.3	BTU mode	220
21.4	Measurement	223
21.5	Two independent heat flow measurements	224
21.6	Steam in inlet	224

Annex

A	Menu structure	227
B	Units of measurement	237
C	Reference	242
D	Conformity declarations	247

1 Introduction

This operating instruction has been written for users operating the ultrasonic flowmeter FLUXUS. It contains important information about the measuring equipment, how to handle it correctly, and how to avoid damages. Read the safety instructions carefully. Make sure you have read and understood this operating instruction before using the measuring equipment.

Any work on the measuring equipment has to be carried out by authorized and qualified personnel in order to detect and avoid possible risks and dangers.

Presentation of warnings

This operating instruction contains warnings marked as follows:

Danger!



Type and source of danger

danger with high level of risk, which if not avoided, can lead to death or serious injuries

→ measures of prevention

Warning!



Type and source of danger

danger with medium level of risk, which if not avoided, can lead to death or serious injuries

→ measures of prevention

Caution!



Type and source of danger

danger with low level of risk, which if not avoided, can lead to minor or moderate injuries

→ measures of prevention

Important!

This text contains important information which should be observed to avoid material damage.

Notice!

This text contains important information about the handling of the measuring equipment.

Storage of the operational manual

The operating instruction must permanently be available at the place where the measuring equipment is used. It must always be available to the user.

User comments

All reasonable effort has been made to ensure the correctness of the content of this operating instruction. If you however find some erroneous information or miss information, please inform us.

We will be grateful for any suggestions and comments regarding the concept and your experience working with the measuring equipment. If you have any suggestions about improving the documentation and particularly this operating instruction, please let us know so that we can consider your comments for future reprints.

Copyright

The contents of this operating instruction are subject to changes without prior notice. All rights reserved. No part of this operating instruction may be reproduced in any form without FLEXIM's written permission.

2 Safety instructions

2.1 General safety instructions

Prior to any work, read the operating instruction carefully and in full.

Failure to comply with the instructions, in particular with the safety instructions, poses a risk to health and can lead to material damages. For further information, contact FLEXIM.

During installation and operation of the measuring equipment, observe the ambient and installation conditions specified in the documentation.

Do not carry out any work on the measuring point during the operation and installation work must be concluded.

The measuring equipment has to be checked for proper condition and operational safety before each use. If troubles or damages have occurred during installation or operation of the measuring equipment, please inform FLEXIM.

It is not allowed to make unauthorized modifications or alterations to the measuring equipment.

The personnel has to be suitably trained and experienced for the work.

If the measuring point is within an explosive atmosphere, the danger zone and present explosive atmosphere have to be determined. The transmitter, transducers and accessories have to be appropriate and approved for the conditions within the corresponding zone.

Observe the "Safety instructions for the use in explosive atmospheres", see document SIFLUXUS_608. Observe the instructions for hazardous substances and the respective safety data sheets. Observe the regulations for the disposal of electrical equipment.

2.2 Intended use

The measuring equipment is intended for the measurement of fluid properties in closed pipes. By means of connected transducers, the transit times of the ultrasonic signals in the fluid and the pipe as well as other related properties, such as temperature and pressure, are measured and evaluated.

The transmitter uses these values to calculate the sought physical quantities, e.g., volumetric flow rate, mass flow rate, thermal energy, density and concentration. Through comparison with the values stored in the transmitter further physical quantities can be determined. The physical quantities are provided via configurable outputs and the display.

- All instructions of this operating instruction have to be observed to ensure intended use.
- Any use beyond or other than the intended use is not covered by warranty and can present a danger. Any damage arising from not intended use shall be solely the liability of the operator or user.
- The measurement is carried out without direct contact to the fluid in the pipe. The flow profile is not influenced.
- The transducers are fixed to the pipe using the supplied transducer mounting fixture.
- Observe the operating conditions, e.g., environment, voltage ranges. For the technical data of the transmitter, transducers and accessories, see technical specification.

2.3 Not intended use

Not intended use in terms of a misuse means:

- any work on the measuring equipment without observing all instructions in this operating instruction
- use of transmitter, transducer and accessories combinations not intended by FLEXIM
- installation of the transmitter, transducers and accessories in explosive atmospheres they are not approved for
- any work on the measuring equipment (e.g., installation, dismantling, connection, start-up, operation, service and maintenance) carried out by unauthorized and untrained personnel
- storage, installation and operation of the measuring equipment outside the specified ambient conditions, see technical specification

2.4 Safety instructions for the user

Any work on the transmitter has to be carried out by authorized and qualified personnel. Observe the safety instructions in the operating instruction. For the technical data of the transmitter, transducers and accessories, see technical specification.

- Observe the safety and accident prevention regulations applicable on the site of operation.
- Only use the supplied mounting fixtures and transducers as well as the intended accessories.
- Always wear the required personal protective equipment.

2.5 Safety instructions for the operator

- The operator shall qualify the personnel to perform their assigned tasks. The operator shall provide the required personal protective equipment and oblige the personnel to wear it. It is recommended to risk assess the workplace.
- Besides the safety instructions in this operating instruction, the health, safety and environment regulations applicable for the range of application of the transmitter, transducers and accessories have to be observed.
- With the exceptions stated in chapter 11, the measuring equipment is maintenance-free. Any components and spare parts may only be replaced by FLEXIM. The operator shall carry out periodic checks for changes or damages that can present a danger. For further information, contact FLEXIM.
- Observe the specifications for the installation and connection of the transmitter, transducers and accessories, see chapter 6 and 7.

2.6 Safety instructions for electrical work

- Electrical work may only be carried out if there is enough space.
- The degree of protection of the transmitter is only ensured if all unused connections are covered.
- Housing protection of measuring equipment or accessories with cable glands is only given if cable glands are firmly tighten and all cables fit tightly.
- The condition and tight fit of the electrical connections have to be checked at regular intervals.
- The power supply unit for charging the battery may only be connected to networks up to overvoltage category II. Use only the supplied power supply unit. For the power supply via power cable and power adapter, observe the safety instructions in chapter 7, sections 7.1.2 (FLUXUS *601) and 7.2.2 (FLUXUS *608).
- The transmitter and the power supply unit must not be disassembled, see Fig. 2.1. The transmitter does not contain any components to be maintained by the user. For repair and service work, please contact FLEXIM.
- Observe the safety and accident prevention regulations for electrical systems and equipment.

Fig. 2.1: Transmitter



2.7 Safety instructions for transport

- If you detect a transport damage when unpacking the delivery, please contact the supplier or FLEXIM immediately.
- The transmitter is a sensitive electronic measuring instrument. Avoid shocks or impacts.
- Handle the transducer cable with care. Avoid excessive bending or buckling. Observe the ambient conditions.
- Select a solid surface to put the transmitter, transducers and accessories on.
- The transmitter, transducers and accessories have to be properly packed for transport:
 - Use, if possible, the original packaging by FLEXIM or an equivalent cardboard box.
 - Position the transmitter, transducers and accessories in the middle of the cardboard box.
 - Fill any voids with appropriate packaging material (e.g., paper, foam, bubble wrap).
 - Protect the cardboard box against humidity.

2.8 Recommended procedure in hazardous situations

Fire fighting measures

- If possible, disconnect the transmitter from the power supply.
- Prior to extinguishing, protect any electrical parts that are not affected by the fire (e.g., using a cover).
- Select a suitable extinguishing agent. Avoid, if possible, conductive extinguishing agents.
- Observe the applicable minimum distances. The minimum distances differ depending on the used extinguishing agent.

3 General principles

In the ultrasonic flow measurement, the flow velocity of the fluid in a pipe is determined. Further physical quantities are derived from the flow velocity and from additional physical quantities, if necessary.

3.1 Measurement principle

The flow velocity of the fluid is measured in the TransitTime mode using the ultrasonic-transit time difference correlation principle. When measuring with a high proportion of gas or solid particles, the transmitter can toggle into the NoiseTrek mode.

3.1.1 Terms

Flow profile

Distribution of flow velocities over the cross-sectional pipe area. For an optimal measurement, the flow profile has to be fully developed and axisymmetrical. The shape of the flow profile depends on whether the flow is laminar or turbulent and is influenced by the conditions at the inlet of the measuring point.

Reynolds number Re

Coefficient describing the turbulence behavior of a fluid in the pipe. The Reynolds number Re is calculated from the flow velocity, the kinematic viscosity of the fluid and the inner pipe diameter.

If the Reynolds number exceeds a critical value (usually approx. 2300, if the fluid flows in a pipe), a transition from a laminar flow to a turbulent flow takes place.

Laminar flow

A flow without any turbulence. There is no mixing between the parallel flowing layers of the fluid.

Turbulent flow

A flow with turbulences (swirling of the fluid). In technical applications, the flow in the pipe is mostly turbulent.

Transition range

The flow is partly laminar and partly turbulent.

Sound speed c

Speed of the propagating sound. The sound speed depends on the mechanical properties of the fluid or the pipe material. In pipe materials and other solid materials, a distinction is made between the longitudinal and transversal sound speed. For the sound speed of some fluids and materials, see annex C.

Flow velocity v

Average value of all flow velocities of the fluid over the cross-sectional pipe area.

Acoustic calibration factor k_a

$$k_a = \frac{c_\alpha}{\sin \alpha}$$

The acoustic calibration factor k_a is a transducer parameter which results from the sound speed c within the transducer and the angle of incidence. According to Snell's law of refraction, the angle of propagation in the adjoining fluid or pipe material is:

$$k_a = \frac{c_\alpha}{\sin \alpha} = \frac{c_\beta}{\sin \beta} = \frac{c_\gamma}{\sin \gamma}$$

Fluid mechanics correction factor k_{Re}

With the fluid mechanics calibration factor k_{Re} , the measured value of the flow velocity in the area of the sound beam is converted into the value of the flow velocity across the whole cross-sectional pipe area. In case of a fully developed flow profile, the fluid mechanics calibration factor only depends on the Reynolds number and the roughness of the inner pipe wall. The fluid mechanics calibration factor is recalculated by the transmitter for each new measurement.

Volumetric flow rate \dot{V}

$$\dot{V} = v \cdot A$$

The volume of the fluid that passes through the pipe per unit time. The volumetric flow rate is calculated from the product of the flow velocity v and the cross-sectional pipe area A .

Mass flow rate \dot{m}

$$\dot{m} = \dot{V} \cdot \rho$$

The mass of the fluid that passes through the pipe per unit time. The mass flow rate is calculated from the product of the volumetric flow rate \dot{V} and the density ρ .

Heat flow Φ

The heat quantity that is transferred per unit time. For the calculation of the heat flow see chapter 21.

3.1.2 Measurement of the flow velocity in the TransitTime mode

The signals are emitted and received by 2 transducers alternatively in and against the flow direction. If the fluid is flowing, the signals propagating in the fluid are displaced with the flow.

Caused by this displacement, the sound path of the signal in flow direction is reduced and the signal against the flow direction is increased, see Fig. 3.1 and Fig. 3.2.

This causes a change in the transit times. The transit time of the signal in flow direction is shorter than the transit time against the flow direction. The transit time difference is proportional to the average flow velocity.

The average flow velocity of the fluid is calculated as follows:

$$v = k_{Re} \cdot k_a \cdot \frac{\Delta t}{2 \cdot t_y}$$

where

- v – average flow velocity of the fluid
- k_{Re} – fluid mechanics calibration factor
- k_a – acoustic calibration factor
- Δt – transit time difference
- t_y – transit time in the fluid

Fig. 3.1: Sound path of the signal in the flow direction

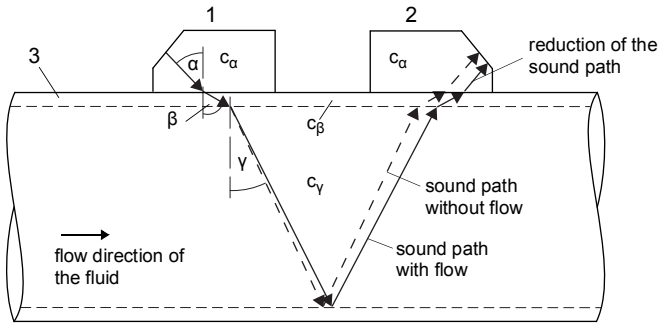

- c – sound speed
- 1 – transducer (emitter)
- 2 – transducer (receiver)
- 3 – pipe wall

Fig. 3.2: Sound path of the signal against the flow direction

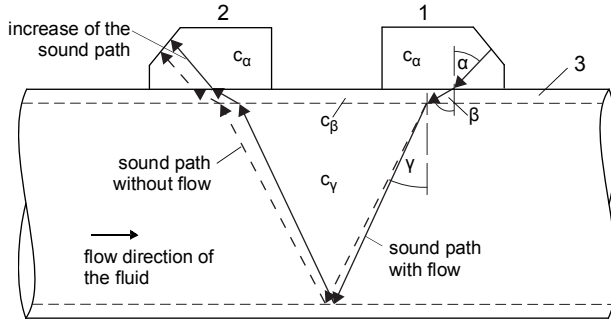

- c – sound speed
- 1 – transducer (emitter)
- 2 – transducer (receiver)
- 3 – pipe wall

Fig. 3.3: Transit time difference Δt

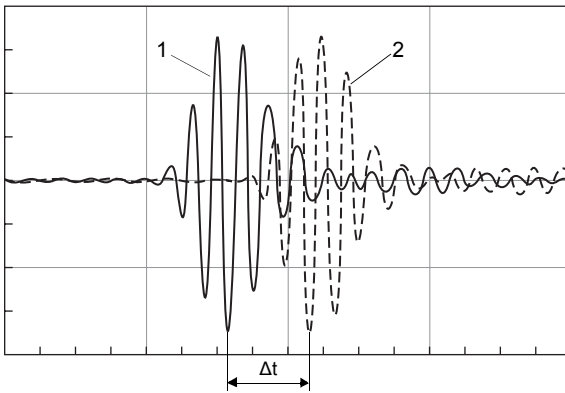

- 1 – signal in the flow direction
- 2 – signal against the flow direction

3.1.3 Measurement of the flow velocity in the NoiseTrek mode

If the proportion of gas or solids in the fluid is high, the damping of the ultrasonic signal can be so high that the complete propagation of the fluid and therefore a measurement in TransitTime mode is not possible anymore. In this case the NoiseTrek mode has to be used.

The NoiseTrek mode uses the presence of gas bubbles and/or solid particles in the fluid. Ultrasonic signals are sent from a transducer into the fluid at short intervals, reflected by the gas bubbles and/or the solids particles and again received by the same transducer.

The measurement arrangement used in the TransitTime mode does not need to be changed.

The transit time difference Δt of 2 consecutive ultrasonic signals is determined. It behaves proportionately to the distance the gas bubble/solid particle is covering between 2 consecutive pulses and thus, to the average flow velocity of the fluid, see Fig. 3.4.

Fig. 3.4: Measurement of the flow velocity in the NoiseTrek mode

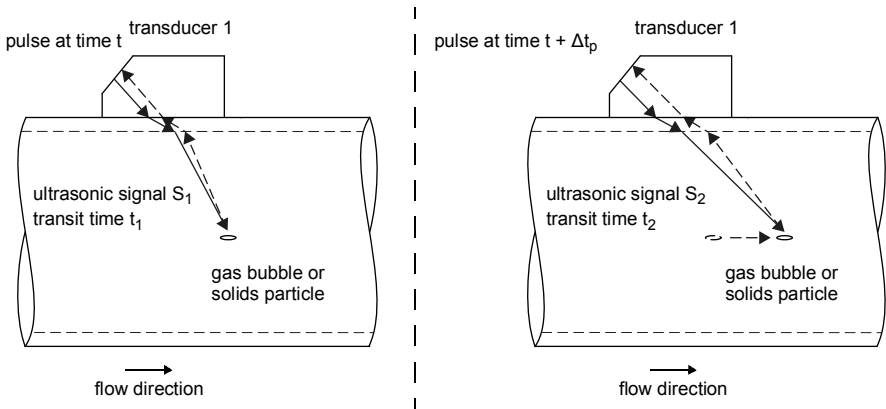

The average flow velocity of the fluid is calculated as follows:

$$v = k_{Re} \cdot k_a \cdot \frac{\Delta t}{2 \cdot \Delta t_p}$$

where

v – average flow velocity of the fluid

k_{Re} – fluid mechanics calibration factor

k_a – acoustic calibration factor

Δt_p – time difference between 2 consecutive pulses

Δt – transit time difference of ultrasonic signals S_1 and S_2 ($\Delta t = t_2 - t_1$)

Depending on the attenuation of the ultrasonic signal, the error of measurement in the NoiseTrek mode can be greater than in the TransitTime mode.

3.1.4 Measurement of the flow velocity in the HybridTrek mode

The HybridTrek mode combines the TransitTime and the NoiseTrek mode. During a measurement in the HybridTrek mode, the transmitter automatically toggles between the TransitTime and the NoiseTrek mode depending on the gaseous or solid content. The measurement arrangement is identical to the one in the TransitTime mode.

3.1.5 Measurement of the flow velocity in the NoiseTrek parallel beam mode

Pipes with a small pipe diameter or fluids which strongly attenuate the ultrasonic signal can cause a reduction of the transit time in the fluid with the result that the signal quality is no longer sufficient. In this case the NoiseTrek parallel beam mode has to be used.

The NoiseTrek parallel beam mode works the same way the NoiseTrek mode does, the only difference is that the sending and receiving process do not occur in the same transducer. This leads to a better signal quality. The transducers are mounted in parallel on the pipe at a small distance, see Fig. 3.5. A measurement in TransitTime mode is not possible when working with this measurement arrangement.

Fig. 3.5: Measurement arrangement in the NoiseTrek parallel beam mode

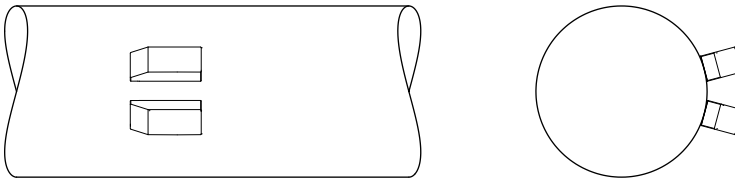

3.2 Measurement arrangements

3.2.1 Terms

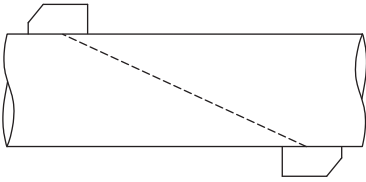
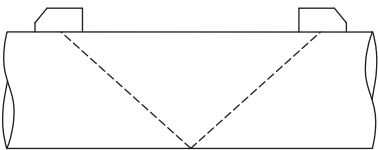
diagonal arrangement	reflection arrangement
The transducers are mounted on opposite sides of the pipe.	The transducers are mounted on the same side of the pipe.
	

Sound path

The distance covered by the ultrasonic signal after crossing the pipe once. The number of the sound paths is:

- odd if the measurement is carried out in diagonal arrangement
- even if the measurement is carried out in reflection arrangement

Beam

The path covered by the ultrasonic signal between the transducers, i.e., the transducer emitting the ultrasonic signal and the transducer receiving it. One beam consists of 1 or several sound paths.

Fig. 3.6: Diagonal arrangement with 2 beams and 3 sound paths

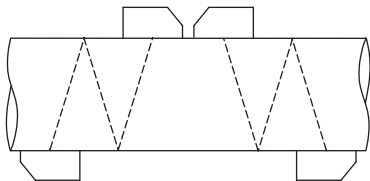
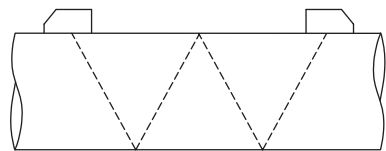
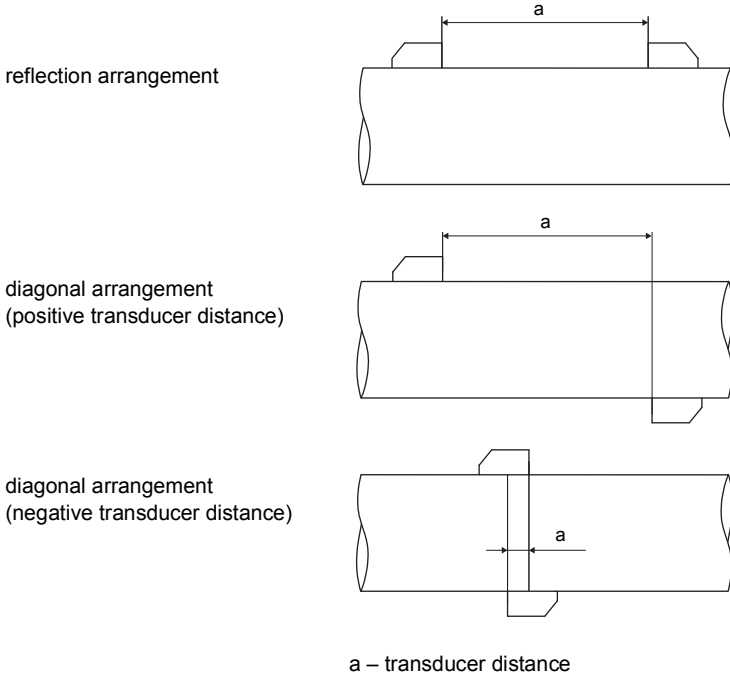

Fig. 3.7: Reflection arrangement with 1 beam and 4 sound paths



Transducer distance

The transducer distance is measured between the inner edges of the transducers.



Sound beam plane

Plane containing 1 or several sound paths or beams

Fig. 3.8: 2 beams in 1 plane

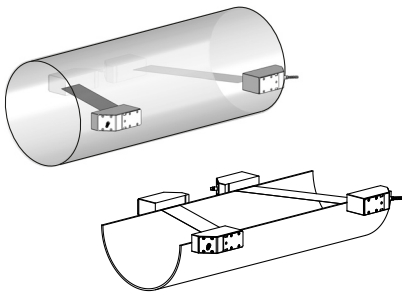
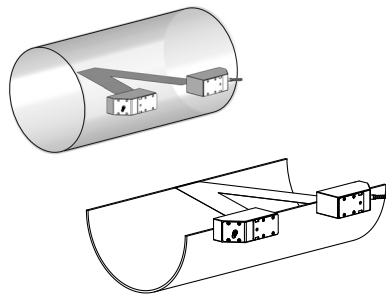
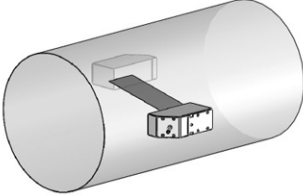
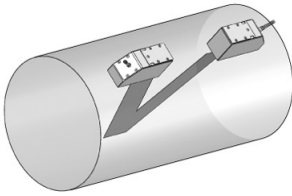
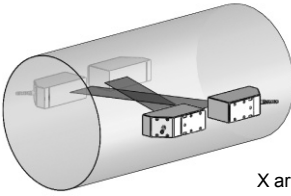
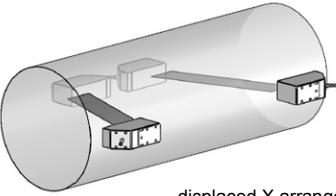
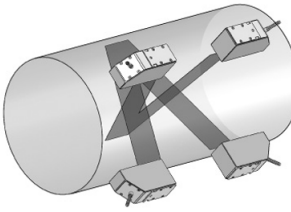

Fig. 3.9: 2 sound paths in 1 plane



3.2.2 Examples

diagonal arrangement with 1 beam	reflection arrangement with 1 beam
<p>1 transducer pair 1 sound path 1 beam 1 plane</p> 	<p>1 transducer pair 2 sound paths 1 beam 1 plane</p> 
diagonal arrangement with 2 beams	reflection arrangement with 2 beams and 2 planes
<p>2 transducer pairs 2 sound paths 2 beams 1 plane</p>  <p style="text-align: right;">X arrangement</p>  <p style="text-align: right;">displaced X arrangement</p>	<p>2 transducer pairs 4 sound paths 2 beams 2 planes</p> 

3.3 Acoustic penetration

The pipe has to be acoustically penetrable at the measuring point. The acoustic penetration is given when pipe and fluid do not attenuate the sound signal so strongly that it is completely absorbed before reaching the second transducer.

The attenuation caused by the pipe and the fluid depends on:

- kinematic viscosity of the fluid
- proportion of gas bubbles and solids in the fluid
- deposits on the inner pipe wall
- pipe material

The following requirements have to be met at the measuring point:

- the pipe is always completely filled
- no solid deposits in the pipe
- no bubble formation in the pipe

Notice!

Even bubble-free fluids can form gas bubbles when the fluid expands, e.g., before pumps and after great cross-section extensions.

Observe the following notes on the selection of the measuring point:

Horizontal pipe

Select a measuring point where the transducers can be mounted laterally on the pipe, allowing the sound waves to propagate horizontally in the pipe. Thus, solids on the bottom of the pipe or gas bubbles in the pipe's upper part are prevented from influencing the propagation of the signal, see Fig. 3.10 and Fig. 3.11.

Fig. 3.10: Recommended transducer mounting position

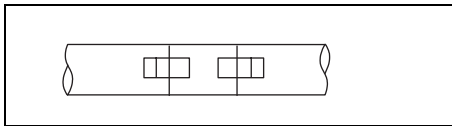
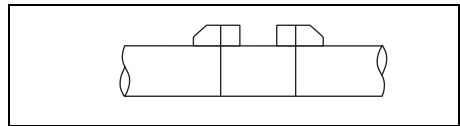

Fig. 3.11: Disadvantageous transducer mounting position



Vertical pipe

Select the measuring point at a pipe location where the fluid flows upward. The pipe has to be completely filled, see Fig. 3.12 and Fig. 3.13.

Fig. 3.12: Recommended transducer mounting position

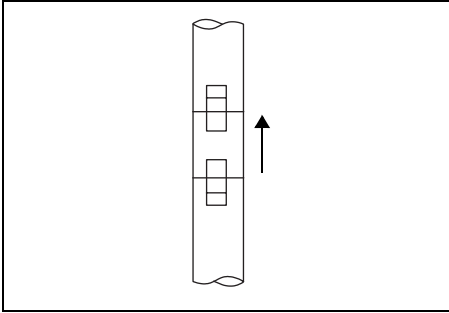
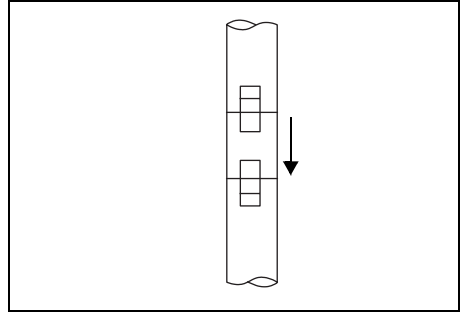

Fig. 3.13: Disadvantageous transducer mounting position



Free inlet or outlet pipe section

Select the measuring point at a pipe section where the pipe cannot run empty, see Fig. 3.14 and Fig. 3.15.

Fig. 3.14: Recommended transducer mounting position

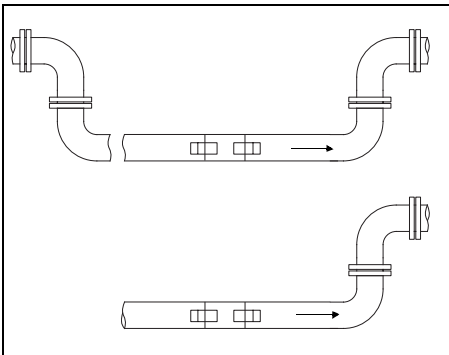
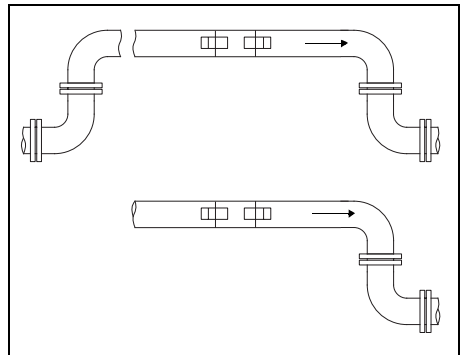

Fig. 3.15: Disadvantageous transducer mounting position



3.4 Undisturbed flow profile

Some flow elements (e.g., elbows, valves, pumps, reducers) distort the flow profile in their vicinity. The axisymmetrical flow profile in the pipe needed for correct measurement is no longer given. A careful selection of the measuring point helps to reduce the impact of disturbance sources.

It is most important that the measuring point is chosen at a sufficient distance from any disturbance sources. Only then it can be assumed that the flow profile in the pipe is fully developed. However, measuring results can be obtained even if the recommended distance to disturbance sources cannot be met for practical reasons.

The recommended straight inlet and outlet pipe lengths for different types of flow disturbance sources are shown in the examples in Tab. 3.1.

Tab. 3.1: Recommended distance from disturbance sources
D – nominal pipe diameter at the measuring point
l – recommended distance between disturbance source and transducer position

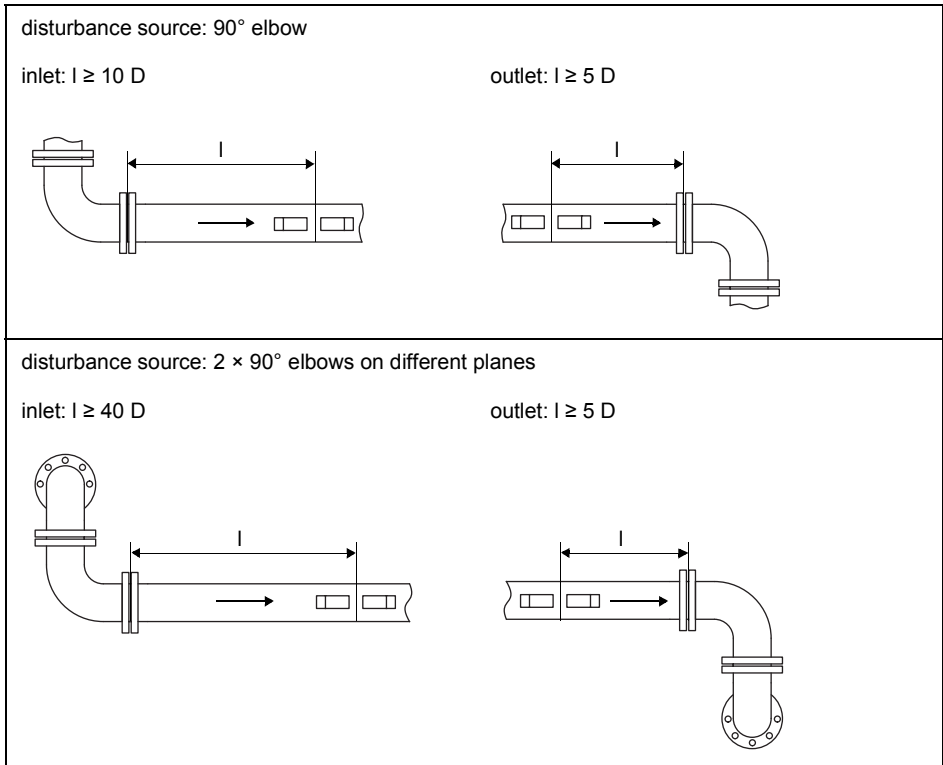

Tab. 3.1: Recommended distance from disturbance sources

D – nominal pipe diameter at the measuring point

l – recommended distance between disturbance source and transducer position

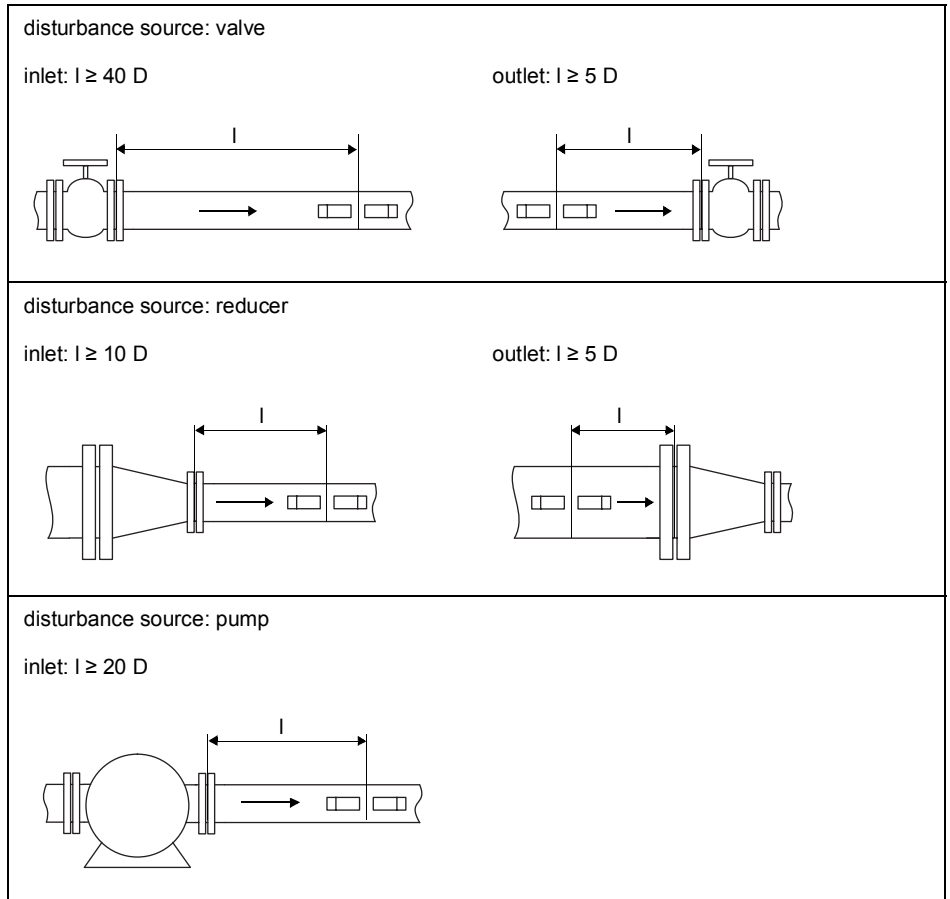

4 Product description

4.1 Measuring system

The measurement system consists of a transmitter, the ultrasonic transducers and the pipe on which the measurement is carried out, see Fig. 4.1.

Fig. 4.1: Example for a measurement arrangement

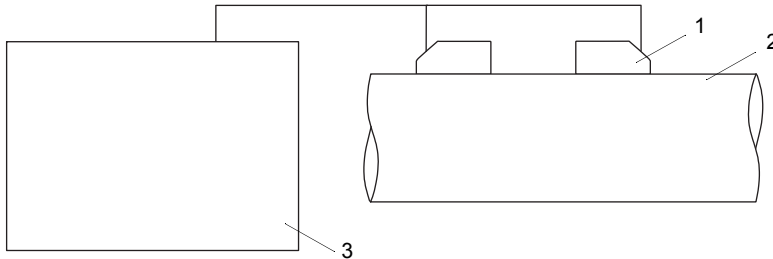

- 1 – transducer
- 2 – pipe
- 3 – transmitter

The ultrasonic transducers are mounted on the pipe. They send and receive ultrasonic signals through the fluid.

The transmitter controls the measuring cycle, eliminates noise signals and analyzes useful signals. The measured values can be displayed, used for calculations and transmitted by the transmitter.

4.2 Handling concept

The transmitter is operated via the keyboard.

The selected program branch is displayed in angle brackets and capital letters, see Fig. 4.2. The complete name of the selected program branch is displayed in the lower line.

Select a program branch with key `<4>` and `<6>`. Press ENTER.

- par (Parameter)
- mea (Measuring)
- opt (Output Options)
- sf (Special Funct.)

Fig. 4.2: Command panel of the transmitter

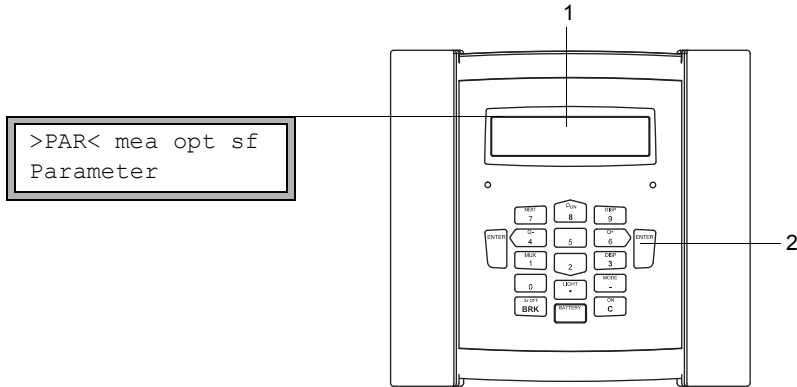

- 1 – display
- 2 – keyboard

For a description of the individual program branches, see Tab. 4.1.

Tab. 4.1: Description of the program branches

program branch	description
Parameter	Before starting a measurement, the transducer, pipe and fluid parameters have to be entered in the program branch <code>Parameter</code> .
Measuring	After activating the measuring channels and the input of the transducer distance, the measurement is started in the program branch <code>Measuring</code> .
Output Options	Channel-related settings such as determination of the physical quantity, unit of measurement and parameters for the transmission of measured values are set in the program branch <code>Output Options</code> .
Special Funct.	Includes global settings which are not directly related to the measurement.

4.3 Navigation

4.3.1 Scroll lists

If a vertical arrow \updownarrow is displayed, the menu item contains a scroll list. The current list item is displayed in the lower line.

```
Parameter       $\updownarrow$ 
for Channel A:
```

- Press key \leftarrow 8 and \rightarrow 2 to scroll and select a list item in the lower line.
- Press ENTER.

Some menu item contain a horizontal scroll list in the lower line. The selected list item is displayed in angle brackets and capital letters.

```
Lining
no          YES
```

- Press key \leftarrow 4 and \rightarrow 6 to scroll and select a list item in the lower line.
- Press ENTER.

Some menu items contain a horizontal scroll list in the upper line. The selected list item is displayed in angle brackets and capital letters. The current value of the list item is displayed in the lower line.

```
R1=FUNC< typ mode
Function      MAX
```

- Press key \leftarrow 4 and \rightarrow 6 to scroll and select a list item in the upper line.
- Press key \leftarrow 8 and \rightarrow 2 to scroll and to select a value for the selected list item in the lower line.
- Press ENTER.

4.3.2 Input fields

```
OUTER DIAMETER
100.0      mm
```

- Enter a value via the numerical keys of the keyboard, see Tab. 4.4.
- Press ENTER.

4.4 Keyboard





The keyboard has 15 keys, including 3 function keys: ENTER, BRK and C.

Some key have multiple functions. They can be used to enter data, to navigate through scroll lists as well as to execute special functions (e.g., reset of totalizers).



Tab. 4.2: General functions

C	switching on the transmitter
LIGHT	switching on/off the display backlight
ENTER	confirmation of selection or input
BRK + C + ENTER	Reset: press these 3 keys simultaneously to correct a malfunction. The reset has the same effect as a restart of the transmitter. Stored data are not affected.
BRK	interruption of the measurement and selection of the main menu Be careful not to stop a current measurement by inadvertently pressing key BRK.
BRK	switching off the transmitter by pressing key BRK 3 times











Tab. 4.3: Navigation

BRK	selection of the main menu
 	scroll to the left/right through a scroll list
 	scroll upwards/downwards through a scroll list
ENTER	confirmation of a menu item of the program branch

Tab. 4.4: Input of numbers

	input of the number pictured on the key
	sign for the input of negative values
	decimal marker
C	deletion of values After the value has been deleted, the previous value will be displayed.
ENTER	confirmation of the input

Tab. 4.5: Input of text

 	positioning of the cursor
	"A" is displayed and capitalization is activated
	"Z" is displayed and capitalization is activated
	toggling between upper and lower case
 	selection of the previous/next character
	deletion of a character and insertion of a blank
 	Automatic scrolling up or down through the limited ASCII character set. The character changes every second. The scrolling is stopped by pressing any other key.
ENTER	confirmation of the input

5 Transport and storage

Caution!



When packaging, the transmitter can fall down.

There is a danger of crushing body parts or damaging the measuring equipment.

- Secure the transmitter against falling during packaging.
- Wear the required personal protective equipment.
- Observe the applicable rules.

Caution!



When lifting, the center of gravity of the transmitter can be displaced within the cardboard box. The transmitter can fall down.

There is a danger of crushing body parts or damaging the measuring equipment.

- Secure the transmitter against falling during transport.
- Wear the required personal protective equipment.
- Observe the applicable rules.

5.1 Transport

The measuring equipment must be packaged properly for transport, see section 2.7. For weight indications of the transmitter and the transducers, see technical specification.

5.2 Storage

The transmitter and the transducers have to be stored in a dry place.

6 Installation

Danger!



Risk of explosion when using the measuring instrument in explosive atmospheres (ATEX, IECEx)

This may result in personal or material damage or other dangerous situations.

- Observe the "Safety instructions for the use in explosive atmospheres", see document SIFLUXUS_608.

Danger!



Risk of explosion when using the measuring instrument FLUXUS *608-F2 in explosive atmospheres**

This may result in personal or material damage or other dangerous situations.

- Observe the "Safety instructions for the use in explosive atmospheres", see document SIFLUXUS_608F2.

Caution!



Touching hot or cold surfaces

This may result in injuries (e.g., thermal damages).

- Observe the ambient conditions at the measuring point during installation.
- Wear the required personal protective equipment.
- Observe the applicable rules.

6.1 Transmitter

6.1.1 Transmitter structure

Fig. 6.1: Command panel of the transmitter

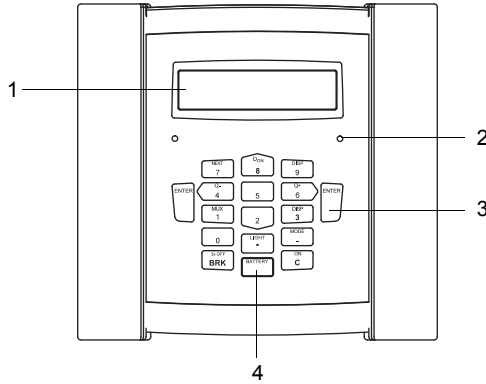

- 1 – display, 2 × 16-digit (backlight)
- 2 – status indication "SIGNAL"
- 3 – keyboard
- 4 – state indicator "BATTERY"

A handle is mounted on the rear side of the transmitter, see Fig. 6.2. The handle can also be used as support. The opening in the support plate is used to fasten the transmitter to the pipe, see section 6.1.2.3.

Fig. 6.2: Rear side of the transmitter

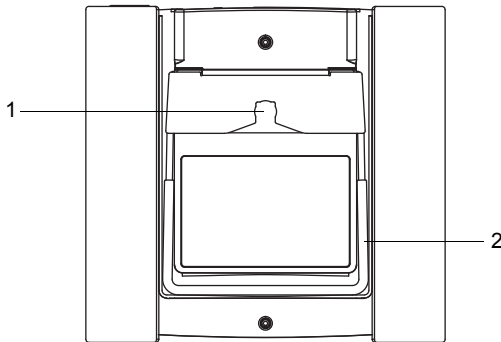

- 1 – opening in the support plate for button
- 2 – handle/support

6.1.2 Installation of the transmitter

6.1.2.1 Placement

Pull the support back to the stop of the support plate, see Fig. 6.3.

Fig. 6.3: Placement of the transmitter

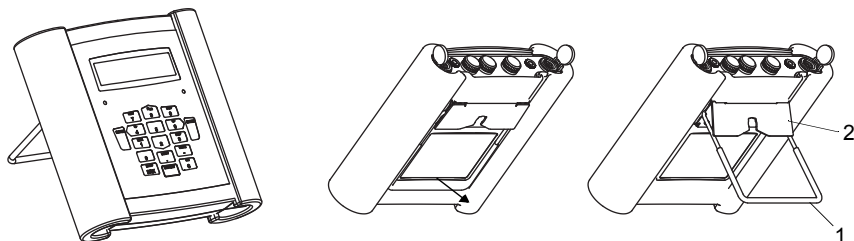

- 1 – handle
- 2 – support plate

6.1.2.2 Suspension

Press both ends of the handle outwards and pass them past the support plate. Turn the handle upwards.

Fig. 6.4: Suspension of the transmitter

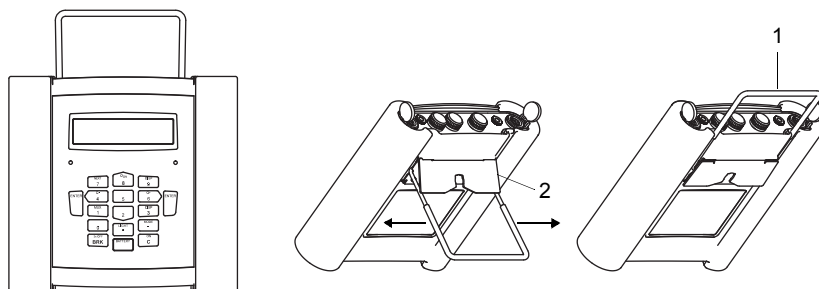

- 1 – handle
- 2 – support plate

6.1.2.3 Pipe installation

Important!

The pipe temperature must not exceed the operating temperature of the transmitter.

Fix the tension belt with the button to the pipe. Tighten the belt using the ratchet. Insert the button into the opening in the support plate on the rear side of the transmitter, see Fig. 6.5 and Fig. 6.6.

Fig. 6.5: Pipe installation



- 1 – ratchet
- 2 – button on the pipe
- 3 – opening in the support plate

Fig. 6.6: Transmitter on the pipe

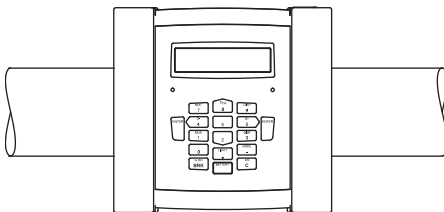

6.2 Transducers

6.2.1 Preparation

6.2.1.1 Measuring point selection

The correct selection of the measuring point is crucial for achieving reliable measurement results and a high measurement accuracy.

A measurement on a pipe is possible if:

- the ultrasound propagates with a sufficiently high amplitude
- the flow profile is fully developed

The correct selection of the measuring point and the correct transducer positioning guarantee that the sound signal will be received under optimum conditions and evaluated correctly.

Because of the variety of applications and the different factors that influence the measurement, there is no standard solution for the transducer positioning.

The measurement is influenced by the following factors:

- diameter, material, lining, wall thickness and shape of the pipe
- fluid
- gas bubbles in the fluid
- Avoid measuring points in the vicinity of distorted or defective areas of the pipe or in the vicinity of welds.
- Avoid measuring points with deposit formation in the pipe.
- Make sure the pipe surface at the selected measuring point is even.
- Select the location of the transmitter within the transducer cable range.
- The ambient temperature at the measuring point has to be within the operating temperature range of the transmitter and the transducers, see technical specification.

If the measuring point is within an explosive atmosphere, possibly present danger zones and gases have to be determined. The transducers and the transmitter have to be appropriate for these conditions.

6.2.1.2 Pipe preparation

Caution!



Contact with grinding dust

This may result in injuries (e.g., breathing difficulties, skin reactions, eye irritations).

- Wear the required personal protective equipment.
- Observe the applicable rules.

Important!

The pipe has to be sufficiently stable to withstand the pressure exerted by the transducers and the tension straps.

Notice!

Observe the selection criteria of pipe and measuring point.

Rust, paint or deposits on the pipe absorb the sound signal. A good acoustic contact between the pipe and the transducers is obtained as follows:

- Clean the pipe at the selected measuring point.
 - If present, the paint layer has to be smoothed by grinding. The paint does not need to be removed completely.
 - Remove rust or loose paint.
- Use coupling foil or apply a bead of acoustic coupling compound along the center line of the contact surface of the transducers.
- Observe that there must be no air pockets between the transducer contact surface and the pipe wall.

6.2.1.3 Selection of the measurement arrangement

Diagonal arrangement with 1 beam

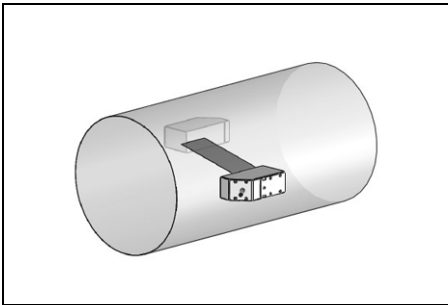

- wider flow velocity and sound speed range compared to the reflection arrangement
- use in the presence of deposits on the inner pipe wall or with strongly attenuating gases or liquids (only 1 sound path)

Reflection arrangement with 1 beam

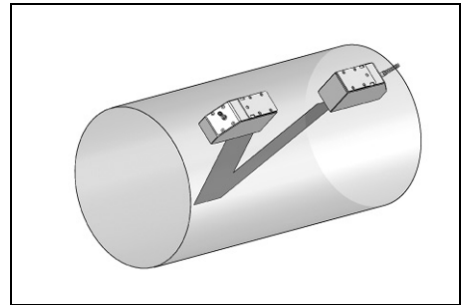

- smaller flow velocity and sound speed range compared to the diagonal arrangement
- transverse flow effects are compensated because the beam crosses the pipe in 2 directions
- higher accuracy of measurement because the accuracy increases with the number of sound paths

Diagonal arrangement with 2 beams

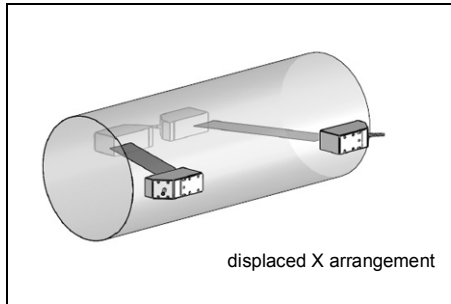
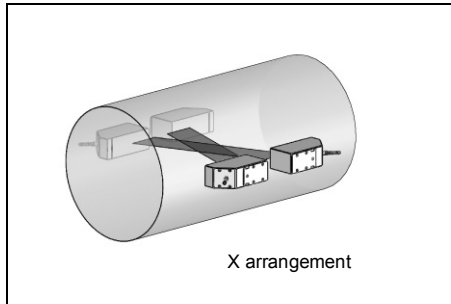

- same characteristics as diagonal arrangement with 1 beam
- additional characteristic:
transverse flow effects are compensated because the measurement is conducted with 2 beams

Reflection arrangement with 2 beams and 2 planes

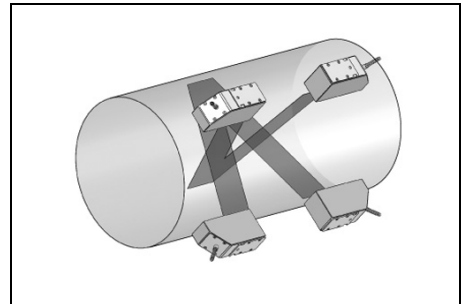

- same characteristics as reflection arrangement with 1 beam
- additional characteristic:
influences of the flow profile are compensated because the measurement takes place in 2 planes

If the measuring point is situated near an elbow, the following measurement arrangements are recommended for the selection of the sound beam plane.

Vertical pipes

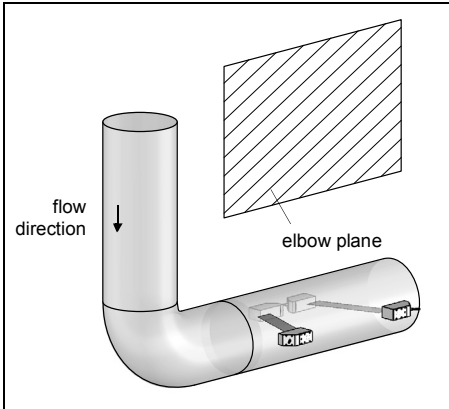

- The sound beam plane is selected in an angle of 90° to the elbow plane. The elbow is upstream of the measuring point.

Horizontal pipes

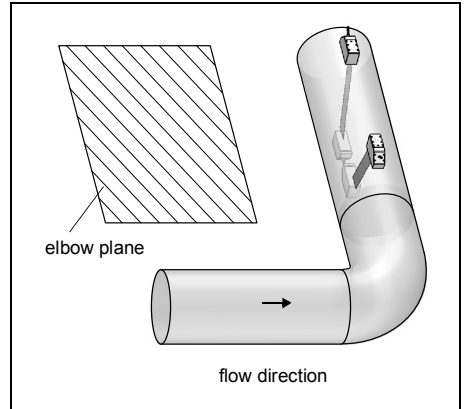

- The sound beam plane is selected in an angle of 90° ± 45° to the elbow plane. The elbow is upstream of the measuring point.

Bidirectional measurements

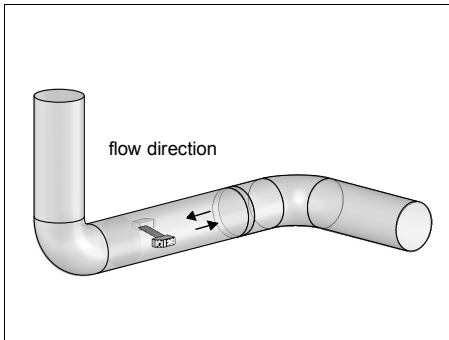

- The sound beam plane is selected according to the nearest elbow (horizontal or vertical, depending on the pipe orientation, see above).

Measurements in reflection arrangement with 2 beams and 2 planes

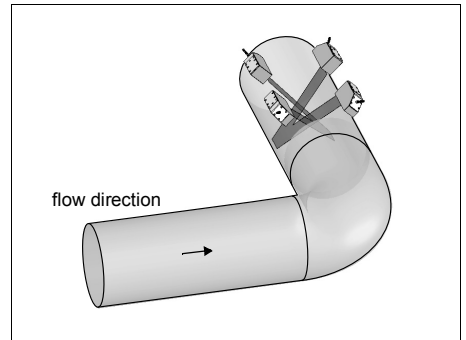

- The 2 sound beam planes are selected in an angle of 45° to the elbow plane. The elbow is upstream of the measuring point.
- On horizontal pipes, the transducers are mounted on the upper half of the pipe.

6.2.2 Installation of the transducers

Important!

Handle the transducers with care. Do not let the transducers hang on their cables.

Important!

Handle the cables with care. Avoid excessive bending or buckling, especially at simultaneous strain.

6.2.2.1 Orientation of the transducers and determination of the transducer distance

Observe the orientation of the transducers. If the transducers have been mounted properly, the engravings on the transducers form an arrow, see Fig. 6.7. The transducer cables show in opposite directions.

The transducer distance is measured between the inner edges of the transducers.

Fig. 6.7: Orientation of the transducers and transducer distance

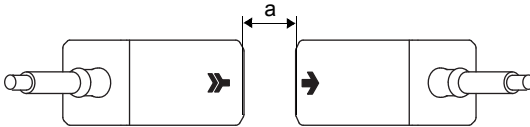

a – transducer distance

- Select the installation instructions that correspond to the supplied transducer mounting fixture.

6.2.2.2 Transducer arrangement

The transducer mounting with mounting rails can have various arrangements:

Fig. 6.8: Transducer arrangement in mounting rails

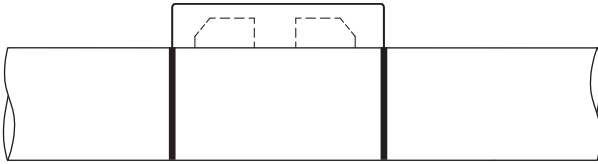

reflection arrangement,
1 rail

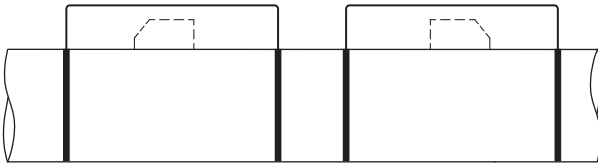

reflection arrangement,
2 rails

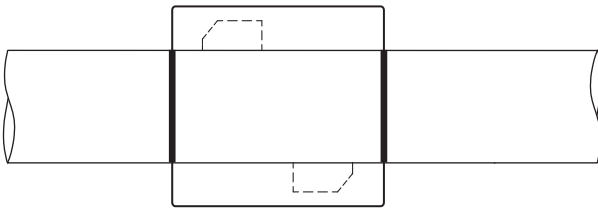

diagonal arrangement,
2 parallel rails

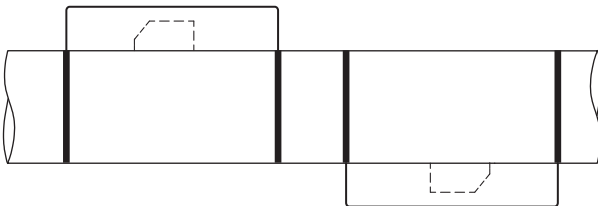

diagonal arrangement,
2 displaced rails

6.2.2.3 Installation of transducers with fastening shoes and chains

- Insert the transducers into the fastening shoes.
- Turn the screw on the upper side of the fastening shoes by 90° in order to engage and lock its extremity in the groove on top of the inserted transducer.
- Insert the ruler into the lateral slot of the fastening shoes.
- Adjust the displayed transducer distance, see section 9.3.
- Fix the transducers with the plastic screws on the transducer cable side of the fastening shoes.
- Place the fastening shoes/ruler assembly on the pipe at the measuring point.
- Insert the last ball into the slot on the upper side of one of the fastening shoe.
- Place the chain around the pipe.
- Tighten the chain and insert it into the other slot of the fastening shoe.

Fig. 6.9: Installation of the transducers with fastening shoes and chains

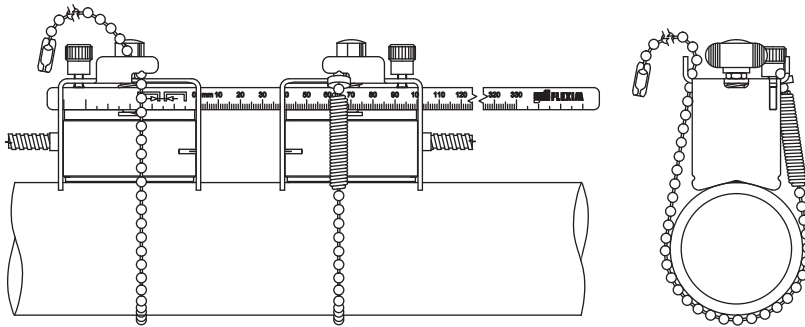

Extension of the ball chain

In order to extend the chain, insert the last ball of the extension into the fastening clip of the ball chain. The spare fastening clips supplied with the chain can be used to repair a broken chain.

Notice!

When using fastening shoes, the reflection arrangement is to be preferred. The ruler can be used as mounting aid.

In case the mounting has to be carried out in diagonal arrangement (without ruler), contact FLEXIM for further support.

6.2.2.4 Installation of the transducers with magnetic fastening shoes

- Insert the transducers into the fastening shoes.
- Turn the screw on the upper side of the fastening shoes by 90° in order to engage and lock its extremity in the groove on top of the inserted transducer.
- Apply some coupling compound to the contact surface of the transducers.
- Insert the ruler into the lateral slot of the fastening shoes.
- Adjust the displayed transducer distance, see section 9.3.
- Fix the transducers with the plastic screws on the transducer cable side of the fastening shoes.
- Place the fastening shoes/ruler assembly on the pipe at the measuring point. There must be no air pockets between pipe wall and contact surface of the transducer.

Fig. 6.10: Installation of the transducers with magnetic fastening shoes

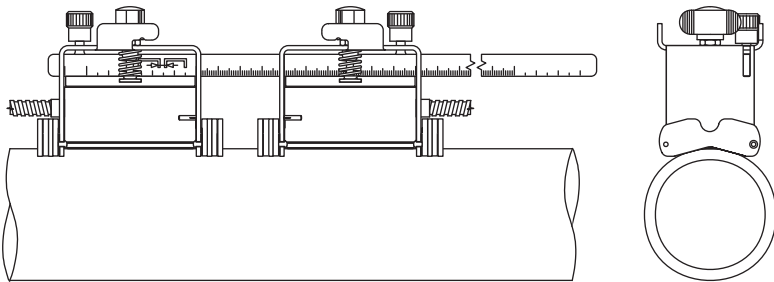

Notice!

When using fastening shoes, the reflection arrangement is to be preferred. The ruler can be used as mounting aid.

In case the mounting has to be carried out in diagonal arrangement (without ruler), contact FLEXIM for further support.

6.2.2.5 Installation of the transducers with portable Variofix rail and chains

Normally, each transducer is mounted in its own Variofix rail. If the transducer distance is small and both transducers are on the same side of the pipe (reflection arrangement), both transducers can be fixed in one Variofix rail.

Installation of the Variofix rail

- Adjustment of the Variofix rail to transducer width:
 - Loosen the 4 screws (1) for the adjustment of the rails (2) with an M8 wrench, see Fig. 6.11.
 - Place one transducer (3) in the center of the rails.
 - Press the two rails (2) together and tighten the 4 screws (1). The transducer can be shifted and removed.
 - Remove the transducer.
- Loosen the chain tensioner (4), but do not unscrew it completely.
- If the chain has not been mounted in the rail support (6) yet:
Compress the spring of the chain tensioner (4) with the cylinder (7) while pushing the chain tensioner (4) in the horizontal groove (5) of the rail support (6).
- Place the Variofix rail on the pipe. Both rail supports (6) have to be completely supported by the pipe.
- Lay the ball chain (8) around the pipe (if the pipe is vertical, start with the upper ball chain).
- Press the chain tensioner (4) inside completely and push the ball chain (8) into the other groove (9) of the rail support.
- Fix the second ball chain (8) in the same way.
- Tension the ball chains (8) by tightening the chain tensioners (4).
- Repeat the steps if the second transducer is fixed to its own Variofix rail.

Installation of the transducer

- Force the legs of the spring clip (10) apart and clamp it over the outer side of the rails (2). The height where the spring clip will snap in depends on the height of the transducer.
- Apply some coupling compound to the contact surface of the transducer.
- Place the transducer between the rails (2).
- Observe the mounting direction, see Fig. 6.11.
- Push the spring clip (10) over the transducer until the knurled screw (11) is positioned over the blind hole of the transducer.
- Fix the transducer by tightening the knurled screw by hand (11).
- Repeat the steps for fixing the second transducer.
- Adjust the transducer distance by loosening the knurled screw (11) of a spring clip (10) and shifting the transducer.

Fig. 6.11: Variofix rail with chains

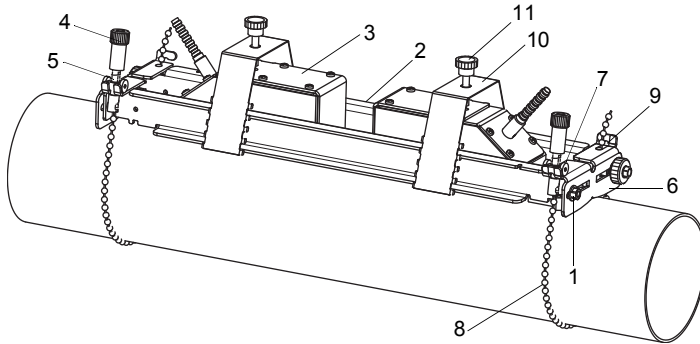

- 1 – screw
- 2 – rail
- 3 – transducer
- 4 – chain tensioner
- 5 – horizontal groove
- 6 – rail support
- 7 – cylinder
- 8 – ball chain
- 9 – groove
- 10 – spring clip
- 11 – knurled screw

6.3 Temperature probe

6.3.1 Pipe preparation

Caution!



Contact with grinding dust

This may result in injuries (e.g., breathing difficulties, skin reactions, eye irritations).

- Wear the required personal protective equipment.
- Observe the applicable rules.

Important!

The pipe has to be sufficiently stable to withstand the pressure exerted by the temperature probe.

Rust, paint or deposits on the pipe isolate the temperature at the measuring point. A good thermal contact between the pipe and the temperature probe is obtained as follows:

- Clean the pipe at the selected measuring point.
 - Remove any insulation material, rust or loose paint.
 - If present, the paint layer has to be smoothed by grinding. The paint does not need to be removed completely.
- Use coupling foil or apply a layer of thermal conductivity paste or coupling compound on the contact surface of the temperature probe.
- Observe the corresponding operating temperature range.
- Observe that there must be no air pockets between the contact surface of the temperature probe and the pipe wall.

6.3.2 Installation of the temperature probe (response time 50 s)

Notice!

The temperature probe has to be thermally insulated.

6.3.2.1 Installation with clasp

Caution!



The edge of the tension strap is very sharp.

Risk of injury!

- Debur sharp edges.
- Wear the required personal protective equipment.
- Observe the applicable rules.

- Cut the tension strap to length (pipe circumference + at least 120 mm).
- Make sure that part (2) of the clasp is on top of part (1), see Fig. 6.12 a. The hooks of part (2) have to be on the outer side of the clasp.
- Pull approx. 20 mm of the tension strap through the slot of the clasp to fix the clasp to the tension strap, see Fig. 6.12 b.
- Bend the end of the tension strap.
- Position the temperature probe on the pipe, see Fig. 6.13.
- Place the tension strap around the temperature probe and the pipe.
- Insert the tension strap through the parts (2) and (1) of the clasp.
- Tighten the tension strap and engage it in the inner hook of the clasp.
- Tighten the screw of the clasp.

Fig. 6.12: Clasp



Fig. 6.13: Temperature probe on the pipe

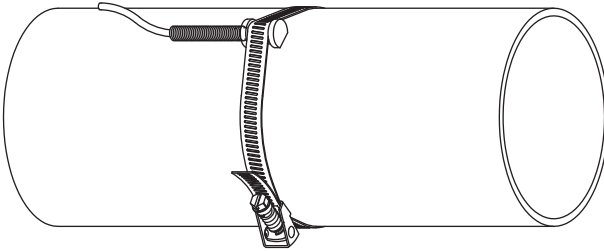

6.3.2.2 Installation with FLEXIM clasp

Caution!



The edge of the tension strap is very sharp.

Risk of injury!

- Debur sharp edges.
- Wear the required personal protective equipment.
- Observe the applicable rules.

- Cut the tension strap to length (pipe circumference + at least 120 mm).
- Insert approx. 20 mm of the tension strap into the slot of the clasp, see Fig. 6.14.
- Bend the end of the tension strap.
- Position the temperature probe on the pipe, see Fig. 6.13.
- Place the tension strap around the temperature probe and the pipe.
- Insert the tension strap through the parts (2) and (1) of the clasp.
- Pull the tension strap firmly and engage it in the inner hooks of the clasp.
- Tighten the screw of the clasp.

Fig. 6.14: FLEXIM clasp

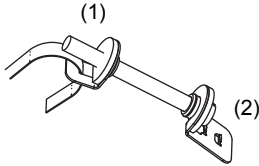

6.3.2.3 Installation with quick release clasp

Caution!



The edge of the tension strap is very sharp.

Risk of injury!

- Debur sharp edges.
- Wear the required personal protective equipment.
- Observe the applicable rules.

- Cut the tension strap to length (pipe circumference + at least 120 mm).
- Position the temperature probe on the pipe, see Fig. 6.13.
- Place the tension strap around the temperature probe and the pipe.
- Insert the tension strap into the clasp, see Fig. 6.15.
- Tighten the tension strap.
- Tighten the screw of the clasp.

Fig. 6.15: Quick release clasp



6.3.3 Installation of the temperature probe (response time 8 s)

- Fix the protection plate and the insulation foam to the temperature probe, see Fig. 6.16.
- Take the spring end of the chain and insert the first ball into one of the slots on the upper side of the temperature probe, see Fig. 6.17.
- Place the chain around the pipe. Tighten the chain and insert it into the other slot of the temperature probe.

Fig. 6.16: Temperature probe

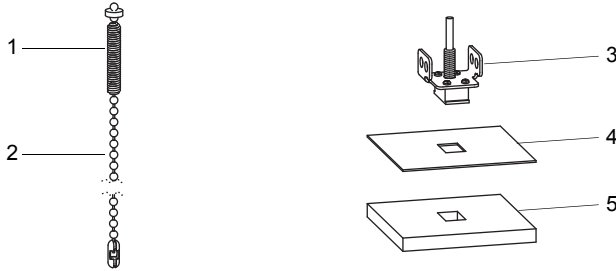

- 1 – spring end
- 2 – chain
- 3 – temperature probe
- 4 – protection plate
- 5 – insulation foam

Notice!

The entire contact surface of the temperature probe always has to rest on the pipe. In case of very small pipes, the protection plate and the insulation foam have to be cut to size, if necessary.

Fig. 6.17: Temperature probe on the pipe

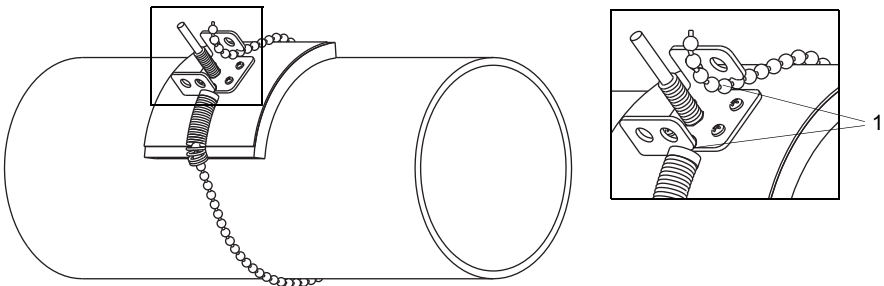

- 1 – slots on the upper side of the temperature probe

7 Connection

7.1 FLUXUS *601

7.1.1 Transducers

It is recommended to run the cables from the measuring point to the transmitter before connecting the transducers to avoid load on the connectors.

The connections are on the upper side of the transmitter, see Fig. 7.1.

- Pull up the socket cover, see Fig. 7.2.
- Insert the connector of the transducer cable into the socket of the transmitter. The red point (a) on the connector has to be aligned with the red marking (b) on the socket.

Fig. 7.1: Connections on the transmitter

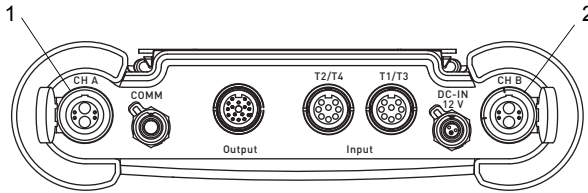

- 1 – transducers (measuring channel A)
- 2 – transducers (measuring channel B)

Fig. 7.2: Transducer connection

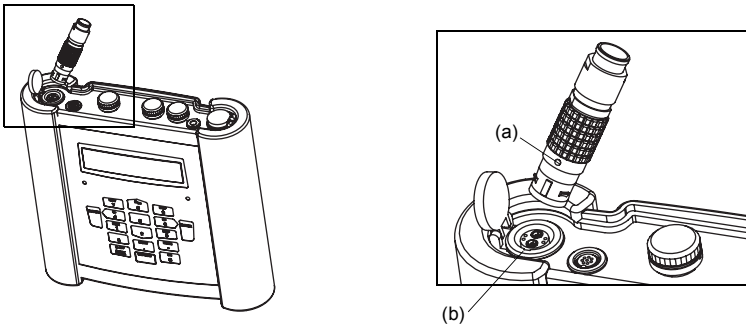

7.1.2 Power supply

The transmitter can be operated with the integrated battery, the power supply unit or the power pack PP026NN, see document QSPowerPack_PP026.

7.1.2.1 Battery operation

The transmitter has a Li-ion battery and can therefore be operated independently. When delivered, the battery is charged with approx. 30 %. The battery does not need to be fully charged before it is used for the first time.

Notice!

The specified battery life, see technical specification, can only be reached if unused current output are uninstalled.

The battery charge can be displayed during the measurement, see section 9.4.3 and in the program branch `Special Funct.:`

```
Special Funct.\Battery status
```

- Select the menu item `Special Funct.\Battery status`.
- Press ENTER.



The current battery charge is displayed (here: 30 %).

The minus sign (-) indicates that the transmitter is in battery mode and is being discharged.

The number of cycles the battery has passed is displayed after `Cy`. A cycle corresponds to a charging and discharging process. The life time of the battery can be derived by means of this value.

If `RELEARN` is displayed in the lower line and a question mark (?) is displayed after the current battery charge, a relearn cycle has to be started, see section "Maintenance" (relearn cycle) on the following page.

This message will be displayed if the battery is almost empty:

```
LOW BATTERY !
```

The capacity is sufficient for the display and storing of the current parameter record. A measurement is impossible.

Charging the battery

Connect the power supply to the transmitter, see section 7.1.2.2. Switch on the transmitter. The charging starts automatically. The LED "BATTERY" flashes green while charging. The max. charging time is approx. 8 h.

During the charging process, the ambient temperature should be in the range of 0...45 °C.

A measurement can be made during the charging. Charging will be stopped automatically when the battery is fully charged. The LED "BATTERY" lights green then.

Notice!

The battery will only be charged if the transmitter is switched on.

Battery storage

The battery remains in the transmitter. After storage, the transmitter can immediately be operated with the battery.

- battery charge: > 30 %
- storing temperature: 12...25 °C

Maintenance (relearn cycle)

The accuracy of the displayed value for the charge state of the battery is improved by executing a relearn cycle. The ambient temperature during a relearn cycle should be in the range of 12...30 °C.

Special Funct.\Battery status

- Select the menu item Special Funct.\Battery status.
- Press ENTER.

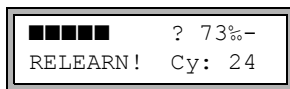

The charge state of the battery is displayed (here: 73 %).

The "?" and RELEARN indicate that the displayed charge state is not reliable. A relearn cycle is recommended.

- Charge the battery completely. The LED "BATTERY" lights green when charging is finished.
- Remove the power supply unit from the transmitter. Discharge the battery completely. In order to deactivate the automatic power-off during discharging, start a measurement. Discharging takes min. 14 h. The LED "BATTERY" will flash red afterwards.

Automatic power-off

In battery mode, the transmitter has an automatic power-off. The transmitter will be switched off if

- no measurement is being made and no key is pressed within 10 min or
- the battery is empty.

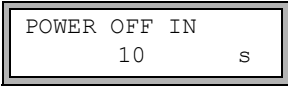

This message will be displayed before the transmitter is switched off automatically. A countdown with an acoustic signal will be started. The countdown can be stopped by pressing any key.

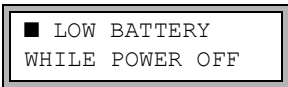

If this message is displayed when the transmitter is switched on, the transmitter has been switched off automatically due to a too low battery charge.

7.1.2.2 Power supply operation

Important!

- Use only the supplied power supply unit.
- The power supply is not protected against moisture. Use it only in dry rooms.
- The voltage indicated on the power supply unit must not be exceeded.
- Do not connect a defective power supply unit to the transmitter.

- Connect the power supply unit to the socket on the upper side of the transmitter, see Fig. 7.3.

Fig. 7.3: Connection of the power supply unit to the transmitter

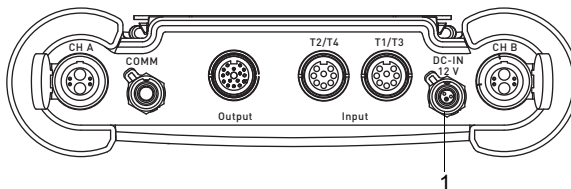

1 – power supply unit/battery charging unit

7.1.3 Outputs

Warning!



Danger in presence of conductive pollution

Open the box of the adapter in safe ambient conditions only (e.g., air humidity < 90 %, no conductive pollution, no explosive atmosphere).

Notice!

For the connection, observe the specifications regarding the assignment of the outputs given on the nameplate on the rear side of the transmitter.

Important!

The max. voltage between the outputs and the internal power supply of the transmitter is 42 V DC (permanent).

Connection of an output adapter

All available outputs are connected via the output adapter, see Fig. 7.4. For the connection of the outputs, see Fig. 7.4 and Tab. 7.1. If several outputs are required, the Modbus adapter or the output adapter can be used for 2 current outputs.

Fig. 7.4: Connection of the output adapter to the transmitter

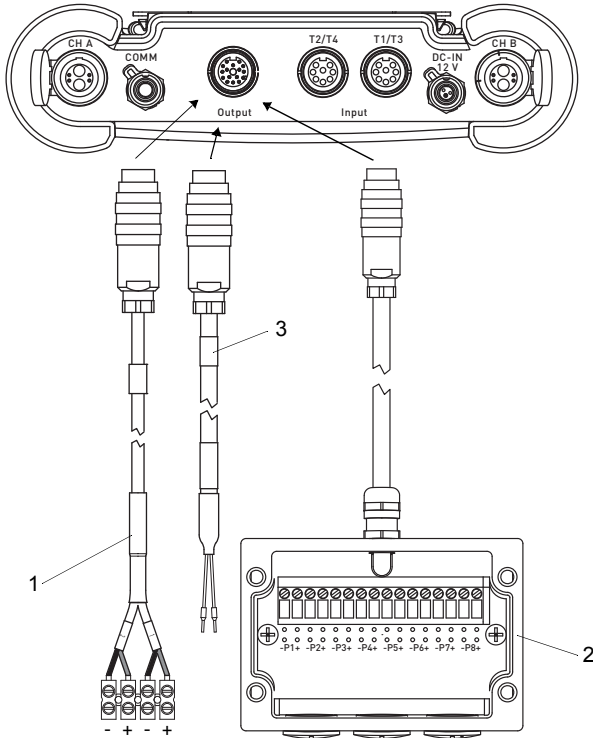

- 1 – output adapter for 2 current outputs (red (+), black (-))
- 2 – output adapter
- 3 – Modbus adapter

Tab. 7.1: Circuit of the outputs

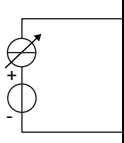
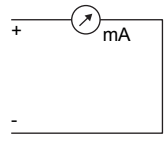
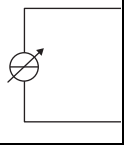
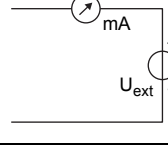
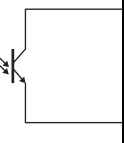
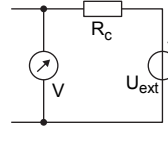
output	transmitter		external circuit	remark
	internal circuit	connection		
switchable current output (1)	active current output			
		Px+ Px-		$R_{ext} < 350 \Omega$ $U_{max} = 28 V$ ($R_{ext} \rightarrow \infty$) $U_{int} = 24 V \pm 2.4 V$
	passive current output			
		Px+ Px-		$U_{ext} = 8 \dots 30 V$ $U_{ext} > 0.024 A \cdot R_{ext} [\Omega] + 8 V$ example: $U_{ext} = 12 V$ $R_{ext} \leq 160 \Omega$
frequency output (open collector)		Px+ Px-		$U_{ext} = 5 \dots 24 V$ $R_c [k\Omega] = U_{ext} / I_c [mA]$ $I_c = 1 \dots 4 mA$

The number, type and the connections of the outputs depend on the order.

R_{ext} is the sum of all ohmic resistances in the circuit (e.g., resistance of the conductors, resistance of the ammeter/voltmeter).

(1) All switchable current outputs are jointly switched to active and passive in the menu item Special Version\SYSTEM settings\Proc. outputs.

Tab. 7.1: Circuit of the outputs

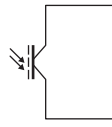
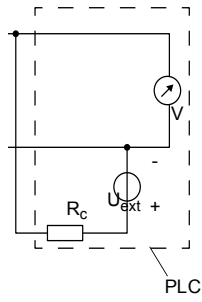
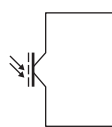
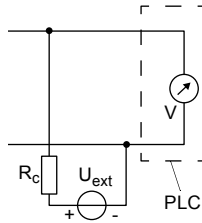
output	transmitter		external circuit	remark
	internal circuit	connection		
binary output (optorelay)	circuit 1			$U_{ext} \leq 26 \text{ V}$ $I_c \leq 100 \text{ mA}$ $R_c [\text{k}\Omega] = U_{ext} / I_c [\text{mA}]$
		Px+ Px-		
	circuit 2			
		Px+ Px-		

The number, type and the connections of the outputs depend on the order.

R_{ext} is the sum of all ohmic resistances in the circuit (e.g., resistance of the conductors, resistance of the ammeter/voltmeter).

⁽¹⁾ All switchable current outputs are jointly switched to active and passive in the menu item Special Version\SYSTEM settings\Proc. outputs.

7.1.4 Inputs

Notice!

For the connection, observe the specifications regarding the assignment of the inputs given on the nameplate on the rear side of the transmitter.

Important!

The max. voltage between the inputs and the internal power supply of the transmitter is 42 V DC (permanent).

7.1.4.1 Input adapter

The transmitter is equipped with max. 4 inputs (T1...T4). The type and number of inputs are stated on the nameplate.

It is possible to connect temperature probes, voltage and current sources to the inputs T1...T4. The inputs T1, T3 and T2, T4 are connected to their corresponding socket (T1/T3 and T2/T4), see Fig. 7.5.

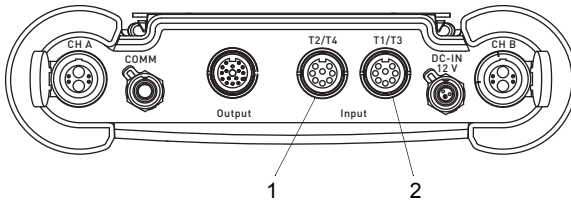
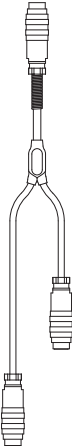

Fig. 7.5: Inputs of the transmitter



- 1 – socket T2/T4
- 2 – socket T1/T3

For the connection, adapters may be required.

Tab. 7.2: Adapter overview

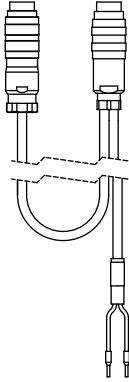
input adapter	adapter for voltage and current inputs	adapter for the active current input
		 <p style="text-align: center;">passive current sink</p>
<ul style="list-style-type: none"> • when using T1 and T3 • when using T2 and T4 • when using T3 • when using T4 	<ul style="list-style-type: none"> • for a current input • for a voltage input 	<ul style="list-style-type: none"> • for power supply via an active current output

7.1.4.2 Temperature input

It is possible to connect temperature probes Pt100/Pt1000 (4-wire) to the inputs of the transmitter (option), see Fig. 7.5.

For the assignment and the activation of the temperature inputs, see chapter 14.

If the transmitter has only 1 or 2 temperature inputs, the temperature probes are connected directly to the socket T1/T3 or T2/T4, see Fig. 7.6.

If the transmitter has 3 or 4 temperature inputs, the temperature probes are connected to the socket T1/T3 or T2/T4 via an input adapter, see Fig. 7.7.

Notice!

It is not necessary to connect the input adapter if only the input T1 or T2 is used, see Fig. 7.6.

Fig. 7.6: Connection of 1 or 2 temperature probes

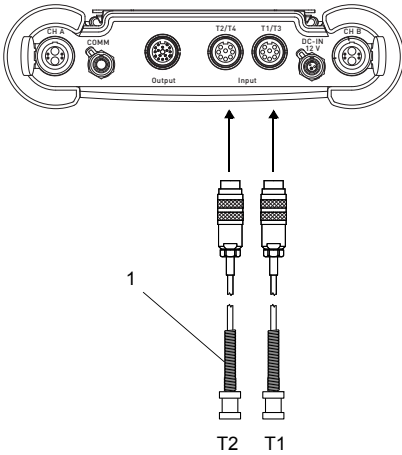

1 – temperature probe

Fig. 7.7: Connection of 3 or 4 temperature probes

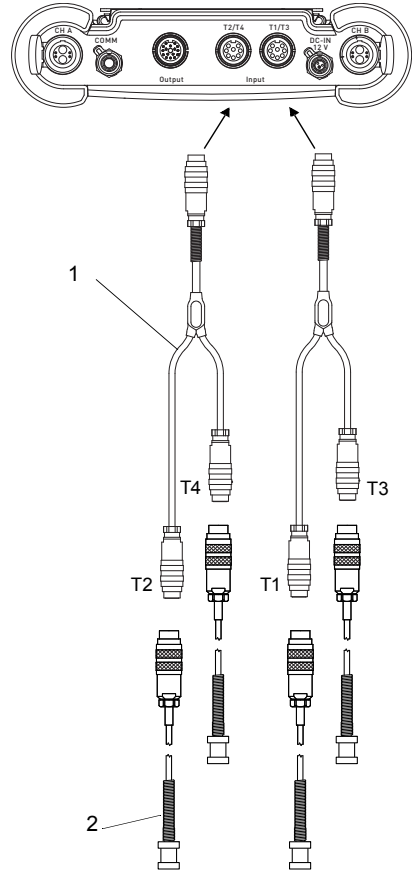

1 – input adapter
2 – temperature probe

The temperature probes are connected to the input adapter according to the information given on the nameplate.

7.1.4.3 Current input

It is possible to connect an active current source or a passive current sink with an external power supply to a passive current input.

Tab. 7.3: Connection of an active current source

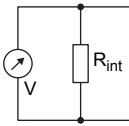
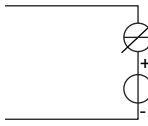
input	transmitter		external circuit	remark
	internal circuit	connection		
passive current input		+ -		permanent over-current max. 40 mA

Tab. 7.4: Connection of a passive current sink

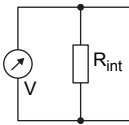
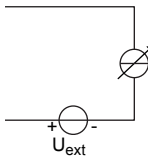
input	transmitter		external circuit	remark
	internal circuit	connection		
passive current input		+ -		permanent over-current max. 40 mA

An external voltage source U_{ext} is necessary. It has to provide a current of min. 20 mA and

- supply sufficient power for the requirements of the passive current sink and
- cover the voltage drop at the input resistor (1 V at 20 mA) and
- cover all other voltage drops (e.g., cable resistance) in the circuit.

If the transmitter has an active output, the output can be used as power supply by means of an adapter, see section 7.1.4.4.

Example

A passive current sink with an external power supply (e.g., a pressure transmitter) is to be connected to a passive current input.

Technical data of the pressure transmitter:

$$U_S = 11 \dots 30 \text{ V DC}$$

$$I_a = 4 \dots 20 \text{ mA } (I_{a \text{ max}} = 22 \text{ mA})$$

U_{ext} required for the operation of the passive pressure transmitter is:

$$U_{\text{ext min}} = U_{S \text{ min}} + I_{a \text{ max}} \cdot R_i + I_{a \text{ max}} \cdot R_c$$

$$U_{\text{ext min}} = 11 \text{ V} + 22 \text{ mA} \cdot 50 \Omega + 22 \text{ mA} \cdot 2 \Omega$$

$$U_{\text{ext min}} = 12.14 \text{ V}$$

$$U_{\text{ext max}} = U_{S \text{ max}}$$

$$U_{\text{ext max}} = 30 \text{ V}$$

U_S – operating voltage of the pressure sensor

I_a – output current

R_i – input resistance

R_c – cable resistance

If the transmitter has 1 or 2 voltage or current inputs, the voltage and current sources are connected to the socket T1/T3 or T2/T4 via an adapter, see Fig. 7.8.

If the transmitter has 3 or 4 inputs, the adapters for the voltage and current inputs are connected to the sockets T1/T3 and T2/T4 via input adapters, see Fig. 7.7.

Notice!

It is not necessary to connect the input adapter if only the inputs T1 or T2 are used, see Fig. 7.8.

Fig. 7.8: Connection of 1 or 2 voltage and current sources

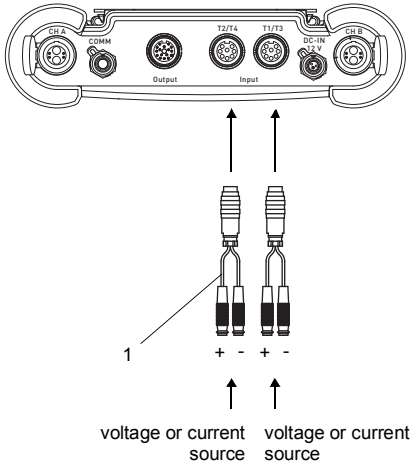

1 – adapter for voltage and current inputs

Fig. 7.9: Combination of temperature, voltage and current measurement (example)

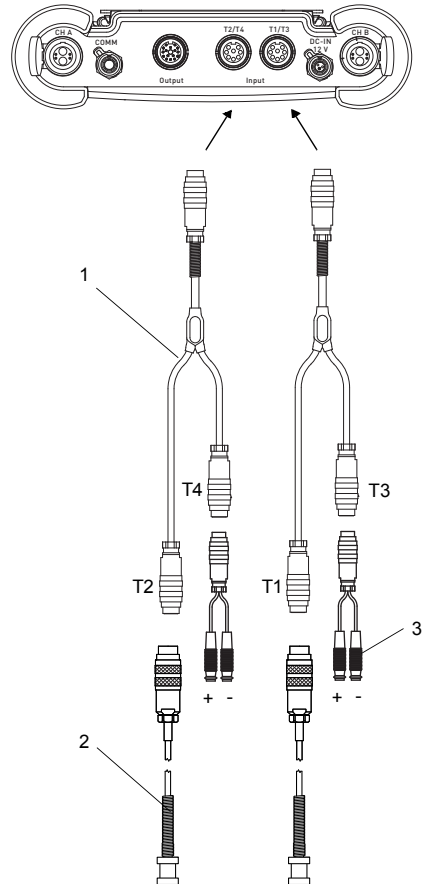

1 – input adapter

2 – temperature probe

3 – adapter for voltage and current inputs

The temperature probes, voltage or current sources are connected to the input adapter according to the information given on the nameplate.

7.1.4.4 Connection of a passive current sink to a passive current input

For the connection of a passive current sink (e.g., pressure transmitter) to a passive current input, an external power supply has to be provided.

If the transmitter has an active current output, the output can be used as power supply by means of the adapter for the active current input. The adapter is connected to the T1/T3 or T2/T4 socket and to the output socket, see Fig. 7.10 and Tab. 7.1. The adapter connects the active current output with the passive current input and the passive current sink with the transmitter.

If 2 passive current sinks are to be fed via the transmitter, the active current outputs can be connected with the passive current inputs via the output adapter. In this case the adapter for the active current input cannot be used.

Fig. 7.10: Connection of the adapter for the active current input

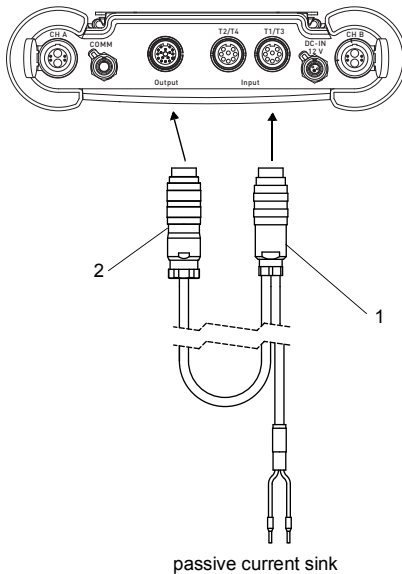

- 1 – connector for the connection to the current input
- 2 – connector for the connection to the current output

If the transmitter has 3 or 4 inputs, the adapter for the active current input is connected to the transmitter via an input adapter. The input adapter is connected whether to the T1/T3 or T2/T4 socket, see Fig. 7.11.

The temperature probes, voltage or current sources are connected to the adapters according to the information given on the nameplate.

Fig. 7.11: Combination of temperature, voltage and current measurement (example)

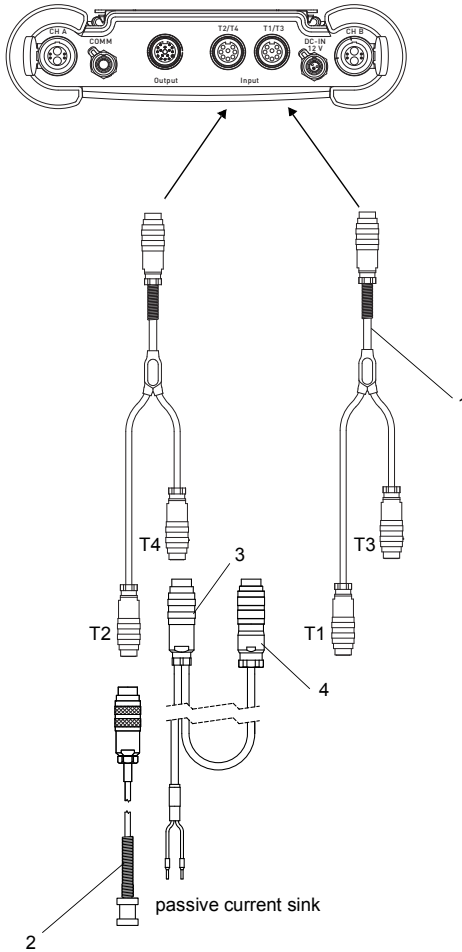

- 1 – input adapter
- 2 – temperature probe
- 3 – adapter for the active current input
- 4 – connector for the connection of an active current output

For the configuration of an output see section 13.1.

7.1.5 Serial interface

- Connect the RS232 cable to the transmitter, see Fig. 7.12, and to the serial interface of the PC.
- Use the RS232 adapter for the connection of the RS232 cable to the transmitter. If the RS232 cable cannot be connected to the PC, use the RS232/USB adapter.

The RS232 adapter, the RS232 cable and the RS232/USB adapter are part of the serial data kit (optional).

Notice!
If a problem occurs when using the RS232/USB adapter for connection, contact your system administrator.

Fig. 7.12: Connection of the serial interface

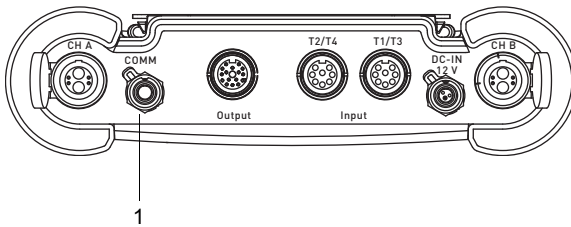

1 – serial interface

7.2 FLUXUS *608

Danger!



Risk of explosion when using the measuring instrument in explosive atmospheres (ATEX, IECEx)

This may result in personal or material damage or other dangerous situations.

→ Observe the "Safety instructions for the use in explosive atmospheres", see document SIFLUXUS_608.

Danger!



Risk of explosion when using the measuring instrument FLUXUS *608-F2 in explosive atmospheres**

This may result in personal or material damage or other dangerous situations.

→ Observe the "Safety instructions for the use in explosive atmospheres", see document SIFLUXUS_608F2.

7.2.1 Transducers

It is recommended to run the cables from the measuring point to the transmitter before connecting the transducers to avoid load on the connectors.

FLUXUS *608**-A2

The connections are on the upper side of the transmitter, see Fig. 7.13.

- Remove the blind plug, see Fig. 7.14.
- Insert the connector of the transducer cable into the socket of the transmitter. The red point (a) on the connector has to be aligned with the red marking (b) on the socket, see Fig. 7.15.

Fig. 7.13: Connection of the transducers to the transmitter

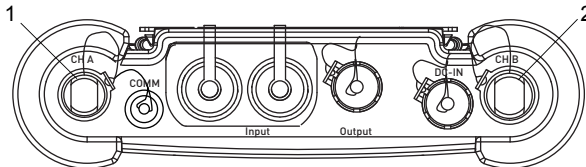

- 1 – transducers (measuring channel A)
- 2 – transducers (measuring channel B)

Fig. 7.14: Removal of the blind plug

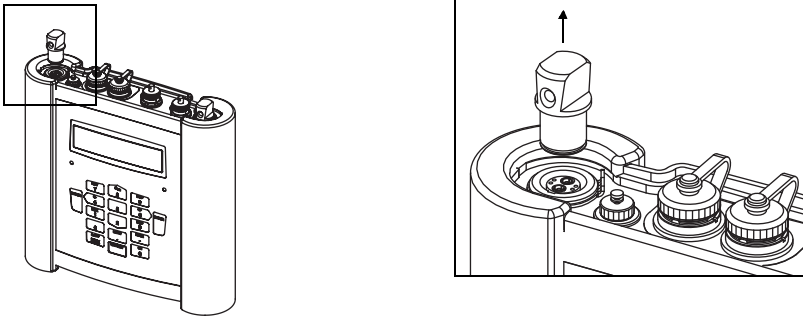
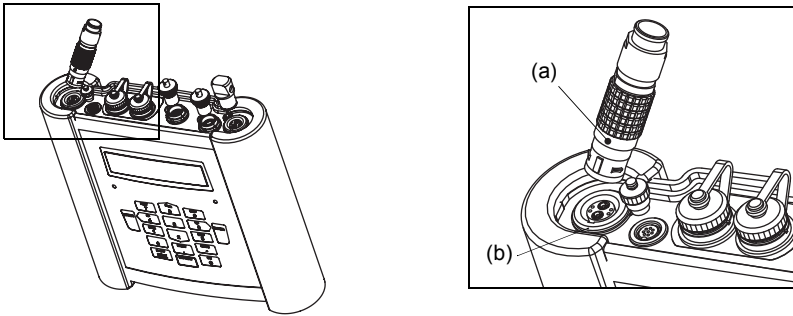

Fig. 7.15: Connection of the transducers



FLUXUS *608**-F2

The connections are on the upper side of the transmitter, see Fig. 7.16.

- Remove the blind plug, if present.
- Insert the connector of the transducer cable into the socket of the transmitter. The red point (a) on the connector has to be aligned with the red marking (b) on the socket, see Fig. 7.17.
- Secure the connector with of the locking ring by tightening the locking screw.
- If a socket for transducer connection is not used, close it with a blind plug. Secure the blind plug by tightening the locking screw.

Fig. 7.16: Connection of the transducers to the transmitter

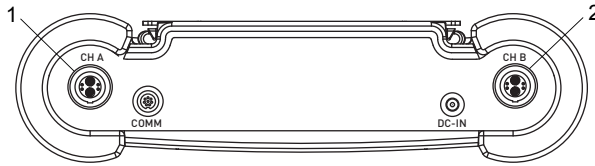

- 1 – transducers (measuring channel A)
- 2 – transducers (measuring channel B)

Fig. 7.17: Connection of the transducers

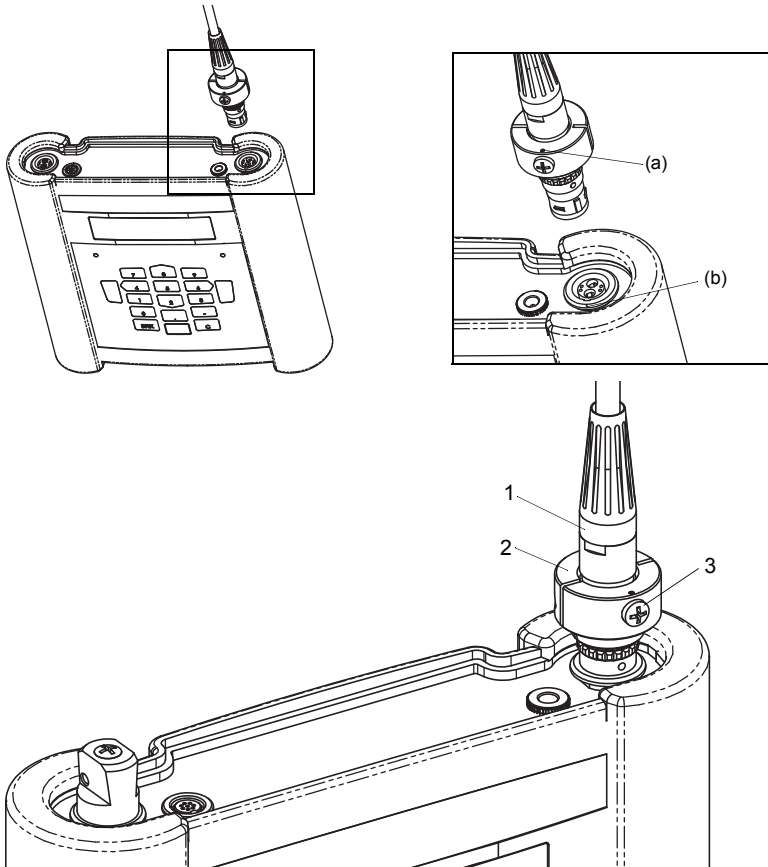

- 1 – transducer connector
- 2 – locking ring
- 3 – locking screw

7.2.2 Power supply

The transmitter can be operated with the integrated battery, the power cable with power adapter (FLUXUS *608**-A2) or the power supply unit (FLUXUS *608**-F2).

7.2.2.1 Battery operation

The transmitter has a Li-ion battery and can therefore be operated independently. When delivered, the battery is charged with approx. 30 %. The battery does not need to be fully charged before it is used for the first time.

The battery charge can be displayed during the measurement, see section 9.4.3 and in the program branch `Special Funct.:`

```
Special Funct.\Battery status
```

- Select the menu item `Special Funct.\Battery status`.
- Press ENTER.



The current battery charge is displayed (here: 30 %).

The minus sign (-) indicates that the transmitter is in battery mode and is being discharged.

The number of cycles the battery has passed is displayed after `Cy`. A cycle corresponds to a charging and discharging process. The life time of the battery can be derived by means of this value.

If `RELEARN` is displayed in the lower line and a question mark (?) is displayed after the current battery charge, a relearn cycle has to be started, see section "Maintenance" (re-learn cycle) on the following page.

This message will be displayed if the battery is almost empty:

```
LOW BATTERY !
```

The capacity is sufficient for the display and storing of the current parameter record. A measurement is impossible.

Charging the battery

Connect the power supply to the transmitter, see Fig. 7.18 (FLUXUS *608**-A2) or Fig. 7.19 (FLUXUS *608**-F2). Switch on the transmitter. The charging starts automatically. The LED "BATTERY" flashes green while charging. The max. charging time is approx. 8 h.

During the charging process, the ambient temperature should be in the range of 0...45 °C.

A measurement can be made during the charging. Charging will be stopped automatically when the battery is fully charged. The LED "BATTERY" lights green then.

Notice!

The battery will only be charged if the transmitter is switched on.

Fig. 7.18: Connection of the power supply unit to the transmitter FLUXUS *608**-A2

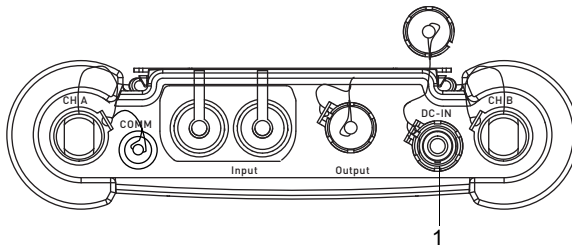

1 – power supply unit/battery charging unit

Fig. 7.19: Connection of the power supply unit to the transmitter FLUXUS *608**-F2

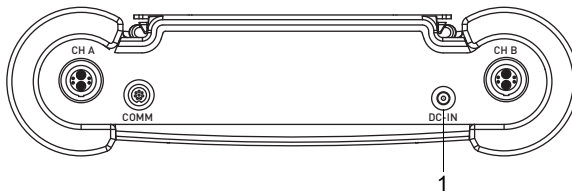

1 – power supply unit/battery charging unit

Battery storage

The battery remains in the transmitter. After storage, the transmitter can immediately be operated with the battery.

- battery charge: > 30 %
- storing temperature: 12...25 °C

Maintenance (relearn cycle)

The accuracy of the displayed value for the charge state of the battery is improved by executing a relearn cycle. The ambient temperature during a relearn cycle should be in the range of 12...30 °C.

Special Funct.\Battery status

- Select the menu item Special Funct.\Battery status.
- Press ENTER.

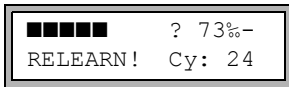

The charge state of the battery is displayed (here: 73 %).

The "?" and RELEARN indicate that the displayed charge state is not reliable. A relearn cycle is recommended.

- Charge the battery completely. The LED "BATTERY" lights green when charging is finished.
- Remove the power supply unit from the transmitter. Discharge the battery completely. In order to deactivate the automatic power-off during discharging, start a measurement. Discharging takes min. 14 h. The LED "BATTERY" will flash red afterwards.

Automatic power-off

In battery mode, the transmitter has an automatic power-off. The transmitter will be switched off if

- no measurement is being made and no key is pressed within 10 min or
- the battery is empty.

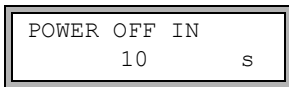

This message will be displayed before the transmitter is switched off automatically. A countdown with an acoustic signal will be started.

The countdown can be stopped by pressing any key.

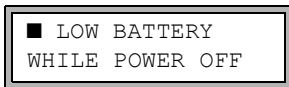

If this message is displayed when the transmitter is switched on, the transmitter has been switched off automatically due to a too low battery charge.

7.2.2.2 Power supply with adapter (option)

FLUXUS *608-A2**

If the transmitter is operated within an explosive atmosphere, the power supply has to take place via the power adapter and the connection adapter, see Fig. 7.20.

Fig. 7.20: Connection of external adapters

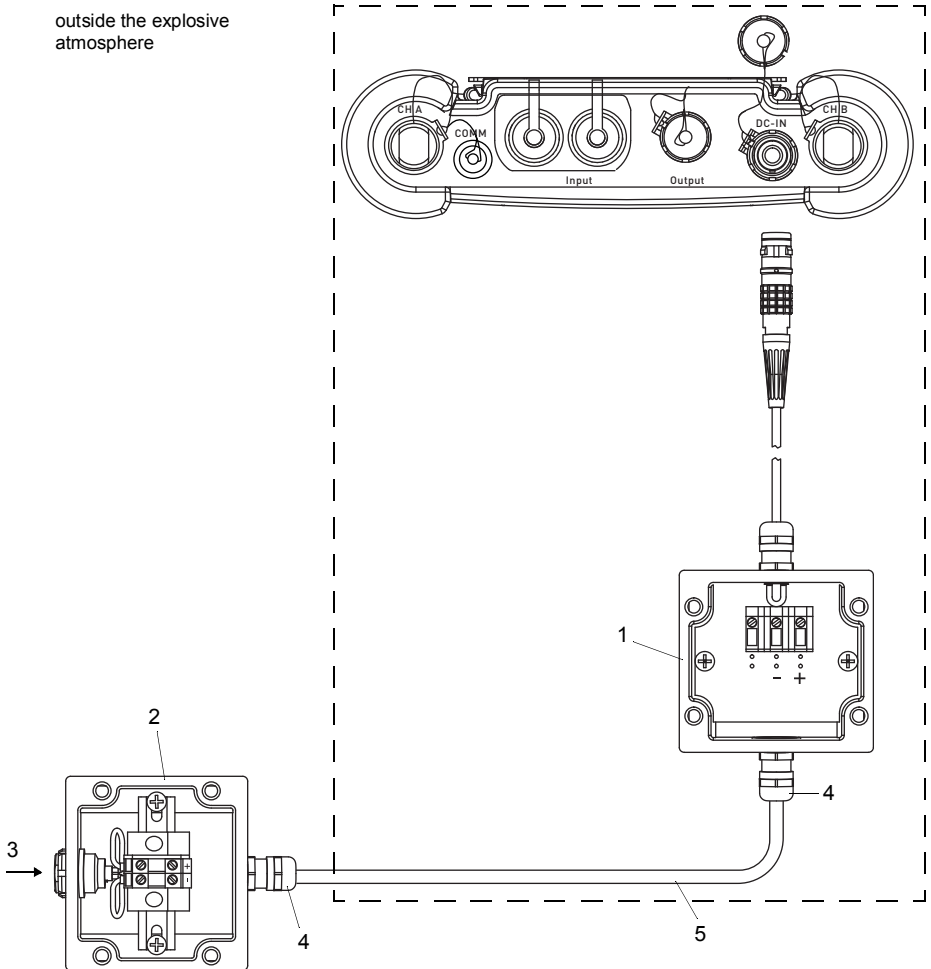

- 1 – power adapter
- 2 – connection adapter
- 3 – connection for power supply unit
- 4 – cable gland M20 (provided by customer)
- 5 – cable (provided by customer)

Fig. 7.21: Cable gland

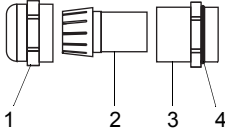

- 1 – cap nut
- 2 – compression part
- 3 – basic part
- 4 – gasket ring side of the basic part

- Remove the blind plug.
- Prepare the cable with a cable gland.
- Push the cable through the cap nut, the compression part and the basic part of the cable gland, see Fig. 7.21.
- The used cable has to have a wire cross-section of 1.5...2.5 mm².
- Push the cable through the cap nut, compression part and basic part of the cable gland.
- Insert the cable into the housing of the power adapter.
- Screw the sealing ring side of the basic part into the housing of the power adapter.
- Fix the cable gland by screwing the cap nut onto the basic part of the cable gland.
- Connect the cable to the terminals of the power adapter, see Fig. 7.20 and Tab. 7.5.
- Repeat the steps for the connection adapter..
- Connect the connector of the power adapter to the socket of the transmitter, see Fig. 7.20.

Tab. 7.5: Terminal assignment

terminal		connection DC
power adapter	connection adapter	
+	+	+DC
-	-	-DC

7.2.2.3 Power supply operation (FLUXUS *608**-F2)

Important!

- Use only the supplied power supply unit.
- The power supply unit must only be used outside explosive atmospheres.
- The power supply is not protected against moisture. Use it only in dry rooms.
- The voltage indicated on the power supply unit must not be exceeded.
- Do not connect a defective power supply unit to the transmitter.

- Connect the power supply unit to the socket on the upper side of the transmitter, see Fig. 7.22.

Fig. 7.22: Connections on the transmitter

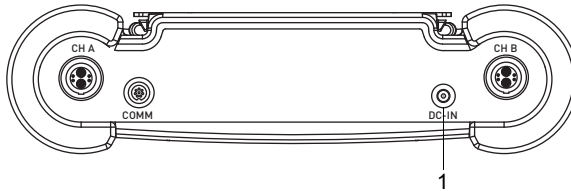

- 1 – power supply unit/battery charging unit

7.2.3 Outputs

The output adapter has to be used for the connection of the output adapters, see Fig. 7.23.

- Remove the blind plug.
- Prepare the output cable with an M20 cable gland.
- Push the output cable through the cap nut, the compression part and the basic part of the cable gland, see Fig. 7.24.
- Insert the output cable into the housing of the output adapter, see Fig. 7.23.
- Screw the sealing ring side of the basic part into the housing of the output adapter.
- Fix the cable gland by screwing the cap nut onto the basic part of the cable gland, see Fig. 7.24.
- Connect the leads of the output cable to the terminals of the output adapter, see Fig. 7.23 and Tab. 7.6.
- Remove the socket cover from the transmitter for the connection of the output adapter.
- Connect the connector of the output adapter to the socket.

Fig. 7.23: Connection of the output adapter to the transmitter

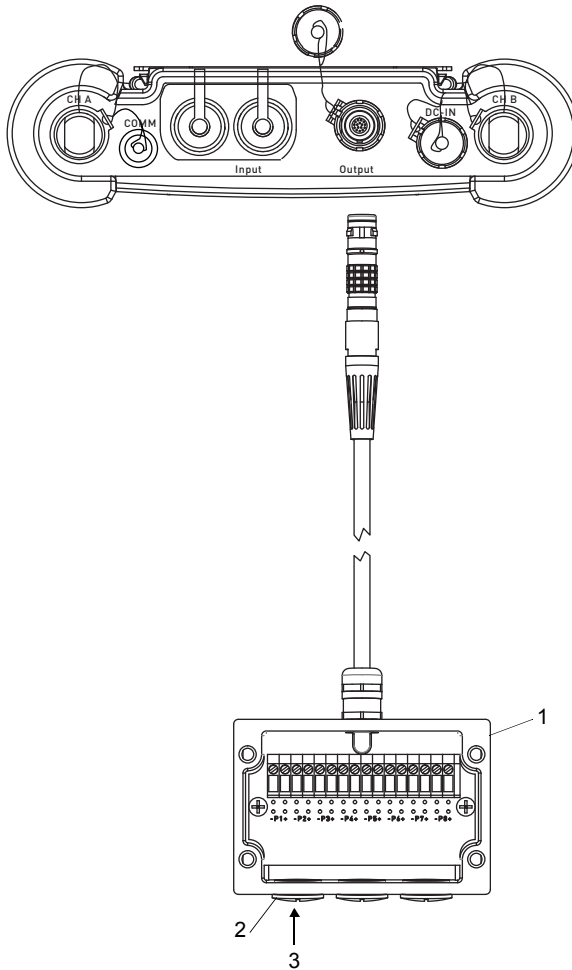

- 1 – output adapter
- 2 – blind plug
- 3 – connection of the outputs

Fig. 7.24: Cable gland

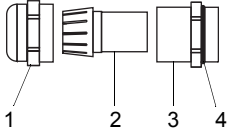

- 1 – cap nut
- 2 – compression part
- 3 – basic part
- 4 – gasket ring side of the basic part

Tab. 7.6: Circuit of the outputs

output	transmitter		external circuit	remark
	internal circuit	connection		
passive current output		Px+ Px-		$U_{ext} = 4 \dots 9 \text{ V}$ $U_{ext} > 0.021 \text{ A} \cdot R_{ext} [\Omega] + 4 \text{ V}$ example: $U_{ext} = 6 \text{ V}$ $R_{ext} \leq 90 \Omega$
frequency output (open collector)		Px+ Px-		$U_{ext} = 5 \dots 24 \text{ V}$ $R_c [\text{k}\Omega] = U_{ext} / I_c [\text{mA}]$ $I_c = 1 \dots 4 \text{ mA}$

The number, type and the connections of the outputs depend on the order.

R_{ext} is the sum of all ohmic resistances in the circuit (e.g., resistance of the conductors, resistance of the ammeter/voltmeter).

Tab. 7.6: Circuit of the outputs

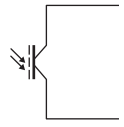
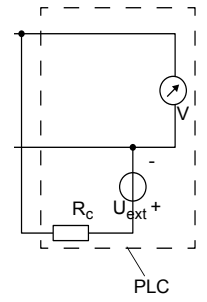
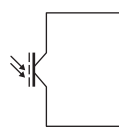
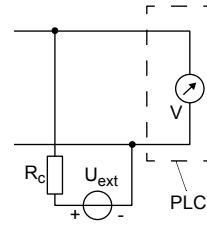
output	transmitter		external circuit	remark
	internal circuit	connec-tion		
binary output (optorelay)	circuit 1			$U_{ext} \leq 26 \text{ V}$ $I_c \leq 100 \text{ mA}$ $R_c [\text{k}\Omega] = U_{ext}/I_c [\text{mA}]$
		Px+ Px-		
	circuit 2			
		Px+ Px-		

The number, type and the connections of the outputs depend on the order.

R_{ext} is the sum of all ohmic resistances in the circuit (e.g., resistance of the conductors, resistance of the ammeter/voltmeter).

7.2.4 Inputs (optional)

Notice!

For the connection, observe the specifications regarding the assignment of the inputs given on the nameplate on the backside of the transmitter.

Notice!

The max. voltage between the inputs and the internal power supply of the transmitter is 42 V DC (permanent).

7.2.4.1 Temperature input

It is possible to connect temperature probes Pt100/Pt1000 (4-wire) to the inputs of the transmitter (optional).

For the assignment and the activation of the temperature inputs, see chapter 14.

Fig. 7.25: Connections on the transmitter FLUXUS *608** -A2

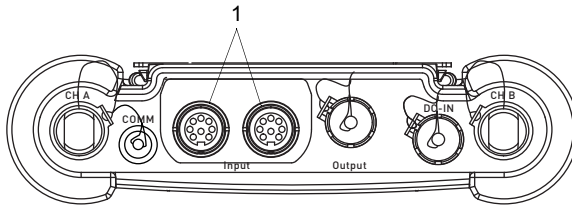

1 – inputs

Fig. 7.26: Connections on the transmitter FLUXUS *608** -F2

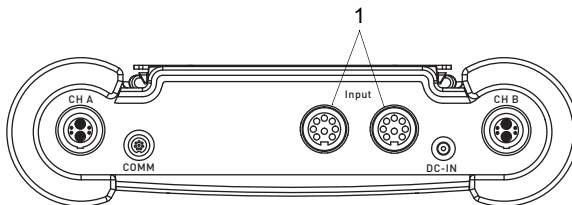

1 – inputs

7.2.4.2 Input adapter (optional)

The number of temperature inputs can be increased to max. 4 by means of 2 input adapters.

Fig. 7.27: Connection of the input adapter to the transmitter FLUXUS *608** -A2

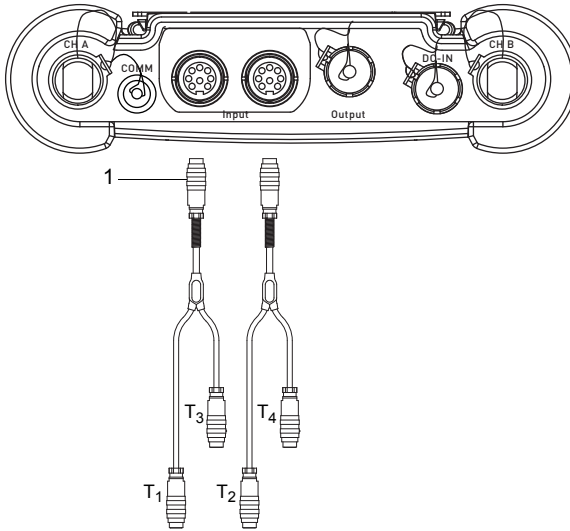

1 – input adapter

Fig. 7.28: Connection of the input adapter to the transmitter FLUXUS *608** -F2

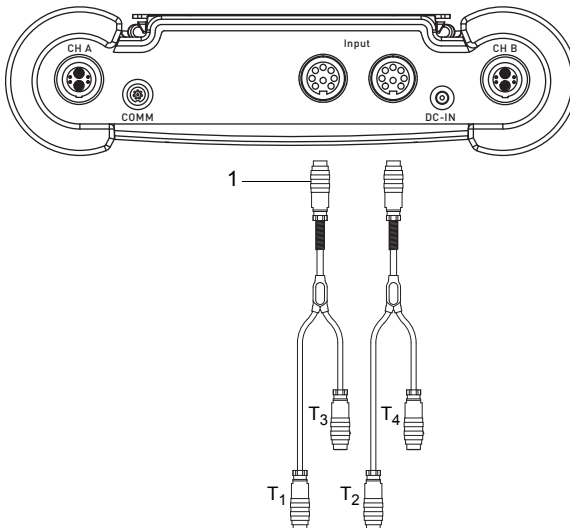

1 – input adapter

7.2.5 Serial interface

- Connect the RS232 cable to the transmitter and the serial interface of the PC.
- Use the RS232 adapter for the connection of the RS232 cable to the transmitter. If the RS232 cable cannot be connected to the PC, use the RS232/USB adapter.

The RS232 adapter, the RS232 cable and the RS232/USB adapter are part of the serial data kit (optional).

Notice!
If a problem occurs when using the RS232/USB adapter for connection, contact your system administrator.

Fig. 7.29: Connection of the serial interface to the transmitter FLUXUS *608**-A2

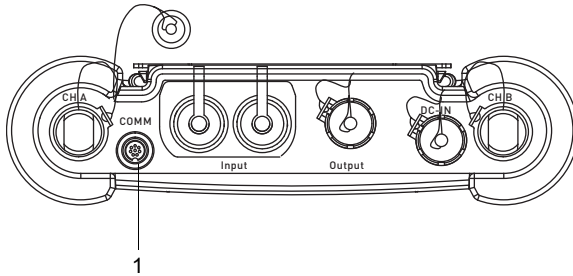

1 – serial interface

Fig. 7.30: Connection of the serial interface to the transmitter FLUXUS *608**-F2

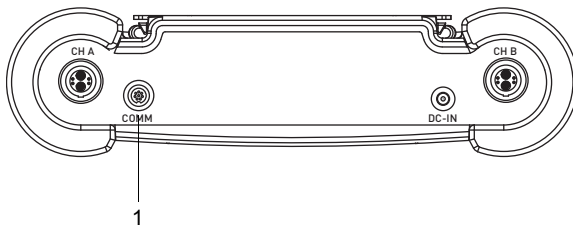

1 – serial interface

8 Start-up

Danger!



Risk of explosion when using the measuring instrument in explosive atmospheres (ATEX, IECEx)

This may result in personal or material damage or other dangerous situations.

→ Observe the "Safety instructions for the use in explosive atmospheres", see document SIFLUXUS_608.

Danger!



Risk of explosion when using the measuring instrument FLUXUS *608-F2 in explosive atmospheres**

This may result in personal or material damage or other dangerous situations.

→ Observe the "Safety instructions for the use in explosive atmospheres", see document SIFLUXUS_608F2.

8.1 Start-up settings

When starting up the transmitter for the first time, the following settings are required:

- language
- units of measurement
- date/time

These displays will only be indicated once when the transmitter is switched on for the first time.

Select language

The available transmitter languages are displayed.

- Select a language.
- Press ENTER.

The menus are displayed in the selected language.

Engineer. Units

- Select metric or imperial.
- Press ENTER.

CANADA-REGION

- Select `yes` if the transmitter is to be used in the region of Canada.
- Press ENTER.

This display will only be indicated if `imperial` is selected.

TIME

The current time is displayed.

- Press ENTER to confirm the time or to set the current time via the numeric field.
- Press ENTER.

DATE

The current date is displayed.

- Press ENTER to confirm the date or to set the current date via the numeric field.
- Press ENTER.

8.2 Switching on/off

Press key `C` to switch on the transmitter.

After switching on, it will be displayed which transducer has been detected at which measuring channel.

Afterwards, the serial number of the transmitter is displayed for a short time. It is not possible to enter any data while the serial number is displayed.

Afterwards, the main menu is displayed in the default language. The language of the display can be set, see section 8.4.

Press key `BRK` 3 times to switch off the transmitter.

8.3 Program branches

The following schema shows the program branches. For a detailed overview of the menu structure see annex A.

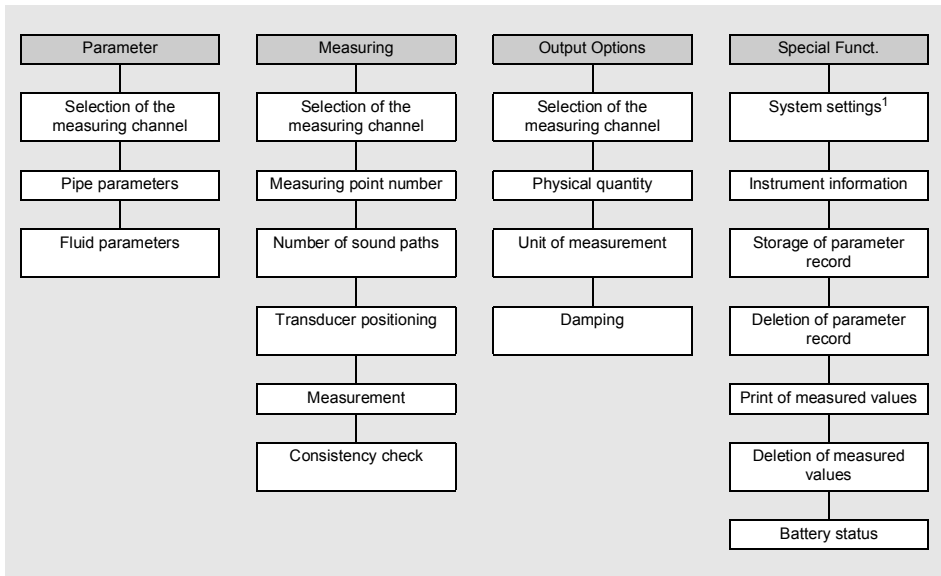

¹ SYSTEM settings contains the following menu items:

- dialogs and menus
- Inputs
- measurement
- outputs
- storing
- snap
- network
- serial transmission
- miscellaneous
- clock settings
- libraries

8.4 HotCodes

A HotCode is a digit sequence that activates certain functions or changes settings.

A HotCode can only be entered in the main menu immediately after switching on the transmitter. The HotCode is not displayed during the input.

function	HotCode	deactivation
reset of the display to medium contrast	555000	
language	9090xx	
enabling the FastFood mode	007022	HotCode 007022
settings of transducer temperature output and flow velocity storing	007043	
manual input of the lower limit for the inner pipe diameter	071001	
activation of the SuperUser mode	071049	switching off the transmitter
activation of the BTU mode	007025	HotCode 007025
transmission parameters change of the RS232 service interface	232-0-	

8.5 Language

The language can be selected with the following HotCodes:

language	HotCode
Dutch	909031
French	909033
Spanish	909034
English	909044
German	909049

When the last digit has been entered, the main menu is displayed in the selected language.

The selected language remains activated when the transmitter is switched off and on again. After an initialization of the transmitter, the language is reset to the default language.

8.6 Initialization

During an initialization (INIT) of the transmitter, the settings in the program branches `Parameter` and `Output Options` and some of the settings in the program branch `Special Funct.` are reset to the default settings of the manufacturer.

Proceed as follows to execute an initialization:

- When switching on the transmitter: keep keys BRK and C pressed.
- During the operation of the transmitter: press keys BRK, C and ENTER at the same time. A reset is executed. Release only key ENTER. Keep keys BRK and C pressed.

After the initialization has been executed, the message `INITIALISATION DONE` is displayed.

After the initialization, the remaining settings of the transmitter can be reset to the default settings and/or the stored measured values can be deleted.

FACTORY DEFAULT

- Select `yes` to reset the remaining settings of the transmitter to default settings or `no` to keep them at the current settings.
- Press ENTER.

If `yes` is selected, the message `FACTORY DEFAULT DONE` will be displayed.

Delete Meas.Val.

- Select `yes` to delete the stored measured values or `no` to keep them.
- Press ENTER.

This display will only be indicated if measured values are stored in the transmitter.

8.7 Time and date

The transmitter has a battery-powered clock. Measured values are automatically stored with date and time.

```
Special Funct.\SYSTEM settings\Set Clock\TIME
```

- Select **Set Clock**.
- Press **ENTER**.

The current time is displayed.

- Select **ok** to confirm the time or **new** to adjust it.
- Press **ENTER**.
- Select the character to be edited with key **<4>** and **[6]**. Edit the selected character with key **[8]** and **[2]**.
- Press **ENTER**.

The new time is displayed.

- Select **ok** to confirm the time or **new** to adjust it again.
- Press **ENTER**.

```
Special Funct.\SYSTEM settings\Set Clock\DATE
```

After the time has been set, the date is displayed.

- Select **ok** to confirm the date or **new** to adjust it.
- Press **ENTER**.
- Select the character to be edited with key **<4>** and **[6]**. Edit the selected character with key **[8]** and **[2]**.
- Press **ENTER**.

The new date is displayed.

- Select **ok** to confirm the date or **new** to adjust it again.
- Press **ENTER**.

8.8 Instrument information

```
Special Funct.\Instrum. Inform.
```

- Select the menu item `Instrum. Inform.` to get information about the transmitter.
- Press ENTER.

```
x60x      -XXXXXXXXX
```

The type and the serial number of the transmitter are displayed in the upper line.

```
Free:      18327
```

The max. available data logger will be displayed in the lower line (here: 18327 additional measured values can be stored).

- Press ENTER.

```
V x.xx    tt.mm.jj
```

The firmware version of the transmitter is displayed with the date in the lower line.

- Press ENTER.

9 Measurement

Danger!



Risk of explosion when using the measuring instrument in explosive atmospheres (ATEX, IECEx)

This may result in personal or material damage or other dangerous situations.

→ Observe the "Safety instructions for the use in explosive atmospheres", see document SIFLUXUS_608.

Danger!



Risk of explosion when using the measuring instrument FLUXUS *608-F2 in explosive atmospheres**

This may result in personal or material damage or other dangerous situations.

→ Observe the "Safety instructions for the use in explosive atmospheres", see document SIFLUXUS_608F2.

9.1 Parameter input

Notice!

The parameters will only be stored when the program branch `Parameter` has been edited in its entirety.

Notice!

During the parameter input, the transducers have to be connected to the transmitter.

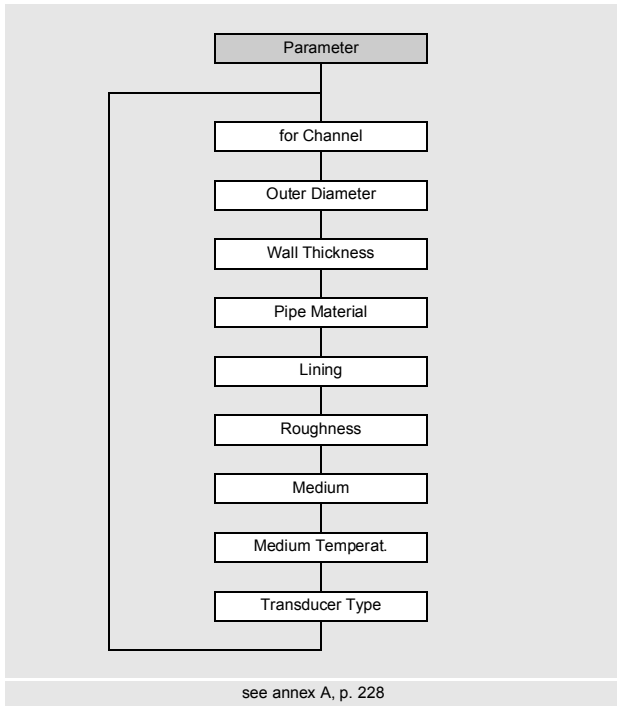

The pipe and fluid parameters are entered for the selected measuring point. The parameter ranges are limited by the technical characteristics of the transducers and the transmitter.

- Select the program branch `Parameter`.
- Press ENTER.

```
Parameter\for Channel A
```

- Select the channel for which the parameters are to be entered (here: Channel A).
- Press ENTER.

If `Parameter from` is displayed, at least on parameter record can be stored and can be selected. Each parameter record comprises all data necessary for a measurement:

- pipe parameters
- fluid parameter
- transducer parameter
- output options

A parameter record can be defined for each measuring task, see section 19.3.

9.1.1 Input of pipe parameters

Outer pipe diameter/pipe circumference

Parameter\Outer Diameter

- Enter the outer pipe diameter.
- Press ENTER.

An error message will be displayed if the entered parameter is outside the range. The limit is displayed.

Example: upper limit 1100 mm for the connected transducers and for a pipe wall thickness of 50 mm.

Outer Diameter
1100.0 MAXIMAL

It is possible to enter the pipe circumference instead of the outer pipe diameter, see section 19.1.

If the input of the pipe circumference is activated and zero is entered in `Outer Diameter`, the menu item `Pipe Circumfer.` will be displayed. If the pipe circumference is not to be entered, press key BRK to return to the main menu and start the parameter input again.

Notice!

The inner pipe diameter (= outer pipe diameter - 2 × pipe wall thickness) will be calculated internally.

If the value is not within the inner pipe diameter range of the connected transducers, an error message will be displayed.

It is possible to change the lower limit of the inner pipe diameter for a given transducer type, see section 17.11.

Pipe wall thickness

Parameter\Wall Thickness

- Enter the pipe wall thickness.
- Press ENTER.

Pipe material

```
Parameter\Pipe Material
```

The pipe material has to be selected to be able to determine the corresponding sound speed.

The sound speeds for the materials in the scroll list are stored in the transmitter.

- Select the pipe material.
- Press ENTER.
- If the material is not in the scroll list, select `Other Material`.
- Press ENTER.

Sound speed of the pipe material

```
Parameter\Pipe Material\Other Material\c-Material
```

- Enter the sound speed of the pipe material.
- Press ENTER.

Notice!

There are 2 sound speeds for pipe materials, the longitudinal and the transversal one. Enter the sound speed which is nearer to 2500 m/s.

These displays will only be indicated if `Other Material` is selected.

For the sound speed of some materials, see annex C.

Lining

```
Parameter\Lining
```

- Select `yes` if the pipe has a lining. Select `no` if the pipe has no lining.
- Press ENTER.

Lining material

```
Parameter\Lining
```

- Select the lining material.
- Press ENTER.
- If the lining material is not included in the scroll list, select `Other Material`.
- Press ENTER.

This display will only be indicated if `yes` is selected in the menu item `Lining`.

Sound speed of the lining material

Parameter\Lining\Other Material\c-Material

- Enter the sound speed of the lining material.
- Press ENTER.

Notice!

For pipe materials there are 2 sound speeds, the longitudinal and the transversal one. Enter the sound speed which is nearer to 2500 m/s.

These displays will only be indicated if `Other Material` is selected.

Lining thickness

Parameter\Liner Thickness

- Enter the thickness of the lining.
- Press ENTER.

This display will only be indicated if `yes` is selected in the menu item `Lining`.

Pipe roughness

Parameter\Roughness

The flow profile of the fluid is influenced by the roughness of the inner pipe wall.

The roughness is used for the calculation of the profile correction factor.

In most cases, the pipe roughness cannot be exactly determined and must therefore be estimated.

For the roughness of some materials, see annex C.

- Enter the roughness for the selected pipe or lining material.
- Change the value according to the condition of the inner pipe wall.
- Press ENTER.

Input of the disturbance distance

Parameter\Disturb.distance

- Enter the disturbance distance.
- Press ENTER.

This display will only be indicated if `With disturbance` is selected in the menu item `Special Funct.\SYSTEM settings\Measuring\ProfileCorr 2.0`.

9.1.2 Input of fluid parameters

Fluid

```
Parameter\Medium
```

- Select the fluid from the scroll list.
- Press ENTER.

If the fluid is not in the scroll list, select `Other Medium`.

If a fluid is selected from the scroll list, the menu item for the input of the fluid temperature will directly be displayed.

If `Other Medium` is selected, the following fluid parameters have to be entered first:

- average sound speed of the fluid
- range around the average sound speed of the fluid
- kinematic viscosity
- density

Sound speed of the fluid

```
Parameter\Medium\Other Medium\c-Medium
```

The sound speed of the fluid is used for the calculation of the transducer distance. The exact value of the sound speed is not always known. Therefore, a range of possible values for the sound speed has to be entered.

- Enter the average sound speed of the fluid.
- Press ENTER.

This display will only be indicated if `Other Medium` is selected.

Sound speed range of the fluid

```
Parameter\Medium\Other Medium\c-Medium range
```

- Select `auto` if the area around the average sound speed is to be calculated by the transmitter.
- Select `user` if the range around the average sound speed has to be entered.
- Press ENTER.

This display will only be indicated if `Other Medium` is selected.

```
Parameter\Medium\Other Medium\c-Medium range\c-Medium
```

- Enter the range around the average sound speed of the fluid.
- Press ENTER.

This display will only be indicated if `user` is selected.

Kinematic viscosity of the fluid

```
Parameter\Medium\Other Medium\Kinem.Viscosity
```

The kinematic viscosity influences the flow profile of the fluid. The value is considered in the profile correction.

- Enter the kinematic viscosity of the fluid.
- Press ENTER.

This display will only be indicated if `Other Medium` is selected.

Fluid density

```
Parameter\Medium\Other Medium\Density
```

The density is used to calculate the mass flow.

If the mass flow is not measured, an input is unnecessary. The default value can be used.

- Enter the operating density of the fluid.
- Press ENTER.

This display will only be indicated if `Other Medium` is selected.

Fluid temperature

```
Parameter\Medium Temperat.
```

At the beginning of the measurement, the fluid temperature is used for the interpolation of the sound speed and therefore for the calculation of the recommended transducer distance.

During the measurement, the fluid temperature is used for the interpolation of the density and viscosity of the fluid.

The value entered here is used for the calculation if the fluid temperature is not measured.

- Enter the fluid temperature. The value has to be within the operating temperature of the transducers.
- Press ENTER.

Fluid pressure

Parameter\Fluid pressure

The fluid pressure is used for the interpolation of the sound speed.

- Enter the fluid pressure.
- Press ENTER.

This display will only be indicated if the menu item `Special Funct.\SYSTEM settings\Dialogs/Menus\Fluid pressure` is activated.

9.1.3 Other parameters

Transducer parameter

If transducers are identified at a measuring channel, the input of parameters is finished. Press ENTER. The main menu will be displayed.

If no or special transducers are connected, the transducer parameters have to be entered.

Parameter\Transducer Type

- Select `Standard` to use the standard transducer parameters stored in the transmitter.
- Select `Special Version` to enter the transducer parameters. The transducer parameters have to be provided by FLEXIM.
- Press ENTER.

Notice!

If a standard transducer is selected, no transducer-specific calibration values are considered. A higher uncertainty has to be expected.

Parameter\Transducer Type\Special Version

If `Special Version` is selected, enter the 6 transducer parameters specified by FLEXIM. Press ENTER after each input.

9.2 Measurement settings

9.2.1 Selection of the physical quantity and the unit of measurement

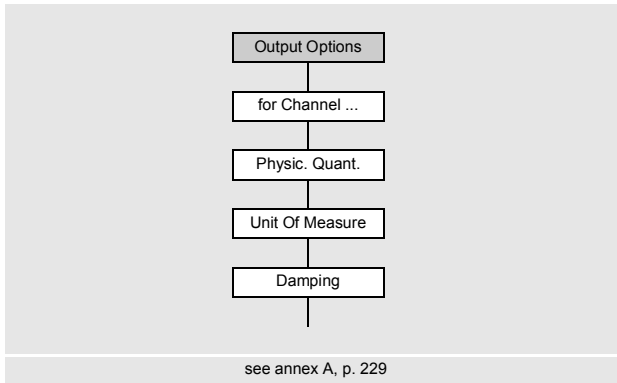

The following physical quantities can be measured:

- sound speed
- flow velocity: is calculated on the basis of the measured transit time difference
- volumetric flow rate: is calculated by multiplying the flow velocity by the cross-sectional pipe area
- mass flow rate: is calculated by multiplying the volumetric flow rate by the operating density of the fluid
- thermal energy rate (option): is calculated from the volumetric flow rate, the measured temperatures of the supply and return lines, and the thermal energy rate coefficients of the fluid

The physical quantity is selected as follows:

- Select the program branch `Output Options`.
- Press ENTER.

```
Output Options\for Channel A
```

- Select the channel for which a physical quantity has to be entered (here: `Channel A`).
- Press ENTER.

```
Output Options\for Channel A\Physic. Quant.
```

- Select the physical quantity in the scroll list.
- Press ENTER.

```
Output Options\for Channel A\Physic. Quant.\Volume flow
```

For the selected physical quantity (except for the sound speed), a scroll list with the available units of measurement is displayed. The unit of measurement which was selected previously is displayed first.

- Select the unit of measurement of the selected physical quantity.
- Press ENTER.

Notice!

If the physical quantity or the unit of measurement is changed, the settings of the outputs have to be checked, see section 9.2.3.

9.2.2 Input of the damping factor

Each displayed measured value is a floating average of all measured values of the last x seconds, with x being the damping factor. A damping factor of 1 s means that the measured values are not averaged because the measuring rate is approx 1/s. The default value of 10 s is appropriate for normal flow conditions. Values which fluctuate strongly due to a higher flow dynamic, require a higher damping factor.

```
Output Options\...\Damping
```

- Select the program branch `Output Options`.
- Press ENTER until the menu item `Damping` is displayed.
- Enter the damping factor.
- Press ENTER.
- Press key BRK to return to the main menu.

9.2.3 Installation of an output

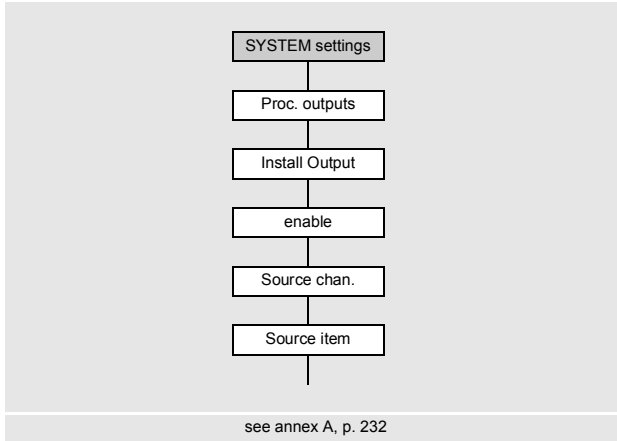

If the transmitter is equipped with outputs, they have to be installed and activated before they can be used:

- assignment of a measuring channel (source channel) to the output (if the transmitter has more than one measuring channel)
- assignment of the physical quantity (source item) to be transmitted to the output by the source channel, and the properties of the signal
- definition of the output behavior in case no valid measured values are available
- activation of the installed output in the program branch `Output Options`

In the following, the configuration of an analog outputs is described.

Notice!

The settings will be stored at the end of the dialog. If the menu item is quit by pressing key BRK, the changes will not be stored.

`Special Funct.\SYSTEM settings\Proc. outputs`

- Select the menu item `Special Funct.\SYSTEM settings\Proc. outputs`.
- Press ENTER.

`Special Funct.\SYSTEM settings\Proc. outputs\Loop I1,I2`

- Select `active` if all current outputs to be installed, are to be operated actively.
- Select `passive` if all current outputs to be installed, are to be operated passively.
- Press ENTER.

Selection of an output

```
Special Funct.\SYSTEM settings\Proc. outputs\Install Output
```

- Select the output to be installed.
- Press ENTER.

The scroll list contains all available outputs of the transmitter:

- Current Ix (--)
- Binary Bx (--)
- Frequency Fx (--)

A tick (✓) after a list item indicates that this output has already been installed.

```
Special Funct.\SYSTEM settings\Proc. outputs\enable I1
```

- Select `yes` to install or reconfigure the output.
- Press ENTER.
- Select `no` to uninstall the output and to return to the previous menu item in order to select another output.
- Press ENTER.

Assignment of a measuring channel

```
Special Funct.\SYSTEM settings\Proc. outputs\...\Source chan. I1
```

- Select the measuring channel to be assigned to the output as the source channel in the scroll list.
- Press ENTER.

Assignment of a source item

One source item has to be assigned to each selected output.

```
Special Funct.\SYSTEM settings\Proc. outputs\...\Source item
```

- Select the physical quantity (source item) to be transmitted to the output by the source channel.
- Press ENTER.

If a binary output is configured, only the list items `Limit` and `Impuls` will be displayed.

The source items and their scroll lists are summarized in the Tab. 9.1.

Tab. 9.1: Configuration of the outputs

source item	list item	output
Measuring value	actual measure	physical quantity selected in the program branch Output Options
	Flow	flow, independent of the physical quantity selected in the program branch Output Options
	Heatflow	thermal energy rate, independent of the physical quantity selected in the program branch Output Options
Quantity	Q+	totalizer for the positive flow direction
	* actual measure	totalizer for the physical quantity selected in the program branch Output Options
	* Flow	flow totalizer
	* Heatflow	thermal energy rate totalizer
	Q-	totalizer for the negative flow direction
	* actual measure	totalizer for the physical quantity selected in the program branch Output Options
	* Flow	flow totalizer
	* Heatflow	thermal energy rate totalizer
	ΣQ	sum of the totalizers (positive and negative flow direction)
* actual measure	totalizer for the physical quantity selected in the program branch Output Options	
* Flow	flow totalizer	
* Heatflow	thermal energy rate totalizer	
Limit	R1	limit message (Alarm Output R1)
	R2	limit message (Alarm Output R2)
	R3	limit message (Alarm Output R3)

Tab. 9.1: Configuration of the outputs

source item	list item	output
Temperature	<p>is only available if a temperature input has been assigned to the channel</p> <p>$T_{\text{fluid}} \leftarrow (T_i)^*$</p> <p>$T_{\text{aux S/R}} \leftarrow (T_i)^*$</p> <p>$T_{\text{supply}} \leftarrow (T_i)^*$</p> <p>$T_{\text{return}} \leftarrow (T_i)^*$</p> <p>$T_{\text{s-Tr}} \leftarrow (T_i - T_j)^*$</p> <p>$T_{\text{r-Ts}} \leftarrow (T_i - T_j)^*$</p> <p>$T(3) \leftarrow (T_i)^*$</p> <p>$T(4) \leftarrow (T_i)^*$</p> <p>* i, j: number of the assigned temperature input</p>	<p>fluid temperature measured by the temperature probe at the point where the flow is measured</p> <p>fluid temperature measured by the other temperature probe</p> <p>supply temperature</p> <p>return temperature</p> <p>difference between supply and return temperature</p> <p>difference between return and supply temperature</p> <p>third temperature input of the measuring channel</p> <p>fourth temperature input of the measuring channel</p>
Impuls	<p>from $\text{abs}(x)$</p> <p>from $x > 0$</p> <p>from $x < 0$</p>	<p>pulse without sign consideration</p> <p>pulse for positive measured values of the volumetric flow rate</p> <p>pulse for negative measured values for the volumetric flow rate</p>
Miscellaneous	<p>c-Medium</p> <p>SCNR</p> <p>Signal</p> <p>VariAmp</p> <p>Density</p> <p>Pressure</p>	<p>sound speed of the fluid</p> <p>ratio useful signal to correlated noise signal</p> <p>signal amplitude of a measuring channel</p> <p>standard deviation of the signal amplitude</p> <p>density of the fluid</p> <p>pressure of the fluid</p>

9.2.3.1 Output of the measured value

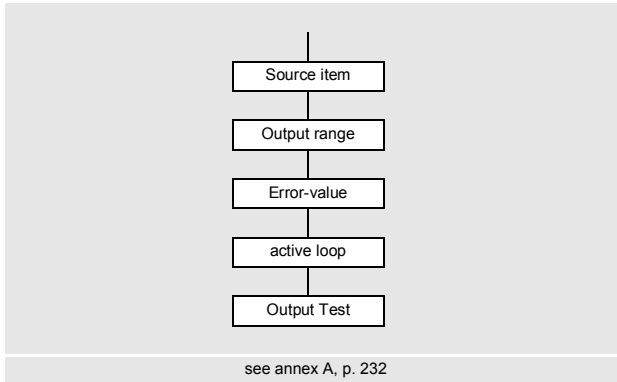

Output range

When configuring an analog output, the output range has to be defined.

```
Special Funct.\SYSTEM settings\Proc. outputs\...\Output range I1
```

- Select the menu item `Special Funct.\SYSTEM settings\Proc. outputs\...\I1 Output range`.
- Press ENTER.
- Select a list item.
 - `4/20 mA`
 - `other range`
- Press ENTER.
- If `other range` is selected, enter the values `Output MIN` and `Output MAX`.
- Press ENTER after each input.

Error output

```
Special Funct.\SYSTEM settings\Proc. outputs\...\Error-value I1
```

In the following dialog, an error value can be defined which is to be transmitted if the source item cannot be measured, e.g., if there are solids in the fluid.

- Select a list item for the error output, see Tab. 9.2.
- Press ENTER.
- If `Other value...` is selected, enter an error value. The value has to be within the output range.
- Press ENTER.

Notice!
The settings will be stored at the end of the dialog.

Tab. 9.2: Error output

error value	result
Minimum	the lower limit of the output range is output
Hold last value	the last measured value is output
Maximum	the upper limit of the output range is output
Other value...	The value has to be entered manually. It has to be within the limits of the output.

Example

source item: volumetric flow rate
 output: current output
 output range: 4...20 mA

error delay: $t_d > 0$

(see section 9.2.5 and Tab. 9.3)

The volumetric flow rate cannot be measured during the time interval $t_0...t_1$. The error value will be output.

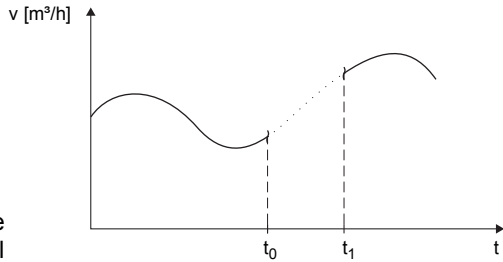

Tab. 9.3: Examples for the error output (output range: 4...20 mA)

list item	output signal
Minimum (4.0 mA)	

Tab. 9.3: Examples for the error output (output range: 4...20 mA)

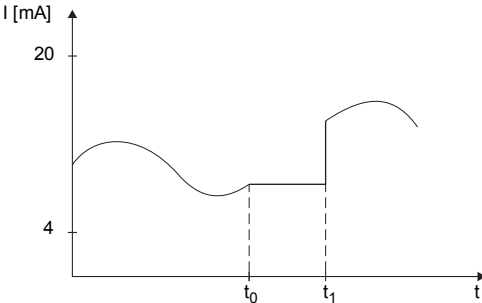
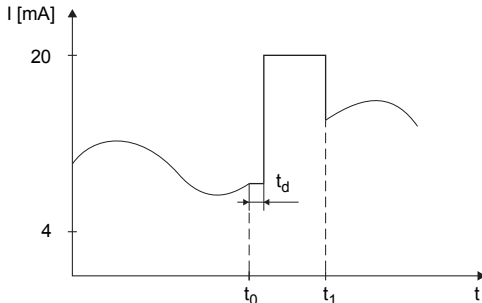
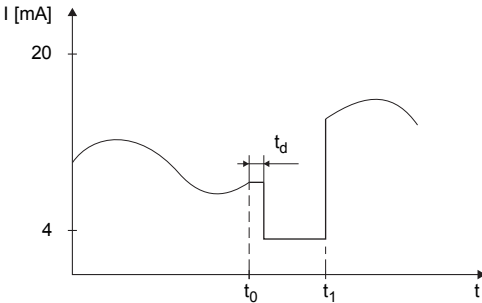
list item	output signal
Hold last value	 <p>The graph shows current I [mA] on the y-axis (ranging from 4 to 20) and time t on the x-axis. A sinusoidal wave is shown. At time t_0, the signal holds its last value. At time t_1, the signal jumps to a higher value and continues with the sinusoidal wave.</p>
Maximum (20.0 mA)	 <p>The graph shows current I [mA] on the y-axis (ranging from 4 to 20) and time t on the x-axis. A sinusoidal wave is shown. At time t_0, the signal jumps to the maximum value of 20 mA. At time t_1, it returns to the sinusoidal wave. A delay time t_d is indicated between t_0 and t_1.</p>
Other value... error value = 3.5 mA	 <p>The graph shows current I [mA] on the y-axis (ranging from 4 to 20) and time t on the x-axis. A sinusoidal wave is shown. At time t_0, the signal jumps to an error value of 3.5 mA. At time t_1, it returns to the sinusoidal wave. A delay time t_d is indicated between t_0 and t_1.</p>

Terminal assignment

```
Special Funct.\SYSTEM settings\Proc. outputs\...\I1 active loop
```

The terminals for the connection of the output are displayed.

- Press ENTER.

It will be displayed whether the current output is active or passive (here: active).

Output function test

The function of the output can now be tested.

- Connect an external measuring instrument to the terminals of the output.

```
Special Funct.\SYSTEM settings\Proc. outputs\...\I1 Output Test
```

- Enter a test value. It has to be within the output range.
- Press ENTER.

```
Special Funct.\SYSTEM settings\Proc. outputs\...\I1= 10 mA\Again?
```

If the external measuring instrument displays the entered value, the output functions correctly.

- Select **yes** to repeat the test, **no** to return to the menu item `SYSTEM settings`.
- Press ENTER.

9.2.4 Activation of an analog output

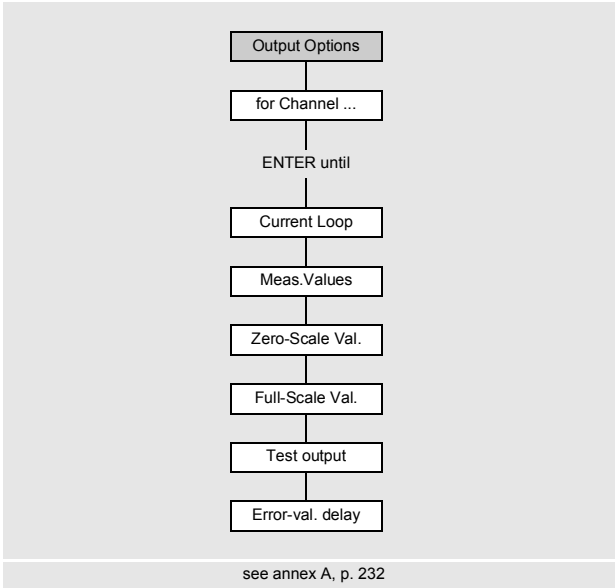

Notice!

An output can only be activated in the program branch `Output Options` if it has previously been installed.

`Output Options\for Channel A`

- Select the channel for which an output is to be activated in the program branch `Output Options`.
- Press ENTER.

`Output Options\...\Current Loop`

- Press ENTER until `Current Loop` is displayed.
- Select `yes` to activate the output.
- Press ENTER.

Measuring range

After an analog output has been activated in the program branch `Output Options`, the measuring range of the source item has to be entered.

```
Output Options\...\Meas.Values
```

- Select `sign` if the sign of the measured values is to be considered for the output.
- Select `absolut` if the sign of the measured values is not to be considered for the output.
- Press ENTER.

```
Output Options\...\Zero-Scale Val.
```

- Enter the lowest expected measured value. The unit of measurement of the source item will be displayed.

`Zero-Scale Val.` is the value assigned to the value `Output MIN` of the output range.

- Press ENTER.

```
Output Options\...\Full-Scale Val.
```

- Enter the highest expected measured value. The unit of measurement of the source item will be displayed.

`Full-Scale Val.` is the value assigned to the value `Output MAX` of the output range.

- Press ENTER.

Example

output: current output

output range: 4...20 mA

`Zero-Scale Val.:` 0 m³/h

`Full-Scale Val.:` 300 m³/h

volumetric flow rate = 0 m³/h, corresponds to 4 mA

volumetric flow rate = 300 m³/h, corresponds to 20 mA

Function test

The function of the output can now be tested.

- Connect an external measuring instrument to the terminals of the output.

```
Output Options\...\I1:Test output?
```

- Select `yes` to test the output.
- Press ENTER.

```
Output Options\...\I1:Test value
```

- Enter a test value for the selected physical quantity. If the external measuring instrument displays the entered value, the output functions correctly.
- Press ENTER.

```
Output Options\...\I1:Test output?
```

- Select `yes` to repeat the test.
- Press ENTER.

Example

output: current output

output range: 4...20 mA

Zero-Scale Val.: 0 m³/h

Full-Scale Val.: 300 m³/h

Test value = 150 m³/h (center of the measuring range, corresponds to 12 mA)

If the multimeter displays 12 mA, the current output functions correctly.

9.2.5 Input of the error delay

The error delay is the time after which an error value will be sent to an output if no valid measured values are available.

```
Output Options\...\I1>Error-val. delay
```

This display will only be indicated if the list item `edit` is selected in the menu item `Special Funct.\Dialogs/Menus/Error-val. delay`.

If the error delay is not entered, the damping factor will be used.

- Enter a value for the error delay.
- Press ENTER.

9.3 Start of the measurement

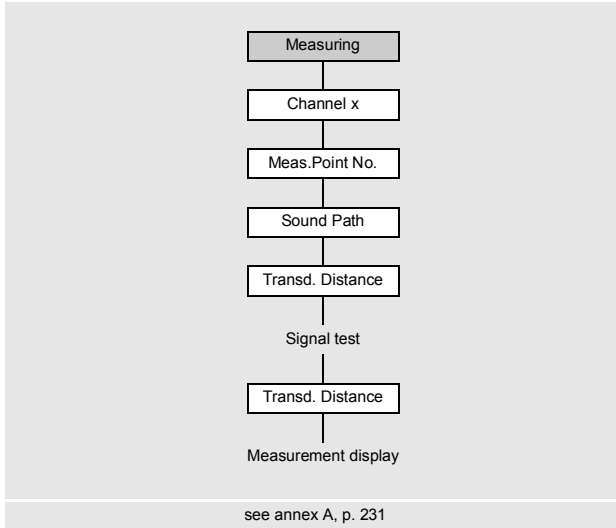

- Select the program branch `Measuring`.
- Press ENTER.

If the parameters in the program branch `Parameter` are not valid or incomplete, the error message `NO DATA!` will be displayed.

Activation of the channels

```
Measuring\Channel ...
```

The channels for the measurement can be activated and deactivated.

- ✓ the channel is activated
- the channel is deactivated
- the channel cannot be activated

Notice!

A channel cannot be activated if the parameters are not valid, e.g., if the parameters in the program branch `Parameter` of the channel are not complete.

- Select a channel with key `<4>` or `<6>`.
- Press key `<8>` to activate or deactivate the channel.
- Press ENTER.

A deactivated channel will be ignored during the measurement. The parameters entered for this channel will remain unchanged.

- If the data logger or the serial interface is activated, the measuring point number has to be entered:

Input of the measuring point number

```
Measuring\Channel\Meas.Point No.
```

- Enter the number of the measuring point.
- Press ENTER.

For the activation of text input, see `Special Funct.\SYSTEM settings\Dialogs/Menu\Meas.Point No.`

Input of the sound path number

```
Measuring\Channel\...\Sound Path
```

A value for the number of sound paths corresponding to the connected transducers and the entered parameters is recommended.

- Change the value, if necessary.
- Press ENTER.

Profile correction

If `With disturbance` is selected in the menu item `Special Funct.\SYSTEM settings\Measuring\ProfileCorr 2.0`, it has to be checked whether the measurement arrangement is appropriate.

If the number of sound paths is odd and more than one measuring channel is activated, the following display appears:

```
A: Alone at measp
>NO<           yes
```

- Select `no` if there are 2 transducer pairs in X arrangement or displaced X arrangement at the measuring point (appropriate measurement arrangement). The profile correction 2.0 at non ideal inflow conditions will be used. Transverse flow effects will be compensated.
- Select `yes` if there is only one transducer pair at the measuring point (inappropriate measurement arrangement). The profile correction 2.0 at non ideal inflow conditions cannot be used. The profile correction 2.0 at ideal inflow conditions will be used. Transverse flow effects will not be compensated.
- Press ENTER.

If **yes** is selected, the following menu messages are displayed:

```
Disturb correct.
not applicable!
```

```
I assume ideal
inlet conditions
```

Adjustment of the transducer distance

```
Measuring\...\Transd. Distance
```

The recommended transducer distance will be displayed.

- Mount the transducers on the pipe adjusting the transducer distance.
- Press ENTER.

A – measuring channel

Reflec – reflection arrangement

Diagon – diagonal arrangement

The transducer distance is measured between the inner edges of the transducers.

In case of a measurement in diagonal mode on very small pipes, a negative transducer distance is possible.

Notice!

The accuracy of the recommended transducer distance depends on the accuracy of the entered pipe and fluid parameters.

The diagnostics window is displayed, see Fig. 9.1.

Fine adjustment of the transducer distance

- If the displayed transducer distance is adjusted, press ENTER.

The measuring run for the positioning of the transducers is started.

The bar graph $s=$ shows the amplitude of the received signal, see Fig. 9.1.

- Shift one of the transducers slightly within the range of the recommended transducer distance until the bar graph reaches the max. length (6 squares).

Fig. 9.1: Diagnostics window

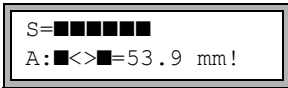

The following quantities can be displayed in the upper line by pressing key 9 and in the lower line by pressing key 3, see Fig. 9.2:

- ■<>■: transducer distance
- time: transit time of the measuring signal in μs
- S: signal amplitude
- Q: signal quality, bar graph has to have max. length

If the signal is not sufficient for a measurement, $Q = \text{UNDEF}$ will be displayed.

Fig. 9.2: Diagnostics window

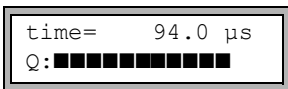
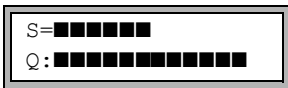

In case of large deviations, check if the entered parameters are correct or repeat the measurement at a different point on the pipe.

```
Measuring\...\Transd. Distance\54 mm
```

After the precise transducer positioning, the recommended transducer distance is displayed again.

- Enter the current (exact) transducer distance.
- Press ENTER.

Repeat the steps for all channels on which a measurement is made. The measurement will be started automatically.

Consistency check

If a wide range for the sound speed has been entered in the program branch `Parameter` or the exact parameters of the fluid are unknown, a consistency check is recommended.

The transducer distance can be displayed during the measurement by scrolling the key 9.

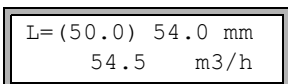

The optimum transducer distance is displayed in brackets (here: 50.0 mm) in the upper line, followed by the entered transducer distance (here: 54.0 mm). The latter value has to correspond to the adjusted transducer distance.

- Press ENTER to optimize the transducer distance.

The optimum transducer distance is calculated on the basis of the measured sound speed. It is therefore a better approximation than the first recommended value which had been calculated on the basis of the sound speed range entered in the program branch `Parameter`.

If the difference between the optimum and entered transducer distance is less than specified in Tab. 9.4, the measurement is consistent and the measured values are valid. The measurement can be continued.

- If the difference is greater, adjust the transducer distance to the displayed optimum value.
- Afterwards, check the signal quality and the signal amplitude bar graph.
- Press ENTER.

Tab. 9.4: Standard values for signal optimization

transducer frequency (3rd character of the technical type)	difference between the optimum and the entered transducer distance [mm]	
	shear wave transducer	Lamb wave transducer
F	-	-60...+120
G	20	-45...+90
H	-	-30...+60
K	15	-20...+40
M	10	-10...+20
P	8	-5...+10
Q	6	-3...+5
S	3	-

Notice!

If the transducer distance is changed during the measurement, the consistency check has to be repeated once again.

Repeat the steps for all channels on which a measurement is made.

9.4 Display of measured values

The measured values are displayed during the measurement as follows:

A:Volume flow
31.82 m3/h

9.4.1 Value of the sound speed

The sound speed of the fluid can be displayed during the measurement by pressing key .

If an approximate range for the sound speed has been entered in the program branch `Parameter` and the transducer distance has been optimized afterwards, it is recommended to write down the sound speed for the next measurement. By doing this, it will not be necessary to repeat the fine adjustment.

Write down the fluid temperature as the sound speed depends on it. The value can be entered in the program branch `Parameter`.

9.4.2 Toggling between the channels

If more than one measuring channel is available/activated, the transmitter works with an integrated multiplexer providing simultaneous measurement on the different measuring channels.

The flow rate is measured on one measuring channel for approx. 1 s, then the multiplexer switches to the next activated channel.

The time necessary for the measurement depends on the measuring conditions. If the measuring signal e.g., cannot be detected immediately, the measurement duration might be > 1 s.

The outputs and the serial interface continuously receive the measured values of the corresponding channel. The results are displayed according to the currently selected output options. The predefined unit of measurement of the volume flow rate is m^3/h .

The display of the measured values can be adjusted as follows:

- AutoMux mode
 - all channels
 - measuring channels only
 - calculation channels only
- HumanMux mode

Press key to toggle between the modes.

AutoMux mode

- All channels

The measured values of all activated channels (measuring and calculation channels) are displayed consecutively. The display and the measuring process are synchronized. The channel on which a measurement is being made is displayed in the upper line on the left.

- **Measuring channels only**
The measured values of all measuring channels are displayed. The next active measuring channel is selected after min. 1.5 s.
- **Calculation channels only**
The measured values of all calculation channels are displayed. The next active calculation channel is displayed after min. 1.5 s.
This mode can only be activated if at least 2 calculation channels are active.

HumanMux mode

The measured values of one channel are displayed in the HumanMux mode. The measurement on the other channels is continued, but not displayed.

Press key to display the next activated channel. The measured values for the selected channel are displayed.

9.4.3 Adjustment of the display

During the measurement, the display can be adapted in order to display 2 measured values at the same time (one in each line of the display). This does not affect totalizing, storing of measured values, transmission of measured values, etc.

The following information can be displayed in the upper line:

display	explanation
BATT	charge state of the battery
Mass Flow	designation of the physical quantity
A: +8.879 m ³	values of the totalizers, if activated
Tx	temperatures assigned to the channel and their difference if the temperature is measured
full	date and time at which the data logger will be full, if activated
Mode	measuring mode
L	transducer distance
Transd.	transducer temperature
Rx	alarm state indication if activated and if alarm outputs are activated
δc	difference between the measured sound speed and the sound speed of a selected reference fluid, if activated

The measured values of the physical quantity selected in the program branch **Output Options** can be displayed in the lower line:

display	explanation
12.3 m/s	flow velocity
1423 m/s	sound speed
124 kg/h	mass flow rate
15 m ³ /h	volumetric flow rate
12 kW	thermal energy rate

Press key **9** during the measurement to change the display in the upper line, press key **3** to change the display in the lower line.

```
A:Flow Velocity
*   2.47      m/s
```

The character * indicates that the displayed value (here: flow velocity) is not the selected physical quantity.

Status line

Important information of the running measurement is summarized in the status line. Quality and precision of the running measurement can be evaluated accordingly.

Press key **9** during the measurement to scroll through the upper line to the status line.

Fig. 9.3: Display of the status line

```
A: S3 Q9 c✓ RT F↓
```

Tab. 9.5: Description of the status line

	value	explanation
S		signal amplitude
	0	< 5 %

	9	≥ 90 %
Q		signal quality
	0	< 5 %

	9	≥ 90 %
c		sound speed comparison of the measured and the expected sound speed of the fluid The expected sound speed is calculated from the fluid parameters.
	√	OK, is equal to the expected value
	↑	> 20 % of the expected value
	↓	< 20 % of the expected value
	?	unknown, cannot be measured
R		flow profile information about the flow profile based on the Reynolds number
	T	fully turbulent flow profile
	L	fully laminar flow profile
	↕	transition range between laminar and turbulent flow
	?	unknown, cannot be calculated
F		flow velocity comparison of the measured flow velocity with the flow limits of the system
	√	OK, the flow velocity is not within the critical range
	↑	the flow velocity is higher than the current limit
	↓	the flow velocity is lower than the current cut-off flow
	0	the flow velocity is within the limit range of the measuring method
?	unknown, cannot be measured	

9.4.4 Transducer distance

The transducer distance can be displayed during the measurement by scrolling the key .

Fig. 9.4: Display of the transducer distance

L= (51.2) 50.8 mm
54.5 m3/h

The optimum transducer distance (here: 51.2 mm) will be displayed in parentheses in the upper line, followed by the entered transducer distance (here: 50.8 mm).

The optimum transducer distance might change during the measurement (e.g., due to temperature fluctuations).

A deviation from the optimum transducer distance (here: 0.4 mm) will be compensated internally.







Notice!

Never change the transducer distance during the measurement.

9.5 Execution of special functions

Some key have multiple functions. They can be used to enter data, to navigate through scroll lists and to execute special functions, see Tab. 9.6.

Tab. 9.6: Key functions

key	function
	tooggling between the AutoMux and HumanMux mode
	totalizer display
	triggering snaps
	tooggling between the displays of the activated channels
	tooggling between the TransitTime and the FastFood mode
	tooggling between the TransitTime and the NoiseTrek mode
BRK	measurement stop
ENTER	display of diagnostic window

9.6 Determination of the flow direction

The flow direction in the pipe can be detected with the help of the displayed volumetric flow rate sign in conjunction with the arrow on the transducers:

- The fluid flows in the direction of the arrow if the displayed volumetric flow rate is positive (e.g., 54.5 m³/h).
- The fluid flows against the arrow direction if the displayed volumetric flow rate is negative (e.g., -54.5 m³/h).

9.7 Stop of the measurement

A measurement is stopped by pressing key BRK.

Notice!

Be careful not to stop a current measurement by inadvertently pressing key BRK.

10 Troubleshooting

Danger!



Risk of explosion when using the measuring instrument in explosive atmospheres (ATEX, IECEx)

This may result in personal or material damage or other dangerous situations.

→ Observe the "Safety instructions for the use in explosive atmospheres", see document SIFLUXUS_608.

Danger!



Risk of explosion when using the measuring instrument FLUXUS *608**-F2 in explosive atmospheres

This may result in personal or material damage or other dangerous situations.

→ Observe the "Safety instructions for the use in explosive atmospheres", see document SIFLUXUS_608F2.

Caution!



Touching hot or cold surfaces

This may result in injuries (e.g., thermal damages).

- Observe the ambient conditions at the measuring point during installation.
- Wear the required personal protective equipment.
- Observe the applicable rules.

If any problem appears which cannot be solved with the help of this operating instruction, contact our sales office and give a precise description of the problem. Specify the type, the serial number and the firmware version of the transmitter.

The display does not work at all or fails regularly

Check the contrast setting of the transmitter or enter the HotCode **555000** to set the display to medium contrast.

Check that the battery is inserted and charged. Connect the power supply unit. If the power supply is OK, the transducers or an internal component of the transmitter are defective. The transducers and the transmitter have to be sent to FLEXIM for repair.

The message "SYSTEM ERROR" is displayed

Press key BRK to return to the main menu.

If this message is displayed repeatedly, write down the number displayed in the lower line. Track down the situations when the error is displayed. Contact FLEXIM.

The backlight of the display does not work, but all other functions are available

The backlight is defective. This problem has no influence on other functions of the display. Send the transmitter to FLEXIM for repair.

The display in the lower line constantly toggles between different physical quantities

Automatic toggling of the display in the BTU mode is activated. For the deactivation of the automatic toggling, see section 21.3.

Date and time are wrong, the measured values are deleted when the transmitter is switched off

The data backup battery has to be replaced if the date and the time are reset or wrong or the measured values are deleted after the transmitter has been switched off and on. Send the transmitter to FLEXIM.

An output does not work

Make sure that the outputs are configured correctly. Check the function of the output. If the output is defective, contact FLEXIM.

10.1 Problems with the measurement

A measurement is not possible because no signal is received. A question mark is displayed after the physical quantity.

- Check whether the entered parameters are correct, especially the outer pipe diameter, the pipe wall thickness and the sound speed of the fluid. Typical errors: The circumference or the radius was entered instead of the diameter. The inner pipe diameter was entered instead of the outer pipe diameter.
- Check the number of sound paths.
- Make sure that the recommended transducer distance was adjusted when mounting the transducers.
- Make sure that an appropriate measuring point is selected and the number of sound paths was entered correctly.
- Try to establish a better acoustic contact between the pipe and the transducers.
- Enter a lower value for the number of sound paths. The signal attenuation might be too high due to a high fluid viscosity or deposits on the inner pipe wall.

The measuring signal is received but no measured values can be obtained

- A exclamation point (!) in the lower line on the right indicates that the defined upper limit of the flow velocity is exceeded and, therefore, the measured values are marked as invalid. The limit has to be adapted to the measuring conditions or the check has to be deactivated.
- If no exclamation point is displayed, a measurement at the selected measuring point is impossible.

Signal loss during the measurement

- If there is no measuring signal after the pipe had been run empty and refilled, contact FLEXIM.
- Wait a moment until the acoustic contact is reestablished. The measurement can be interrupted due to a temporarily higher proportion of gas bubbles and solids in the fluid.

The measured values substantially differ from the expected values

- Wrong measured values are often caused by wrong parameters. Make sure that the entered parameters are correct for the measuring point.

10.2 Measuring point selection

- Make sure that the recommended min. distance to any disturbance source is observed.
- Avoid measuring points with deposit formation in the pipe.
- Avoid measuring points in the vicinity of deformations and defects on the pipe as well as welds.
- Make sure the pipe surface at the selected measuring point is even.
- Measure the temperature at the measuring point and make sure that the transducers are suitable for this temperature.
- Make sure that the outer pipe diameter is within the measuring range of the transducers.
- When measuring on a horizontal pipe, the transducers have to be mounted laterally on the pipe.
- The measuring point on a vertically mounted pipe has always to be filled. The fluid should flow upward.
- No gas bubbles should form (even bubble-free fluids can form gas bubbles when the fluid expands, e.g., upstream of pumps and downstream of great cross-section enlargements).

10.3 Maximum acoustic contact

see section 6.2

10.4 Application-specific problems

A fluid with a wrong sound speed was selected

If the selected sound speed in the fluid does not match the actual one, the transducer distance can probably not be determined correctly.

The fluid sound speed is used to calculate the transducer distance and is therefore very important for the transducer positioning. The sound speeds stored in the transmitter only serve as an orientation.

The entered pipe roughness is not appropriate

Check the entered value. The pipe state should be considered.

Measurements on pipes made of porous materials (e.g., concrete or cast iron) are only conditionally possible

Contact FLEXIM.

The pipe lining may cause problems during the measurement if it is not firmly attached to the inner pipe wall or consists of acoustically absorbing material

Try to measure on a section of the pipe free from lining.

Highly viscous fluids strongly attenuate the ultrasonic signal

The measurement of fluids with a viscosity of $> 1000 \text{ mm}^2/\text{s}$ is only conditionally possible.

A high concentration of gases or solids in the fluid scatter and absorb the ultrasonic signal and thus attenuate the measuring signal

A measurement is impossible if the value is $\geq 10 \%$. If the proportion is high, but $< 10 \%$, a measurement is only conditionally possible.

10.5 Significant deviations of the measured values

A fluid with a wrong sound speed was selected

If a fluid was selected whose sound speed does not match the actual one, the measuring signal may be confused with the pipe wall signal.

The flow calculated on the basis of the wrong signal by the transmitter is very small or fluctuates around zero.

There is gas in the pipe

If there is gas in the pipe, the measured flow will be too high because both, the liquid and gas volume, are measured.

The defined upper limit of the flow velocity is too low

All measured flow velocities that are greater than the upper limit will be ignored and marked as invalid. All quantities deviated from the flow velocity will also be indicated as invalid. If several correct measured values are ignored, the totalizer values will be too low.

The entered cut-off flow is too high

All flow velocities below the cut-off flow are set to zero. All derived quantities are also set to zero. The cut-off flow has to be set to a low value to be able to measure at low flow velocities (default: 2.5 cm/s).

The entered pipe roughness is not appropriate**The flow velocity of the fluid is outside the measuring range of the transmitter****The measuring point is not appropriate**

Check whether a different measuring point provides better results. Because pipes are never rotationally symmetric, the flow profile is affected.

10.6 Problems with the totalizers

The values of the totalizers are too high

See `Special Funct.\SYSTEM settings\Measuring\Quantity recall`. If this menu item is activated, the values of the totalizer will be stored. The totalizer will continue with this value at the start of the next measurement.

The values of the totalizers are too small

One of the totalizers has reached the upper limit and has to be reset to zero manually.

The sum of the totalizers is not correct

See `Special Funct.\SYSTEM settings\Measuring\Quant. wrapping`. The sum of both totalizers (throughput) transmitted via the output is no longer valid after the first overflow (wrapping) of one of the totalizers.

10.7 Problems during the heat flow measurement

The measured values for the fluid temperature differ from the actual values.

The temperature probes are not sufficiently insulated.

On a pipe with a small pipe diameter, the temperature probe is lifted from the pipe surface by the insulation foam.

The measured absolute value of the heat flow is correct but has the opposite sign.

Check the assignment of the supply and return temperature to the temperature inputs.

The calculated heat flow differs from the actual heat flow although the measured flow and temperature values are correct

Check the heat flow coefficient of the fluid.

11 Maintenance and cleaning

Danger!



Risk of explosion when using the measuring instrument in explosive atmospheres (ATEX, IECEx)

This may result in personal or material damage or other dangerous situations.

- Observe the "Safety instructions for the use in explosive atmospheres", see document SIFLUXUS_608.

Danger!



Risk of explosion when using the measuring instrument FLUXUS *608-F2 in explosive atmospheres**

This may result in personal or material damage or other dangerous situations.

- Observe the "Safety instructions for the use in explosive atmospheres", see document SIFLUXUS_608F2.

Caution!



Touching hot or cold surfaces

This may result in injuries (e.g., thermal damages).

- Observe the ambient conditions at the measuring point during installation.
- Wear the required personal protective equipment.
- Observe the applicable rules.

11.1 Maintenance

The transmitter and the transducers are practically maintenance-free. In order to ensure security, the following maintenance intervals are recommended:

item	maintenance step	interval	measure
housing • transmitter	visual inspection for corrosion and damages	annually	cleaning, see section 11.2
	visual inspection for contamination	annually, depending on the ambient conditions more frequently	
transducers	check of the transducer coupling on the tube	annually	replacement of coupling foil, if necessary
transmitter	firmware check for updates	annually	update, if necessary
transmitter	functional test	annually	reading of measured and diagnostic values
transmitter and transducers	calibration	-	see section 11.3
transmitter	charge state of the battery	-	see section 7.1.2.1 (FLUXUS *601) or 7.2.2.1 (FLUXUS *608)

11.2 Cleaning

Housing

- Clean the housing with a soft cloth. Do not use detergents.

Transducers

- Remove traces of coupling compound from the transducers with a soft paper towel.

11.3 Calibration

If installed as recommended in an appropriate location, used cautiously and serviced conscientiously, no troubles should appear.

The transmitter has been calibrated at factory and, usually, a re-calibration of the transmitter is not necessary.

A re-calibration is recommended if:

- the contact surface of the transducers show visible wear or
- the transducers were used for a prolonged period at high temperatures (several months > 130 °C for normal transducers or > 200 °C for high temperature transducers)

In order to realize a recalibration under reference conditions either the transmitter, the transducers or the transmitter with transducers have to be sent to FLEXIM depending on which part needs to be calibrated.

12 Dismounting and disposal

Danger!



Risk of explosion when using the measuring instrument in explosive atmospheres (ATEX, IECEx)

This may result in personal or material damage or other dangerous situations.

→ Observe the "Safety instructions for the use in explosive atmospheres", see document SIFLUXUS_608.

Danger!



Risk of explosion when using the measuring instrument FLUXUS *608-F2 in explosive atmospheres**

This may result in personal or material damage or other dangerous situations.

→ Observe the "Safety instructions for the use in explosive atmospheres", see document SIFLUXUS_608F2.

12.1 Dismounting

The dismounting is carried out in reverse order to its installation, see chapter 6.

12.2 Disposal

The measuring equipment has to be disposed in accordance to the applicable regulations.

Depending on the material, the corresponding parts have to be disposed in residual or special waste or recycled. For further information, contact FLEXIM.

Notice!

Used batteries do not belong to the domestic waste. Consult national regulations and guidelines for returning used batteries. Used batteries can be returned free of charge to FLEXIM.

13 Outputs

13.1 Installation of an output when using the adapter for the active current input

If the transmitter has an active current output (FLUXUS *601 only), it can be used by means of an adapter as a power supply for a passive current sink (e.g., pressure transmitter) which is connected to a passive current input, see section 7.1.4 for the connection.

Installation of the output

```
Special Funct.\SYSTEM settings\Proc. outputs
```

- Select the menu item `Special Funct.\SYSTEM settings\Proc. outputs`.
- Press ENTER.

```
Special Funct.\SYSTEM settings\Proc. outputs\Loop I1,I2
```

- Select `active`.
- Press ENTER.

```
Special Funct.\SYSTEM settings\Proc. outputs\Install Output
```

- Select a current output.
- Press ENTER.

A tick (✓) after a list item indicates that this output has already been installed.

```
Special Funct.\Proc. outputs\...\As energy helper
```

- Select `yes`.
- Press ENTER.

After starting the measurement, the current output is set to 24 mA.

Terminal assignment

```
Special Funct.\SYSTEM settings\Proc. outputs\...\Active loop I1
```

The terminals for the connection of the output are displayed.

- Press ENTER.

Output function test

The function of the output can now be tested.

```
Special Funct.\SYSTEM settings\Proc. outputs\...\Energy helper I1
```

- Connect a voltmeter to the terminals of the installed output.
- Press ENTER.

```
Special Funct.\SYSTEM settings\Proc. outputs\...\Check volt. now?
```

If the voltmeter is within the range $25.5 \text{ V} \pm 2.5 \text{ V}$, the output works correctly.

13.2 Installation of a binary output

If the transmitter is equipped with binary outputs, they have to be installed and activated before they can be used:

- assignment of a measuring channel (source channel) to the binary output (if the transmitter has more than one measuring channel)
- assignment of the physical quantity (source item) to be transmitted to the output by the source channel, and the properties of the signal
- activation of the installed binary output in the program branch `Output Options`

Notice!

The settings will be stored at the end of the dialog. If the menu item is quit by pressing key BRK, the changes will not be stored.

```
Special Funct.\SYSTEM settings\Proc. outputs
```

- Select the menu item `Special Funct.\SYSTEM settings\Proc. outputs`.
- Press ENTER.

Selection of a binary output

```
Special Funct.\SYSTEM settings\Proc. outputs\Install Output
```

- Select the binary output to be installed.
- Press ENTER.

```
Special Funct.\SYSTEM settings\Proc. outputs\Enable B1
```

- Select **yes** to install or reconfigure the output.
- Press **ENTER**.
- Select **no** to uninstall the output and to return to the previous menu item in order to select another output.
- Press **ENTER**.

Assignment of a measuring channel

```
Special Funct.\SYSTEM settings\Proc. outputs\...\Source chan. B1
```

- Select the measuring channel to be assigned to the output as the source channel in the scroll list.
- Press **ENTER**.

Assignment of a source item

One source item has to be assigned to each selected output.

```
Special Funct.\SYSTEM settings\Proc. outputs\...\Source item
```

- Select the physical quantity (source item) to be transmitted to the binary output by the source channel.
- Press **ENTER**.

The source items and their scroll lists are summarized in the following table.

Tab. 13.1: Configuration of the binary outputs

source item	list item	output
Limit	R1	limit message (Alarm Output R1)
	R2	limit message (Alarm Output R2)
	R3	limit message (Alarm Output R3)
Impuls	from $\text{abs}(x)$	pulse without sign consideration
	from $x > 0$	pulse for positive measured values of the volumetric flow rate
	from $x < 0$	pulse for negative measured values for the volumetric flow rate

Function test of the binary output

The function of the output can now be tested.

- Connect an external measuring instrument to the terminals of the output.

```
Special Funct.\SYSTEM settings\Proc. outputs\...\Output Test B1\  
Opto-Relay OFF
```

- Select `Opto-Relay OFF` in the scroll list `Output Test` to test the de-energized state of the output.
- Press ENTER. Measure the resistance at the output. The value has to be high ohmic.

```
Special Funct.\...\Output Test B1\B1=ON\Again?
```

- Select `yes` to repeat the test, `no` to return to the menu item `SYSTEM settings`.
- Press ENTER.

```
Special Funct.\SYSTEM settings\Proc. outputs\...\Output Test B1\  
Opto-Relay ON
```

- Select `Opto-Relay ON` in the scroll list `Output Test` to test the energized state of the output.
- Press ENTER. Measure the resistance at the output. The value has to be low ohmic.

```
Special Funct.\...\Output Test B1\B1=ON\Again?
```

- Select `yes` to repeat the test, `no` to return to the menu item `SYSTEM settings`.
- Press ENTER.

13.3 Configuration of a frequency output as pulse output

A frequency output sends a signal with a frequency that depends on the volumetric flow rate. The frequency output can be configured in such way that the source item can be totalized by using each period of the output signal as the increment.

Installation of a frequency output (optional)

```
Special Funct.\SYSTEM settings\Proc. outputs\Install Output
```

- Select the frequency output to be installed.
- Press ENTER.

```
Special Funct.\SYSTEM settings\Proc. outputs\Enable F1
```

- Select *yes* to install or reconfigure the output.
- Press ENTER.
- Select *no* to uninstall the output and to return to the previous menu item in order to select another output.
- Press ENTER.

```
Special Funct.\SYSTEM settings\Proc. outputs\...\Source chan. F1
```

- Select the measuring channel to be assigned to the frequency output as the source channel in the scroll list.
- Press ENTER.

This display will not be indicated if the transmitter has only one measuring channel. This display will not be indicated if the transmitter has only one measuring channel.

```
Special Funct.\SYSTEM settings\Proc. outputs\...\Source item\
Measuring value
```

- Select as source item *Measuring value* in the scroll list (but not *Impuls*).
- Press ENTER.

```
Special Funct.\SYSTEM settings\Proc. outputs\...\Setup as pulse ?
```

If *Measuring value* is selected and the source item can be totalized, a request will be indicated whether the frequency output is to be configured as a pulse output.

- Select *yes*.
- Press ENTER.

```
Special Funct.\SYSTEM settings\Proc. outputs\...\Output MAX F1
```

- Enter the upper limit of the frequency.
- Press ENTER.

The lower limit of the frequency and the error value will be set automatically to 0.5 Hz.

Activation of a frequency output

```
Output Options\for Channel A
```

- Select the channel for which the output is to be activated in the program branch Output Options.
- Press ENTER.

This display will not be indicated if the transmitter has only one measuring channel. This display will not be indicated if the transmitter has only one measuring channel.

```
Output Options\...\Frequency Output
```

- Press ENTER until Frequency Output is displayed.
- Select *yes* to activate the output.
- Press ENTER.

```
Output Options\...\Frequency Output\Pulses per unit
```

- Enter the number of pulses that is to be assigned to the unit of measurement of the totalizer.
- Press ENTER.

Example: 1000 pulses correspond to 1 m³ of the totalized fluid.

```
Output Options\...\Frequency Output\INFO: max flow= 3600.0 m3/h
```

The max. flow depending on the upper limit of the frequency and pulse value is indicated.

- Press ENTER.

13.4 Activation of a binary output as pulse output

A pulse output is an integrating output which emits a pulse when the volume or the mass of the fluid which has passed the measuring point reaches a given value (`Pulse Value`). The integrated quantity is the selected physical quantity. Integration is restarted as soon as a pulse is emitted.

Notice!

The menu item `Pulse Output` will only be indicated in the program branch `Output Options` if a pulse output has been installed.

```
Output Options\for Channel A
```

- Select the channel for which the output is to be activated in the program branch `Output Options`.
- Press ENTER.

```
Output Options\...\Pulse Output
```

- Press ENTER until `Pulse Output` is displayed. Select `yes` to activate the output.
- Press ENTER.

```
Output Options\...\Pulse Output\NO COUNTING
```

This error message will be displayed if the flow velocity is selected as the physical quantity.

The use of the pulse output is not possible in this case because the integration of the flow velocity does not result in a reasonable value.

```
Output Options\...\Pulse Output\Pulse Value
```

- Enter the pulse value. The unit of measurement will be displayed according to the actual physical quantity.

When the counted physical quantity reaches the entered pulse value, a pulse will be transmitted.

- Press ENTER.

Output Options\...\Pulse Output\Pulse Width

- Enter the pulse width.

The range of possible pulse widths depends on the specification of the instrument (e.g., counter, PLC) that is to be connected to the output.

- Press ENTER.

The max. flow the pulse output can work with will be displayed now. This value is calculated on the basis of the entered pulse value and pulse width.

If the flow exceeds this value, the pulse output does not work correctly. In this case, the pulse value has to be increased.

- Press ENTER.

14 Inputs

Transducers of other manufacturers can also be connected to the inputs (option) in order to measure the following physical quantities:

- temperature
- density
- pressure
- kinematic viscosity
- dynamic viscosity

The values of the current, voltage, and temperature inputs can be used by all measuring channels.

An input has to be assigned to a measuring channel and activated before it can be used for the measurement and for the storing of measured values.

```
Special Funct.\SYSTEM settings\Proc. inputs
```

- Select the menu item `Special Funct.\SYSTEM settings\Proc. inputs`.
- Press ENTER.

Depending on the configuration of the transmitter, one or several of the following list items will be displayed:

Tab. 14.1: List items for `Proc. inputs`

list item	function
Link temperature	assignment of temperature inputs to measuring channels
Link other inp.	assignment of other inputs to measuring channels
Pt100 / Pt1000	selection of a temperature probe
...go back	return to the previous menu item

14.1 Assignment of the temperature inputs to the measuring channels

For the assignment of the temperature inputs during the thermal energy rate measurement see chapter 21.

```
Special Funct.\SYSTEM settings\Proc. inputs
```

- Select the menu item `Special Funct.\SYSTEM settings\Proc. inputs`.
- Press ENTER.
- Select the list item `Link temperature`.
- Press ENTER.

```
Special Funct.\SYSTEM settings\...\A:T-Inlet
```

- Select the temperature input to be assigned to measuring channel A as supply temperature.
- Select the list item `Fixed input val.` if the supply temperature is to be entered manually before the measurement.
- Select the list item `No measuring` if no supply temperature is to be assigned to measuring channel A.
- Press ENTER.

```
Special Funct.\SYSTEM settings\...\T-Fluid/Outle\Input T1
```

- Select the temperature input to be assigned to measuring channel A as fluid temperature. The temperature value will be used for the calculation of the selected physical quantity.
- Select the list item `Fixed input val.` if the temperature is to be entered manually before the measurement.
- Select the list item `No measuring` if no temperature is to be assigned to measuring channel A.
- Press ENTER.
- Select the list items `T(3)` and `T(4)` if additional temperature values besides the fluid temperature are to be measured and stored. These additional temperature values will not be used for the calculation of the selected physical quantity.
- Repeat the steps for the available measuring channel.
- Press ENTER after each input.

Notice!

The configuration of a measuring channel will be stored when the next channel is selected. The configuration dialog for a channel has to be completed in order to store the changes.

Selection of the temperature probe

```
Special Funct.\SYSTEM settings\Proc. inputs
```

- Select the menu item `Special Funct.\SYSTEM settings\Proc. inputs.`
- Press ENTER.

```
Special Funct.\SYSTEM settings\Proc. inputs\PT100/PT1000
```

- Select the list item PT100/PT1000.
- Press ENTER.

```
Special Funct.\SYSTEM settings\...\Input T1
```

- Select the temperature probe.
- Press ENTER.
- If necessary, select the temperature probe for Input T2...T4 accordingly.

14.2 Assignment of other inputs to the measuring channels

```
Special Funct.\SYSTEM settings\Proc. inputs
```

- Select the menu item Special Funct.\SYSTEM settings\Proc. inputs.
- Press ENTER.

```
Special Funct.\SYSTEM settings\Proc. inputs\Link other inp.
```

- Select the list item Link other inp.
- Press ENTER.

```
Special Funct.\SYSTEM settings\...\A:ext.Input(1)\Input I1
```

- Select the first input to be assigned to measuring channel A. Only the installed inputs are displayed in the scroll list.
- Select the list item No measuring if no input is to be assigned to measuring channel A.
- Press ENTER.

Select the list items for ext.Input(2)...(4) of the measuring channel A and all available channels accordingly.

Notice!

The configuration of a measuring channel will be stored when the next channel is selected. The configuration dialog for a channel has to be completed in order to store the changes.

14.3 Activation of the channels

The display for the activation of the inputs in the program branch `Output Options` will only be displayed if the transmitter has inputs of the corresponding type and they have been assigned to a measuring channel.

14.3.1 Activation of the temperature inputs

Notice!

If `Heatflow` is selected as the physical quantity, the corresponding temperature inputs will be activated automatically. The steps described below are only necessary if the measured temperatures are to be displayed or transmitted.

The temperature inputs have to be activated in case the measured temperature is to be displayed, stored and/or transmitted or if the measured temperature is to be used for the interpolation of the viscosity and the density of the fluid.

`Output Options\for Channel A`

- Select the channel for which an input is to be activated in the program branch `Output Options`.
- Press ENTER.

`Output Options\...\T1:Temperature`

- In the program branch `Output Options`, select the channel for which an temperature input is to be activated. The temperature inputs assigned to the channel will be displayed one after another.
- Select `yes` for the temperature inputs that are to be activated.
- Press ENTER.

Notice!

The total number of measured values that can be stored will be reduced if a temperature input is activated.

14.3.2 Activation of other inputs

Important!

Observe the correct polarity in order to avoid damaging the connected external transducer. A permanent short circuit can lead to the destruction of the current input.

Inputs have to be activated if the measured values are to be displayed, stored and/or transmitted together with the other measured values.

```
Output Options\for Channel A
```

- Select the channel for which an input is to be activated in the program branch `Output Options`.
- Press ENTER.

```
Output Options\...\I1:Input
```

- In the program branch `Output Options`, select the channel for which an input is to be activated. The inputs assigned to the channel will be displayed one after another.
- Select `yes` for the inputs to be activated.
- Press ENTER.

Notice!

The total number of measured values that can be stored will be reduced if a input is activated.

14.4 Temperature correction

A temperature correction (offset) can be set for each temperature input. If a correction value has been defined, it will be added automatically to the measured temperature. This function is useful if e.g.,:

- the characteristic curves of both temperature probes differ considerably from each other
- a known and constant temperature gradient exists between the measured temperature and the actual temperature

14.4.1 Activation/deactivation of the temperature correction

```
Special Funct.\SYSTEM settings\Dialogs/Menu
```

The temperature correction can be activated/deactivated in the program branch `Special Funct.\SYSTEM settings\Dialogs/Menu`.

```
Special Funct.\SYSTEM settings\Dialogs/Menu\Tx Corr.Offset
```

- Select `on` to activate the temperature correction, `off` to deactivate it.
- Press ENTER.

Notice!

If `off` is selected, the temperature correction will be deactivated for all inputs. However, the entered correction values for each temperature input will be stored and displayed again when the temperature correction is activated again.

14.4.2 Input of the temperature correction

During the flow transducer positioning, the correction values will be requested for each input which has been activated and where the temperature can be measured.

```
T1 Corr.Offset\0.3 C
```

- Enter the offset for the temperature input.
- Press ENTER.

Notice!

Only measured temperatures can be corrected.

In order to adjust the zero point, the same reference temperature is measured with both temperature probes. The difference of both measured temperatures is entered as the offset for one of the temperature inputs. The difference can also be distributed between the offsets of both channels.

The display of the temperature difference $T1-T2$ does not indicate if one or both temperatures are constant or if the values have been corrected.

During the measurement, a corrected temperature value is marked by `cor`.

Fig. 14.1: Display of the corrected temperature

T1=	90.5	(cor)
	0.0	kW

15 Data logger

The transmitter has a data logger which stores the following data during the measurement.

- date
- time
- measuring point number
- pipe parameters
- fluid parameter
- transducer data
- sound path (reflection or diagonal arrangement)
- transducer distance
- damping factor
- storage rate
- physical quantity
- unit of measurement
- values of the totalizers
- diagnostic values

In order to store the data, the data logger has to be activated.

The available data logger can be displayed.

The storing of each measured value will be signaled acoustically. The acoustic signal can be deactivated.

15.1 Activation/Deactivation of the data logger

```
Output Options\for Channel A
```

- Select the channel for which the output is to be activated in the program branch `Output Options`.
- Press ENTER.

```
Output Options\...\Store Meas.Data
```

- Press ENTER until `Store Meas.Data` is displayed.
- Select `yes` to activate the data logger, `no` to deactivate it.
- Press ENTER.

15.2 Setting the storage rate

The storage rate is the frequency to transmit or store measured values. The storage rate is set separately. If the storage rate is not set, the storage rate previously selected will be used.

The storage interval should be at least equal to the number of activated measuring channels, 4 s are recommended

```
Output Options\...\Storage Rate
```

- Select a storage rate or EXTRA.
- Press ENTER.

This display will only be indicated if Store Meas.Data and/or Serial Output are activated.

```
Output Options\...\Storage Rate\EXTRA
```

- Enter the storage rate if EXTRA was selected.
- Press ENTER.

15.3 Configuration of the data logger

```
Special Funct.\SYSTEM settings\Storing
```

- Select the menu item Special Funct.\SYSTEM settings\Storing.
- Press ENTER.

Ringbuffer

The setting of the ringbuffer influences the storing of measured values as soon as the data logger is full:

- If the ringbuffer is activated, the available data logger will be halved. The oldest measured values will be overwritten. Only the data logger memory that was free during the activation will be used by the ringbuffer. If more data logger memory is necessary, measured values in the data logger should be previously deleted.
- If the ringbuffer is deactivated, the storing of measured values will be stopped.

```
Special Funct.\SYSTEM settings\Storing\Ringbuffer
```

- Select ON to activate the ringbuffer.
- Press ENTER.

Storage mode

Special Funct.\SYSTEM settings\Storing\Storage mode

- Select the storage mode.
- Press ENTER.

If `sample` is selected, the current measured value will be used for the storing and online transmission of data.

If `average` is selected, the average of all values measured during a storage interval will be used for the storing and online transmission of data.

Notice!

The storage mode does not affect the outputs.

Notice!

Storage mode = average

The average of the physical quantity and other measurands assigned to the measuring channel, will be calculated.

If the storage rate < 5 s is selected, `sample` will be used.

If no average could be calculated over the complete storage interval, the value will be marked as invalid. The ASCII file will contain ??? for invalid average values of the data and ?UNDEF instead of invalid temperatures.

Totalizer storing

It is possible to store the currently displayed totalizer only or to store one value for each flow direction.

Special Funct.\SYSTEM settings\Storing\Quantity Storage

- Select `one` to store the currently displayed totalizer value only. This can apply for the positive and negative totalizer.
- Select `both` to store the totalizer values for both flow directions.
- Press ENTER.

Signal amplitude storing

```
Special Funct.\SYSTEM settings\Storing\Store Amplitude
```

- Select **on** to store the amplitude of the measured signal together with the measured values.
- Press ENTER.

Fluid sound speed storing

```
Special Funct.\SYSTEM settings\Storing\Store c-Medium
```

- Select **on** to store the fluid sound speed together with the measured values.
- Press ENTER.

Diagnostic values storing

```
Special Funct.\SYSTEM settings\Storing\Store diagnostic
```

- Select **on** to store the diagnostic values together with the measured values.
- Press ENTER.

Acoustic signal during the storing

Per default, an acoustic signal will be emitted every time a measured value is stored or transmitted to a PC or printer.

```
Special Funct.\SYSTEM settings\Storing\Beep on storage
```

- Select **off** to deactivate the acoustic signal, **on** to activate it.
- Press ENTER.

Option of flow velocity storing

- Enter the HotCode **007043** immediately after the transmitter has been switched on.

```
Storage resolut.
auto          >FULL<
```

- Select **auto** to store the flow velocity as an integer. Select **full** to store the flow velocity as a floating-point number.
- Press ENTER.

15.4 Measurement with activated data logger

```
Measuring\Channel\Meas.Point No.
```

- Start the measurement.
- Enter the number of the measuring point.
- Press ENTER.

If Output Options\Store Meas.Data is activated and Special Funct.\SYSTEM settings\Ringbuffer is deactivated, a message indicating an error will be displayed as soon as the data logger is full.

```
DATA LOGGER IS FULL!
```

- Press ENTER.

The error message will be displayed periodically.

15.5 Deletion of measured values

```
Special Funct.\Delete Meas.Val.
```

- Select the menu item Special Funct.\Delete Meas.Val.
- Press ENTER.

```
Special Funct.\Delete Meas.Val.\Really Delete?
```

- Select yes or no.
- Press ENTER.

15.6 Information relating the data logger

According to the configuration of the data logger and the stored series of measured values, the available data logger will be displayed in the menu item Special Funct.\Instrum. Inform.

```
Special Funct.\Instrum. Inform.
```

- Select the menu item Special Funct.\Instrum. Inform.
- Press ENTER.

It is recommended to delete the old series of measured values before starting a measurement, see section 15.5.

Fig. 15.1: Information relating the data logger

```
x60x   -xxxxxxxxx
Free   18327
```

The type and the serial number of the transmitter are displayed in the upper line.

The available data logger will be displayed in the lower line (here: 18 327 additional measured values can be stored).

- Press key BRK twice to return to the main menu.

It is possible to store max. 100 series of measured values. The number of series of measured values depends on the total number of measured values stored in the previous series of measured values.

It is possible to display the time at which the data logger will be full during the measurement. All activated channels, totalizers and other values will be considered.

Press key to scroll through the display of the upper line.

```
full= 26.01/07:39
      54.5   m3/h
```

If the ringbuffer is activated and has overflown at least once, the following display will be indicated:

```
last= 26.01/07:39
      54.5   m3/h
```

16 Data transmission

The data can be transmitted to the transmitter via the service interface RS232.

Tab. 16.1: Data transmission overview

program	data transmission	see
FluxDiagReader	offline	section 16.1
FluxDiag (optional)	online or offline	section 16.1
terminal program	online or offline	section 16.2

16.1 FluxDiagReader/FluxDiag

With the help of FluxDiagReader and FluxDiag it is possible to display measurement data, snaps and parameter settings on the PC and to export them as csv file. In order to use FluxDiagReader, the measurement has to be stopped.

In addition to this, FluxDiag allows to analyze, to compare and to visualize measurement data as well as to create reports during the measurement. A permanent data transmission via FluxDiag is not recommended.

For the operation of the programs see FluxDiagReader support or FluxDiag support.

For the connection of the service interface see section 7.1.5.

16.2 Terminal program

If FluxDiag is not available, the measurement data can be transmitted to a terminal program in ASCII format.

16.2.1 Online transmission

The measured values are transmitted during the measurement.

The data logger works independently of the online transmission but with the same transmission rate.

- Start the terminal program.
- Enter the transmission parameters into the terminal program. The transmission parameters of the terminal program and the transmitter have to be identical, see section 16.3.

```
Output Options\for Channel A
```

- Select the program branch `Output Options`.
- Press ENTER.
- Select the channel for which the online transmission is to be activated.

```
Output Options\...\Serial Output
```

- Press ENTER until the menu item `Serial Output` is displayed.
- Select `yes` to activate the online transmission.
- Press ENTER.

```
Output Options\...\Serial Output\SEND ONLINE-HEAD
```

- Enter the storage rate.
- Start the measurement.

16.2.2 Offline transmission

Notice!

During the offline transmission only those data is transmitted that is stored in the transmitter.

- Start the terminal program.
- Enter the transmission parameters into the terminal program. The transmission parameters of the terminal program and the transmitter have to be identical, see section 16.3.

Transmitter settings

```
Special Funct.\Print Meas.Val.
```

- Select the menu item `Special Funct.\Print Meas.Val.`
- Press ENTER.

The following message will be displayed if no measured values are stored.

```
NO VALUES  
Print Meas.Val.
```

- Press ENTER.

The following message will be displayed if the measurement values are transmitted.

```
Send Header  
.....
```

The progress of the transmission of data is displayed by a bar graph.

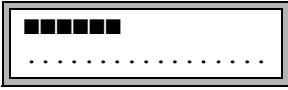

The following error message will be displayed if an error has occurred during the serial transmission.



- Press ENTER.
- Check the connections and make sure the PC is ready to receive data.

16.3 Transmission parameters

- the transmitter sends CRLF-terminated ASCII
- max. line length: 255 digits

RS232

default: 9600 bits/s, 8 data bits, even parity, 2 stop bits, protocol RTS/CTS (hardware, handshake)

The transmission parameters of the RS232 service interface can be changed.

- Enter HotCode **232-0**- immediately after the transmitter has been switched on.

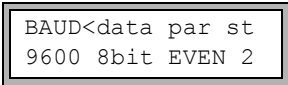

- Set the transmission parameters in the 4 scroll lists.
- Press ENTER.
 - baud: baud rate
 - data: number of data bits
 - par: parity
 - st: number of stop bits

16.4 Data format

```
Special Funct.\SYSTEM settings\Serial transmis.\SER:kill spaces
```

- Select the menu item Special Funct.\SYSTEM settings\Serial transmis.
- Press ENTER until SER:kill spaces is displayed.
- Select on if the space characters are not to be transmitted.
- Press ENTER.

The file size will be considerably smaller (shorter transmission time).

```
Special Funct.\SYSTEM settings\Serial transmis.\SER:decimalpoint
```

- Select the decimal marker to be used for floating-point numbers (point or comma).
- Press ENTER.

This setting depends on the setting of the operating system of the PC.

```
Special Funct.\SYSTEM settings\Serial transmis.\SER:col-separat.
```

- Select the character to be used to separate columns (semicolon or tabulator).
- Press ENTER.

16.5 Data structure

First, the header is transmitted. The first 4 lines contain general information about the transmitter and the measurement. The following lines contain the parameters for each channel.

Example

```

\DEVICE           : F60x -XXXXXXXXX
\MODE            : ONLINE
DATE            : 2018-01-09
TIME           : 19:56:52
Par.Record
Meas.Point No. : A:F5050
Pipe
  Outer Diameter : 60.3 mm
  Wall Thickness : 5.5 mm
  Roughness      : 0.1 mm
  Pipe Material  : Carbon Steel
  Lining         : WITHOUT LINING
Medium          : Water
  Medium Temperat. : 38 C
  Fluid pressure  : 1.00 bar
Transducer Type : xxx
Sound Path      : 3 NUM
Transd. Distance : -15.6 mm
Damping         : 20 s
Full-Scale Val. : 4.50 m3/h
Physic. Quant.  : Volume flow
Unit Of Measure : [m3/h]/[m3]
Numb.Of Meas.Val : 100

```

Next, the line `\DATA` is transmitted. Followed by the column titles, see Tab. 16.2, for the corresponding channel. The measured values are transmitted afterwards.

Example

```

\DATA
A: \*MEASURE; Q_POS; Q_NEG;
B: \*MEASURE; Q_POS; Q_NEG;

```

Depending on the storage interval, one data line per activated measuring channel is transmitted. The line "???" will be transmitted if there are no measured values available for the storage interval.

Example

With a storage interval of 1 s, 10 lines with "???" will be transmitted if the measurement has been restarted after a 10 s interruption for the positioning of the transducers.

The following data columns can be transmitted:

Tab. 16.2: Data columns

column title	column format	content
*MEASURE	###000000.00	physical quantity selected in the program branch Output Options
Q_POS	+00000000.00	totalizer value for the positive flow direction
Q_NEG	-00000000.00	totalizer value for the negative flow direction
FQ_POS		value of the totalizer for the positive flow direction (if the thermal energy rate is selected as physical quantity)
FQ_NEG		value of the totalizer for the negative flow direction (if the thermal energy rate is selected as physical quantity)
T1	###000.0	temperature T1 (= supply temperature if the thermal energy rate has been selected as physical quantity)
T2	###000.0	temperature T2 (= return temperature if the thermal energy rate has been selected as physical quantity)
...		designation for other inputs
SSPEED		sound speed of the fluid
AMP		signal amplitude

Online transmission

Columns will be created for all quantities appearing during the measurement. The columns Q_POS and Q_NEG remain empty if the totalizers are deactivated.

As the totalizers cannot be activated for the physical quantity "flow velocity", these columns will not be generated.

Offline transmission

During the offline transmission of data, columns will only be created if at least one measured value is stored in the data set. The columns Q_POS and Q_NEG will not be generated if the totalizers are deactivated.

17 Advanced functions





17.1 Totalizers

The thermal energy, total volume or total mass of the fluid at the measuring point can be determined.

There are 2 totalizers, one for the positive and the other for the negative flow direction. The unit of measurement used for totalizing corresponds to the heat, volume or mass unit selected for the physical quantity.

The totalizer values can be displayed with up to 11 places, e.g., 74890046.03. For the adjustment of the decimal places (max. 4), see section 18.7.

Tab. 17.1: Functions to display the totalizers

activation	press key  during the measurement
deactivation	press key  3 times during the measurement
display of the flow totalizer for the positive flow direction	press key  during the measurement
display of the flow totalizer for the negative flow direction	press key  during the measurement
toggling of totalizer display between positive and negative flow direction	Select the menu item <code>Special Funct.\SYSTEM settings\Measuring\Toggle totalizer</code> . Enter a time interval between 0 (off) and 5 s.
reset of the totalizers to zero	press key  3 times during the measurement

Notice!

The totalizers can only be activated for the measuring channel whose measured values are currently displayed.

Notice!

The pressing of a key will only influence the flow totalizers of the measuring channel whose measured values are currently displayed.

Automatic display toggling

The automatic toggling of the totalizer display between positive and negative flow direction can be set.

```
Special Funct.\SYSTEM settings\Measuring\Toggle totalizer
```

- Enter a time interval between 0 (off) and 5 s.
- Press ENTER.

Totalizer storing

It is possible to store the currently displayed totalizer only or to store one value for each flow direction.

```
Special Funct.\SYSTEM settings\Storing\Quantity Storage
```

- Select the menu item `Special Funct.\SYSTEM settings\Storing\Quantity Storage`.
- Press ENTER.
- If `one` is selected, only the value of the totalizer currently displayed will be stored. This can apply for the positive and negative totalizer.
- If `both` is selected, the values of the totalizers for both flow directions will be stored.
- Press ENTER.

Totalizer behavior during the thermal energy rate measurement

It is possible to output and store the values of the thermal energy totalizer and the volume totalizer during thermal energy rate measurement. Select the menu item `Special Funct.\SYSTEM settings\Measuring\heat+flow quant`.

```
Special Funct.\SYSTEM settings\Measuring\heat+flow quant.
```

- Select `on` to store and output the values of the thermal energy and volume totalizer during the thermal energy rate measurement.
- Press ENTER.

Totalizer behavior after the measurement is stopped

The totalizer behavior when the measurement is stopped or after a reset of the transmitter is set in the menu item `Special Funct.\SYSTEM settings\Measuring\Quantity recall`.

```
Special Funct.\SYSTEM settings\Measuring\Quantity recall
```

- If `on` is selected, the values of the flow totalizers will be stored and used for the next measurement.
- If `off` is selected, the flow totalizers will be reset to zero.
- Press ENTER.

Totalizer overflow

The overflow behavior of the totalizers can be set:

```
Special Funct.\SYSTEM settings\Measuring\Quant. wrapping
```

- Select the menu item `Special Funct.\SYSTEM settings\Measuring\Quant. wrapping`.
- Select `on` to work with overflow.

The flow totalizer will be reset to zero automatically when ± 999999999 is reached.

- Select `off` to work without overflow.

The value of the totalizer increases to the internal limit of 10^{38} . The values will be displayed as exponential numbers ($\pm 1.00000E10$), if necessary. The flow totalizer can only be reset to zero manually.

- Press ENTER.

Independent of the setting, the flow totalizers can be reset to zero manually.

Notice!

The overflow of a totalizer influences all output channels, e.g., data logger, online transmission of data.

The output sum of both totalizers (throughput ΣQ) transmitted via an output is not valid after the first overflow (wrapping) of one of the totalizers.

In order to signalize the overflow of a totalizer, an alarm output with the switching condition `QUANT.` and the type `HOLD` has to be activated.

17.2 NoiseTrek parallel beam mode

The NoiseTrek parallel beam mode works with parallel mounted transducers. It improves the signal quality when measuring on small pipes or with strongly attenuating fluids.

```
Special Funct.\SYSTEM settings\Measuring\Enable NoiseTrek
```

- Select the menu item `Special Funct.\SYSTEM settings\Measuring`.
- Press ENTER until the menu item `Enable NoiseTrek` is displayed.
- Select `on` to enable the NoiseTrek mode, `off` to disable it.
- Press ENTER.

```
Special Funct.\SYSTEM settings\Measuring\Enable NoiseTrek\  
NT parallel beam
```

- Select `on` to enable the NoiseTrek parallel beam mode, `off` to disable it.
- Press ENTER.

This display will only be indicated if the NoiseTrek mode is enabled.

17.3 HybridTrek mode

The HybridTrek mode combines the TransitTime and the NoiseTrek mode. During a measurement in the HybridTrek mode, the transmitter automatically toggles between the TransitTime and the NoiseTrek mode depending on the gaseous or solid content in the fluid in order to receive valid measuring values.

Notice!

Due to its higher measuring accuracy, the TransitTime mode should be used preferentially over the NoiseTrek mode.

```
Special Funct.\SYSTEM settings\Measuring\Enable NoiseTrek
```

- Select the menu item `Special Funct.\SYSTEM settings\Measuring`.
- Press ENTER until the menu item `Enable NoiseTrek` is displayed.
- Select `on` to enable the NoiseTrek mode, `off` to disable it.
- Press ENTER.

```
Special Funct.\SYSTEM settings\Measuring\Enable NoiseTrek\
Auto NoiseTrek
```

- Select `no` to deactivate the automatic toggling between the `TransitTime` and the `NoiseTrek` mode. If `no` is selected, the `NoiseTrek` mode can only be activated and deactivated manually during the measurement.
- Select `yes` to activate the automatic toggling between the `TransitTime` and the `NoiseTrek` mode. If `yes` is selected, the `NoiseTrek` mode can also be activated and deactivated manually during the measurement.
- Press ENTER.

This display will only be indicated if the `NoiseTrek` mode is enabled and the `NoiseTrek` parallel beam mode has not been activated yet.

If the automatic toggling between the `TransitTime` and `NoiseTrek` mode is activated, the toggling parameters have to be configured.

```
Special Funct.\...\Auto NoiseTrek\TT-Failed |After →NoiseTrek
```

- Enter the time after which the transmitter has to toggle to the `NoiseTrek` mode if there are no valid measured values in the `TransitTime` mode. If zero is entered, the transmitter does not toggle to the `NoiseTrek` mode.
- Press ENTER.

```
Special Funct.\...\Auto NoiseTrek\NT-Failed |After →TransTime
```

- Enter the time after which the transmitter has to toggle from the `NoiseTrek` to the `TransitTime` mode if there are no valid measured values. If zero is entered, the transmitter does not toggle to the `TransitTime` mode.

If there are valid measured values in the `NoiseTrek` mode, the transmitter can periodically toggle to the `TransitTime` mode in order to check whether a measurement in the `TransitTime` mode is possible again. The time interval and the duration of the checking are set as follows:

```
Special Funct.\...\Auto NoiseTrek\NT-Ok,but |Each check TT
```

- Enter the time after which the transmitter has to toggle to the `TransitTime` mode. If zero is entered, the transmitter does not toggle to the `TransitTime` mode.
- Press ENTER.

```
Special Funct.\...\Auto NoiseTrek\Keep TT |For checking
```

- Enter the time after which the transmitter has to toggle from the TransitTime mode back to the NoiseTrek mode if there are no valid measured values.
- Press ENTER.

Example

```
TT-Failed →NoiseTrek: After 40s
NT-Failed →TransTime: After 60s
NT-Ok,but check TT: Each 300s
Keep TT checking: For 5s
```

If no measurement is possible in the TransitTime mode within 40 s, the transmitter toggles to the NoiseTrek mode. If no measurement is possible in the NoiseTrek mode within 60 s, the transmitter toggles back to the TransitTime mode.

If valid measured values are obtained during the measurement in the NoiseTrek mode, the transmitter toggles to the TransitTime mode every 300 s. If no measurement is possible in the TransitTime mode for the duration of 5 s, the transmitter toggles back to the NoiseTrek mode. If a valid measured value is obtained in the TransitTime mode within 5 s, the transmitter continues the measurement in the TransitTime mode.

In order to manually toggle between the TransitTime and the NoiseTrek mode during the measurement, press key  when the measuring mode is displayed.

17.4 Upper limit of the flow velocity

Single outliers caused by heavily disturbed surroundings can appear among the measured values of the flow velocity. If these outliers are not ignored, they will affect all derived physical quantities, which will be unsuitable for the integration (e.g., pulse outputs). It is possible to ignore all measured flow velocities exceeding the preset upper limit. These measured values will be marked as outliers.

The upper limit of the flow velocity is set in `Special Funct.\SYSTEM settings\Measuring\Velocity limit`.

```
Special Funct.\SYSTEM settings\Measuring\Velocity limit
```

- Enter zero to switch off the outliers check.
- Enter a limit > 0 to switch on the outliers check. The measured flow velocity will then be compared to the entered upper limit.
- Press ENTER.

If the flow velocity is higher than the upper limit,

- the flow velocity will be marked as invalid. The physical quantity cannot be determined.
- the LED of the measuring channel will light red
- a (!) will be displayed after the unit of measurement (in case of a normal error (?) is displayed).

Notice!

If the upper limit is too low, a measurement might be impossible because most of the measured values will be marked as invalid.

17.5 Cut-off flow

The cut-off flow is a lower limit for the flow velocity. All measured flow velocities that are lower than the limit and their derived quantities are set to zero.

The cut-off flow can depend on the flow direction. The cut-off flow is set in `Special Funct.\SYSTEM settings\Measuring\Cut-off Flow`.

```
Special Funct.\SYSTEM settings\Measuring\Cut-off Flow
```

- Select `sign` to define a cut-off flow depending on the flow direction. One limit is set for the positive and negative flow velocity.
- Select `absolut` to define a cut-off flow independent of the flow direction. A limit is set for the absolute value of the flow velocity.
- Press ENTER.
- Select `factory` to use the default limit of 2.5 cm/s (0.025 m/s) for the cut-off flow.
- Select `user` to enter the cut-off flow.
- Press ENTER.

If `Cut-off Flow\sign` and `user` are selected, 2 values have to be entered:

```
Special Funct.\...\+Cut-off Flow
```

- Enter the cut-off flow.
- Press ENTER.

All positive values of the flow velocity smaller than this limit are set to zero.

```
Special Funct.\...\Cut-off Flow
```

- Enter the cut-off flow.
- Press ENTER.

All negative values of the flow velocity greater than this limit will be set to zero.

If `Cut-off Flow\absolut` and `user` are selected, only one value have to be entered:

```
Special Funct.\...\Cut-off Flow
```

- Enter the cut-off flow.
- Press ENTER.

All absolute values of the flow velocity smaller than this limit are set to zero.

17.6 Profile correction

The following settings can be made for the calculation of the fluid mechanics calibration factor k_{Re} :

- `off`: profile correction 1.0
- `on`: profile correction 2.0 at ideal inflow conditions (default)
- `With disturbance`: profile correction 2.0 at non ideal inflow conditions

The following steps are necessary to set the profile correction:

- Selection of the profile correction setting for all measuring channels in the program branch `Special Funct.`
- Input of the disturbance distance in the program branch `Parameter` if `With disturbance` has been selected

If `With disturbance` has been selected, the transducers have to be mounted in reflection arrangement, X arrangement or displaced X arrangement to compensate transverse flow effects. When mounting in X arrangement, it is essential to set the same parameters for both measuring channels and to activate for them a calculation channel with average generation.

Selection of the setting

```
Special Funct.\...\Measuring\ProfileCorr 2.0
```

- Select the menu item `Special Funct.` in the program branch `Measuring`.
- Press ENTER until the menu item `ProfileCorr 2.0` is displayed.
- Select a list item (default: `on`).
- Press ENTER.

Input of the disturbance distance

If `With disturbance` is selected in the menu item `Special Funct.\SYSTEM settings\Measuring\ProfileCorr 2.0`, the disturbance distance has to be entered in the program branch `Parameter`.

```
Disturb.distance
      2.3      m
```

- Enter the disturbance distance.
- Press ENTER.

Measurement

When starting the measurement, it is checked whether the measurement arrangement is appropriate.

17.7 Uncorrected flow velocity

For special applications, the uncorrected flow velocity might be of interest.

The profile correction for the flow velocity is activated in `Special Funct.\SYSTEM settings\Measuring\Flow Velocity`.

```
Special Funct.\SYSTEM settings\Measuring\Flow Velocity
```

- Select `normal` to display and output the flow velocity with profile correction.
- Select `uncorr.` to display and output the flow velocity without profile correction.
- Press ENTER.

If `uncorr.` is selected, each time the program branch `Measuring` is selected it will be requested whether the profile correction is to be used or not.

```
A:PROFILE CORR.
>NO<          yes
```

If `no` is selected, the profile correction will be switched off. All physical quantities will be calculated with the uncorrected flow velocity.

During the measurement, the designation of the physical quantity is displayed in capital letters to indicate that the value is uncorrected.

```
A:FLOW VELOCITY
      2.60      m/s
```

- Press ENTER.

```
A:PROFILE CORR.  
>no<          YES
```

If `yes` is selected, the uncorrected flow velocity will only be used if the flow velocity is selected as physical quantity in the program branch `Output Options`.

All other physical quantities (volumetric flow rate, mass flow rate, etc.) will be determined with the corrected flow velocity.

During the measurement, the designation of the physical quantity "flow velocity" is displayed in capital letters to indicate that the value is uncorrected.

- Press ENTER.

In both cases, the corrected flow velocity can also be displayed.

```
A:Flow Velocity  
*U      24      m/s
```

Press key `3` to scroll until the flow velocity is displayed. The uncorrected flow velocity is marked with an "U".

Uncorrected flow velocities transmitted to a PC are marked with `uncorr.`

17.8 FastFood mode

The FastFood mode allows to measure high dynamic flows. A continuous adaptation to changing measuring conditions is only partially realized in the FastFood mode.

The sound speed of the fluid is not updated. The last measured value of the sound speed before toggling to the FastFood mode is used.

It is not possible to change the measuring channel. The measurement takes place on one channel only. As long as the FastFood mode is activated, no measurement is carried out on the other channels.

The outputs of the FastFood mode activated channel can still be used. They are actualized every 100 ms independently from the storage rate.

Outputs for further channels (multi-channel measurement) transmit an error value.

The measured values are stored with the storage rate of the FastFood mode, see section 17.8.2.

The FastFood mode has to be enabled and activated.

17.8.1 Enabling/disabling the FastFood mode

- Enter the HotCode **007022** immediately after the transmitter has been switched on.

```
Enable FastFood
```

- Select `yes` to enable the FastFood mode, `no` to disable it.
- Press ENTER.

```
Enable FastFood\FF-check (0=OFF)
```

If the FastFood mode is enabled, a time `t` has to be entered. When the FastFood mode is started, the signal amplification settings will always be checked after the expiration of time `t`.

Enter zero if no check is to be carried out.

17.8.2 Storage rate of the FastFood mode

```
Output Options\...\Storing\Storage Rate
```

If the FastFood mode is enabled and when activating the data logger it is necessary to enter a storage rate in ms in the program branch `Output Options`.

17.8.3 Activation/deactivation of the FastFood mode

If the FastFood mode is enabled and a measurement is started, the normal measuring mode will still be running (i.e. multi-channel measurement with permanent adaptation to the measuring conditions). If the data logger is activated, the measured values will not be stored.

- Press key **[0]** to activate/deactivate the FastFood mode for the measuring channel currently displayed.
- Press key **[9]** to scroll through the upper line until the activated measuring mode `A:Mode=FastFood` or `A:Mode=TransTime` is displayed.

A:Mode=FastFood
54.5 m3/h

If the data logger is activated, a new data set will be created and the storing of measured values will be started. If the FastFood mode is deactivated or the measurement is interrupted, the storing will be stopped.

Notice!
The values of the current series of measured values will be deleted if the FastFood mode is deactivated and activated again without interrupting the measurement.
The values of the current series of measured values will be kept if the measurement is interrupted before the FastFood mode is activated again. A new series of measured values is created when the next measurement is started.

17.9 Calculation channels

Notice!
Calculation channels are only available if the transmitter has more than one measuring channel.

In addition to the ultrasonic measuring channels, the transmitter has 2 virtual calculation channels Y and Z. The measured values of the measuring channels A and B can be calculated via the calculation channels.

The result of the calculation is the measured value of the selected calculation channel. This measured value is equivalent to the measured values of a measuring channel. All functions which are possible with the measured values of a measuring channel (totalizing, online transmission of data, storing, output, etc.) can also be done with the values of a calculation channel.

17.9.1 Characteristics of the calculation channels

The measuring channels to be used for calculation and the calculation function have to be entered in the program branch `Parameter`.

It is possible to define 2 cut-off flows for each calculation channel. The cut-off flow is not based on the flow velocity as is the case with the measuring channels. Instead, it is defined in the unit of measurement of the physical quantity selected for the calculation channel. During the measurement, the calculation values are compared with the cut-off values and set to zero, if necessary.

A calculation channel provides valid measured values if at least one measuring channel provides valid measured values.

17.9.2 Parameterization of a calculation channel

```
Parameter\for Channel Y
```

- Select a calculation channel (Y or Z) in the program branch `Parameter`.
- Press ENTER.

```
Parameter\for Channel Y\Calculation: Y= A - B
```

The current calculation function is displayed.

- Press ENTER to edit the function.

```
>CH1< funct ch2↓
A      -      B
```

Three scroll lists are displayed in the upper line:

- selection of the first measuring channel (`ch1`)
- selection of the calculation function (`funct`)
- selection of the second measuring channel (`ch2`)

- Select a scroll list with key `< 4` or `> 6`.

The list items are displayed in the lower line.

- Press key `^ 8` and `^ 2` to scroll through the scroll list. All measuring channels and their absolute values can be assigned to an input channel.

The following calculation functions are available:

-	$Y = ch1 - ch2$
+	$Y = ch1 + ch2$
(+)/2	$Y = (ch1 + ch2) / 2$
(+)/n	$Y = (ch1 + ch2) / n$
-	$Y = ch1 - ch2 $

- Press ENTER.

After the parameterization of the calculation channel, the message `Y: is valid if A: and B: valid` will be displayed if the calculation function `(+)/2` is selected. The measured values of the calculation channel (here: `Y`) will be valid if the measured values of both measuring channels (here: `A` and `B`) are valid. If only one measuring channel provides valid measured values, the measured values of the calculation channel will be invalid.

After the parameterization of the calculation channel, the message `Y: is valid if A: or B: valid` will be displayed if the calculation function `(+)/n` is selected. The measured values of the calculation channel (here: `Y`) will be valid if the measured values of at least one measuring channel (here `A` or `B`) are valid. If only one measuring channel provides valid measured values, these measured values will be used for the calculation channel.

17.9.3 Output options for a calculation channel

```
Output Options\for Channel Y
```

- Select a calculation channel in the program branch `Output Options`.
- Press ENTER.

```
Output Options\for Channel Y\Physic. Quant.
```

- Select the physical quantity to be calculated.
- Press ENTER.

Make sure that the physical quantity selected for the calculation channel can be calculated from the physical quantities of the selected measuring channels, Tab. 17.2.

Tab. 17.2: Physical quantity of the calculation channel

physical quantity of the calculation channel	possible physical quantity of the first measuring channel				possible physical quantity of the second measuring channel			
	flow velocity	volume flow rate	mass flow rate	thermal energy rate	flow velocity	volume flow rate	mass flow rate	thermal energy rate
flow velocity	X	X	X	X	X	X	X	X
volumetric flow rate		X	X	X		X	X	X
mass flow rate		X	X	X		X	X	X
heat flow				X				X

Example

The difference of the volume flow rates of the channels A and B is to be calculated. The physical quantity of the measuring channel A and B can be the volumetric flow rate or the mass flow, but not the flow velocity. The physical quantities of the 2 measuring channels do not need to be identical (channel A = mass flow, channel B = volumetric flow rate).

```
Output Options\for Channel Y:\...\Mass in
```

- Select the unit of measurement.
- Press ENTER.

It is possible to define 2 cut-off flows for each calculation channel. They are defined in the unit of measurement of the physical quantity selected for the calculation channel.

```
Output Options\for Channel Y\...\+Cut-off Flow
```

All positive calculated values less than the limit are set to zero.

```
Output Options\for Channel Y\...\-Cut-off Flow
```

All negative calculated values that are greater than the limit are set to zero.

```
Output Options\for Channel Y\...\Damping
```

- Enter the damping factor. If the damping factor for the measuring channels A or B has already been entered in the program branch, see section 9.2.2, enter zero.
- Press ENTER.

```
Output Options\for Channel Y\...\Store Meas.Data
```

- Select *yes* to activate the data logger and *no* to deactivate it.
- Press ENTER.

17.9.4 Measurement with calculation channels

```
Measuring\CHANN: A B Y Z
```

- Select the program branch *Measuring*.
- Press ENTER.
- Activate the necessary channels. The calculation channels are activated or deactivated the same way as measuring channels.
- Press ENTER.

If a measuring channel that is needed for an activated calculation channel has not been activated, a warning will be displayed.

```
Measuring\...\WARNING! CHANNEL B:INACTIV!
```

- Press ENTER.

Position the transducers for all activated measuring channels. The measurement will be started automatically.

If a calculation channel is activated, the HumanMux mode will be selected at the beginning of the measurement and the values of the calculation channel will be displayed.

If the AutoMux mode is selected, the measured values of the measuring channels will be displayed alternately (but not the measured values of the calculation channels).

```
Y: FLOW VELOCITY
  53.41      m/s
```

- Press key to display the calculation function.
- Press key to display the measured values of the different channels.

17.10 Diagnosis with the help of the snap function

By means of the snap function it is possible to store measuring parameters which are useful for the evaluation of measuring results or diagnosis purposes.

```
Special Funct.\SYSTEM settings\Signal snap
```

- Select the menu item `Special Funct.\SYSTEM settings\Signal snap`.
- Press ENTER.

Snap memory settings

```
Special Funct.\SYSTEM settings\Signal snap\DSP-SignalSnap
```

- Select `on` to activate the snap function and `off` to deactivate it.
- Press ENTER.

```
Special Funct.\...\DSP-SignalSnap\Install Snap
```

- Select `Install Snap`.
- Press ENTER.

```
Special Funct.\...\DSP-SignalSnap\Install Snap\Snap-Memory
```

- Enter the number of the snap memory storage space.
- Press ENTER.

```
Special Funct.\...\DSP-SignalSnap\AutoSnap
```

- Activate or deactivate the auto-snap function.
- Press ENTER.

```
Special Funct.\...\DSP-SignalSnap\Snap ringbuffer
```

- Activate or deactivate the snap ringbuffer.
- Press ENTER.

Delete snaps

```
Special Funct.\SYSTEM settings\Signal snap\DSP-SignalSnap\  
Clear Snaps
```

- Select Clear Snaps.
- Press ENTER.

Read snaps

```
Special Funct.\SYSTEM settings\Signal snap\DSP-SignalSnap\  
Snaps ->Rs232
```

- Select Snaps ->Rs232.
- Press ENTER.

Activation of the snap function

In order to activate the snap function, press key during the measurement.

17.11 Modification of the limit for the inner pipe diameter

It is possible to modify the lower limit of the inner pipe diameter for a given transducer type.

- Enter the HotCode **071001** immediately after the transmitter has been switched on.

DNmin Q-Sensor
15 mm

- Enter the lower limit of the inner pipe diameter of the displayed transducer type.
- Press ENTER to select the next transducer type.

Notice!

If a transducer is used below its recommended inner pipe diameter, a measurement might be impossible.

17.12 Transducer temperature

It is possible to output the transducer temperature.

- Enter the HotCode **007043** immediately after the transmitter has been switched on.

```
Show T-transd.?
no                >YES<
```

- Select *yes* to display the transducer temperature during the measurement.
- Press ENTER.

```
Store T-transd.?
no                >YES<
```

- Select *yes* to store the transducer temperature.
- Press ENTER.

17.13 Activation of a binary output as alarm output

Notice!
The menu item Alarm Output will only be displayed in the program branch Output Options if a binary output has been installed, see section 13.2.

```
Output Options\for Channel A
```

- Select the channel for which the output is to be activated in the program branch **Output Options**.
- Press ENTER.
- Press ENTER until **Alarm Output** is displayed. Select *yes* to activate the alarm output.
- Press ENTER.

A max. of 3 independently operating alarm outputs R1, R2, R3 can be configured per channel. The alarm outputs can be used to output information on the current measurement or to start and stop pumps, motors, etc.

17.13.1 Alarm properties

The switching condition, the holding behavior and the switching function of an alarm output can be defined.

```
R1=FUNC<typ mode
Function:    MAX
```

The following 3 scroll lists are displayed:

- `func`: switching condition
- `typ`: holding behavior
- `mode`: switching function

Press key `4` and `6` to select a scroll list in the upper line. Press key `8` and `2` to select a list item in the lower line.

- Press ENTER to store the settings.

Tab. 17.3: Alarm properties

alarm property	setting	description
func (switching condition)	MAX	The alarm will switch if the measured value exceeds the upper limit.
	MIN	The alarm will switch if the measured value falls below the lower limit.
	+→- -→+	The alarm will switch if the flow direction changes (sign change of measured value).
	QUANT.	The alarm will switch if totalizing is activated and the totalizer reaches the limit.
	ERROR	The alarm will switch if a measurement is not possible.
	OFF	The alarm is switched off.
typ (holding behavior)	NON-HOLD	If the switching condition is no longer true, the alarm will return to the idle state after approx. 1 s.
	HOLD	The alarm remains activated even if the switching condition is no longer true.
mode (switching function)	NO Cont.	The alarm is energized if the switching condition is true and de-energized if idle.
	NC Cont.	The alarm is de-energized if the switching condition is true and energized if idle.

Notice!

If no measurement is made, all alarms will be de-energized, independently of the programmed switching function.

17.13.2 Setting the limits

If the switching condition **MIN** or **MAX** is selected in the scroll list **func**, the limit of the output has to be defined:

```
R1 Input\Mass Flow
```

- Select the physical quantity to be used for the comparison in the scroll list **Input**. The following list items are available for the alarm output **R1**:
 - selected physical quantity
 - signal amplitude
 - sound speed of the fluid
- Press **ENTER**.

For the alarm outputs **R2** and **R3** the current physical quantity is set automatically.

If the switching condition **MAX** is selected in the scroll list **func**:

```
R1 Input\Function: MAX\High Limit
```

- Enter the upper limit.
- Press **ENTER**.

The alarm will switch if the measured value exceeds the limit.

If the switching condition **MIN** is selected in the scroll list **func**:

```
R1 Input\Function: MIN\Low Limit
```

- Enter the lower limit.
- Press **ENTER**.

The alarm will switch if the measured value falls below the limit.

Example

High Limit: -10 kg/h
 mass flow rate = -9.9 kg/h
 the limit is exceeded, the alarm switches
 mass flow rate = -11 kg/h
 the limit is not exceeded, the alarm does not switch

Example

Low Limit: -10 kg/h
 mass flow rate = -11 kg/h
 the measured value is below the limit, the alarm switches
 mass flow rate = -9.9 kg/h
 the measured value is not below the limit, the alarm does not switch

If the switching condition `QUANT.` is selected in the scroll list `func`, the limit of the output has to be defined:

```
R1 Input\Function: QUANT.\Quantity Limit
```

- Enter the limit of the totalizer.
- Press ENTER.

The alarm will switch when the measured value reaches the limit.

A positive limit will be compared to the totalizer value for the positive flow direction.

A negative limit will be compared to the totalizer value for the negative flow direction.

The comparison will also take place if the totalizer of the other flow direction is displayed.

Notice!

The unit of measurement of the limit is set according to the unit of measurement of the selected physical quantity.

If the unit of measurement of the physical quantity is changed, the limit has to be converted and entered again.

Example

physical quantity: mass flow rate in kg/h
 Quantity Limit: 1 kg

Example

physical quantity: mass flow rate in kg/h

Low Limit: 60 kg/h

The unit of measurement of the physical quantity is changed to kg/min. The new limit to be entered is 1 kg/min.

17.13.3 Defining the hysteresis

A hysteresis can be defined for the alarm output R1. This prevents a constant triggering of the alarm when measured values fluctuate marginally around the limit.

The hysteresis is a symmetrical range around the limit. The alarm will be activated if the measured values exceed the upper limit and deactivated if the measured values fall below the lower limit.

Example

High Limit: 30 kg/h

Hysteresis: 1 kg/h

The alarm is activated for measured values > 30.5 kg/h and deactivated for measured values < 29.5 kg/h.

If the switching condition `MAX` or `MIN` is selected in the scroll list `func`:

```
R1 Input\...\Hysteresis
```

- Enter a value for the hysteresis or enter zero to work without hysteresis.
- Press ENTER.

17.14 Behavior of the alarm outputs

17.14.1 Apparent switching delay

The measured values and totalizer values will be displayed rounded to 2 decimal places. The limits, however, will be compared to the non-rounded measured values. This might cause an apparent switching delay when the measured value changes marginally (less than 2 decimal places). In this case the switching accuracy of the output is higher than the accuracy of the display.

17.14.2 Reset and initialization of the alarms

After an initialization of the transmitter, all alarm outputs will be configured as follows:

Tab. 17.4: Alarm state after an initialization

func	OFF
typ	NON-HOLD
mode	NO Cont.
Limit	0.00

Press 3 times key C during the measurement to set all alarm outputs to idle state. Alarm outputs whose switching condition is still met will be activated again after 1 s. This function is used to reset alarm outputs of the type `HOLD` if the switching condition is no longer met.

By pressing key BRK, the measurement is stopped and the main menu is selected. All alarm outputs will be de-energized, independently of the programmed idle state.

17.14.3 Alarm outputs during transducer positioning

At the beginning of the transducer positioning (bar graph display), all alarm outputs switch back to the programmed idle state.

If the bar graph is selected during the measurement, all alarm outputs will switch back to the programmed idle state.

An alarm output of the type `HOLD` that has been activated during the previous measurement will remain in idle state after the transducer positioning if its switching condition is no longer met.

The switching of the alarms into idle state will not be displayed.

17.14.4 Alarm outputs during measurement

An alarm output with switching condition `MAX` or `MIN` will be updated max. once per second to avoid humming (i.e. fluctuation of the measured values around the value of the switching condition).

An alarm output of the type `NON-HOLD` will be activated if the switching condition is met. It will be deactivated if the switching condition is no longer met. The alarm remains activated for at least 1 s even if the switching condition is met for a shorter period of time.

Alarm outputs with the switching condition `QUANT.` will be activated if the limit is reached.

Alarm outputs with the switching condition `ERROR` will only be activated after several unsuccessful measuring attempts. Therefore, typical short-term disturbances of the measurement (e.g., switching on of a pump) will not activate the alarm.

Alarm outputs with the switching condition `+→- -→+` and the type `NON-HOLD` will be activated with each change of the flow direction for approx. 1 s, see Fig. 17.1.

Alarm outputs with the switching condition `+→- -→+` and of the type `HOLD` will be activated after the first change of the flow direction. They can be switched back by pressing key C 3 times, see Fig. 17.1.

Fig. 17.1: Behavior of a relay when the flow direction changes

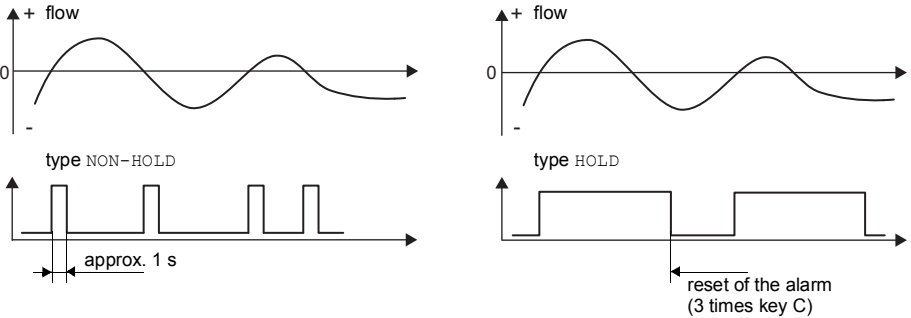

When adjusting to changed measurement conditions e.g. a substantial increase of the fluid temperature, the alarm will not be switched. Alarm outputs with the switching condition OFF will be set automatically to the switching function NO Cont.

Notice!
There is neither a visual nor an acoustic indication of the alarm output switching.

The alarm state can be displayed after the configuration of the alarm outputs and during the measurement. This function is activated in `Special Funct.\SYSTEM settings\Dialogs/Menus`. The activation of this function is recommended when alarm outputs have to be reconfigured frequently.

```
Special Funct.\SYSTEM settings\Dialogs/Menus\SHOW RELAIS STAT
```

- Select `SHOW RELAIS STAT`.
- Select `on` to activate the alarm state indication.
- Press `ENTER`.

If the alarm state indication is activated, the alarm output state is displayed after configuring the alarm outputs.

The alarm state indication is structured as follows:

$R_x = \square \square \square$, with x being the number of the alarm output and \square a pictogram according to Tab. 17.5.

The configuration of the alarm outputs can be repeated by pressing key C. When the configuration of the alarm outputs is finished, press `ENTER`. The main menu will be displayed.

If the alarm output indication is activated, the alarm state can be displayed during the measurement. Press key 9 to scroll through the upper line or key 3 in the lower line until the alarm state is displayed.

Tab. 17.5: Pictograms for the alarm state indication

	no.		func (switching condition)	typ (holding behavior)	mode (switching function)	current state
R		=				
			OFF	NON-HOLD	NO Cont.	closed
	1		MAX	HOLD	NC Cont.	open
	2		MIN			
	3		+→- →+			
			QUANT.			
			ERROR			

Example

R1 =

17.14.5 Deactivation of an alarm output

If the programmed outputs are no longer required, they can be deactivated. The configuration of a deactivated output is stored and will be available if the output is activated again.

Output Options\...\Alarm Output

- Select **no** in the menu item **Output Options\Alarm Output** to deactivate an output.
- Press **ENTER**.

18 SuperUser mode

The SuperUser mode offers the possibility of an advanced diagnostic of signals and measured values as well as the definition of additional parameters adapted to the measuring point, in order to achieve better measured values or for experimental work. Special features of the SuperUser mode are:

- Default settings will not be used.
- There are no plausibility tests during the parameter entry.
- It is not checked whether the entered parameters are within the limits given by physical laws and technical data.
- The cut-off flow is not activated.
- A number of sound paths has to be entered.

Some menu items that are not visible in the normal mode are displayed.

Notice!

The SuperUser mode is intended for experienced users with advanced application knowledge. The parameters can affect the normal measuring mode and lead to wrong measured values or to a measurement failure when a new measuring point is set up.

18.1 Activation/deactivation

- Enter the HotCode **071049** immediately after the transmitter has been switched on.

```
SUPERUSER MODE\IS ACTIVE NOW
```

It is displayed that the SuperUser mode is activated.

- Press ENTER. The main menu will be displayed.

The SuperUser mode is deactivated by switching off the transmitter.

Notice!

Some of the defined parameters are still activated after the deactivation of the SuperUser mode.

18.2 Transducer parameters

In the SuperUser mode, the menu item `Transducer Type` will be displayed in the program branch `Parameter` at the end of the input even if the transducers are detected by the transmitter.

```
Parameter\...\Transducer Type\Q2E-314
```

- Press ENTER.

or:

```
Parameter\...\Transducer Type\Special Version
```

- Select `Special Version` to enter the transducer parameters.
- Press ENTER.

```
Parameter\...\Transducer Type\Special Version\Transd. Data 1
```

- If `Special Version` is selected, the transducer parameters have to be entered. The transducer parameters have to be provided by FLEXIM.
- Press ENTER after each input.

18.3 Defining flow parameters

In the SuperUser mode, it is possible to define some flow parameters (profile bounds, correction of the flow velocity) for the specific application or measuring point.

```
Special Funct.\SYSTEM settings\Measuring\Calibration
```

- Select the menu item `Special Funct.\SYSTEM settings\Measuring\Calibration`.
- Press ENTER.

```
Special Funct.\SYSTEM settings\Measuring\Calibration\for Channel A
```

- Select the measuring channel for which the flow parameters are to be defined (here: Channel A).
- Press ENTER.

18.3.1 Profile bounds

```
Special Funct.\...\Calibration\...\Profile bounds
```

- Select `user` to define the profile bounds. If `factory` is selected, the default profile bounds will be used and the menu item `Calibration` will be displayed.
- Press ENTER.

```
Special Funct.\...\Calibration\...\Laminar flow
```

- Enter the max. Reynolds number at which the flow is laminar. The entered number will be rounded to hundreds. Enter zero to use the default value of 1000.
- Press ENTER.

```
Special Funct.\...\Calibration\...\Turbulent flow
```

- Enter the min. Reynolds number at which the flow is turbulent. The entered number will be rounded to hundreds. Enter zero to use the default value of 3000.
- Press ENTER.

```
Special Funct.\...\Calibration\...\Calibration
```

A request is displayed if an additional correction of the flow velocity is to be defined.

- Select `on` to define the correction data, `off` to work without correction of the flow velocity and return to the menu item `SYSTEM settings`.

Example

profile bound for laminar flow: 1500

profile bound for turbulent flow: 2500

At Reynolds numbers < 1500, the flow is regarded as laminar for the calculation of the physical quantity. At Reynolds numbers > 2500, the flow is regarded as turbulent. The range 1500...2500 is the transition range between laminar and turbulent flow.

Notice!

The defined profile bounds are still activated after the deactivation of the SuperUser mode.

18.3.2 Correction of the flow velocity

After the profile bounds have been defined, it is possible to define a correction of the flow velocity:

$$V_{\text{cor}} = m \cdot v + n$$

where

- v – measured flow velocity
- m – slope, range: -2.0...+2.0
- n – offset, range: -12.7...+12.7 cm/s
- V_{cor} – corrected flow velocity

All quantities derived from the flow velocity will be calculated with the corrected flow velocity. The correction data will be transmitted to the PC or printer during the online or offline transmission.

Notice!

It will not be displayed that the correction of the flow velocity is active during the measurement.

```
Special Funct.\...\Calibration\...\Calibration
```

- Select **on** to define the correction data, **off** to work without correction of the flow velocity and return to the menu item **SYSTEM** settings.

```
Special Funct.\...\Calibration\...\Calibration\Slope
```

- If **on** is selected, enter the slope. The input of zero deactivates the correction.
- Press **ENTER**.

```
Special Funct.\...\Calibration\...\Calibration\Offset
```

- Enter the offset. Enter zero to work without offset.
- Press **ENTER**.

Example

Slope: 1.1

Offset: -10.0 cm/s = -0.1 m/s

If a flow velocity $v = 5$ m/s is measured, before the calculation of the derived quantities, it will be corrected as follows:

$$v_{\text{cor}} = 1.1 \cdot 5 \text{ m/s} - 0.1 \text{ m/s} = 5.4 \text{ m/s}$$

Example

Slope: -1.0

Offset: 0.0

Only the sign of the measured values changes.

Notice!

The correction data will only be stored when a measurement is started. If the transmitter is switched off without starting a measurement, the entered correction data will be lost.

Notice!

The correction of the flow velocity is still activated after the deactivation of the SuperUser mode.

18.4 Limit of the signal amplification

In order to prevent disturbing and/or pipe wall signals (e.g., if the pipe has run empty) from being interpreted as useful signals, it is possible to define a max. signal amplification. If the signal amplification is greater than the max. signal amplification,

- the flow velocity will be marked as invalid. The physical quantity cannot be determined.
- a hash symbol (#) will be displayed after the unit of measurement (in case of a normal error, (?) is displayed).

```
Special Funct.\SYSTEM settings\Measuring\Miscellaneous\
Gain threshold
```

- Select the menu item `Special Funct.\SYSTEM settings\Measuring\Miscellaneous`.
- Press ENTER until the menu item `Gain threshold` is displayed.

```
Special Funct.\SYSTEM settings\Measuring\Miscellaneous\  
Gain threshold\Fail if > 90 dB
```

- Enter for each measuring channel the max. signal amplification.
- Enter zero to measure without a limit of the signal amplification.
- Press ENTER.

The current value of the amplification (**GAIN**) can be displayed in the upper line in the program branch *Measuring*. If the current value of the amplification is higher than the max. amplification, the current value is displayed with →FAIL!.

Notice!

The limit of the signal amplification is still activated after the deactivation of the SuperUser mode.

18.5 Upper limit of the sound speed

When the plausibility of the signal is evaluated, it will be checked whether the sound speed is within a defined range. The used upper limit of the fluid sound speed is the greatest of the following values:

- fixed upper value, default: 1848 m/s
- value of the sound speed curve of the fluid at the operating point plus offset, default offset: 300 m/s

In the SuperUser mode, the values can be defined for fluids that are not contained in the data set of the transmitter.

```
Special Funct.\SYSTEM settings\Measuring\Miscellaneous\Bad  
soundspeed
```

- Select the menu item *Special Funct.\SYSTEM settings\Measuring\Miscellaneous*.
- Press ENTER until the menu item *Bad soundspeed* is displayed.

```
Special Funct.\SYSTEM settings\Measuring\Miscellaneous\Bad  
soundspeed\thresh.
```

- Enter for each measuring channel the fixed upper limit of the sound speed.
- Enter zero to use the default value of 1848 m/s.
- Press ENTER.

```
Special Funct.\SYSTEM settings\Measuring\Miscellaneous\Bad
soundspeed\offset
```

- Enter for each measuring channel the offset.
- Enter zero to use the default value of 300 m/s.
- Press ENTER.

Example

fixed upper value of the sound speed (*thresh.*): 2007 m/s

offset: 600 m/s

value of the sound speed curve at the operating point: 1546 m/s

As 1546 m/s + 600 m/s = 2146 m/s is greater than the fixed upper value 2007, this value will be used as the upper limit of the sound speed when the plausibility of the signal is evaluated.

It is possible to display the valid range for the sound speed (SS) in the lower line within the program branch *Measuring* during the measurement. The second value (here: 2146 m/s) corresponds to the upper limit at the operating point.

Fig. 18.1: Display of the valid sound speed range

GAIN=91dB
SS=1038/2146 m/s

Notice!

The defined upper limit of the sound speed remains activated after the deactivation of the SuperUser mode.

Total digits = Fixed to x digit

The number of decimal points is constant. The max value of the totalizer is reduced with the number of decimal places.

decimal places	max. value	max. display
0	$< 10^{10}$	±9999999999
1	$< 10^8$	±99999999.9
2	$< 10^7$	±9999999.99
3	$< 10^6$	±999999.999
4	$< 10^5$	±99999.9999

Notice!

The number of decimal places and the max. value defined here only affect the display of the totalizers.

18.8 Temperature-based thermal energy rate cut-off

With the temperature-based thermal energy rate cut-off, all measured temperature differences between the supply and return line that are lower than a defined value are set to zero. The thermal energy rate is also set to zero. The value of the thermal energy totalizer remains unchanged.

```
Special Funct.\SYSTEM settings\Measuring\Miscellaneous\Thermal
low cut
```

- Select the menu item `Special Funct.\SYSTEM settings\Measuring\Miscellaneous`.
- Press ENTER until the menu item `Thermal low cut` is displayed.
- Select `on` to activate the temperature-based thermal energy rate cut-off, `off` to deactivate it.
- Press ENTER.

```
Special Funct.\SYSTEM settings\Measuring\Miscellaneous\Thermal
low cut\Thermal flow ->0
```

- If `on` is selected, enter the limit of the temperature difference. All temperature differences between the supply and return line that are lower than this value will be set to zero. Enter zero to work without the temperature-based thermal energy rate cut-off.
- Press ENTER.

18.9 Manual reset of the totalizers

If the manual reset of the totalizers is activated, the totalizers can be reset to zero during the measurement by pressing key C 3 times.

```
Special Funct.\SYSTEM settings\Measuring\Miscellaneous\3xC  
clear totals
```

- Select the menu item `Special Funct.\SYSTEM settings\Measuring\Miscellaneous`.
- Press ENTER until the menu item `3xC clear totals` is displayed.
- Select `on` to activate the manual reset of the totalizers, `off` to deactivate it.
- Press ENTER.

Notice!

The manual reset of the totalizers is still activated after the deactivation of the SuperUser mode.

18.10 Display of the totalizer sum

The totalizer sum of both flow directions can be displayed in the upper line during the measurement.

```
Special Funct.\SYSTEM settings\Measuring\Miscellaneous\Show  $\Sigma Q$ 
```

- Select the menu item `Special Funct.\SYSTEM settings\Measuring\Miscellaneous`.
- Press ENTER until the menu item `Show ΣQ` is displayed.
- Select `on` to activate the display of the totalizer sum, `off` to deactivate it.
- Press ENTER.

If the display of the totalizer sum is activated, the sum ΣQ of the totalizers can be displayed in the upper line during the measurement.

Fig. 18.2: Display of the totalizer sum

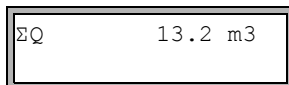

The screenshot shows a rectangular display area with a double border. On the left side, the symbol ΣQ is displayed. On the right side, the value `13.2 m3` is displayed.

18.11 Display of the last valid measured value

If the signal is not sufficient for a measurement, UNDEF is normally displayed. Instead of UNDEF, it is also possible to display the last valid measured value.

```
Special Funct.\SYSTEM settings\Measuring\Miscellaneous\Keep
display val
```

- Select the menu item Special Funct.\SYSTEM settings\Measuring\Miscellaneous.
- Press ENTER until the menu item Keep display val is displayed.
- Select on to activate the display of the last valid measured value, off to deactivate it.
- Press ENTER.

18.12 Displays during the measurement

Besides the normal information, see section 9.4, the following parameters can be displayed during the measurement in the SuperUser mode:

display	explanation
t	transit time of the measuring signal in the fluid
c	sound speed
REYNOLD	Reynolds number
VARI A	standard deviation of the signal amplitude
VARI T	standard deviation of the transit time of the measuring signal
dt-norm	transit time difference standardized to the transducer frequency
	fluid density

19 Settings

19.1 Dialogs and menus

```
Special Funct.\SYSTEM settings\Dialogs/Menu
```

- Select the menu item `Special Funct.\SYSTEM settings\Dialogs/Menu`.
- Press ENTER.

Notice!

The settings will be stored at the end of the dialog. If the menu item is quit by pressing key BRK, the changes will not be stored.

19.1.1 Pipe circumference

```
Special Funct.\...\Dialogs/Menu\Pipe Circumfer.
```

- Select `on` if the pipe circumference is to be entered instead of the pipe diameter in the program branch `Parameter`.
- Press ENTER.

```
Special Funct.\...\Dialogs/Menu\Pipe Circumfer.\Outer Diameter
```

If `on` is selected for `Pipe Circumfer.`, the outer pipe diameter will still be requested in the program branch `Parameter`.

- In order to select the menu item `Pipe Circumfer.`, enter zero.
- Press ENTER.

The value displayed in `Pipe Circumfer.` is calculated on the basis of the last displayed value of the outer pipe diameter.

Example: $100 \text{ mm} \cdot \pi = 314.2 \text{ mm}$

- Enter the pipe circumference. The limits for the pipe circumference are calculated on the basis of the limits for the outer pipe diameter.
- Press ENTER.

During the next scroll through the program branch `Parameter`, the outer pipe diameter that corresponds to the entered pipe circumference will be displayed.

Example: $180 \text{ mm} : \pi = 57.3 \text{ mm}$

Notice!

The edition of the pipe circumference is only temporarily. When the transmitter switches back to the display of the pipe circumference (internal recalculation), slight rounding errors may occur.

Example

entered pipe circumference: 100 mm
displayed outer pipe diameter: 31.8 mm

When the transmitter switches back to the display of the pipe circumference, 99.9 mm will be displayed.

19.1.2 Fluid pressure

The dependence of the parameters of a fluid on the pressure can be taken into account.

```
Special Funct.\...\Dialogs/Menus/Fluid pressure
```

- Select **on** to enter the fluid pressure in the program branch **Parameter**. Select **off** if 1 bar is to be used for all calculations.
- Press **ENTER**.

Notice!

For documentation purposes, it is useful to enter the fluid pressure, even if the transmitter contains no pressure-dependent characteristic curves.

19.1.3 Measuring point number

```
Special Funct.\...\Dialogs/Menus/Meas.Point No.
```

- Select **(1234)** if the measuring point is to be identified only by numbers, point and hyphen.
- Select **(↑↓←→)** if the measuring point is to be designated with ASCII characters.
- Press **ENTER**.

19.1.4 Transducer distance

```
Special Funct.\...\Dialogs/Menus\Transd. Distance
```

recommended setting: `user`

- `user` will be selected if the measuring point is always the same
- `auto` can be selected if the measuring point often changes

In the program branch `Measuring`, the recommended transducer distance will be displayed in parentheses, followed by the entered transducer distance if the recommended and the entered transducer distance are not identical.

```
Transd. Distance
(50.8) 50.0 mm
```

During the transducer positioning, in the program branch `Measuring`:

- only the entered transducer distance will be displayed if `Transd. Distance = user` is selected and the recommended and the entered transducer distances are identical
- only the recommended transducer distance will be displayed if `Transd. Distance = auto` is selected

19.1.5 Steam in inlet

```
Special Funct.\...\Dialogs/Menus\Steam in inlet
```

- Select `on` in case the fluid in the supply line is vaporous during the thermal energy rate measurement, see section 21.6. In this case, the supply pressure will have to be entered in the program branch `Parameter`.
- Press ENTER.

19.1.6 Temperature correction

```
Special Funct.\...\Dialogs/Menus\Tx Corr.Offset
```

- Select `on` to enable the input of a temperature correction for each temperature input.
- Press ENTER.

19.1.7 Error delay

The error delay is the time interval after which the entered value for the error value is transmitted to the output in case no valid measured values are available.

```
Special Funct.\...\Dialogs/Menu\Error-val. delay
```

- Select `damping` if the damping factor is to be used as the error delay. Select `edit` to activate the menu item `Error-val. delay` in the program branch `Output Options`. From now on, the error delay can be entered in the program branch `Output Options`.
- Press ENTER.

19.1.8 Alarm state indication

```
Special Funct.\...\Dialogs/Menu\SHOW RELAIS STAT
```

- Select `on` to display the alarm state during the measurement.
- Press ENTER.

19.1.9 Units of measurement

It is possible to set the units of measurement for the length, temperature, pressure, density and kinematic viscosity and sound speed.

- Select a unit of measurement for all quantities.
- Press ENTER after each selection.

19.1.10 Settings relating the fluid pressure

It is possible to set whether the absolute or the relative pressure is to be used:

```
Special Funct.\...\Dialogs/Menu\Pressure absolut
```

- Select `on` or `off`.
- Press ENTER.

If `on` is selected, the absolute pressure p_a will be displayed/input/transmitted.

If `off` is selected, the relative pressure p_g will be displayed/input/transmitted.

$$p_g = p_a - 1.01 \text{ bar}$$

The pressure and its unit of measurement will, e.g., be displayed in the program branch `Parameter`. It is followed by the selected pressure, indicated in parentheses:

a – absolute pressure

g – relative pressure

```
Fluid pressure
  1.00 bar(a)
```

19.2 Measurement settings

Special Funct.\SYSTEM settings\Measuring

- Select the menu item Special Funct.\SYSTEM settings\Measuring.
- Press ENTER.

Notice!

The settings will be stored at the end of the dialog. If the menu item is quit by pressing key BRK, the changes will not be stored.

Special Funct.\...\Measuring\Enable NoiseTrek

- Select *on* to enable the NoiseTrek mode, *off* to disable it.
- Press ENTER.

Special Funct.\...\Measuring\Compare c-fluid

- Select *yes* if the measured sound speed is to be compared to the theoretical or expected value.
- Press ENTER.

The difference $\delta c = c_{\text{mea}} - c_{\text{stored}}$ between the two sound speeds will be displayed in the lower line during the measurement. c_{stored} is the sound speed of the reference fluid stored in the database.

- Press key during the measurement to scroll to the display of δc .

Special Funct.\...\Measuring\ProfileCorr 2.0

- Select a list item:
 - *off*: profile correction 1.0
 - *on*: profile correction 2.0 at ideal inflow conditions (default)
 - *With disturbance*: profile correction 2.0 at non ideal inflow conditions
- Press ENTER.

```
Special Funct.\...\Measuring\Flow Velocity
```

- Select `normal` to display and transmit the profile corrected flow values, `uncorr.` to display and output the flow values without flow profile correction.
- Press ENTER.

For further information, see section 17.7.

```
Special Funct.\...\Measuring\Velocity limit
```

An upper limit for the flow velocity can be entered, see section 17.4.

- Enter zero to deactivate the flow velocity check.
- Press ENTER.

```
Special Funct.\...\Measuring\Cut-off Flow
```

A lower limit for the flow velocity can be entered.

- Select `sign` to define a cut-off flow depending on the flow direction. One limit is set for the positive and negative flow velocity.
- Select `absolut` to define a cut-off flow independent of the flow direction. A limit is set for the absolute value of the flow velocity.
- Press ENTER.
- Select `factory` to use the default limit of 2.5 cm/s (0.025 m/s) for the cut-off flow.
- Select `user` to enter the cut-off flow.
- Press ENTER.

If `Cut-off Flow\sign` and `user` are selected, 2 values have to be entered:

```
Special Funct.\...\Measuring\Cut-off Flow\+Cut-off Flow
```

- Enter the cut-off flow.
- Press ENTER.

All positive values of the flow velocity smaller than this limit are set to zero.

```
Special Funct.\...\Measuring\Cut-off Flow\ -Cut-off Flow
```

- Enter the cut-off flow.
- Press ENTER.

All negative values of the flow velocity greater than this limit will be set to zero.

If `Cut-off Flow\absolut` and `user` are selected, only one value have to be entered:

```
Special Funct.\...\Measuring\Cut-off Flow
```

- Enter the cut-off flow.
- Press ENTER.

The absolute value of all flow velocity values lower than this limit will be set to zero.

```
Special Funct.\...\Measuring\Heat Quantity
```

The thermal energy is the totalizer of the thermal energy rate.

- Select the unit of measurement for the thermal energy (J or Wh).
- Press ENTER.

```
Special Funct.\...\Measuring\heat+flow quant.
```

- Select **on** to store and to output the values of the thermal energy totalizer and the volume totalizer during thermal energy rate measurement.
- Press ENTER.

```
Special Funct.\...\Measuring\Quant. wrapping
```

- Select the overflow behavior of the totalizers, see section 17.1.
- Press ENTER.

```
Special Funct.\...\Measuring\Quantity recall
```

- Select **on** to keep the previous totalizer values after a restart of the measurement.
- Select **off** to reset the totalizers to zero after a restart of the measurement.
- Press ENTER.

```
Special Funct.\...\Measuring\Toggle totalizer
```

It is possible to set a time period after which the display toggles between the positive and the negative totalizer during the measurement.

- Enter a time interval between 0 (off) and 5 s.
- Press ENTER.

```
Special Funct.\...\Measuring\Turbulence mode
```

The activation of the turbulence mode can enhance the signal quality if the flow is highly turbulent (e.g., in the vicinity of an elbow or valve). An SNR value of min. 6 dB is required during the measurement.

- Select `on` to activate the turbulence mode.
- Press ENTER.

19.3 Working with parameter records

19.3.1 Introduction

Parameter records are data sets that contain all information necessary to perform a certain measurement task:

- pipe parameters
- transducer parameters
- fluid parameter
- output options

Working with parameter records will make repeated measurement tasks easier and faster. The transmitter can store max. 14 parameter records.

Notice!

No parameter records are stored in the delivery state. Parameter records are entered manually.

The parameters have first to be entered in the program branch `Parameter`. Afterwards, they can be stored as parameter record.

```
Special Funct.\Store Curr.Rec.
```

- Select the menu item `Special Funct.\Store Curr.Rec.`
- Press ENTER.

The error message `NO DATA!` will be displayed if no complete parameter record is available. Storing is impossible.

- Enter the missing parameters in the program branch `Parameter`.

```
Special Funct.\Store Curr.Rec.\Store Par. To:
```

14 parameter records (`Par.Record 01...Par.Record 14`) can be stored.

- Select a parameter record.
- Press ENTER.

If parameters are already stored in the selected parameter record, they can be overwritten.

```
Special Funct.\Store Curr.Rec.\Store Par. To:\Overwrite
```

- Select `yes` to overwrite the parameters, or `no` to select another parameter record.
- Press ENTER.

19.3.2 Load of a parameter record

Stored parameter records can be loaded and used for measurement.

```
Parameter\for Channel A
```

- Select the program branch `Parameter`.
- Press ENTER.
- Select the channel for which a parameter record is to be loaded.
- Press ENTER.

```
Parameter\for Channel A\Parameter from\Par.Record 01
```

- Select the parameter record to be loaded.
- Press ENTER.

19.3.3 Deletion of parameter records

```
Special Funct.\Delete Para.Rec.
```

- Select the menu item `Special Funct.\Delete Para.Rec.`
- Press ENTER.

If no parameter record is stored, the message `NO PAR. STORED!` will be displayed.

```
Special Funct.\Delete Para.Rec.\Delete
```

- Select the parameter record to be deleted.
- Press ENTER.

```
Special Funct.\Delete Para.Rec.\Delete\Really Delete?
```

- Confirm the deletion of the parameter record.
- Press ENTER.

19.4 Libraries

The internal material database of the transmitter contains parameters for pipe and lining materials as well as for fluids.

The material and fluid scroll list displayed in the program branch `Parameter` can be arranged. Shorter scroll lists make work more effective.

```
Special Funct.\SYSTEM settings\Libraries
```

- Select the menu item `Special Funct.\SYSTEM settings\Libraries`.
- Press ENTER.

```
Special Funct.\SYSTEM settings\Libraries\Material list
```

- Select `Material list` to edit the material scroll list or `Medium list` to edit the fluid scroll list.
- Select `go back` to return to the menu item `SYSTEM settings`.
- Press ENTER.
- Select `factory` if all materials/fluids of the internal database are to be displayed in the scroll list. An already existing scroll list will not be deleted but only deactivated.
- Select `user` to activate the user defined scroll list.
- Press ENTER.

```
Special Funct.\...\Material list\user>Show list
```

If `user` is selected, the material or fluid scroll list can be edited, see section 19.4.1...19.4.3.

```
Special Funct.\...\Material list\user\End of Edit
```

- Select `End of Edit` to stop editing.
- Press ENTER.

```
Special Funct.\...\Material list\user\Save List?
```

- Select `yes` to store all changes of the scroll list or `no` to quit the menu item without storing.
- Press ENTER.

Notice!

If the material/fluid scroll list is quit by pressing key BRK before storing, all changes will be lost.

19.4.1 Displaying a scroll list

```
Special Funct.\...\Material list\user>Show list
```

- Select `Show list`.
- Press ENTER to display the scroll list as in the program branch `Parameter`.

```
Special Funct.\...\Material list\user>Show list\Current list ↓
```

The current scroll list is displayed in the lower line.

- Press ENTER to return to the scroll list `Material list` or `Medium list`.

19.4.2 Adding a material/fluid to the scroll list

```
Special Funct.\...\Material list\user\Add Material
```

- Select `Add Material` or `Add Medium` to add a material/fluid to the scroll list.
- Press ENTER.

All materials/fluids that are not contained in the current scroll list will be displayed in the lower line.

```
>Add Material ↓
Stainless Steel
```

- Select the material/fluid.
- Press ENTER. The material/fluid is added to the scroll list.

Notice!

The materials/fluids are displayed in the order in which they have been added.

19.4.3 Adding all materials/fluids to the scroll list

```
Special Funct.\...\Material list\user\Add all
```

- Select `Add all` to add all materials/fluids of the database to the current scroll list.
- Press ENTER.

19.4.4 Removing a material/fluid from the scroll list

```
Special Funct.\...\Material list\user\Remove Material
```

- Select `Remove Material` or `Remove Medium` to remove a material/fluid from the scroll list.
- Press ENTER.

All materials/fluids of the current scroll list will be displayed in the lower line.

```
>Remove Material ↓
Stainless Steel
```

- Select the material/fluid.
- Press ENTER. The material/fluid will be removed from the scroll list.

Notice!

User defined materials/fluids will always be displayed in the scroll lists of the program branch `Parameter`. They cannot be removed.

19.4.5 Removing all materials/fluids from the scroll list

```
Special Funct.\...\Material list\user\Remove all
```

- Select `Remove all` to remove all materials/fluids from the scroll list.
- Press ENTER. User defined materials/fluids will not be removed.

19.5 Contrast settings

```
Special Funct.\SYSTEM settings\Miscellaneous
```

- Select the menu item `Special Funct.\SYSTEM settings\Miscellaneous`.
- Press ENTER.

```
Special Funct.\SYSTEM settings\Miscellaneous\SETUP DISPLAY
```

- Select the menu item `Special Funct.\SYSTEM settings\Miscellaneous` to set the display contrast of the transmitter.

The display contrast is adjusted with the following keys:

- `6` increases the contrast
- `4` reduces the contrast
- `2` sets to min. contrast
- `5` sets to medium contrast
- `8` sets to max. contrast

- Press ENTER.

It is possible to reset the display to medium contrast by means of a HotCode.

- Enter the HotCode **555000** immediately after the transmitter has been switched on.

Notice!

After an initialization of the transmitter, the display is reset to medium contrast.

20 Wall thickness measurement (optional)

Caution!



Touching hot or cold surfaces

This may result in injuries (e.g., thermal damages).

- Observe the ambient conditions at the measuring point during installation.
- Wear the required personal protective equipment.
- Observe the applicable rules.

If the transmitter has the optional wall thickness measurement, the wall thickness and the longitudinal sound speed of the pipe can be measured. In this case, a wall thickness probe that can be connected directly to the socket of a measuring channel will be included in shipment. The wall thickness probe will be detected automatically when connected to the transmitter. The measured wall thickness can be transmitted directly into the current parameter record.

A modified transit time method is used to determine the wall thickness or the sound speed of the pipe.

- The wall thickness probe emits an ultrasonic pulse which propagates in the pipe.
- The pulse is reflected by the boundary layer of the pipe and received by the wall thickness probe.
- The time difference between emitting and receiving the signal is a measure of the pipe wall thickness (if the sound speed of the material is known) or of the longitudinal sound speed of the pipe (if the wall thickness is known).

Fig. 20.1: Measurement principle

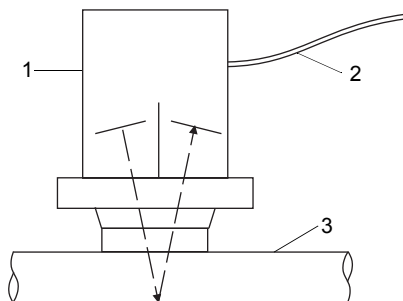

- 1 – wall thickness probe
- 2 – cable
- 3 – pipe

Notice!

With some few exceptions, the transversal sound speed of a material is approx. 30...60 % of the longitudinal sound speed.

20.1 Orientation of the wall thickness probe

When measuring on pipes or cylindrical vessels, the probe has to be pressed centrally against object. The applied pressure has to be constant. The acoustic partition boundary of the wall thickness probe has to be perpendicular to the longitudinal axis of the pipe, see Fig. 20.2.

Fig. 20.2: Orientation of the wall thickness probe

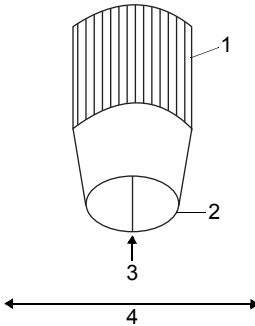

- 1 – wall thickness probe
- 2 – contact surface
- 3 – acoustic partition boundary
- 4 – pipe axis

20.2 Activation of the wall thickness measurement

- Connect the wall thickness probe to the measuring channel A or B.

The wall thickness measuring mode is activated automatically. A message is displayed that the wall thickness probe has been detected.

```
*WALL THICKNESS*
*DETECTED ON A:*
```

The main menu of the wall thickness measurement is displayed. The menu structure is similar to the structure of the flow measurement. The program branches are adapted to the wall thickness measurement.

Notice!

The wall thickness measurement mode will remain activated as long as the wall thickness probe is connected to the measuring channel.

20.3 Parameter input**20.3.1 Parameter input for the wall thickness measurement**

The sound speed of the pipe material has to be entered to measure the wall thickness.

Output Options\Physic. Quant.\Wall Thickness

- Select in the menu item `Output Options\Physic. Quant.` the physical quantity `Wall Thickness` for the measuring channel to which the wall thickness probe is connected.

Pipe material

Parameter\Pipe Material

- Select the pipe material in the menu item `Parameter\Pipe Material`.
- If the material is not in the list, select `Other Material`.
- Press ENTER.

Fluid temperature

Parameter\Medium Temperat.

- Enter the fluid temperature.
- Press ENTER.

This display will not be indicated if `Other Material` is selected.

c-LONGITUDINAL
5800.0 m/s

A value for the longitudinal sound speed of the selected material is recommended. If `Other Material` has been selected, 0.0 m/s will be displayed.

- Enter the sound speed, if necessary.
- Press ENTER.

Notice!

The measurement can only be started if the entered sound speed is > 0 .

Compared to the flow measurement, the sound speed has a great, approximately linear influence on the measuring result. The input of a 10 % higher sound speed will result in a wall thickness which is approx. 10 % too high.

The actual sound speed of a material often differs substantially from the values published in the literature as it depends on the composition, the manufacturing process and the temperature. The sound speed values given in the annex, section C.1.

Notice!

The longitudinal sound speed of a material can be precisely measured using a reference object of known thickness, see section 20.4.2.

20.3.2 Parameter input for the sound speed measurement

The thickness of the pipe has to be entered to determine the longitudinal sound speed of a material.

```
Output Options\Physic. Quant.\c-LONGITUDINAL
```

- Select in the menu item `Output Options\Physic. Quant.` the physical quantity `c-LONGITUDINAL` for the measuring channel to which the wall thickness probe is connected.

```
Parameter\Wall Thickness
```

- Select the menu item `Parameter\Wall Thickness`.
- Enter the pipe wall thickness.

20.4 Measurement

```
Measuring
```

- Select the program branch `Measuring` in the main menu.
- Press ENTER.

```
Measuring\NO DATA!
```

This error message will be displayed if the entered parameters are not complete.

20.4.1 Measurement of the wall thickness

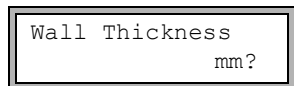

This display is indicated if the wall thickness is selected as the physical quantity for the measuring channel connected to the probe.

As long as there is no valid measured value, the unit of measurement and a question mark will be displayed in the lower line.

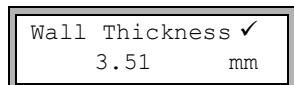

- Apply a thin film of the coupling compound to the pipe wall.
- Press the wall thickness probe against the pipe wall in this position.

As soon as a valid measured value is obtained, it will be displayed in the lower line. A tick will be displayed in the upper line on the right.

The measured value remains on the display when the wall thickness probe is removed from the pipe.

To minimize errors when measuring the wall thickness, measure the longitudinal sound speed on a reference object of the same material with known dimensions.

- The reference object should be even and smooth.
- The thickness of the reference object should be comparable to the max. thickness of the pipe.

Notice!

The sound speed of the material depends on the temperature. Therefore, the sound speed of a reference object should be measured at the place where the flow will be measured later to obtain the sound speed at the correct temperature.

20.4.2 Measurement of the sound speed

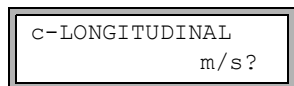

This display will be indicated if the sound speed is selected as measurand for the measuring channel connected to the wall thickness probe.

As long as there is no valid measured value, the unit of measurement and a question mark will be displayed in the lower line.

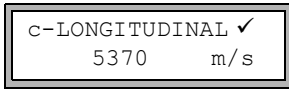

- Apply a thin film of the coupling compound to the pipe wall.
- Press the wall thickness probe against the pipe wall in this position.

As soon as a valid measured value is obtained, it will be displayed in the lower line. A tick will be displayed in the upper line on the right.

The measured value remains on the display when the wall thickness probe is removed from the pipe.

Notice!

For pipe materials whose longitudinal sound speed can be used for the measurement of the volumetric flow rate see annex, section C.1.

20.4.3 Further information concerning the measurement

- Press key to obtain information on the measuring signal.

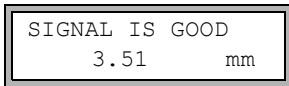

This message will be displayed if the measuring signal is sufficient. The LED of the measuring channel lights green.



This message will be displayed if the measuring signal is not sufficient (# = number). The LED of the measuring channel lights red.

- Press key again. The bar graph of the signal quality (Q=) will be displayed.

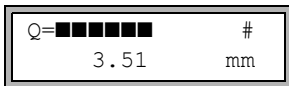

If the signal is not sufficient for measurement, UNDEF will be displayed. The LED of the measuring channel lights red.

- Shift the wall thickness probe slightly on the pipe until the LED of the measuring channel lights green.
- Press key to display the transit time of the signal.

Wall Thickness
LZ= 186 ns

20.4.4 Errors during the measurement

If no valid wall thickness can be measured:

- remove the wall thickness probe from the pipe wall
- clean the wall thickness probe and the place where the measurement takes place
- apply a thin film of the coupling compound to the pipe wall
- press the wall thickness probe against the pipe wall in this position
- try to measure again

Notice!

Use a small amount of coupling compound. Press the wall thickness probe evenly against the pipe wall.

20.4.5 Possible reasons for incorrect measuring results

- **temperature fluctuations:**

The sound speed is temperature dependent.

- **doubling effect:**

When measuring the wall thickness using ultrasonic signals, a phenomenon called doubling effect can occur if the wall thickness is smaller than the min. value of the measuring range of the probe. The measured value is then twice (or sometimes 3 times) as high as the actual wall thickness because of repeated reflections of the ultrasonic signal.

- **the measured value is too low:**

The ultrasonic signal was reflected by a defect and not by the boundary layer, resulting in a shorter transit time and therefore a lower wall thickness.

- **curved surfaces:**

The probe has to be pressed centrally against the pipe or cylindrical vessel. The applied pressure has to be constant. The acoustic partition boundary of the wall thickness probe has to be perpendicular to the longitudinal axis of the pipe, see Fig. 20.2.

- **surface conditions:**

Regular unevenness (e.g., small grooves) on the surface of the pipe can result in wrong measured values. Normally, this problem can be avoided by turning the wall thickness probe in such way that its acoustic partition boundary is perpendicular to the orientation of the grooves, see Fig. 20.2.

When measuring on a rough surface, applying too much of the coupling compound can result in wrong measured values. A measurement on a very rough surface might be impossible (the message `NO COUPLING` will be displayed). In this case, the surface has to be smoothed.

20.4.6 Storing/transmission of the wall thickness

- Press ENTER to stop the measurement and to store or output the measured value.

The following display appears if a valid wall thickness has been measured and the transmission of measured value is activated:

```
Transfer Data
no          >YES<
```

- Select `yes` to store and/or output the measured value.

The wall thickness can be transmitted into the current parameter record.

The pipe material will be replaced by the material used for the wall thickness measurement.

If the serial transmission is activated, the measured value will be transmitted.

20.4.7 Stop of the wall thickness measurement

- In order to quit the wall thickness measurement mode, disconnect the wall thickness measurement from the transmitter.

21 Heat flow measurement

If the transmitter has the optional heat quantity measurement and 2 temperature inputs, the heat flow can be measured. A temperature probe is fixed on the supply and the return line.

The transducers are fixed on the return line, see Fig. 21.1. If this is not possible, they can also be mounted on the supply line, see Fig. 21.2.

Fig. 21.1: Heat flow measurement on return line

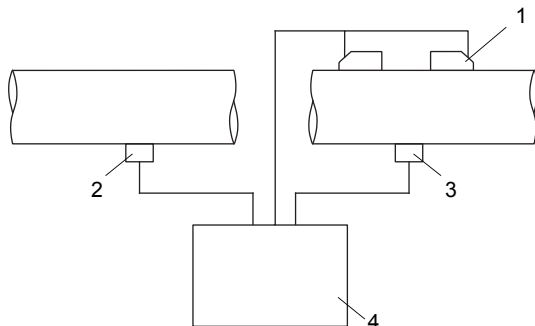

- 1 – transducers on return line
- 2 – temperature probe on supply line (temperature input T1)
- 3 – temperature probe on return line (temperature input T2)
- 4 – transmitter

Fig. 21.2: Heat flow measurement on supply line

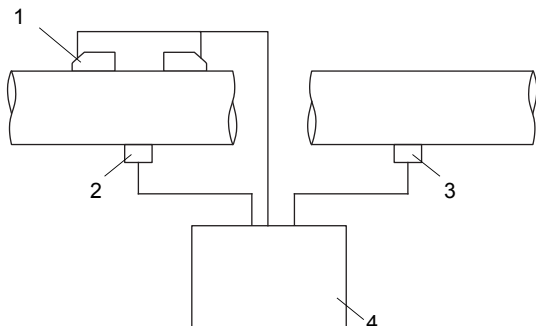

- 1 – transducers on supply line
- 2 – temperature probe on supply line (temperature input T1)
- 3 – temperature probe on return line (temperature input T2)
- 4 – transmitter

For the thermal energy rate measurement, 2 different measuring modes can be used:

- The normal measuring mode can be used if in a heating application the transducers are mounted on the return line.
- The BTU mode facilitates the measurement with other configurations (e.g., if the transducers are mounted on the supply line or in a cooling application) and offers additional units of measurement for the thermal energy rate.

A temperature correction value (offset) can be set for each temperature input.

If the supply or return temperature is known and constant during the whole measurement, this temperature can be entered as a constant value. In this case, the corresponding temperature probe does not need to be connected.

If the supply pressure is constant or can be measured with an additional input, the thermal energy rate can be determined for a fluid that is vaporous in the supply line, see section 21.6.

In the SuperUser mode, it is possible to define a temperature-based cut-off flow of the thermal energy rate, see section 18.8.

The thermal energy is the totalizer of the thermal energy rate.

21.1 Calculation of the heat flow

The heat flow is calculated with the following formula:

$$\Phi = k_i \cdot \dot{V} \cdot (T_V - T_R)$$

where

Φ – heat flow

k_i – heat coefficient

\dot{V} – volumetric flow rate

T_V – supply temperature

T_R – return temperature

The heat coefficient k_i is calculated from several heat flow coefficients for the specific enthalpy and the density of the fluid. The heat coefficients of some fluids are stored in the internal database of the transmitter.

21.2 Normal measuring mode

The supply and return temperature have to be assigned to the measuring channels as T-Inlet and T-Fluid/Outle. The temperatures can be measured or entered as constant values.

21.2.1 Flow measurement on the return line

The temperature inputs are configured as follows:

```
Special Funct.\SYSTEM settings\Proc. inputs\Link temperature
```

- Select the menu item Special Funct.\SYSTEM settings\Proc. inputs\Link temperature.
- Press ENTER.

```
Special Funct.\...\Link temperature\T-Inlet\Input T1
```

- Select the list item Input T1 to assign the temperature probe on the supply line to the temperature input T1.
- Press ENTER.

```
Special Funct.\...\Link temperature\T-Fluid/Outle\Input T2
```

- Select the list item Input T2 to assign the temperature probe on the return line to the temperature input T2.
- Press ENTER.

21.2.2 Flow measurement on the supply line

The temperature inputs, see Fig. 21.1, are configured as follows:

```
Special Funct.\SYSTEM settings\Proc. inputs\Link temperature
```

- Select the menu item Special Funct.\SYSTEM settings\Proc. inputs\Link temperature.
- Press ENTER.

```
Special Funct.\...\Link temperature\T-Inlet\Input T2
```

- Select the list item Input T2 to assign the temperature probe on the supply line to the temperature input T2 (even though it is connected to the temperature input T1).
- Press ENTER.

```
Special Funct.\...\Link temperature\T-Fluid/Outle\Input T1
```

- Select the list item `Input T1` to assign the temperature probe on the return line to the temperature input T1 (even though it is connected to the temperature input T2).
- Press ENTER.

The measuring values of the thermal energy rate will be displayed with the opposite sign during the measurement.

Fig. 21.3: Display of the thermal energy rate

A:Heatflow	↓
-123.45	kW

21.2.3 Input of a constant temperature

If the supply or return temperature is known and constant during the whole measurement, this temperature can be entered as a constant value.

The temperature inputs are configured as follows:

```
Special Funct.\SYSTEM settings\Proc. inputs\Link temperature
```

- Select the menu item `Special Funct.\SYSTEM settings\Proc. inputs\Link temperature`.
- Press ENTER.

```
Special Funct.\...\Link temperature\T-Inlet\Fixed input val.
```

- Select the list item `Fixed input val.` if the supply temperature is known and constant.
- Press ENTER.

```
Special Funct.\...\Link temperature\T-Fluid/Outle\Fixed input val.
```

- Select the list item `Fixed input val.` if the return temperature is known and constant.
- Press ENTER.
- Repeat the steps for all measuring channels on which a measurement is being made.

The constant value of the temperature is entered in the program branch `Measuring be` before the start of the measurement.

21.2.4 Definition of the physical quantity and the unit of measurement

Output Options\for Channel A

- Select the channel in the program branch `Output Options` on which the thermal energy rate is to be measured (the channel to which the temperature inputs have been assigned).
- Press ENTER.

Output Options\...\Physic. Quant.\Heatflow

- Select `Heatflow` as physical quantity.
- Press ENTER.
- Select the unit of measurement to be used for the thermal energy rate.
- Press ENTER.

Notice!

The physical quantity `Heatflow` will only be displayed in the program branch `Output Options` of a measuring channel if the supply and return temperature have been assigned to this channel.

Special Funct.\SYSTEM settings\Measuring\Heat Quantity

- If the thermal energy is also to be measured, select the menu item `Special Funct.\SYSTEM settings\Measuring`.
 - Press ENTER until `Heat Quantity` is displayed.
 - Select the unit of measurement (`J` or `Wh`).
- Press ENTER.

21.3 BTU mode

The BTU mode (BTU = British Thermal Unit) is a measuring mode that is designed specifically for the thermal energy rate measurement. In the BTU mode, the position of the transducers and the application can be assigned to avoid receiving the opposite sign of the measured values.

21.3.1 Activation/deactivation of the BTU mode

- Enter the HotCode **007025** immediately after the transmitter has been switched on.

```
Act as BTU-meter
```

- Select `on` to activate the BTU mode, `off` to deactivate it.
- Press ENTER.

Notice!

The BTU mode remains activated after a restart of the transmitter.

21.3.2 Assignment of the transducers and the temperature inputs

The position of the transducers and the temperature inputs can be assigned in accordance with the application.

Select the menu item `Special Funct.\SYSTEM settings\Proc. inputs\Link temperature`.

```
Special Funct.\SYSTEM settings\Proc. inputs\Link temperature
```

- Select the menu item `Special Funct.\SYSTEM settings\Proc. inputs\Link temperature`.
- Press ENTER.

```
Special Funct.\...\A:Thermal energy
```

- In case of a heating application, select `heat`, in case of a cooling application `chill`.
- Press ENTER.

```
Special Funct.\...\Transd. Location
```

- Select `return`, if the transducers are mounted on the return line or `supply`, if the transducers are mounted on the supply line.
- Press ENTER.

```
Special Funct.\...\Thermal energy
```

- Select `sign` if the sign of the thermal energy rate is to be considered, `absolute`, if the absolute value of the thermal energy rate is to be displayed.
- Press ENTER.

```
Special Funct.\...\With PhaseChange
```

- Select `yes` if the aggregate state of the fluid changes between the return and supply line. Select `no` if it does not change.
- Press ENTER.

```
Special Funct.\...\A:T-Supply\Input T1
```

- Select the temperature input to be assigned to the supply temperature.
- Press ENTER.

```
Special Funct.\...\A:T-Return\Input T2
```

- Select the temperature input to be assigned to the return temperature.
- Press ENTER.

21.3.3 Input of a constant temperature

If the supply or return temperature is known and constant during the whole measurement, this temperature can be entered as a constant value.

The temperature inputs are configured as follows:

```
Special Funct.\SYSTEM settings\Proc. inputs\Link temperature
```

- Select the menu item `Special Funct.\SYSTEM settings\Proc. inputs\Link temperature`.
- Press ENTER.

```
Special Funct.\...\Link temperature\T-Inlet\Fixed input val.
```

- Select the list item `Fixed input val.` if the supply temperature is known and constant.
- Press ENTER.

```
Special Funct.\...\Link temperature\T-Fluid/Outle\  
Fixed input val.
```

- Select the list item `Fixed input val.` if the return temperature is known and constant.
 - Press ENTER.
 - Repeat the steps for all measuring channels on which a measurement is being made.
- The constant value of the temperature is entered in the program branch `Measuring be-` before the start of the measurement.

21.3.4 Definition of the physical quantity and the unit of measurement

```
Output Options\for Channel A
```

- Select the channel in the program branch `Output Options` on which the thermal energy rate is to be measured (the channel to which the temperature inputs have been assigned).
- Press ENTER.

```
Output Options\...\Physic. Quant.\Thermal energy
```

- Select `Thermal energy` as physical quantity.
- Press ENTER.
- Select the unit of measurement to be used for the thermal energy rate.
- Press ENTER.

In the BTU mode, additional units of measurement are available for the thermal energy rate and the thermal energy. The unit of measurement displayed during the measurement will be adjusted automatically:

unit of measurement of the thermal energy rate	unit of measurement of the thermal energy
kBTU/min	kBTU
kBTU/h	kBTU
MBTU/h	MBTU
kBTU/day	MBTU
TON (TH)	TH
TON (TD)	TD
kTON (kTH)	kTH
kTON (kTD)	kTD

21.3.5 Automatic display toggling in the lower line

In the BTU mode, it is possible to activate automatic toggling of the display in the lower line.

Activation

- Press key  3 times during the measurement.

The following physical quantities will be displayed at an interval of 3 s:

- physical quantity selected in the program branch `Output Options`
- fluid temperature in the supply line
- fluid temperature in the return line
- difference between the fluid temperatures in the supply line and return line

Deactivation

- Press key  3 times during the measurement.

21.4 Measurement

- Start the measurement as usual.

If no thermal energy rate coefficients are available for the selected fluid, an error message will be displayed.

```
Heatflow
*INVALID MEDIUM*
```

The two temperature inputs are checked and the measured temperatures are displayed. Press ENTER.

```
T1= 90.2      C
T2= 70.4      C
```

If a temperature cannot be measured (the temperature probe is not connected or is defective), the error message `?UNDEF` will be displayed.

```
T1=?UNDEF    C
T2= 70.4     C
```

If `Fixed input val.` is selected during the configuration of the temperature input, the temperature input (T_s) or the return temperature (T_r) have to be entered now.

For simulations, it is possible to enter both the supply and return temperatures as constants. In this case, do not connect the temperature probes to the transmitter.

- Enter the fluid temperature.
- Press ENTER.

```
A:Ts manualFIX
      0.0      C
```

The measured thermal energy rate (in BTU mode `Thermal energy`) is displayed.

```
A:Heatflow      ↑
      -123.45    kW
```

21.5 Two independent heat flow measurements

If the transmitter has 2 measuring channels and 4 temperature inputs for each measuring channel, it is possible to conduct 2 independent heat flow measurements at the same time. Tab. 21.1 shows a typical configuration of the temperature inputs.

Tab. 21.1: Configuration of the temperature inputs in case of 2 independent heat flow measurements

		temperature input
measuring channel A	supply temperature	T1 or constant value
	return temperature	T2 or constant value
	heat quantity measurement	possible
measuring channel B	supply temperature	T3 or constant value
	return temperature	T4 or constant value
	heat quantity measurement	possible

21.6 Steam in inlet

If the supply pressure is constant or can be measured with an additional input, the thermal energy rate can be determined for a fluid that is vaporous in the supply line.

The state of aggregation of the fluid is determined by means of the supply pressure and the supply temperature.

Notice!

The measurement of the volumetric flow rate and the thermal energy rate is only possible when the fluid is liquid in the return line.

The steam coefficient of water and ammonia are stored in the internal database of the transmitter. The steam coefficient of other fluids have to be entered with the program `FluxSubstanceLoader`.

21.6.1 Activation/deactivation

```
Special Funct.\SYSTEM settings\Dialogs/Menus\Steam in inlet
```

- Select the menu item `Special Funct.\SYSTEM settings\Dialogs/Menus\Steam in inlet`.
- Press ENTER.
- Select `on to deactivate Steam in inlet`. The state of aggregation of the fluid is determined by means of the supply pressure and the supply temperature of the fluid.
- Select `off to deactivate Steam in inlet`. The fluid is then always considered to be liquid in the supply line.
- Press ENTER.

```
Special Funct.\...\Steam in inlet\Inlet pressure
```

- If `Steam in inlet` is activated, the supply pressure has to be entered in the program branch `Parameter`.
- Enter the supply pressure.
- Press ENTER.

Notice!

The menu item `Steam in inlet` will always be displayed independently of the selected physical quantity. However, the supply pressure will only be used for the thermal energy rate measurement.

21.6.2 Display of the aggregation state

During the thermal energy rate measurement, the state of aggregation of the fluid can be displayed in the upper line by pressing the key .

display	explanation
S	aggregation state in the supply line
R	aggregation state in the return line
GAS	The fluid is completely gaseous.
LIQU	The fluid is completely liquid.
BOIL	<p>The fluid is in phase transition.</p> <p>In this case, an exact measurement of the thermal energy rate is not possible because the proportion of the fluid in liquid phase in the supply line has to be known in order to calculate the enthalpy of the supply.</p> <p>The critical range of water is defined as the range ± 3 °C around the boiling temperature. In the critical range, the steam saturation enthalpy is used to calculate the thermal energy rate.</p>

Example

A:S= GAS R= LIQU

The fluid in the supply line is completely gaseous. The fluid in the return line is completely liquid. A thermal energy rate measurement is possible.

Annex

A Menu structure

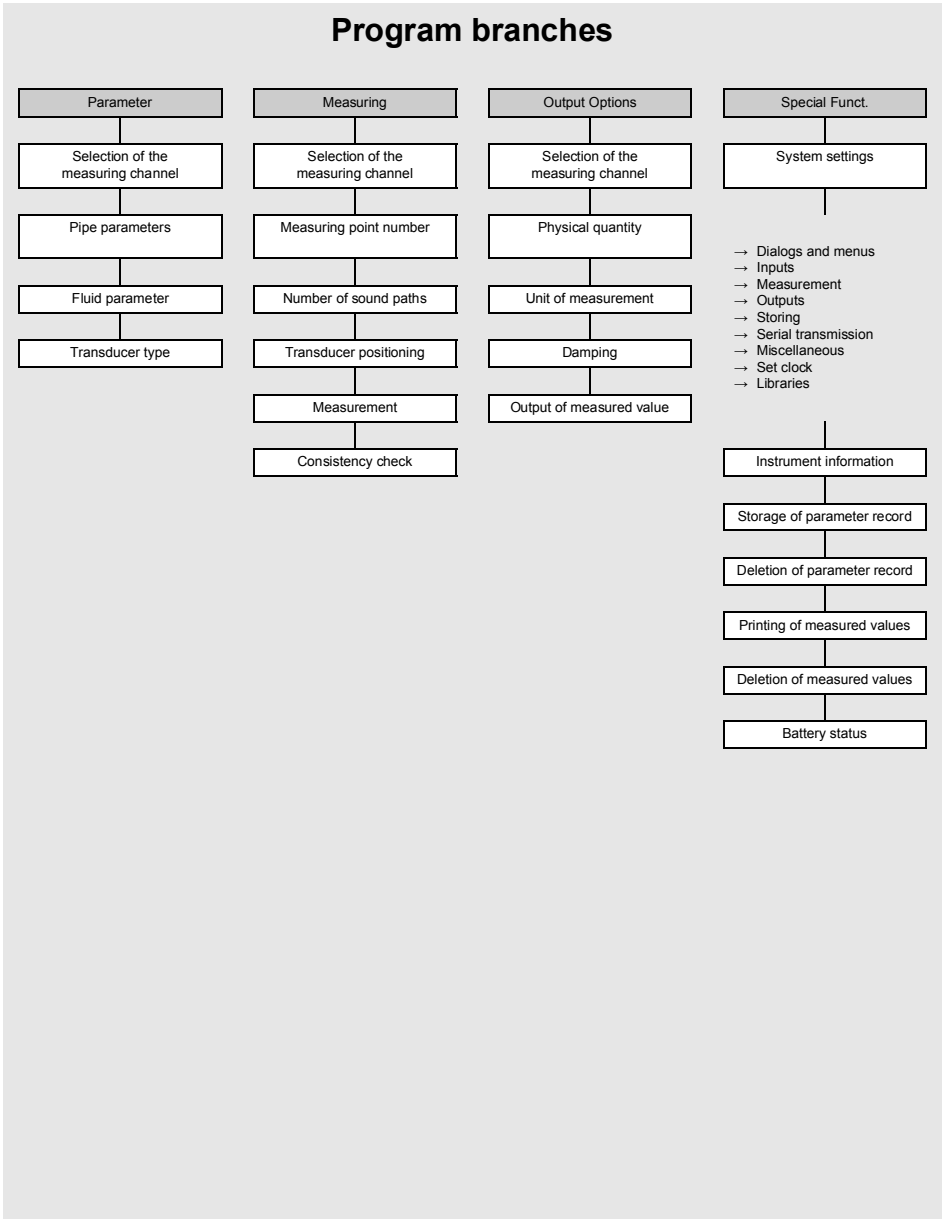

Parameter input

(see chapter 9)

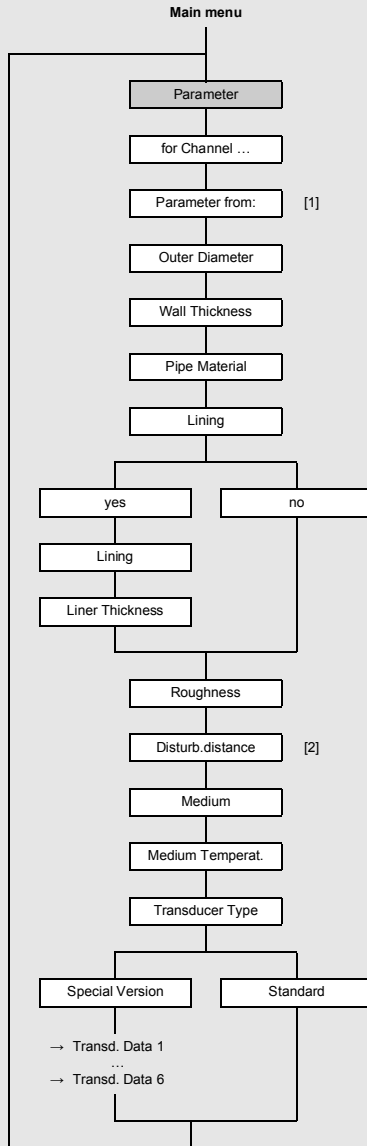

Legend

- [1] only if a parameter record is stored
- [2] only if With disturbance is selected in the menu item Special Funct.\SYSTEM settings\Measuring\ProfileCorr 2.0

Measurement settings

(see chapter 9)

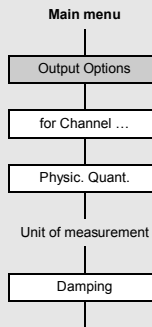

Data logger

(see chapter 15)

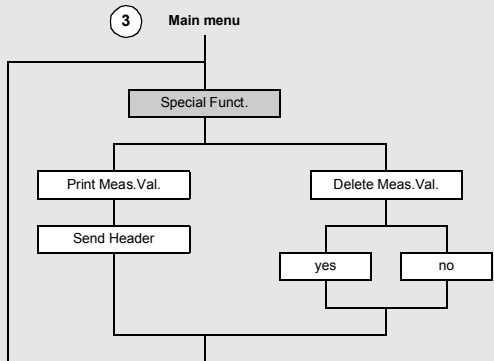
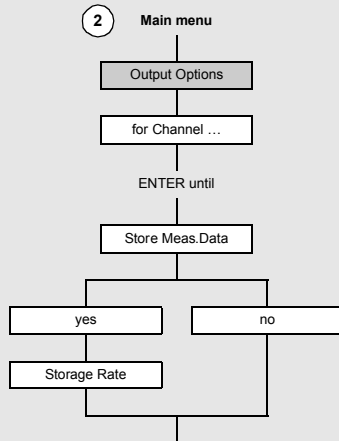
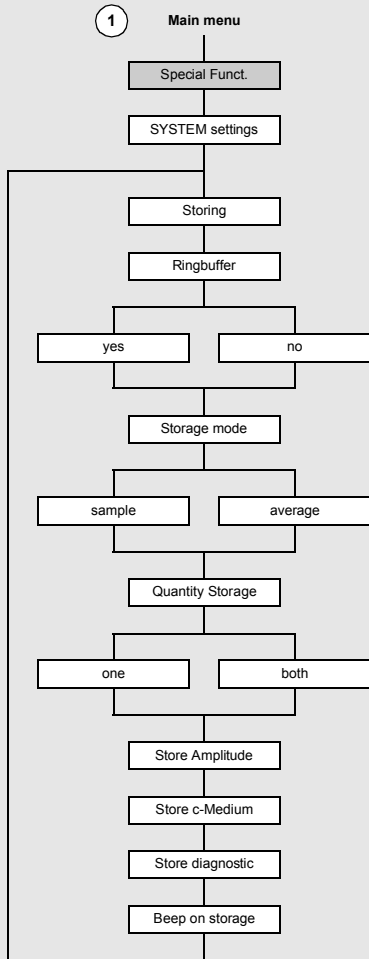

Measurement start

(see chapter 9)

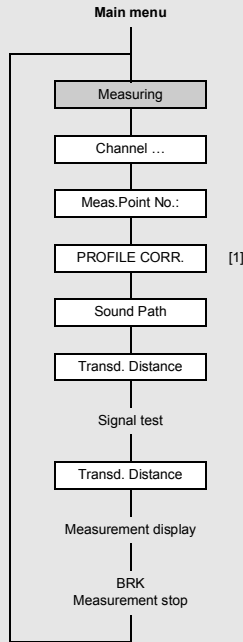

legend

[1] this will only be displayed if Special Funct.\SYSTEM settings\Measuring\Flow Velocity uncorr. is selected in the menu item

Configuration of the outputs

(see chapter 9)

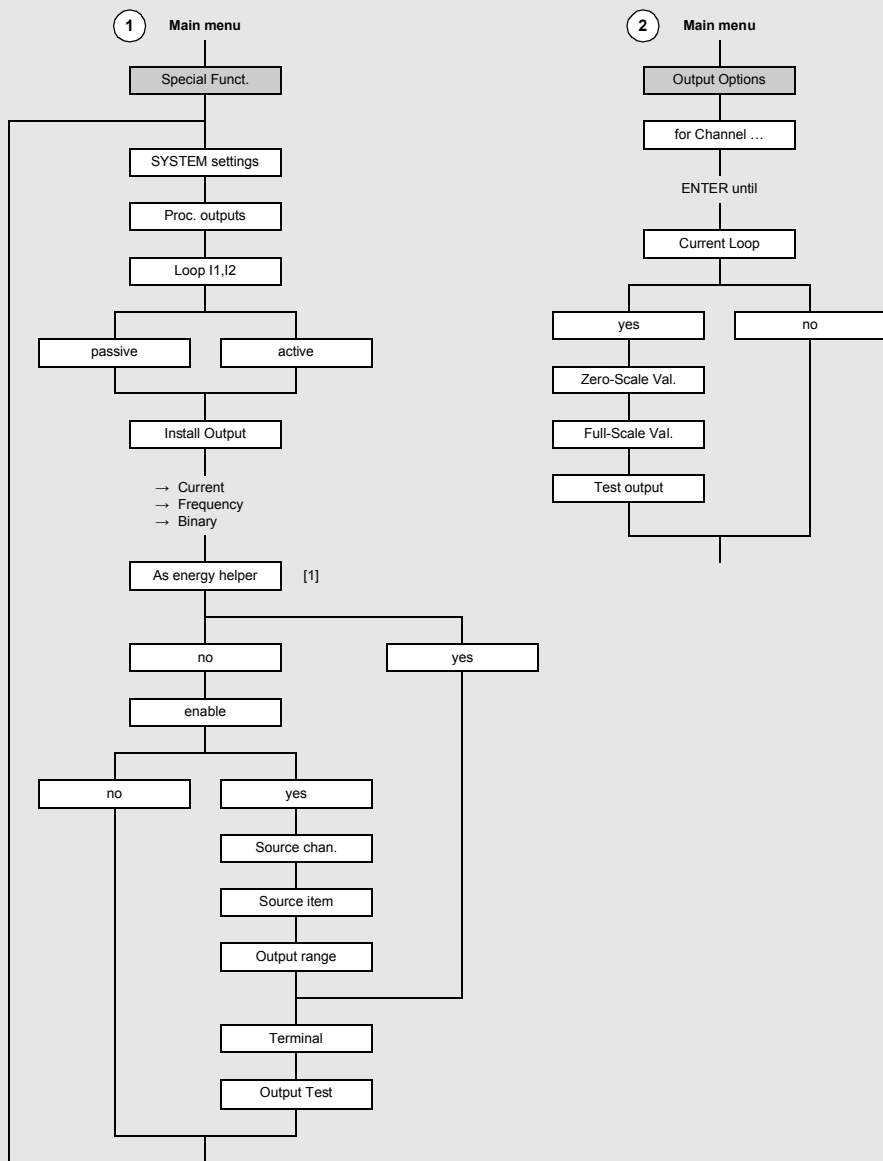

Legend

[1] this will only be displayed if Current and active are selected

Configuration of the inputs

(see chapter 14)

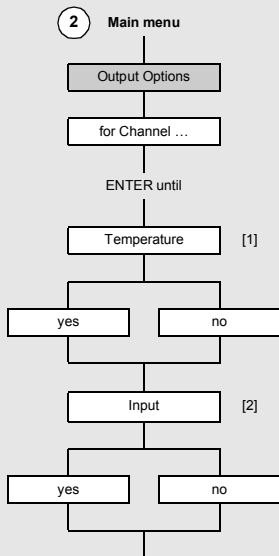
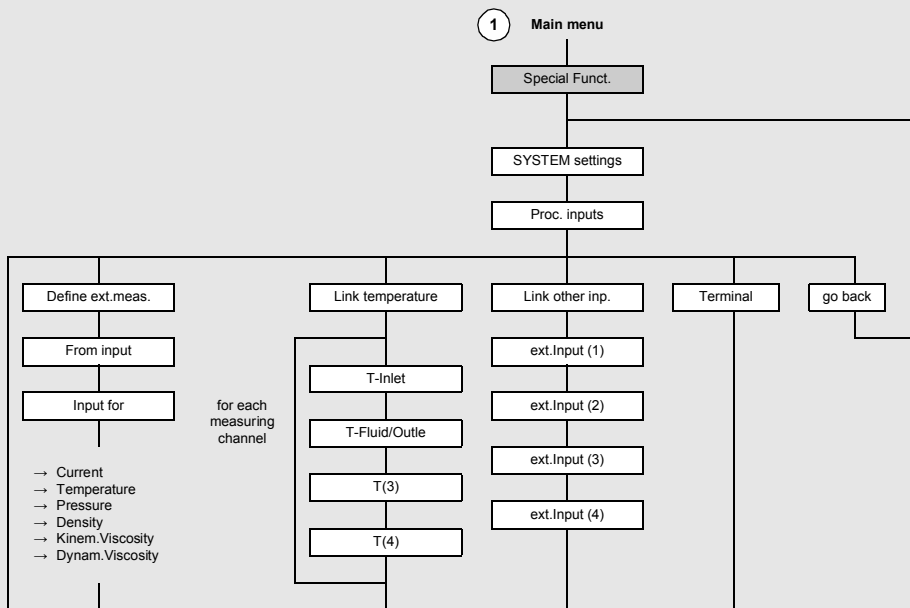

legend

- [1] all temperature inputs assigned to the channel will be displayed consecutively
- [2] all inputs assigned to the channel will be displayed consecutively

SuperUser mode

(see chapter 18)

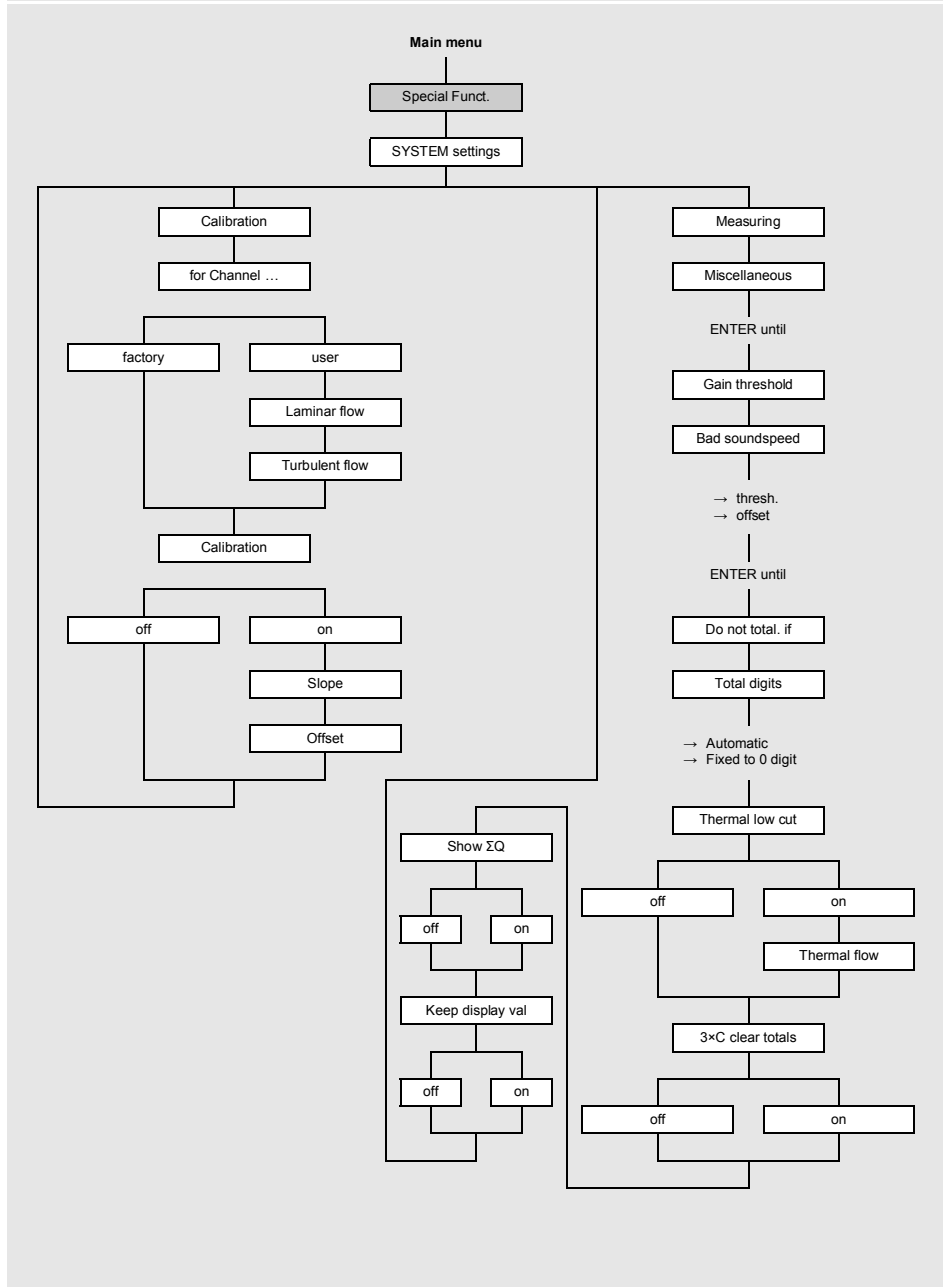

Thermal energy rate measurement

(see chapter 21)

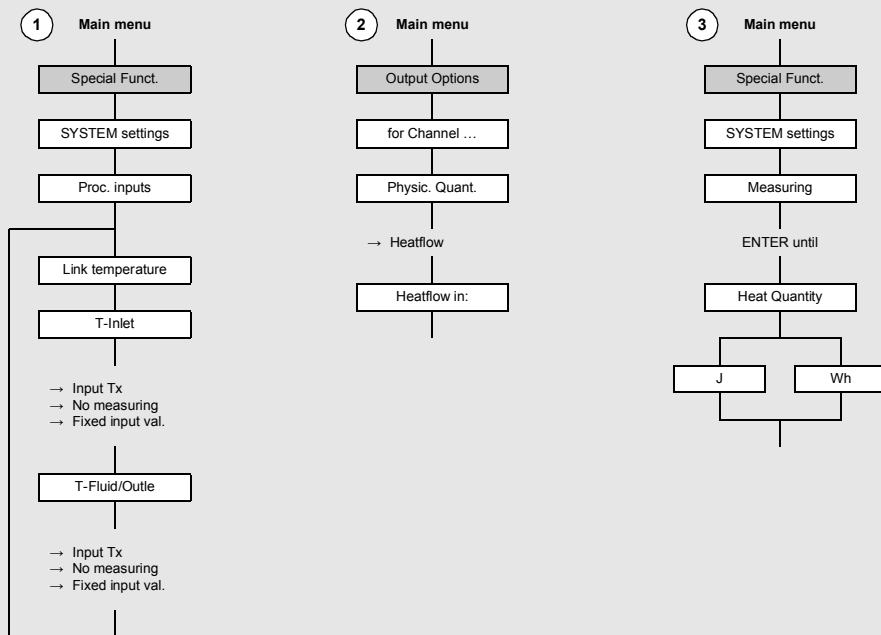

Alarm output

(see chapter 17)

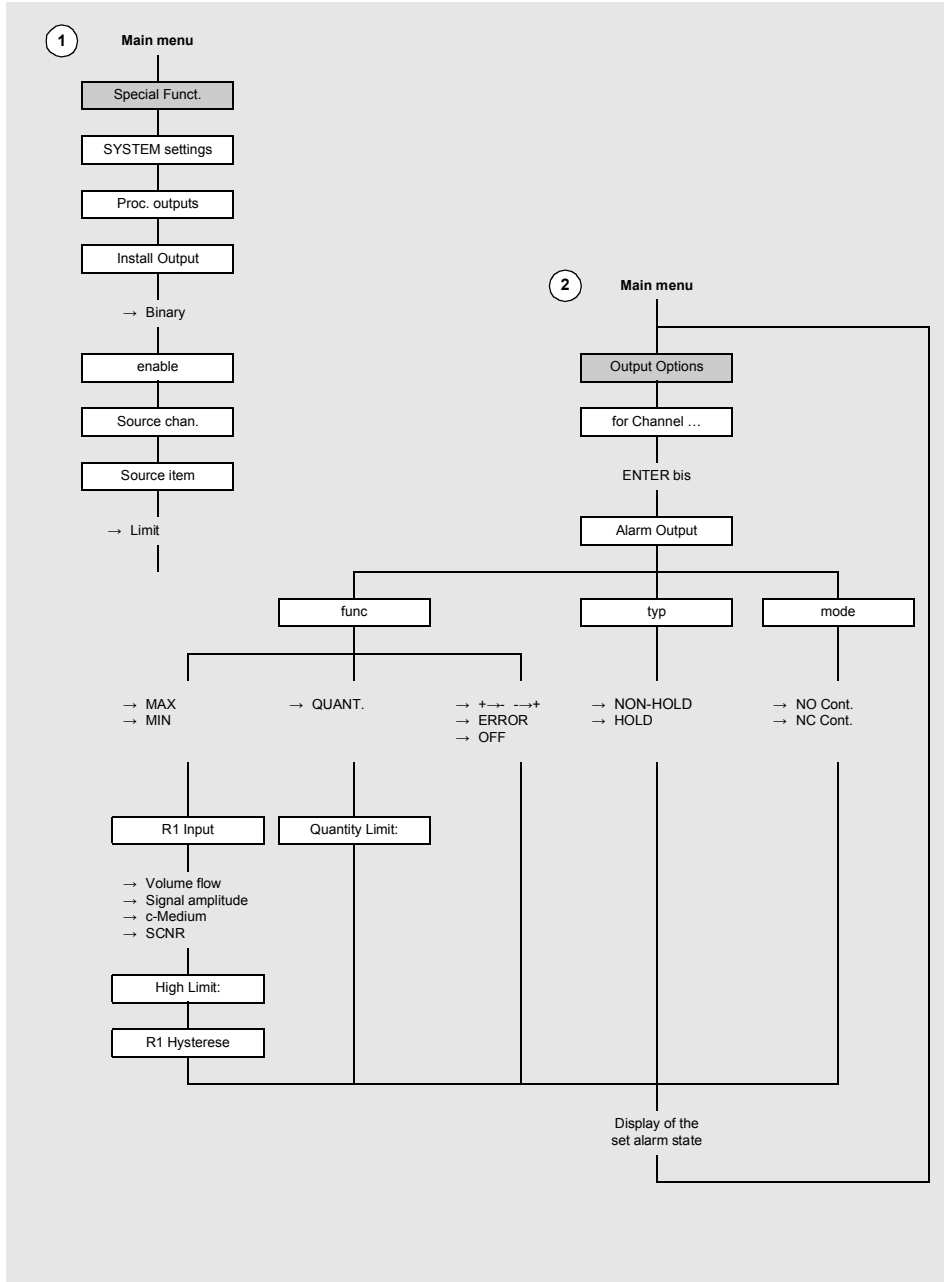

B Units of measurement

Length/roughness

unit of measurement	description
mm	millimeter
inch	inch

Temperature

unit of measurement	description
°C	degree Celsius
°F	degree Fahrenheit

Pressure

unit of measurement	description
bar(a)	bar (absolute)
bar(g)	bar (relative)
psi(a)	pound per square inch (absolute)
psi(g)	pound per square inch (relative)

Density

unit of measurement	description
g/cm ³	gram per cubic centimeter
kg/cm ³	kilogram per cubic centimeter

Sound speed

unit of measurement	description
m/s	meter per second

Kinematic viscosity

unit of measurement	description
mm ² /s	square millimeter per second

1 mm²/s = 1 cSt

Flow velocity

unit of measurement	description
m/s	meter per second
cm/s	centimeter per second
inch/s	inch per second
fps (ft/s)	foot per second

Volumetric flow rate

unit of measurement	description	volume (totalized)
m ³ /d	cubic meter per day	m ³
m ³ /h	cubic meter per hour	m ³
m ³ /min	cubic meter per minute	m ³
m ³ /s	cubic meter per second	m ³
km ³ /h	cubic kilometer per hour	km ³
ml/min	milliliter per minute	l
l/h	liter per hour	l
l/min	liter per minute	l
l/s	liter per second	l
hl/h	hectoliter per hour	hl

(1) cft: cubic foot

(2) aft: acre foot

1 US-gal = 3.78541 l

1 UK-gal = 4.54609 l

1 bbl = US Oil ≈ 159 l

1 bbl = US Wine ≈ 119 l

1 bbl = US Beer ≈ 117 l

1 bbl = UK ≈ 164 l

unit of measurement	description
hl/min	hectoliter per minute
hl/s	hectoliter per second
Ml/d (megaliter/d)	megaliter per day
bbl/d	barrel per day
bbl/h	barrel per hour
bbl/m	barrel per minute
bbl/s	barrel per second
USgpd (US-gal/d)	gallon per day
USgph (US-gal/h)	gallon per hour
USgpm (US-gal/m)	gallon per minute
USgps (US-gal/s)	gallon per second
KGPM (US-Kgal/m)	kilogallon per minute
MGD (US-Mgal/d)	million gallons per day
IGPD (UK-gal/d)	gallon per day
CFD	cubic foot per day
CFH	cubic foot per hour
CFM	cubic foot per minute
CFS	cubic foot per second
MMCFD	million cubic feet per day
MMCFH	million cubic feet per hour

volume (totalized)
hl
hl
MI
bbl
bbl
bbl
bbl
gal
gal
gal
gal
kgal
Mgal
lgal
cft ⁽¹⁾
cft
cft
aft ⁽²⁾
MMCF
MMCF

⁽¹⁾ cft: cubic foot

⁽²⁾ aft: acre foot

1 US-gal = 3.78541 l

1 UK-gal = 4.54609 l

1 bbl = US Oil ≈ 159 l

1 bbl = US Wine ≈ 119 l

1 bbl = US Beer ≈ 117 l

1 bbl = UK ≈ 164 l

Thermal energy rate

unit of measurement	description	thermal energy (totalized)
W	watt	Wh or J ⁽¹⁾
kW	kilowatt	kWh or kJ ⁽¹⁾
MW	megawatt	MWh or MJ ⁽¹⁾
GW	gigawatt	GWh or GJ ⁽¹⁾
kBTU/minute	kBTU per minute	kBT
kBTU/hour	kBTU per hour	kBT
MBTU/hour	MBTU per hour	MBT
MBTU/day	MBTU per day	MBT
TON (TH)	TON, totals in TONhours	TH
TON (TD)	TON, totals in TONdays	TD
kTON (kTH)	kTON, totals in kTONhours	kTH
kTON (kTD)	kTON, totals in kTONdays	kTD

BTU: British Thermal Unit

1 W = 1 J/s

= (1/1055.05585262) BTU/s

TON: ton of refrigeration

1 W = 1 J/s = (1/3516.852842) TON

1 TON = 200 BTU/min

⁽¹⁾ selection in Special
Funct. \SYSTEM
settings\
Measuring

Mass flow rate

unit of measurement	description
t/h	ton per hour
t/d	ton per day
kg/h	kilogram per hour
kg/min	kilogram per minute
kg/s	kilogram per second
g/s	gram per second
lb/d	pound per day
lb/h	pound per hour
lb/m	pound per minute
lb/s	pound per second
klb/h	kilopound per hour
klb/m	kilopound per minute

mass (totalized)
t
t
kg
kg
kg
g
lb
lb
lb
lb
klb
klb

1 lb = 453.59237 g

1 t = 1000 kg

C Reference

The following tables provide assistance for the user. The accuracy of the data depends on the composition, temperature and processing of the material. FLEXIM does not assume liability for any inaccuracies.

C.1 Sound speed of selected pipe and lining materials at 20 °C

The values of some of these materials are stored in the internal database of the transmitter. Column c_{flow} shows the sound speed (longitudinal or transversal) used for the flow measurement.

material (display)	explanation	c_{trans} [m/s]	c_{long} [m/s]	c_{flow}
Carbon Steel	steel, normal	3230	5930	trans
Stainless Steel	steel, stainless	3100	5790	trans
DUPLEX	duplex stainless steel	3272	5720	trans
Ductile Iron	ductile iron	2650	-	trans
Asbestos Cement	asbestos cement	2200	-	trans
Titanium	titanium	3067	5955	trans
Copper	copper	2260	4700	trans
Aluminium	aluminum	3100	6300	trans
Brass	brass	2100	4300	trans
Plastic	plastic	1120	2000	long
GRP	glass reinforced plastic (GRP)	-	2650	long
PVC	polyvinyl chloride	-	2395	long
PE	polyethylene	540	1950	long
PP	polypropylene	2600	2550	trans
Bitumen	bitumen	2500	-	trans
Acrylic	acrylic glass	1250	2730	long
Lead	lead	700	2200	long
Cu-Ni-Fe	copper-nickel-iron alloy	2510	4900	trans
Grey Cast Iron	gray cast iron	2200	4600	trans
Rubber	rubber	1900	2400	trans

material (display)	explanation	c_{trans} [m/s]	c_{long} [m/s]	C_{flow}
Glass	glass	3400	5600	trans
PFA	perfluoralcoxy	500	1185	long
PVDF	polyvinylidene fluorid	760	2050	long
Sintimid	Sintimid	-	2472	long
Teka PEEK	Teka PEEK	-	2534	long
Tekason	Tekason	-	2230	long

The sound speed depends on the composition and the manufacturing process of the material. The sound speed of alloys and cast materials fluctuates strongly. The values only serve as an orientation.

C.2 Typical roughness values of pipes

The values are based on experience and measurements.

material	absolute roughness [mm]
drawn pipes of non-ferrous metal, glass, plastics and light metal	0...0.0015
drawn steel pipes	0.01...0.05
fine-planed, polished surface	max. 0.01
planed surface	0.01...0.04
rough-planed surface	0.05...0.1
welded steel pipes, new	0.05...0.1
after long use, cleaned	0.15...0.2
moderately rusted, slightly encrusted	max. 0.4
heavily encrusted	max. 3
cast iron pipes:	
bitumen lining	> 0.12
new, without lining	0.25...1
rusted	1...1.5
encrusted	1.5...3

C.3 Typical properties of selected fluids at 20 °C and 1 bar

fluid (display)	explanation	sound speed [m/s]	kinematic viscosity [mm ² /s]	density [g/cm ³]
Aceton	acetone	1190	0.4	0.7300
Ammonia(NH3)	ammonia (NH ₃)	1386	0.2	0.6130
Gasoline	gasoline	1295	0.7	0.8800
Beer	beer	1482	1.0	0.9980
BP Transcal LT	BP Transcal LT	1365	20.1	0.8760
BP Transcal N	BP Transcal N	1365	94.3	0.8760
Diesel	diesel	1210	7.1	0.8260
Std. natural gas	natural gas, standard composition	433	12.42	0.0010
Ethanol	ethanol	1402	1.5	0.7950
HF acid 50%	hydrofluoric acid 50 %	1221	1.0	0.9980
HF acid 80%	hydrofluoric acid 80 %	777	1.0	0.9980
Glycol	glycol	1665	18.6	1.1100
20% Glycol / H2O	glycol/H ₂ O, 20 %	1655	1.7	1.0280
30% Glycol / H2O	glycol/H ₂ O, 30 %	1672	2.2	1.0440
40% Glycol / H2O	glycol/H ₂ O, 40 %	1688	3.3	1.0600
50% Glycol / H2O	glycol/H ₂ O, 50 %	1705	4.1	1.0750
ISO VG 100	ISO VG 100	1487	314.2	0.8690
ISO VG 150	ISO VG 150	1487	539.0	0.8690
ISO VG 22	ISO VG 22	1487	50.2	0.8690
ISO VG 220	ISO VG 220	1487	811.1	0.8690
ISO VG 32	ISO VG 32	1487	78.0	0.8690
ISO VG 46	ISO VG 46	1487	126.7	0.8730
ISO VG 68	ISO VG 68	1487	201.8	0.8750
Methanol	methanol	1119	0.7	0.7930

fluid (display)	explanation	sound speed [m/s]	kinematic viscosity [mm ² /s]	density [g/cm ³]
Milk	milk	1482	5.0	1.0000
Mobiltherm 594	Mobiltherm 594	1365	7.5	0.8730
Mobiltherm 603	Mobiltherm 603	1365	55.2	0.8590
caustic soda 10%	soda lye, 10 %	1762	2.5	1.1140
caustic soda 20%	soda lye, 20 %	2061	4.5	1.2230
Paraffin 248	Paraffin 248	1468	195.1	0.8450
R134 Freon	R134 Freon	522	0.2	1.2400
R22 Freon	R22 Freon	558	0.1	1.2130
Crudeoil hi-API	crude oil, light	1163	14.0	0.8130
Crudeoil low API	crude oil, heavy	1370	639.5	0.9220
30% H2SO4	sulfuric acid, 30 %	1526	1.4	1.1770
80% H2SO4	sulfuric acid, 80 %	1538	13.0	1.7950
96% H2SO4	sulfuric acid, 96 %	1366	11.5	1.8350
Juice	juice	1482	1.0	0.9980
HCl 25%	hydrochloric acid, 25 %	1504	1.0	1.1180
HCl 37%	hydrochloric acid, 37 %	1511	1.0	1.1880
Seawater	seawater	1522	1.0	1.0240
Shell Thermia B	Shell Thermia B	1365	89.3	0.8630
Silicon oil	silicone oil	1019	14 746.6	0.9660
SKYDROL 500-B4	SKYDROL 500-B4	1387	21.9	1.0570
SKYDROL 500-LD4	SKYDROL 500-LD4	1387	21.9	1.0570
Water	water	1482	1.0	0.9990

C.4 Properties of water at 1 bar and at saturation pressure

fluid temperature [°C]	fluid pressure [bar]	sound speed [m/s]	density [kg/m ³]	specific heat capacity ¹ [kJ/kg/K ⁻¹]
0.1	1,013	1402.9	999.8	4,219
10	1,013	1447.3	999.7	4,195
20	1,013	1482.3	998.2	4,184
30	1,013	1509.2	995.6	4,180
40	1,013	1528.9	992.2	4,179
50	1,013	1542.6	988.0	4,181
60	1,013	1551.0	983.2	4,185
70	1,013	1554.7	977.8	4,190
80	1,013	1554.4	971.8	4,197
90	1,013	1550.5	965.3	4,205
100	1,013	1543.2	958.3	4,216
120	1,985	1519.9	943.1	4,244
140	3,615	1486.2	926.1	4,283
160	6,182	1443.2	907.4	4,335
180	10.03	1391.7	887.0	4,405
200	15.55	1332.1	864.7	4,496
220	23.20	1264.5	840.2	4,615
240	33.47	1189.0	813.4	4,772
260	46.92	1105.3	783.6	4,986
280	64.17	1012.6	750.3	5,289
300	85.88	909.40	712.1	5,750
320	112.8	793.16	667.1	6,537
340	146.0	658.27	610.7	8,208
360	186.7	479.74	527.6	15.00
373,946	220,640	72,356	322.0	∞

¹ at constant pressure

D Conformity declarations

EU declaration of conformity according to low voltage directive

FLEXIM Flexible Industriemesstechnik GmbH

Boxberger Straße 4
12681 Berlin
Germany

declares as manufacturer under its sole responsibility that the ultrasonic flowmeter(s)

FLUXUS a601

a = F, G

complies/comply with the relevant EU regulations and directives, including any amendments valid at the time this declaration was signed. This declaration of conformity is based on the following harmonized EU standards:

EU directive 2014/35/EU (low voltage directive) relating to the making available on the market of electrical equipment designed for use within certain voltage limits

- | | |
|---------------------|--|
| EN 61010-1:2010 | Safety requirements for electrical equipment for measurement, control, and laboratory use – Part 1: General requirements |
| EN 61010-2-030:2010 | Safety requirements for electrical equipment for measurement, control, and laboratory use – Part 2-030: Particular requirements for testing and measuring circuits |

EU directive 2014/30/EU (EMC directive) relating to electromagnetic compatibility

- | | |
|-----------------------|---|
| EN 61326-1:2013 | Electrical equipment for measurement, control, and laboratory use – EMC requirements – Part 1: General requirements |
| EN 61326-2-5:2013 | Electrical equipment for measurement, control and laboratory use – EMC requirements – Part 2-3: Particular requirements – Test configuration, operational conditions and performance criteria for transducers with integrated or remote signal conditioning |
| EN 61326-2-5:2013 | Electrical equipment for measurement, control and laboratory use – EMC requirements – Part 2-5: Particular requirements – Test configurations, operational conditions and performance criteria for field devices with field bus interfaces according to IEC 61784-1 |
| EN 55011:2009/A1:2010 | Industrial, scientific and medical equipment – Radio-frequency disturbance characteristics – Limits and methods of measurement |

EU directive 2011/65/EU (RoHS directive) on the restriction of the use of certain hazardous substances in electrical and electronic equipment

- | | |
|---------------|--|
| EN 50581:2012 | Technical documentation for the assessment of electrical and electronic products with respect to the restriction of hazardous substances |
|---------------|--|

FLEXIM GmbH

Berlin, 2020-01-25

Signed for and on behalf of

Place and date



Jens Hilpert
Managing Director