

Fisher™ easy-Drive™ RPU-100

Contents

- Introduction 1
 - Scope of Manual 1
 - Description 1
 - Educational Services 2
 - Related Documents 2
- Product Operation 3
- Product Interfaces 3
 - Enable / Disable Switch 3
 - LED Key 4
- easy-Drive User Interface 5
 - Loss Detect 5
 - Status Output 5
- Installation 6
 - Product Security 6
 - Mounting 7
 - Wiring 10
- Replacement 15
 - Removal 15
 - Installation 15
- Parts Ordering 15
- Appendix A - Modbus 16
- Appendix B - Certificate of Conformance 20

Figure 1. Fisher easy-Drive RPU-100



X1718

Introduction

Scope of Manual



This instruction manual provides product information including installation for the Fisher easy-Drive RPU-100. For Fisher easy-Drive actuators refer to the appropriate easy-Drive actuator instruction manual. To avoid personal injury or property damage, it is important to carefully read, understand, and follow all the contents of this manual, including all safety cautions and warnings. If you have any questions about these instructions, contact your [Emerson sales office](#) before proceeding.

Description

The easy-Drive RPU-100 is a reserve power unit designed to provide backup power to the easy-Drive actuator upon loss of incoming power. The RPU-100 provides enough power to the actuator to allow the actuator to drive the valve to the pre-defined loss of power or loss of signal position. The RPU-100 can be ordered with a new easy-Drive assembly or be retrofit into existing easy-Drive units that have the Gen2 control board.

Table 1. Specifications

<p>Material Temperature Capabilities -40°C (40°F) to 70°C (158°F)</p> <p>Power Requirements 11-30 VDC, minimum 4 amp power supply required (fuse to 5 amps)</p> <p>Maximum Current Draw 4 amps</p> <p>Idle Current Draw 30 mA at 24 VDC, 50 mA at 12 VDC</p>	<p>Hazardous Area Approvals</p> <p>CSA (C/US): Explosion-Proof Class I, Division 1, Groups C and D, T6, Ex db IIB T6, Class I, Zone 1, AEx db IIB T6</p> <p>ATEX Flameproof - Gas:  II 2 G, Ex db IIB T6 Gb</p> <p>IECEx Flameproof - Gas: Ex db IIB T6 Gb</p> <p>Approximate Weight: 0.5 kg (1 lb)</p>
--	---

Educational Services

Emerson Educational Services
 Phone: 1-800-338-8158
 E-mail: education@emerson.com
emerson.com/mytraining

Related Documents

This section lists other documents containing information related to the easy-Drive RPU-100. These documents include:

- Fisher easy-Drive 200L Instruction Manual ([D104331X012](#))
- Fisher easy-Drive 200R Instruction Manual ([D104742X012](#))
- Fisher D3 Valve with Gen 2 easy-Drive Actuator Instruction Manual ([D104161X012](#))
- Fisher D4 Valve with Gen 2 easy-Drive Actuator Instruction Manual ([D104188X012](#))

Product Operation

The easy-Drive RPU-100 will begin charging once valid power ($\geq 11\text{VDC}$) is received. Once the RPU-100 is charged, it will pass power through to the easy-Drive actuator. Upon loss of power the RPU-100 will interrupt the control signals commanding the actuator to move to the defined loss of power/signal position. The RPU-100 will provide power to the actuator for 120 seconds to ensure enough time to complete move and then power down.

The easy-Drive RPU-100 will determine when it is sufficiently charged. Charge time will depend on the application and/or power used to perform a back up. A minimum charge time is enforced.

Product Interfaces

Enable / Disable Switch

The switch enables or disables the functionality of the RPU. When the switch is in the “disable” position the RPU-100 will continue to pass line power through to the actuator and charge but will not provide backup capability upon loss of power.



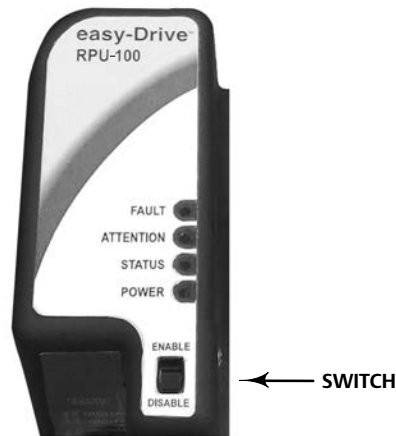







Figure 2. Fisher easy-Drive RPU-100 Switch





X1726

LED Key

Figure 3. States of the Fisher easy-Drive RPU-100

	Power (Green)	Status (Blue)	Attention (Yellow)	Fault (Red)
Normal Operation				
Charging				
Providing Power				
Disabled				
Recoverable Fault				
Non-Recoverable Fault				

 INDICATES FLASHING LIGHT  INDICATES SOLID LIGHT

easy-Drive User Interface

The easy-Drive configurator is available on the Emerson [easy-Drive](https://www.emerson.com/easy-Drive) product website or [Fisher.com](https://www.fisher.com).

Figure 4. Fisher easy-Drive Configuration Software

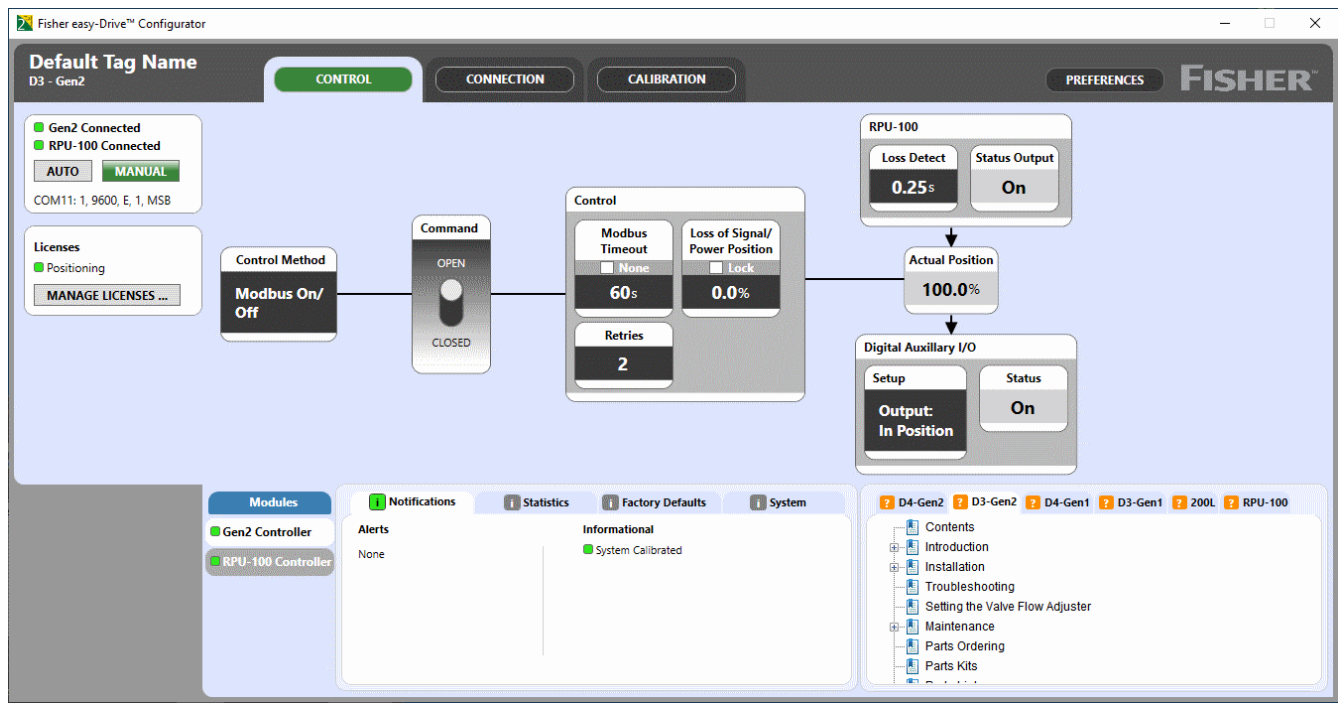

Loss Detect

The loss detect is a user defined time the RPU-100 will wait to verify loss of power before performing a backup operation. This time is configurable between 0.05 and 3.00 seconds. The default is 0.250 seconds.

Status Output

The status output is a discrete output that indicates the overall status of the RPU-100. If the output is on, (connection made) this indicates the RPU-100 is operational. If the output is off, additional information can be found in the Modbus diagnostic fault flags register.

See the Mounting section of this manual for wiring details.

Installation

⚠ WARNING

Avoid personal injury from sudden release of process pressure or bursting of parts. Before performing any maintenance operations:

- Do not remove the actuator from the valve while the valve is still pressurized.
- Always wear protective gloves, clothing, and eyewear when performing any maintenance operations to avoid personal injury.
- For linear actuator, back plug away from seat to relieve spring compression.
- Disconnect any operating lines providing air pressure, electric power, or a control signal to the actuator. Be sure the actuator cannot suddenly open or close the valve. If an RPU-100 is already installed, move the switch to the disable position to prevent movement of the valve by the RPU-100.
- Use bypass valves or completely shut off the process to isolate the valve from process pressure. Relieve process pressure on both sides of the valve. Drain the process media from both sides of the valve.
- Use lock-out procedures to be sure that the above measures stay in effect while you work on the equipment.
- Check with your process or safety engineer for any additional measures that must be taken to protect against process media.

⚠ WARNING

- For explosion-proof applications, ensure the actuator cover is properly bolted before applying power to the actuator. Personal injury or property damage may result from fire or explosion if power is applied to the actuator with the cover removed in a hazardous area.
- For explosion-proof applications, install rigid metal conduit and a conduit seal no more than 457 mm (18 in) from the actuator. Personal injury or property damage may result from explosion if the seal is not installed.
- Select wiring and/or cable glands that are rated for the environment of use (such as hazardous area, ingress protection, and temperature). Failure to use properly rated wiring and/or cable glands can result in personal injury or property damage from fire or explosion.
- Wiring connections must be in accordance with local, regional, and national codes for any given hazardous area approval. Failure to follow the local, regional, and national codes could result in personal injury or property damage from fire or explosion.
- To avoid exposure hazard or release of toxic gases, DO NOT disassemble, subject to heat above 100°C (212°F), or incinerate the RPU-100.

Note

End user must ensure a power supply voltage of 11-30VDC after retrofitting an easy-Drive electric actuator with the RPU-100 to maintain the actuator's CSA hazardous area approval.

Product Security

It is the end-user's responsibility to provide a secure facility with limits to operating equipment.

Facility cyber security practices should include keeping the Fisher easy-Drive Configurator up to date.

Mounting

The RPU-100 is mounted using the motor/gearbox bolts and the provided mounting bracket.

Figure 5. Fisher easy-Drive RPU-100 Mounting

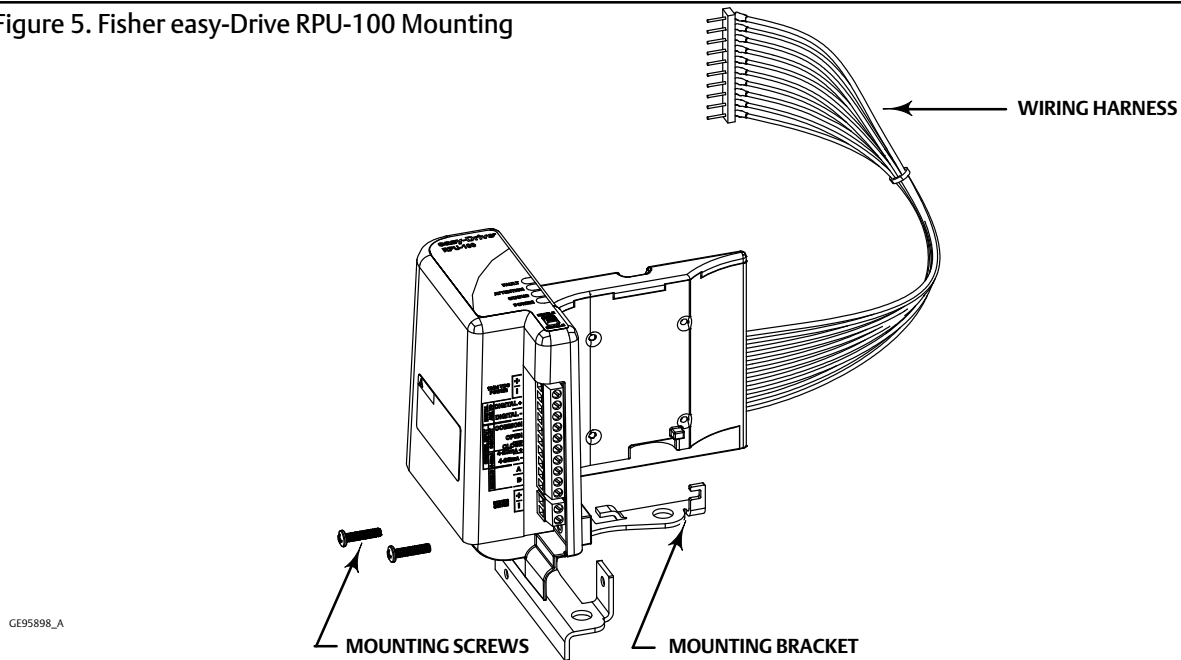

1. For linear easy-Drive — Loosen all four motor housing bolts, removing the three bolts as shown below.
 - For rotary easy-Drive — 3 mounting bolts are provided with the RPU-100 when ordered for the 200R.
2. Position the bracket on the motor/gearbox.

Figure 6.



X1723

LINEAR



X2052

ROTARY

3. For linear easy-Drive — Use the motor housing bolts removed in step one to secure the mounting bracket in place. Note the washers will not be used with the bolts with the mounting bracket.

- For rotary easy-Drive — Use the 3 mounting bolts provided to secure the mounting bracket in place.

Figure 7.

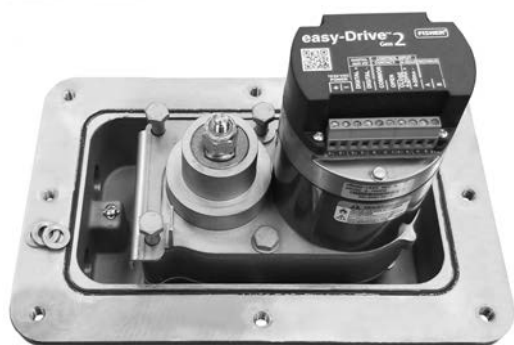

X1720

LINEAR



X2053

ROTARY

4. For linear easy-Drive — Tighten all 4 motor bolts to 15 ft • lbs (20 N • m) using a criss-cross pattern while tightening the bolts.

- For rotary easy-Drive — Tighten all 3 bolts to 15 ft • lbs (20 N • m).

5. The RPU-100 will sit down on the mounting bracket then slide toward the motor to lock into place.

Figure 8.

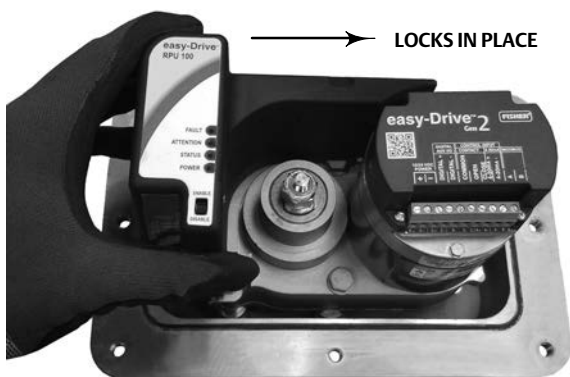

X1725

LINEAR

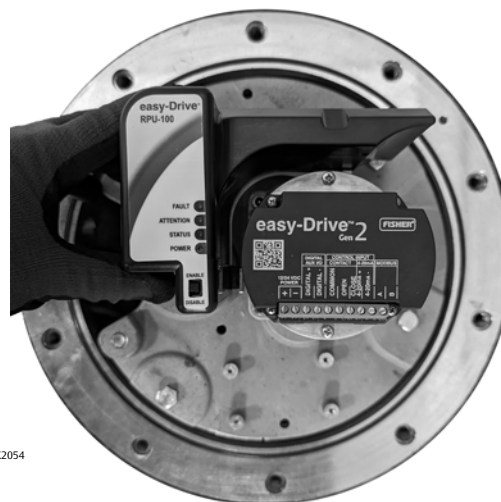

X2054

ROTARY

6. For linear and rotary easy -Drive – Once the RPU-100 is locked in place install the two mounting screws to finish securing the unit.

Figure 9.

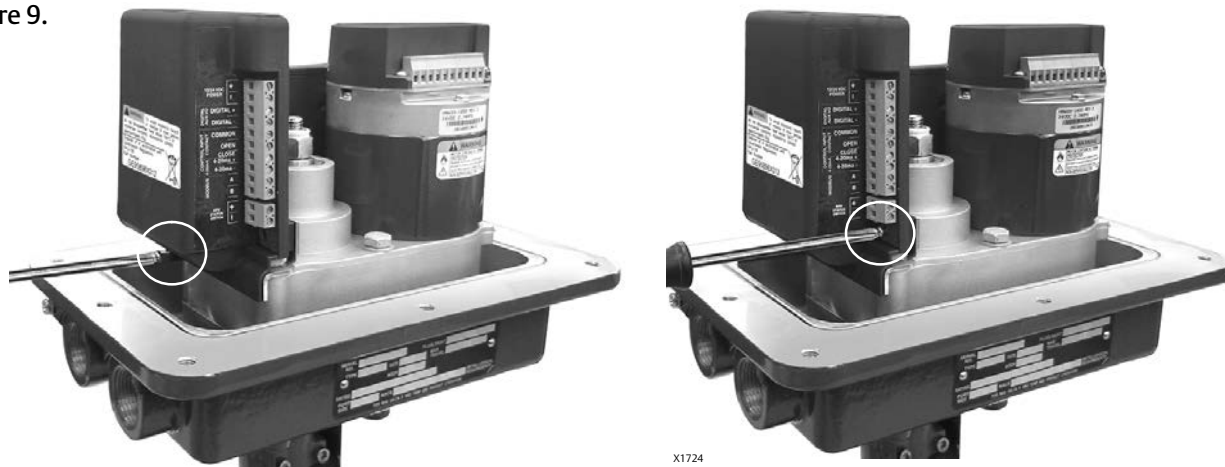

- 7. Use the provided wiring harness to connect the RPU-100 to the easy-Drive control board. Tighten all terminals to ensure solid mechanical connection. Ensure the red wire is connected to the 12/24 VDC + Power.
- 8. After wiring connections have been completed, install easy-Drive actuator upper enclosure per the applicable actuator instruction manual.
- 9. Use the easy-Drive configurator to configure the RPU-100 after installation.

Figure 10.

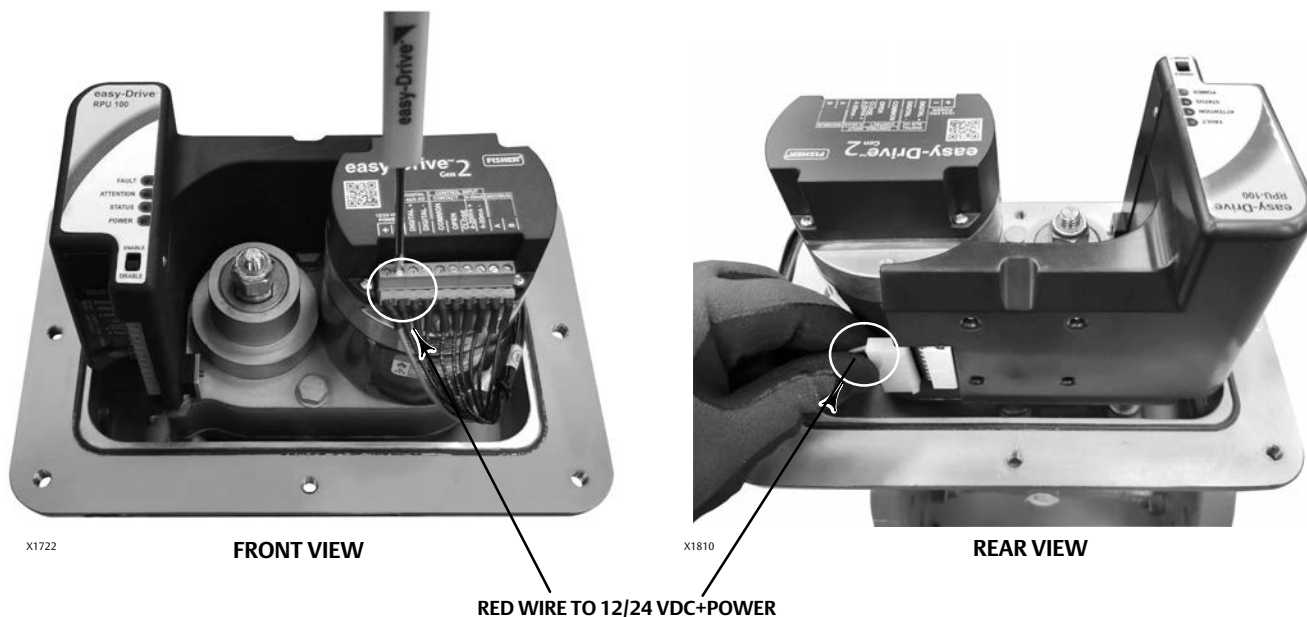

Wiring

Power Requirements

Ensure a stable DC power source is available, maintaining less than 5% ripple and sufficiently surge protected for the application. A 4 amp (minimum) power supply is required.

Wiring Instructions

1. Ensure power is turned off before connecting the wires.
2. Observe local wiring requirements for hazardous location usage.
3. Conduit seals within 450 mm (18 inches) of the enclosure port are required.
4. 18 AWG (0.52mm²) to 12 AWG (3.31mm²) wire size required.
5. Fuse system to 5A.
6. Connect enclosure and analog signal shields.
7. Be sure to tighten terminals sufficiently to ensure solid mechanical connection.

Figure 11. Wiring - RPU-100 Front View

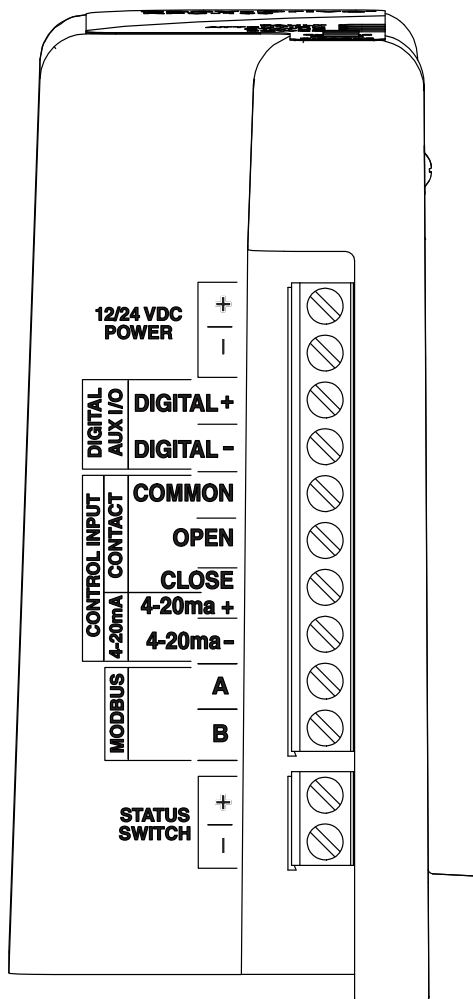

Power

- 1. Connect 12 or 24 VDC reference to: -
- 2. Connect 12 or 24 VDC positive to: +

Figure 12. Wiring - RPU-100 Input

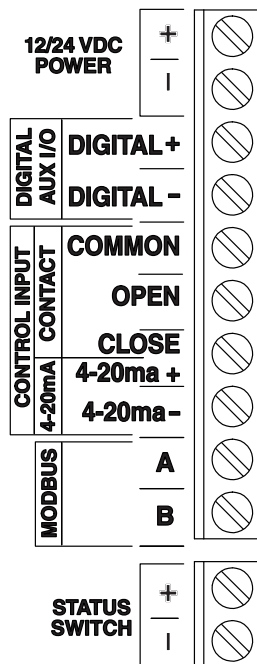

Figure 13. Wiring - Analog Input

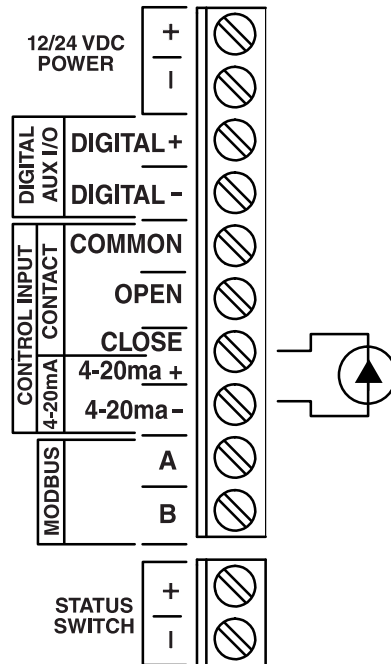

Figure 14. Wiring - Dual Dry Contact

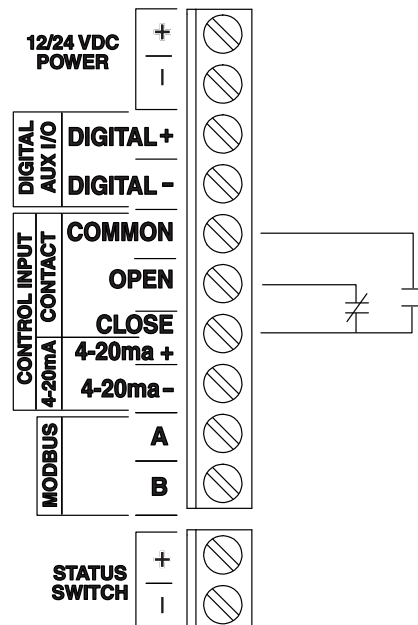

Figure 15. Wiring - Modbus Input

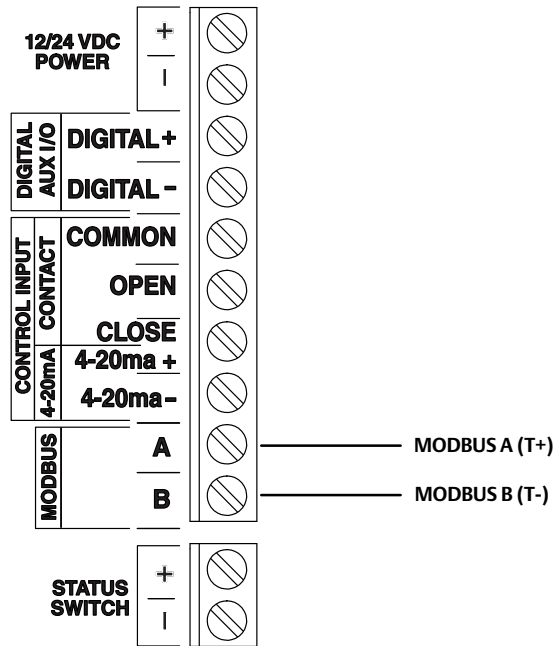

Figure 16. Wiring - Auxiliary Digital I/O

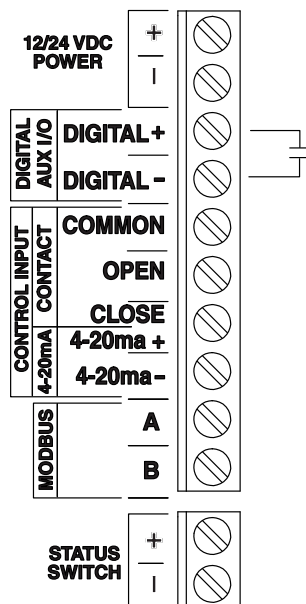

Figure 17. Wiring - Auxiliary Digital I/O

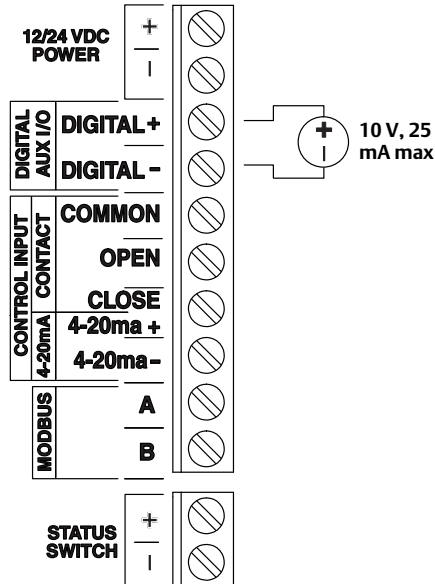
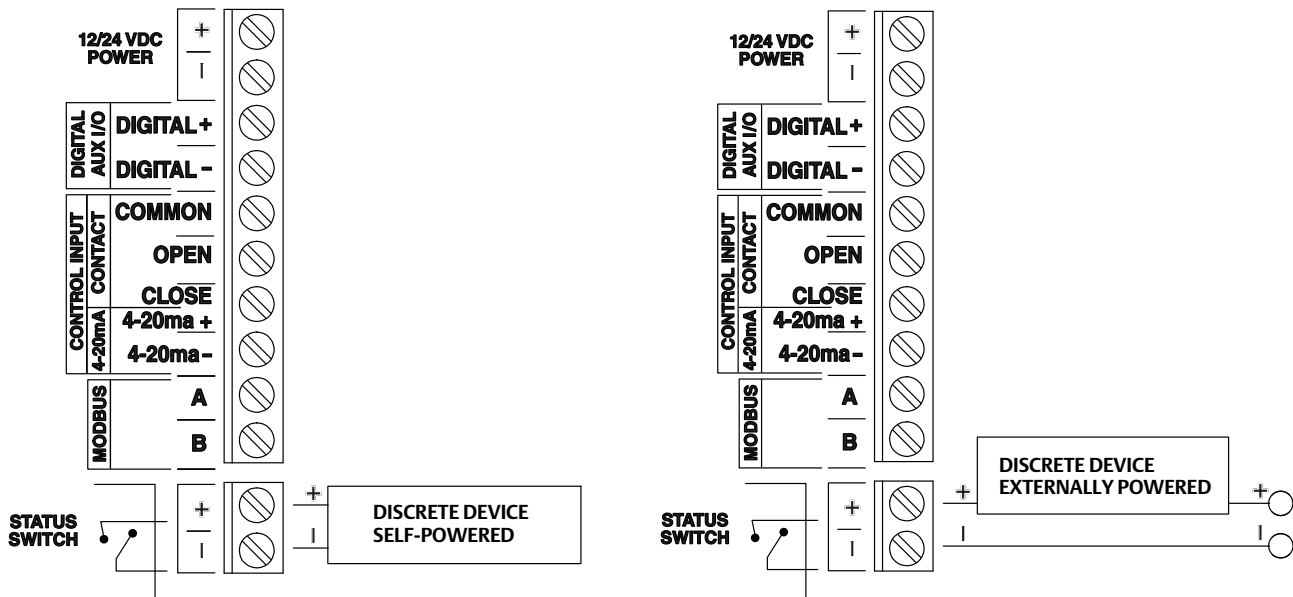

Figure 18. Wiring - RPU-100 Status Switch



Replacement

⚠ WARNING

- Refer to the **WARNINGS** at the beginning of the **Installation** section in this instruction manual.
- To avoid exposure hazard or release of toxic gases, do not disassemble, subject to heat above 100°C (212°F), or incinerate the RPU-100.

Note

Proper disposal of used reserve power unit, which contains acetonitrile, is required. Disposal should be done in accordance with applicable federal, state, and local rules and regulations.

Removal

Refer to figures 5 through 10.

1. Remove the easy-Drive actuator upper enclosure per the applicable actuator instruction manual.
2. Disable RPU-100 by moving switch on reserve power unit to 'disable' position.
3. Disconnect power from the RPU-100.
4. Disconnect wiring harness from the RPU-100.
5. Remove the two mounting screws securing the RPU-100 to the actuator.
6. Slide RPU-100 to remove from mounting bracket.

Installation

Refer to Mounting section, steps 5 through 9, for installation of new RPU-100 reserve power unit. The existing wiring harness can be used to connect to the new RPU-100.

Parts Ordering

The RPU-100 can be ordered as a part to be installed into existing easy-Drive electric actuators. Contact your [Emerson sales office](#) for assistance or when ordering replacement parts.

⚠ WARNING

Use only genuine Fisher replacement parts. Components that are not supplied by Emerson should not, under any circumstances, be used in any Fisher actuator, because they may void your warranty, might adversely affect the performance of the actuator, and could cause personal injury and property damage.

Appendix A - Modbus

A.1 Register Summary

Table 2. easy-Drive RPU-100 Modbus Map

Type	Name	MB Register	Default	R/W	Values	Notes
uint16	RESERVED	44001				
uint16	RESERVED	44002				
uint16	RESERVED	44003				
uint16	RESERVED	44004				
uint16	RESERVED	44005				
uint16	RESERVED	44006				
uint16	RESERVED	44007				
uint16	RESERVED	44008				
uint16	Clear Diagnostic Flags	44009	0	R/W	0 - 1	Value of 1 will clear diagnostic flags register. This register will automatically return to 0 after flags are cleared.
uint16	Diagnostic Flags	44010	0	R	0 - 65535	Bit flags - see chart
uint16	Digital Output Status	44011	0	R	0 - 1	0=no connection between terminals, 1=connection between terminals (Status of digital input or output)
uint32	Total Running Time	44012, 44013	0	R	0 - 4,294,967,295	Total number of minutes the RPU has been powered on since time has been reset.
uint32	Number of Power Cycles	44014, 44015	0	R	0 - 4,294,967,295	Total number of times since reset the RPU has dropped below the power loss threshold and recovered.
uint32	Number of Backup Operations	44016, 44017	0	R	0 - 4,294,967,295	Total number of backup operations the RPU has performed since reset.
uint16	Line Voltage	44018	0	R	0-3500	Value of incoming voltage with 2 implied decimal. (0.00 - 35.00 V)
uint16	RESERVED	44019				
uint16	RESERVED	44020				
uint16	RESERVED	44021				
uint16	RESERVED	44022				
uint16	RESERVED	44023				
uint16	RESERVED	44024				
uint16	RESERVED	44025				
uint16	RESERVED	44026				
uint16	RESERVED	44027				
uint16	RESERVED	44028				
uint16	RESERVED	44029				
uint16	RESERVED	44030				
uint16	RESERVED	44031				
uint16	RESERVED	44032				
uint16	RESERVED	44033				
uint16	RESERVED	44034				
uint16	RESERVED	44035				
uint16	RESERVED	44036				
uint16	Test Register - 16 bit	44037	45964	R	45964	Fixed register to test correct reading of 16 bit registers - Hex=B38C, Binary=1011001110001100
uint32	Test Register - 32 bit	44038, 44039	3,012,341,331	R	3,012,341,331	Fixed register to test correct reading of 32 bit registers - Hex=B38C AE53, Binary=1011001110001100 1010111001010011
uint16	RESERVED	44040				

-continued-

Table 2. easy-Drive RPU-100 Modbus Map (cont.)

Type	Name	MB Register	Default	R/W	Values	Notes
uint16	Loss of Power Detection Timeout	44041	250	R/W	50 - 3000	The amount of time that power is lost before the RPU makes the decision power is truly lost and takes action. Time is in milliseconds.
uint16	RESERVED	44042				
uint16	RESERVED	44043				
uint16	RESERVED	44044				
uint16	RESERVED	44045				
uint16	RESERVED	44046				
uint16	RESERVED	44047				
uint16	RESERVED	44048				
uint16	RESERVED	44049				
uint16	RESERVED	44050				
uint16	RESERVED	44051				
uint16	RESERVED	44052				
uint16	RESERVED	44053				
uint16	RESERVED	44054				
uint16	RESERVED	44055				
uint16	RESERVED	44056				
uint16	RESERVED	44057				
uint16	RESERVED	44058				
uint16	RESERVED	44059				
uint16	RESERVED	44060				
uint16	RESERVED	44061				
uint16	RESERVED	44062				
uint16	RESERVED	44063				
uint16	RESERVED	44064				
uint16	RESERVED	44065				
uint16	RESERVED	44066				
uint16	RESERVED	44067				
uint16	RESERVED	44068				
uint16	RESERVED	44069				
uint16	RESERVED	44070				
uint16	Modbus address	44071	1	R/W	1-247	Slave address of the actuator
uint16	Baud Rate	44072	5	R/W	4 - 7	4=4800 baud, 5=9600 baud, 6=19200 baud, 7=38400 baud
uint16	Parity	44073	0	R/W	0 - 2	0=Even, 1=Odd, 2=None
uint16	Modbus stop bits	44074	1	R/W	1 - 2	1 will be the standard with even and odd parity while 2 is the standard for none.
uint16	MSB/LSB	44075	0	R/W	0 - 1	0=MSB, 1=LSB
uint16	RESERVED	44076				
uc10	Device Tag	44077 - 44096	"Default Tag Name"	R/W	0 - 255 per character	Device Tag (40 byte UTF8 string)
uint16	RESERVED	44097				
uint16	RESERVED	44098				
uint16	RESERVED	44099				
uint16	RESERVED	44100				
uint16	RESERVED	44101				
uint16	RESERVED	44102				
uint16	RESERVED	44103				
uint16	RESERVED	44104				
uint16	RESERVED	44105				

-continued-

Table 2. easy-Drive RPU-100 Modbus Map (cont.)

Type	Name	MB Register	Default	R/W	Values	Notes
uint16	RESERVED	44106				
uint16	RESERVED	44107				
uint16	RESERVED	44108				
uint16	RESERVED	44109				
uint16	RESERVED	44110				
uint32	PCB serial number	44111, 44112	0	R/W*	0 - 4,294,967,295	PCB serial number
uint32	PCB revision	44113, 44114	0	R/W*	0 - 4,294,967,295	PCB revision
uint16	Flash Firmware major revision	44115	0	R	0 - 65535	From flash firmware when compiled
uint16	Flash Firmware minor revision	44116	0	R	0 - 65535	From flash firmware when compiled
uint16	Flash Firmware mod revision	44117	0	R	0 - 65535	From flash firmware when compiled
uint16	Flash Firmware build revision	44118	0	R	0 - 65535	From flash firmware when compiled
uint16	Boot Firmware major revision	44119	0	R	0 - 65535	From boot firmware when compiled
uint16	Boot Firmware minor revision	44120	0	R	0 - 65535	From boot firmware when compiled
uint16	Boot Firmware mod revision	44121	0	R	0 - 65535	From boot firmware when compiled
uint16	Boot Firmware build revision	44122	0	R	0 - 65535	From boot firmware when compiled
uint32	PCB test date	44123, 44124	0	R/W*	0 - 4,294,967,295	Seconds since January 1, 2000, Board Supplier Functional Test Date
uint32	System completion date	44125, 44126	0	R/W*	0 - 4,294,967,295	Seconds since January 1, 2000, Final Assembly Test Date
uint16	RESERVED	44127				
uint16	RESERVED	44128				
uint16	RESERVED	44129				
uint16	RESERVED	44130				
uint16	RESERVED	44131				
uint16	RESERVED	44132				
uint16	RESERVED	44133				
uint16	RESERVED	44134				
uint16	RESERVED	44135				
uint16	RESERVED	44136				
uint16	RESERVED	44137				
uint16	RESERVED	44138				
uint16	RESERVED	44139				
uint16	RESERVED	44140				
uint16	RESERVED	44141				
uint16	RESERVED	44142				
uint16	RESERVED	44143				
uint16	RESERVED	44144				
uint16	RESERVED	44145				
uint16	RESERVED	44146				
uint16	RESERVED	44147				
uint16	Reset to factory defaults	44148	0	R/W	0 - 1	Value of 1 will reset all setup registers to factory defaults. Will automatically set back to 0.
uint16	Reset statistics	44149	0	R/W	0 - 1	Value of 1 will clear all statistic registers (44011 - 44017). Will automatically set back to 0.

1. uint is defined as Unsigned Integer
 uint16 – unsigned 16 bit variable, can take value 0-65535.
 uint32 – unsigned 32 bit variable, can take value 0-4294967295.
 (Reserved) – registers used for development use only.



R/W* - writable in manufacturing.
 † - 32bit register contains data that spans two registers – reads and write of data needs to be performed within the same Modbus command function to ensure coherency of data.

Table 3. Diagnostic Fault Flags

Hex Value	Bit Mask	Description	Value	Bit	Definition
0x8000	1000 0000 0000 0000	Fault in N.V. Memory – system has restored default settings	32768	15	A memory fault has occurred and the actuator has been restored to factory defaults. Contact your Emerson sales office .
0x1000	0001 0000 0000 0000	System or Watchdog fault	4096	12	The RPU-100 has experienced a fatal error and restarted. Contact your Emerson sales office.
0x0100	0000 0001 0000 0000	Fault in N.V. Memory – system unable to restore system settings	256	8	A memory fault has occurred and the actuator cannot be restored to factory defaults. Contact your Emerson sales office.
0x0800	0000 0000 1000 0000	Operating Normal	128	7	The RPU-100 is operating normally and monitoring for power loss events.
0x0040	0000 0000 0100 0000	Charging	64	6	The RPU-100 is charging.
0x0020	0000 0000 0010 0000	Providing Backup Power	32	5	Backup power is being provided to the actuator.
0x0010	0000 0000 0001 0000	Reduced Capacitance	16	4	Reduced capacitance has been detected. Contact your Emerson sales office.
0x0008	0000 0000 0000 1000	Non-functional	8	3	The RPU-100 is currently non-functional. If over current protection is also active, correct over current situation and recheck. Contact your Emerson sales office.
0x0004	0000 0000 0000 0100	Disabled	4	2	Normal operation of the RPU-100 has been disabled via the Disable Switch. Backup power will not be provided on event of power loss.
0x0001	0000 0000 0000 0001	Overcurrent Protection Active	1	0	An over current has been detected and the output of the RPU-100 has been temporarily disabled.

Appendix B - Certificate of Conformance

Linear easy-Drive



	
<h3>EU Declaration of Conformity</h3>	
We, the manufacturer,	
Emerson Fisher Controls International LLC 205 South Center Street Marshalltown, Iowa 50158 USA	
declare under our sole responsibility that the following product(s);	
Electric Actuator easy-Drive	
to which this declaration relates, is in conformity with the provisions of the following European Community Directives, including the latest amendments, as shown in the attached schedule.	
Assumption of conformity is based on the application of the harmonized standards and, when applicable or required, a European Community Notified Body certification, as shown in the attached schedule.	
	
<hr/> Bob Stahlin Vice President-Sliding Stem Valve Business Unit Marshalltown, Iowa 50158	
<hr/> 3-August-2020 Date	
European Contact Emerson Group Services SAS Rue Paul-Baudry B.P. 10150 68701 Cernay Cedex France	
EDOCS ID: FCS_55	Page 1 of 2

-continued-

Appendix B - Certificate of Conformance (cont.)

<p><u>EMC Directive – 2014/30/EU</u></p> <p>Models: All EN 61326-1:2013</p> <p><u>RoHS Directive – 2011/65/EU</u></p> <p>Declaration of Exclusion</p> <p>Models: All</p> <p>The above equipment is excluded from the scope of this directive per Article 2, Paragraph 4, part C. Therefore the equipment cannot bear the CE mark related to RoHS compliance. However, the equipment may bear the CE mark to indicate compliance with other applicable EU directives.</p> <p><u>ATEX Directive – 2014/34/EU (Applicable only if this mark  appears on the product)</u></p> <p>Certificate – SIRA12ATEX1168X – Group II Category 2 G – Flameproof easy-Drive Ex db IIA T6(Ta ≤ 70°C) Gb Standards used: EN60079-0:2012/A11:2013, EN60079-1:2014</p> <p><u>ATEX Notified Body for EC-Type Examination Certificate(s)</u> CSA Group Netherlands B.V. – Notified Body Number: 2813 Utrechtseweg 310, Building B42 6812AR Arnhem The Netherlands</p> <p><u>ATEX Notified Body for Quality Assurance</u></p> <p>SGS Fimko Oy – Notified Body Number: 0598 P.O. Box 30 (Särkiniementie 3) Helsinki, 00211 Finland</p>

Appendix B - Certificate of Conformance Rotary easy-Drive

	
EU Declaration of Conformity	
We, the manufacturer,	
Emerson Fisher Controls International LLC 205 South Center Street Marshalltown, Iowa 50158 USA	
declare under our sole responsibility that the following product(s);	
Electric Actuator easy-Drive 200R	
to which this declaration relates, is in conformity with the provisions of the following European Community Directives, including the latest amendments, as shown in the attached schedule.	
Assumption of conformity is based on the application of the harmonized standards and, when applicable or required, a European Community Notified Body certification, as shown in the attached schedule.	
	
<hr/> Michael Gotlieb Vice President-Sliding Stem Valve Business Unit Marshalltown, Iowa 50158	
<hr/> 10/23/2023 Date	
European Contact Emerson Group Services SAS Rue Paul-Baudry B.P. 10150 68701 Cernay Cedex France	
EDOCS ID: FCS_91	Page 1 of 2

-continued-

Appendix B - Certificate of Conformance (cont.)

EMC Directive – 2014/30/EU

Models: All
EN 61326-1:2013

RoHS Directive – 2011/65/EU

Declaration of Exclusion

Models: All

The above equipment is excluded from the scope of this directive per Article 2, Paragraph 4, part C. Therefore the equipment cannot bear the CE mark related to RoHS compliance. However, the equipment may bear the CE mark to indicate compliance with other applicable EU directives.

ATEX Directive – 2014/34/EU (Applicable only if this mark appears on the product)

Certificate – **CSANe 21ATEX1000X – Group II Category 2 G** – Flameproof
easy-Drive 200R
Ex db IIB T6(Ta ≤ 70°C) Gb
Standards used: EN60079-0:2018, EN60079-1:2014

ATEX Notified Body for EC-Type Examination Certificate(s)

CSA Group Netherlands B.V. – Notified Body Number: 2813
Utrechtseweg 310, Building B42
6812AR Arnhem
The Netherlands

ATEX Notified Body for Quality Assurance

SGS Fimko Oy – Notified Body Number: 0598
P.O. Box 30 (Särkiniementie 3)
Helsinki, 00211
Finland

Neither Emerson, nor any of their affiliated entities assumes responsibility for the selection, use or maintenance of any product. Responsibility for proper selection, use, and maintenance of any product remains solely with the purchaser and end user.

Fisher and easy-Drive are marks owned by one of the companies in the Emerson business unit of Emerson Electric Co., Emerson, and the Emerson logo are trademarks and service marks of Emerson Electric Co. All other marks are the property of their respective owners.

The contents of this publication are presented for informational purposes only, and while every effort has been made to ensure their accuracy, they are not to be construed as warranties or guarantees, express or implied, regarding the products or services described herein or their use or applicability. All sales are governed by our terms and conditions, which are available upon request. We reserve the right to modify or improve the designs or specifications of such products at any time without notice.

Emerson

Marshalltown, Iowa 50158 USA

Sorocaba, 18087 Brazil

Cernay, 68700 France

Dubai, United Arab Emirates

Singapore 128461 Singapore

www.Fisher.com

