

Rosemount™ 3410 Series Gas Ultrasonic Flow Meters

Model 3418



Safety and approval information

This Rosemount product complies with all applicable European directives when properly installed in accordance with the instructions in this manual. Refer to the EU Declaration of Conformity for directives that apply to this product. The EU Declaration of Conformity, with all applicable European directives, and the complete ATEX installation drawings and instructions are available on the Internet at Emerson.com or through your local Emerson support center.

Information affixed to equipment that complies with the Pressure Equipment Directive can be found on the Internet at Emerson.com.

For hazardous installations in Europe, refer to standard EN 60079-14 if national standards do not apply.

Other information

Full product specifications can be found in the product data sheet. Troubleshooting information can be found in the maintenance and troubleshooting manual.

Product data sheets and manuals are available on the Emerson website at Emerson.com.

Return policy

Follow Emerson procedures when returning equipment.

These procedures ensure legal compliance with government transportation agencies and help provide a safe working environment for Emerson employees. Emerson will not accept your returned equipment if you fail to follow Emerson procedures. Return procedures and forms are available on our website at Emerson.com or by phoning the Emerson Customer Service department.

Contents

Chapter 1	Introduction.....	5
	1.1 General overview of Rosemount gas flow meters.....	5
	1.2 Hazard messages.....	5
	1.3 Personnel qualifications.....	5
	1.4 Warranty restrictions.....	7
	1.5 Assistance.....	7
	1.6 Typical applications of this product.....	7
	1.7 Features and benefits of the 3418 meter.....	8
	1.8 Acronyms, abbreviations, and definitions.....	9
	1.9 MeterLink™ software.....	11
	1.10 Design of Rosemount 3410 series meter.....	11
	1.11 Meter specifications for Rosemount Model 3418.....	13
	1.12 Pre-installation considerations.....	19
	1.13 Safety considerations.....	20
	1.14 Certifications and approvals for the Rosemount 3410 series.....	20
	1.15 FCC compliance.....	21
	1.16 References.....	21
Chapter 2	Mechanical installation.....	23
	2.1 Meter piping, lifting and mounting.....	23
	2.2 Piping recommendations.....	25
	2.3 Pre-installation inspection.....	27
	2.4 Mounting requirements in heated or cooled pipelines.....	35
Chapter 3	Electrical installation.....	37
	3.1 Cable length TTL mode.....	37
	3.2 Cable length Open Collector mode.....	37
	3.3 Grounding meter electronics housing.....	37
	3.4 Conduit seals.....	39
	3.5 Wiring and inputs/outputs.....	44
	3.6 Security seal installation.....	64
	3.7 Sealing the unit.....	69
Chapter 4	Configuration.....	71
	4.1 Set up the MeterLink™	71
	4.2 Field Setup Wizard.....	71
	4.3 Security seals for the meter	78
	4.4 Configure users and network security.....	78
Appendix A	Engineering drawings.....	79
	A.1 Rosemount 3410 Series engineering drawings.....	79
Appendix B	Open source licenses.....	83
	B.1 List of source codes for executable files.....	83

1 Introduction

1.1 General overview of Rosemount gas flow meters

Rosemount 3410 Series Ultrasonic Gas Flow Meters have various configurations that meet a broad range of customer requirements. Each meter comes fully assembled from Emerson.

Refer to the following documents for additional details:

- 00809-0100-7630 [MeterLink™ Software for Gas and Liquid Ultrasonic Flow Meters Quick Start Manual](#)
- 00809-0700-3104 Rosemount 3410 Series Ultrasonic Gas Flow Meter Maintenance and Troubleshooting Manual

1.2 Hazard messages

This document uses the following criteria for hazard messages based on ANSI standards Z535.6-2011 (R2017).

 **DANGER**

Serious injury or death will occur if a hazardous situation is not avoided.

 **WARNING**

Serious injury or death could occur if a hazardous situation is not avoided.

 **CAUTION**

Minor or moderate injury will or could occur if a hazardous situation is not avoided.

NOTICE

Data loss, property damage, hardware damage, or software damage can occur if a situation is not avoided. There is no credible risk of physical injury.

Physical access

NOTICE

Unauthorized personnel can potentially cause significant damage and/or misconfiguration of end users' equipment. Protect against all intentional or unintentional unauthorized use. Physical security is an important part of any security program and fundamental to protecting your system. Restrict physical access to protect users' assets. This is true for all systems used within the facility.

1.3 Personnel qualifications

Read and follow all instructions, dangers, warnings, and cautions to avoid personal injury or property damage during system operation.

Emerson is not responsible for damage or injury resulting from unsafe use of products, lack of maintenance, incorrect installation of equipment, or incorrect system operation. If

in doubt about any applications and safety precautions described in this document, contact Emerson.

Inform and train all personnel in the proper installation, operation, and maintenance of this product. To ensure safe and proper performance, only informed and trained personnel should install, operate, repair, and maintain this product. For further questions about training requirements, contact your local Emerson representative.

Operations risk assessment must be used and followed in conjunction with this document when performing all online retrieval operations.

Ensure that all personnel read, understand, and adhere to all end user and installation specific safety requirements.

Ensure that any operator that is conducting work on the equipment is following end user guidelines on the use of personal protective equipment (PPE) including, but not limited to:

- Safety helmet or hard hat
- Steel-toed shoes
- Safety glasses
- Working gloves (suitable for mechanical operations)
- Chemical resistant latex gloves or the equivalent
- Long-sleeved, fire-retardant shirt and fire-retardant trousers or full-length fire retardant coveralls

Additional PPE may be required depending on facility requirements and Material Safety Data Sheet (MSDS) requirements, if applicable. Failure to comply may result in personnel injury.

⚠ WARNING

Risk to personnel and equipment

Failure to follow the installation, operation or maintenance instructions for a Rosemount product could lead to serious injury or death from explosion or exposure to dangerous substances.

To reduce the risk:

Comply with all information on the product, in this manual, and in any local and national codes that apply to this product.

Do not allow untrained personnel to work with this product.

Use Rosemount parts and work procedures specified in this manual.

⚠ WARNING

Observe all precautionary signs posted on the equipment to avoid serious injury.

⚠ WARNING

Risk to personnel and equipment

Operation of this product on pressurized lines may potentially imply operational risk for personnel and equipment from the potential escape of hot gas or liquid, which could result in serious injury.

Observe all precautionary signs on the equipment.

⚠ WARNING

Risk to personnel and equipment

The operation of the Rosemount product involves heavy equipment handling. Observe the following guidelines to avoid potentially serious injury:

- Be aware of your limitations and ask for assistance if needed.
- Do not attempt to lift weight beyond your capacity.
- Lift with your legs, not your back.
- Mechanical lifting tools may also be used in some locations to reduce risk.\

NOTICE

Attending the training course for this product is not considered sufficient for operating the tool on pressurized lines. Emerson requires a two-man crew with formal training. Additionally, at least one of the operators must have a record of extensive field experience and be certified for this work.

Emerson assumes no responsibility for incidents or consequences of incidents occurring as a result of the use of this product by others than Emerson or its designated personnel and has no liability whatsoever for any such work.

Consult Emerson for more details on both training and certification.

1.4 Warranty restrictions

Visually inspect all components for shipping damage. If shipping damage is found, notify the carrier at once. Shipping damage is not covered by the warranty. The carrier is responsible for all repair and replacement costs resulting from shipment damage.

1.5 Assistance

The Emerson Global Service Center is organized through a network of service centers worldwide, and supports all service requirements or technical queries.

For the Product Support Help Desk, go to: [Emerson.com](https://www.emerson.com) or contact your nearest Emerson service provider.

1.6 Typical applications of this product

Rosemount 8-path 3410 Series Ultrasonic Gas Flow Meters have various configurations that meet a broad range of customer requirements. Each meter comes fully assembled from Emerson. The technology can be applied to custody transfer, allocation measurement, and check metering applications such as:

- Custody transfer
- Production and gathering
- Offshore
- Gas processing plants
- Underground storage sites
- Transmission pipelines
- Power plants

- Large and industrial users

1.7 Features and benefits of the 3418 meter

- OIML Accuracy Class 0.5 with five diameters upstream pipe and no flow conditioner
- Best-in-class performance in compact installations
- Reduce size, weight, and capital costs of metering system designs
- Configurable read-only serial ports
- GERG-2008 and Detail AGA Methods
- Proven long term stability
- Field proven reliability
- No line obstruction
- No pressure loss
- Low maintenance
- Bi-directional measurement
- Extensive self-diagnostics
- Immediate alarm reporting
- Continuous flow analysis
 - Abnormal profile
 - Blockage
 - Internal bore buildup
 - Liquids present in the gas meter
 - Reverse flow
 - Speed of sound comparison error
- Auto-detected ASCII/RTU Modbus® communications protocol
- Low power consumption
- Sophisticated noise reduction
- Internet-ready communications
- Ethernet access
- On-board LED status indicators
- Analog pressure and temperature inputs
- API Chapter 21 compliant event and data logging (gas meters)
- MeterLink™ (a Windows®- based interface software)
- Local display (optional)
- Smart meter verification (4-Path and 8-Path meters)

For other features and benefits, refer to the [Emerson Ultrasonic flow meter product data sheets](#).

1.8 Acronyms, abbreviations, and definitions

Acronym or abbreviation	Definition
°	Degree (angle)
°C	Degrees Celsius (temperature unit)
°F	Degrees Fahrenheit (temperature unit)
ADC	Analog-to-digital converter
AI	Analog input
AO	Analog output
ASCII MODBUS	A Modbus [®] protocol message framing format in which ASCII characters are used to delineate the beginning and end of the frame. ASCII stands for American Standard Code for Information Interchange.
boolean	A type of data point that can only take on values of TRUE or FALSE (generally TRUE is represented by a value of 1, FALSE is represented by a value of 0).
bps	Bits per second (baud rate)
cPoise	Centipoise (viscosity unit)
CPU	Central processing unit
CTS	Clear-to-send; the RS-232C hand shaking signal input to a transmitter indicating that it is okay to transmit data, meaning that the corresponding receiver is ready to receive data. Generally, the request-to-send (RTS) output from a receiver is input to the clear-to-send (CTS) input of a transmitter.
DAC	Digital-to-analog converter
MeterLink [™]	Ultrasonic meter interface software
DI	Digital input
DO	Digital output
DHCP	Dynamic host configuration protocol
dm	Decimeter (10 ⁻¹ meters, length unit)
ECC	Error correction code
EEPROM	Electrically-erasable, programmable read-only memory
Flash	Non-volatile, programmable read-only memory
FODO	Output that is user configurable as either a frequency or digital output
HART [®] Communication Protocol	Highway addressable remote transducer communications protocol
hr	Hour (time unit)
Hz	Hertz (cycles per second, frequency unit)
I/O	Input/output
IS	Intrinsically safe
K	Kelvin (temperature unit)

Acronym or abbreviation	Definition
kHz	kilohertz (10 ³ cycles per second, frequency unit)
LAN	Local area network
LED	Light-emitting diode
m	Meter (length unit)
m ³ /d	Cubic meters per day (volumetric flow rate)
m ³ /h	Cubic meters per hour (volumetric flow rate)
m ³ /s	Cubic meters per second (volumetric flow rate)
mA	Milliamp (current unit)
MAC address	Media access control (Ethernet hardware address - EHA)
microinch (m inch)	Microinch (10 ⁻⁶ in)
micron	Micrometer (10 ⁻⁶ m)
MMU	Memory management unit
MPa	Megapascal (equivalent to 10 ⁶ Pascal) (pressure unit)
N/A	Not applicable
Nm ³ /h	Normal cubic meters per hour
NVRAM	Non-volatile random access memory
Pa	Pascal, equivalent to 1 newton per square meter (pressure unit)
Pa × s	Pascal second (viscosity unit)
PC	Personal computer
PFC	Peripheral field connection (board)
P/N	Part number
PS	Power supply (board)
psi	Pounds per square inch (pressure unit)
psia	Pounds per square inch absolute (pressure unit)
psig	Pounds per square inch gauge (pressure unit)
R	Radius of meter
rad	Radian (angle)
RAM	Random access memory
RTS	Request-to-send; the RS-232C hand shaking signal output by a receiver when it is ready to receive data
RTU MODBUS	A Modbus [®] protocol framing format in which elapsed time between received characters is used to separate messages. RTU stands for remote terminal unit.
s	Second (time unit, metric)
SDRAM	Synchronous dynamic random access memory
sec	Second (time unit, US customary)
TCP/IP	Transmission control protocol/Internet protocol

Acronym or abbreviation	Definition
time_t	Seconds since Epoch (00:00:00 UTC Jan.1,1970) (time unit)
UDP	User datagram protocol
U.L.	Underwriters Laboratories, Inc. - product safety test in gand certification organization
V	Volts (electric potential unit)
W	Watts (power unit)

1.9 MeterLink™ software

MeterLink software has robust features for setting communications parameters, configuring your meter, collecting logs and reports and monitoring the meter health and alarm statuses. MeterLink may be downloaded at no charge from: [Emerson.com/meterlink](https://emerson.com/meterlink).

Figure 1-1: MeterLink download and registration

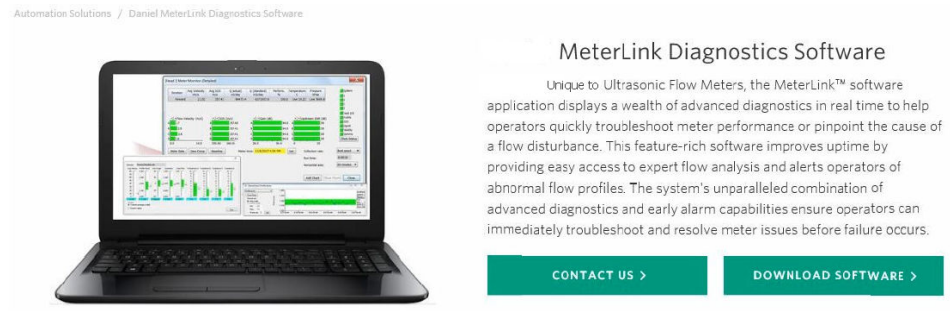

Refer to MeterLink Software for [Gas and Liquid Ultrasonic Meters Quick Start Manual](#) for installation instructions and setup for initial communications. You may download the manual from the MeterLink web page: [Emerson.com/meterlink](https://emerson.com/meterlink).

1.10 Design of Rosemount 3410 series meter

3410 Series Gas Ultrasonic Flow Meters are designed to accurately measure products in applications where reliable performance is critical, by measuring the difference in signal transit time with and against the flow across one or more measurement path(s). A signal transmitted in the flow direction travels faster than one transmitted against the flow direction. Each measurement path is defined by a transducer pair in which each transducer alternately acts as transmitter and receiver. The meter uses transit time measurements and transducer location information to calculate the mean velocity.

The 3418 combines the power of two interlocked 4-path British Gas design meters in one flow meter body. The second set of chords is the mirror image of the first, which allows the meter to cancel out the effects of swirl and cross flow. The meter offers bidirectional measurement and superior low-flow capabilities, without the compromises associated with conventional technologies.

Figure 1-2: 3418 Gas Ultrasonic Flow Meter design

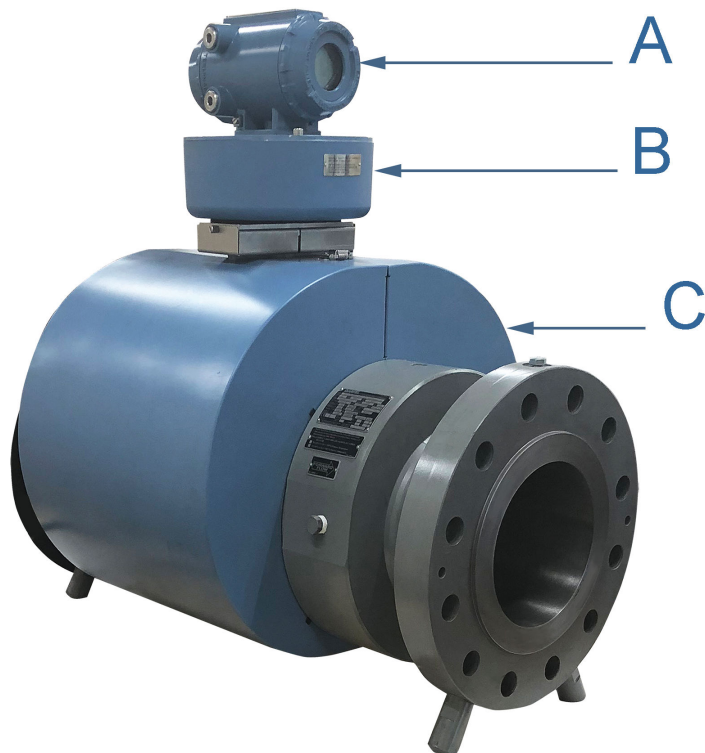

- A. Transmitter electronics enclosure (explosion-proof) Optional - Local Display with glass end cap (Figure 1-3)
- B. Base electronics enclosure (intrinsically safe)
- C. Meter body with transducer assemblies (T-21, T-22 or T-200) (intrinsically safe) covered by security shrouds

The Gas Ultrasonic Flow Meter design is available with an optional glass end cap and a local display.

Figure 1-3: Transmitter electronics enclosure with local display and glass end cap

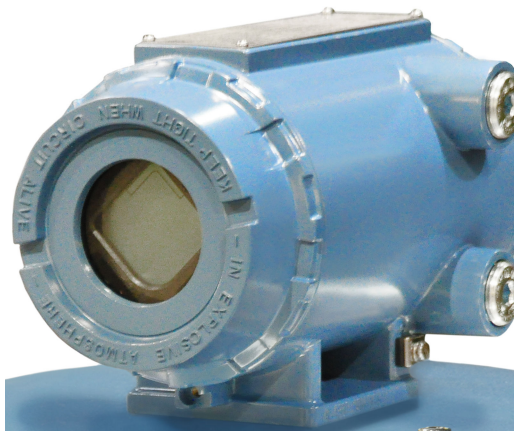

All Rosemount ultrasonic flow meters' U.L. safety listing is accomplished through the combination of an explosion-proof transmitter electronics enclosure that houses the CPU module, Power Supply board, I.S. Barrier board, Backplane board and optional LCD Display board.

Note

The optional LCD Display requires firmware v1.04 or later and Uboot version, April 25, 2022.

The Base Electronics Enclosure that houses the Acquisition Module. Intrinsically safe transducers and cable assemblies are designed for Class 1, Division1, Groups C and D areas without need of further protection when installed in accordance with the field wiring diagram (refer to Rosemount drawing DMC-005324. See [Engineering drawings](#)).

1.11 Meter specifications for Rosemount Model 3418

! WARNING

Contents may be under pressure.

When the meter is under pressure, DO NOT attempt to remove or adjust the transducer holder of the T-Slot transducer assembly or loosen the screws holding the T-200 transducer assembly.

Attempting to do so could release pressurized gases, resulting in serious injury or equipment damage.

! WARNING

Contents may be hazardous.

The meter must be fully depressurized and drained before attempting to remove the T-200 transducer assembly. If gas or fluid begins to leak from the T-200 transducer stalk assembly, stop immediately and reinstall T-200 stalk assembly.

Failure to comply could cause serious injury or equipment damage.



A. Transducer holder

 **CAUTION**

Escaping gases or fluids hazard
The purchaser of the meter is responsible for the selection of Rosemount components/seals and materials compatible with the chemical properties of gas flow measurement. Failure to select the suitable meter component/seals may cause escaping gases or liquids, resulting in injury or equipment damage.

Consult your Emerson Flow sales and service representative to ensure you purchase the correct components and seals for your application. Specifications for Gas Ultrasonic Flow Meter model 3418 are below:

Table 1-1: Model 3418 meter specifications (part 1)

3418 meter specifications	
Meter type	Number of paths <ul style="list-style-type: none"> • 3418: 8-path chordal design
	Ultrasonic type <ul style="list-style-type: none"> • Transit-time based measurement • Spool piece with integral mount transducers
Enclosure materials	<ul style="list-style-type: none"> • ASTM B26GrA356.0T6 Aluminum <ul style="list-style-type: none"> — 100% conversion coated and exterior coated with a polyurethane enamel • ASTM A351 GrCF8MStainless Steel <ul style="list-style-type: none"> — Passivated
	Optional Local Display with a glass endcap on transmitter enclosure
Meter performance	
Flow specifications	Model 3418 8-path chordal design <ul style="list-style-type: none"> • Flow calibrated accuracy is $\pm 0.1\%$ of reading over entire flow calibration range • OIML Accuracy Class 0.5 with 5 diameters upstream pipe and no flow conditioner
Repeatability	<ul style="list-style-type: none"> • $\pm 0.05\%$ of reading in the specified velocity range from 5% to 100% (Q_{max})
Velocity range	<ul style="list-style-type: none"> • Nominal 0 to 30 m/s (0 to 100 fps) with over-range performance exceeding 38 m/s (125 fp/s) on some sizes • Meter meets or exceeds AGA 9 2017 Edition / ISO 17089 performance specifications

Table 1-2: Performance specifications

Model 3418				
AGA 9 / ISO 17089 Flow rate values (Metric units)				
Meter size (DN)	250 to 600	750	900	1050
Qmin (m/s)	0.5	0.5	0.5	0.5
Qt (m/s)	3.048	2.591	2.29	CF *

Table 1-2: Performance specifications (continued)

Model 3418				
AGA 9 / ISO 17089 Flow rate values (Metric units)				
Meter size (DN)	250 to 600	750	900	1050
Qmax (m/s)	30.48	25.91	22.86	CF *

Model 3418				
AGA 9 / ISO 17089 Flow rate values (US Customary Units)				
Meter size (IN)	10 to 24	30	36	42
Qmin (ft/s)	1.7	1.7	1.7	1.7
Qt (ft/s)	10	8.5	7.5	CF *
Qmax (ft/s)	100	85	75	CF *

(*) CF = consult factory

Table 1-3: Model 3418 meter specifications (part 2)

Body and Flange Sizes and Pressure rating range	<p>U.S. Customary Units - Meter sizes 10, 12, 16, 20, 24, 30, 36 and 42 (inches)</p> <ul style="list-style-type: none"> ANSI pressure classes 300, 600, 900, 1050 and 2500 (per ANSI B16.5) Carbon Steel 316 Stainless Steel <p>Metric Units - Meter sizes DN - 250, 300, 400, 500, 600, 750, 900 and 1050</p> <ul style="list-style-type: none"> PN 50, 100, 150, 200, 420 Carbon Steel 316 Stainless Steel <p>Maximum Pressures</p> <ul style="list-style-type: none"> Dependent on operating temperature <p>Meter bore</p> <ul style="list-style-type: none"> Schedule 20, 30, 40, 60, 80, 100, 120, 140, 160, STD, XS, LW
Flanges types	ANSI classes - 300, 600, 900, 1500 and 2500 (per ANSI B16.5)
Specific gravity	0.35 to 1.50
Accuracy Limits	<p>Model 3418 is AGA 9 compliant with accuracy limits</p> <ul style="list-style-type: none"> Flow calibrated accuracy is $\pm 0.1\%$ of reading over entire flow calibration range OIML Accuracy Class 0.5 with 5 diameters upstream pipe and no flow conditioner
Minimum operating pressure	100 psig (7 barg)

Table 1-3: Model 3418 meter specifications (part 2) (continued)

Electronic specifications	
Power	<p>Meter</p> <ul style="list-style-type: none"> • 10.4 Vdc to 36 Vdc • 11 W power consumption (15 W maximum) <p>Serial cable</p> <ul style="list-style-type: none"> • Belden #9940 or equivalent (22 gauge) <ul style="list-style-type: none"> — Capacitance (pF/m) 121.397 (conductor to conductor) — Capacitance (pF/m) 219.827 (conductor to other conductor and shield) — Resistance (DC) DCR @ 20 °C (recommended) <p>Ethernet cable</p> <ul style="list-style-type: none"> • Cat-5 Standard 100 Mbps <p>Frequency (see Table 1-2)</p> <ul style="list-style-type: none"> • 22 AWG wire characteristics areas follows: <ul style="list-style-type: none"> — Capacitance = 20 pF/ft or 20 nF/1000 ft (between two wires) — Resistance = 0.0168 Ohms/ft or 16.8 Ohms/1000 ft — Pull-up voltages 24 Vdc

Table 1-4: Transducers, mounts and holders

Transducer specifications		
Transducer type	Temperature range	Mount and holder type
T-21 ¹	-4 °F to +212 °F (-20 °C to +100 °C)	Standard mounts/Holders/NBR O-ring Inconel mounts/316L Holders/NBR O-ring Inconel Mounts/Inconel Holders/FKM O-ring Inconel Mounts/316L Holders/FKM O-ring
T-22 ²	-58 °F to +212 °F (-50 °C to +100 °C)	Standard mounts/Holders/NBR O-ring Inconel mounts/316L Holders/NBR O-ring Inconel Mounts/Inconel Holders/FKM O-ring Inconel Mounts/316L Holders/FKM O-ring

Table 1-4: Transducers, mounts and holders (continued)

Transducer specifications		
Transducer type	Temperature range	Mount and holder type
T-41	-58 °F to +212 °F (-50 °C to +100 °C)	Standard mounts/Holders/NBR O-ring Inconel mounts/316L Holders/NBR O-ring Inconel Mounts/Inconel Holders/FKM O-ring Inconel Mounts/316L Holders/FKM O-ring
T-200	-58 °F to +257 °F (-50 °C to +125 °C)	Standard Stalk Assemblies Inconel Stalk Assemblies
¹ T-21 and T-41 transducers use W-01 transformers ² T-22 transducers use W-02 transformers		
Note The process temperature must not exceed the operating temperature range of the transducers.		
Note T-21 and T-41 transducers are used for the direct paths of 16" and larger meters. T-22 and T-200 transducers are used for the direct paths of 12" and smaller meters.		
Note The ultrasonic transducers are not intended for use across boundary walls of different hazardous area classifications. The transmitter electronics cannot be remote mounted from Division 1 classification to a Division 2 area to meet an area classification.		

Table 1-5: Model 3418 meter specifications (part 3)

Communications specifications	
Connectivity protocols	One serial RS-232/RS-485 port (115 kbps baud rate) (Modbus® RTU/ASCII) <ul style="list-style-type: none"> (1) Serial Port A (RS-232/RS-485 Full Duplex/RS-485 Half Duplex)
	One Ethernet Port (TCP/IP) 100 Base <ul style="list-style-type: none"> Up to 10 Mbps (internal connection) 100 Mbps (external connection) Modbus TCP, TCP/IP
Device compatibility	Rosemount Ultrasonic flow meters are compatible with nearly every commercially available flow computer. Examples: FloBoss 103, FloBoss S600 flow computer, ROC 107.
Digital, analog, and frequency inputs	
Digital Input(s)	(1) Single polarity Note DI1Mode must be set to Digital Input/Calibration Input.

Table 1-5: Model 3418 meter specifications (part 3) (continued)

Analog Input(s)	<p>(2) 4-20 mA</p> <ul style="list-style-type: none"> • AI-1 Temperature • AI-2 Pressure <hr/> <p>Note The analog-to-digital conversion accuracy is within $\pm 0.05\%$ of full scale over the operating temperature range.</p> <hr/> <p>Note AI-1 and AI-2 are electronically isolated and operate in sink mode. The input contains a series resistance so HART® Communicators can be connected to configure sensors.</p> <hr/> <p>A regulated 24 Vdc power output is available to provide power to the sensors.</p>
Frequency/Digital Output(s)	<p>The outputs have user-configurable selections as either a frequency output or digital status (FODO) (Also see Frequency/Digital outputs).</p> <p>Frequency/Digital Outputs</p> <ul style="list-style-type: none"> • FODO1 (eight possible output configurations) • FODO2 (eight possible output configurations) • FODO3 (eight possible output configurations) • FODO4 (eight possible output configurations) • FODO5 (eight possible output configurations) • FODO6 (eight possible output configurations) <hr/> <p>Note Use of FODO6 requires DI1Mode set to Frequency/Digital Output 6. Digital Input will not be available.</p> <hr/> <p>Frequency or Digital Output parameter pairs (see Frequency/Digital outputs) Frequency or Digital Outputs (FODO1, FODO2, FODO3, FODO4, FODO5, FODO6) source selections:</p> <ul style="list-style-type: none"> • (FO1A, DO1A, FO1B, DO1B, FO2A, DO2A, FO2B, DO2B) <hr/> <p>Mode options:</p> <ul style="list-style-type: none"> • Open Collector (requires external excitation supply voltage and pull-up resistor) • TTL (internally powered by the meter 0-5 Vdc signal) <hr/> <p>Channel B Phase options:</p> <ul style="list-style-type: none"> • Lag forward, Lead reverse (Phase B lags Phase A while reporting forward flow, leads Phase A while reporting reverse flow) • Lead forward, Lag reverse (Phase B leads Phase A while reporting forward flow, lags Phase A while reporting reverse flow)

Table 1-5: Model 3418 meter specifications (part 3) (continued)

	<p>Phase A and Phase B output (based on flow direction)</p> <ul style="list-style-type: none"> • Reverse flow - output only reports flow in the reverse direction. For frequency outputs, Phase B of the output is 90 degrees out of phase with Phase A. • Forward flow - output only reports flow in the forward direction. For frequency outputs, Phase B of the output is 90 degrees out of phase with Phase A. • Absolute - output reports flow in both directions. For frequency outputs, Phase B of the output is 90 degrees out of phase with Phase A. • Bidirectional - output reports flow on Phase A only in the forward direction and on Phase B only in the reverse direction. <p>Maximum frequency for the frequency outputs</p> <ul style="list-style-type: none"> • 1000Hz • 5000Hz
<p>Analog Output(s)</p>	<ul style="list-style-type: none"> • (1) 4-20 mA independently configurable analog output • (1) 4-20 mA independently configurable analog output (conventional) - Type 2 CPU only <p>The analog output zero scale offset error is within $\pm 0.1\%$ of full scale and gain error is within $\pm 0.2\%$ of full scale. The total output drift is within ± 50 ppm of full scale per $^{\circ}\text{C}$.</p>
<p>Optional Module Slot Inputs/Outputs</p>	<ul style="list-style-type: none"> • RS-232 module • RS-485 half duplex module • Expansion I/O module

1.12 Pre-installation considerations

- Pipeline equipment code compliance, ANSI, ASME, etc.
- Proper Inlet/outlet meter tube piping for reasonable stable flow to the settling chamber (first meter tube spool upstream of the meter).
- Electrical safety compliance: UL, CSA, ATEX, IECEx etc.
- Civil and structural good practices compliance
- Contractual agreements and/or governmental compliance
- In-situ performance test procedures
- Field tested meter health check and flow dynamics diagnostics
- Data collection and retention procedures

1.13 Safety considerations

The Rosemount 3410 Series Gas Ultrasonic Flow Meter is suitable for use in U.L. Class 1, Division 1, Group C and D hazardous locations.

NOTICE

An "X" signifies the user should contact Emerson for information on the dimensions of the flameproof joints.

Refer to the 3410 Series Systems Wiring Diagram, Sheet 3 (DMC-005324) for the certification tag (see [Rosemount 3410 Series engineering drawings](#)).

3410 Series Gas Ultrasonic Meters are INMETRO certified. Refer to the 3410 Series Gas Ultrasonic Flow Meter Tag, INMETRO Certification drawing DMC-006224.

Certificate number: UL-BR 16.0144X

Marking: Ex db ia IIB T4...T3 Gb

Electrical parameters: Refer to [Meter specifications for Rosemount Model 3418](#) and [Rosemount 3410 Series engineering drawings](#).

Special conditions for safe use

- Explosion proof joint dimensions are compliant with the Brazilian Association of technical standard: ABNT NBR IEC 60079-1, Table 3.
- The enclosure for the explosion proof transmitter and intrinsically safe barrier must be remote mounted) if the operating temperature exceeds 140 °F (60 °C) (refer to [Table 1-3](#)).
- Cable length (refer to [Table 1-3](#)).



WARNING

Explosion or fire hazard

Conduit runs must have a sealing fitting within 18 in. (457 mm) of the enclosure to reduce the risk of an explosion or a fire.

- During operation, keep covers tight.
- During equipment maintenance, disconnect power before opening transmitter or base electronics. Clean cover joints before replacing.
- DO NOT substitute meter components. Component substituting may compromise the intrinsic safety.

Failure to comply could result in severe injury to personnel or cause damage to the equipment.

1.14 Certifications and approvals for the Rosemount 3410 series

3410 Series Gas Ultrasonic Flow Meters have electrical, metrology, intrinsic safety and Pressure Equipment Directive certifications and approvals by the agencies listed below. Refer to the nameplate tag on the meter body, the wiring diagram (DMC-005324) in [Rosemount 3410 Series engineering drawings](#) and observe all safety precautions. 3410 Series Gas Ultrasonic Flow Meters operate within the pressure and temperature range of the device (also see [Meter specifications for Rosemount Model 3418](#)). 3410 Series Gas Ultrasonic Flow Meters are approved to the ATEX Directive 94/9/EC.

Standards

- US
- Canada
- Europe
 - Explosive Atmospheres (ATEX)
 - International Electrotechnical Commission (IECEX)
 - Pressure Equipment Directive (PED via BSI)
 - Electromagnetic Compatibility (EMC)
 - International Organization of Legal Metrology (OIML)

Approval agencies

- UL
- c-UL
- DEMKO
- INMETRO
- NEPSI
- GOSTR

Important

Please consult Emerson Flow services for Rosemount products for the complete metrology approvals list.

1.15 FCC compliance

This equipment has been tested and found to comply with the limits for a Class A digital device, pursuant to Part 15 of the FCC Rules. These limits are designed to provide reasonable protection against harmful interference when the equipment is operated in a commercial environment.

This equipment generates, uses, and can radiate radio frequency energy and, if not installed and used in accordance with the instruction manual, may cause harmful interference to radio communications. Operation of this equipment in a residential area is likely to cause harmful interference. In such a case, the user will be required to correct the interference at their own expense.

NOTICE

Changes or modifications not expressly approved by the party responsible for compliance could void the user's authority to operate the equipment.

1.16 References

1. *Gould Modbus Protocol Reference Guide*, Rev. B, PI-MBUS-300
2. *Measurement of Fuel Gas By Turbine Meters*, American Gas Association, Transmission Measurement Committee Report No. 7, Second Revision, April 1996 (also referred to as AGA7)
3. *Compressibility Factors of Natural Gas and Other Related Hydrocarbon Gases*, American Gas Association, Transmission Measurement Committee Report No. 8, Second Edition, Second Printing, July 1994 (also referred to as AGA8)

4. Speed of Sound in Natural Gas and Other Related Hydrocarbon Gases, Report 10, First Edition, May 2003 (also referred to as AGA10)
5. Manual of Petroleum Measurement Standards, Chapter 21 — Flow Measurement Using Electronic Metering Systems, Section 1 — Electronic Gas Measurement, American Gas Association and American Petroleum Institute, First Edition, September 1993
6. AGA Report No. 9, Measurement of Gas by Multipath Ultrasonic Meters, Second Edition (April 2007)

2 Mechanical installation

2.1 Meter piping, lifting and mounting

Refer to the following sections for piping recommendations, lifting with hoist rings and slings, mounting in heated or cooled pipelines and safety warnings and precautions.

! WARNING

Cutting hazard

Sharp edges may be present on the transducer retaining ring.

Wear appropriate eye protection equipment when removing or installing the transducer retaining ring.

Failure to comply could cause serious injury.

! WARNING

Crushing hazard

Do not remove flange stabilizers.

Attempting to do so could allow the meter to roll, resulting in serious injury or equipment damage.

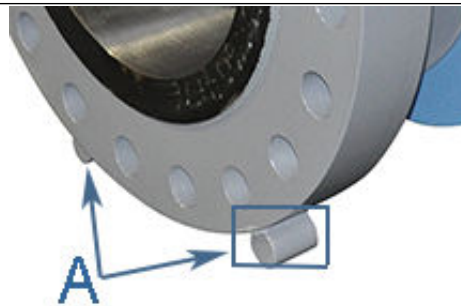

A. Flange stabilizers

! WARNING

Crushing hazard

Before installation, do not rest the meter on a slope of greater than 10 degrees. Also ensure the surface is solid so that the flange stabilizers do not sink into the surface.

Failure to comply could allow the meter to roll, resulting in serious injury or equipment damage.

! CAUTION

Surface temperature hazard

The meter body and piping may be extremely hot or cold.

Wear appropriate personal protective equipment when coming in contact with the meter.

Failure to comply may result in injury.



CAUTION

Transportation hazard

When moving the meter, do not insert the forks of a forklift into the bore.

Inserting the forks may cause the meter to become unstable, resulting in injury or damage to the bore and sealing face.



CAUTION

Tripping hazard

Clear all obstacles or obstructions from the work area when transporting, installing, or removing the meter.

Failure to clear the work area may cause injury to personnel.



CAUTION

Escaping gases or fluids hazard

The purchaser of the meter is responsible for the selection of Rosemount components/seals and materials compatible with the chemical properties of gas flow measurement.

Failure to select the suitable meter component/seals may cause escaping gases or liquids, resulting in injury or equipment damage.



CAUTION

Escaping gases or fluids hazard

Process Seal Materials Single Seal Certification (T-XX and T-200 Transducers)

- Wetted material for T-XX style transducers are 316 stainless steel (SS) or Inconel holders with Hastelloy-C pins, Stycast 2850 Epoxy, and glass.
- Wetted materials for T-200 Style transducers are titanium housing and NBR (Nitrile) or FKM (Viton) O-ring material.

Only Rosemount specified O-ring replacements shall be used for process seal O-ring materials for T-200 transducers. No substitutions are allowed to maintain process seal integrity.

Verify chemical compatibility of material with components of process fluid.

Reference [Parker Seals – Chemical Compatibility Catalog EPS 5350](#).

Failure to select the suitable meter seals may cause escaping gases or liquids, resulting in injury or equipment damage.

Consult your Emerson Flow sales and service representative to ensure you purchase the correct components and seals for your application.

2.2 Piping recommendations

! WARNING

Burst hazard

Before pipeline cleaning and maintenance ("pigging operations"), remove straightening vanes or flow conditioners.

Failure to comply may cause excessive pressure in the meter system, resulting in death, serious injury or equipment damage.

The excessive pressure may damage the meter or the transducer ports may collect debris which may impede data acquisition and flow measurement.

Figure 2-1: Rosemount 3410 Series Gas Ultrasonic Flow Meter with flow conditioner for uni-directional flow

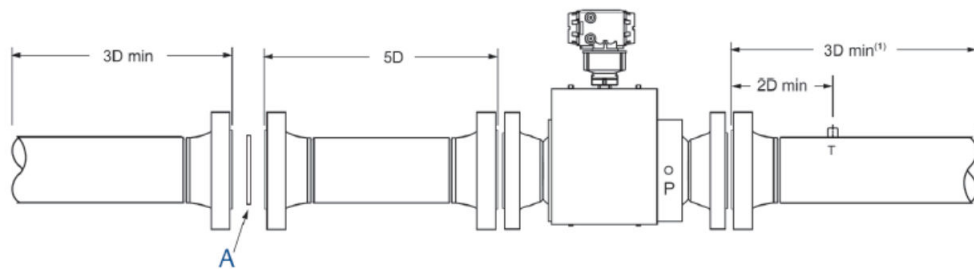

A. Flow conditioner: Rosemount profiler, CPA 50E or CPA 55E

Figure 2-2: 3410 Series Gas Ultrasonic Flow Meter with flow conditioner for bi-directional flow

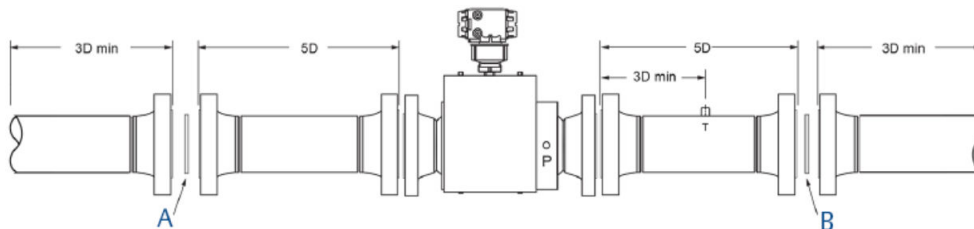

A. Flow conditioner: Rosemount profiler, CPA 50E or CPA 55E

B. Flow conditioner: Rosemount profiler, CPA 50 E or CPA 55E

Sunshields, provided by the customer, may be required to prevent exceeding the transmitter electronics maximum temperature when the meter is mounted in a location with extremely hot climates.

NOTICE

Sunshield protection

Install a sunshield to prevent prolonged exposure to direct sunlight in extreme climates.

Failure to shield the meter may result in exceeding the ambient temperature range and damage transmitter electronics.

NOTICE

For optimal flow measurement conditions, Rosemount suggests the piping configurations below. Regardless of the configuration selected, the user agrees to accept full responsibility for the site piping design and installation.

Flow conditioning is recommended for best measurement results

- Honed or un-honed meter tube(s)
 - Flow direction (unidirectional or bidirectional)
 - Correct meter size selection - too low may cause poor flow stability (thermal convection) or too fast may cause erosion problems and resonance, cracks or failure of probes or thermowells (approximately 0.3 to 30 m/sec or 1 to 100 ft/sec).
 - Space availability for meter lengths (to allow inlet piping customization):
-

Important

The bore of the mating piping should be within one percent of the meter inside diameter.

Figure 2-3: Piping Recommendation Uni-directional Gas Ultrasonic Meter without Flow Conditioner

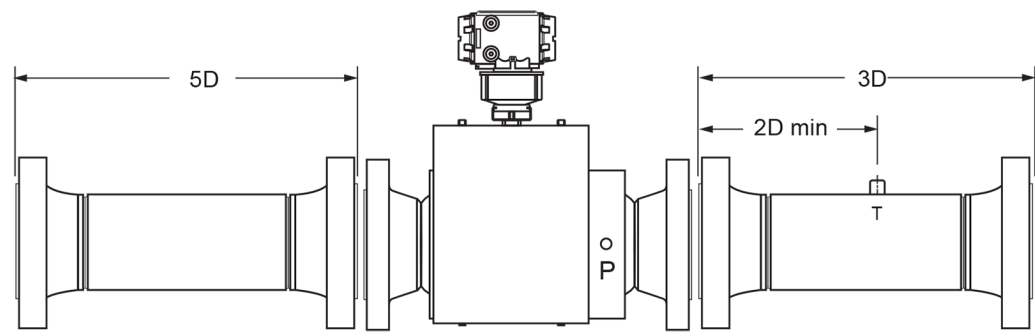
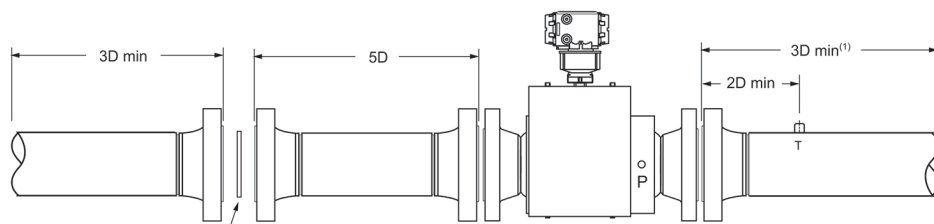

Figure 2-4: Piping Recommendation Uni-directional Gas Ultrasonic Meter with Flow Conditioner



Flow Conditioner: Daniel Profiler, CPA 50E or CPA 55E

All pipe lengths are minimum:

- P = Pressure measurement location
- T = Temperature measurement location

(1) For best results, flow conditioning is recommended

(2) D = Nominal pipe size in inches (i.e., 6-in. pipe; 10D = 60-in.)

3410 Series Ultrasonic Gas Flow Meters should be mounted in horizontal piping with the chord paths horizontal.

NOTICE

Faulty meter installation
Correctly install the equipment.

If meter bodies are mounted or oriented differently than specified above, debris or gas may collect in the transducer ports which could adversely affect the transducer signals, or cause equipment damage.

- Normally, the meter body is installed so that the electronics assembly is on the top of the meter. If there is insufficient space above the piping for this arrangement, the meter can be ordered with extra long transducer cables for remote mounting or the meter housing can be installed with the electronics assembly on the bottom.
- The mating piping should include temperature measurement connections located a minimum of three nominal pipe diameters length down stream of the meter, or per AGA Report No. 9.

2.3 Pre-installation inspection

Upon receipt of the meter and before installation inspect meter for signs of components loosening, seal damage or other component damage. This includes:

Procedure

1. Ensure flange sealing faces are undamaged.
2. Ensure that components that should be rigid do not move.
If any damage is found, contact Emerson Flow services before putting meter into service. Refer to the [Emerson.com/global](https://emerson.com/global) for contact information.

2.3.1 Meter safety for hoist rings and lifting slings

A Rosemount Gas Ultrasonic Flow Meter can be safely lifted and maneuvered into and out of a meter run for installation or service by obeying the following instructions.

 **DANGER**

LIFTING A ROSEMOUNT ULTRASONIC METER WITH OTHER EQUIPMENT

The following lifting instructions are for installation and removal of the Ultrasonic Meter ONLY.

The instructions below do not address lifting the meter while it is attached, bolted, or welded to meter tubes, piping, or other fittings.

Using these instructions to maneuver the meter while it is still attached, bolted, or welded to a meter tube, piping, or other fitting can result in death, serious injury, or equipment damage.

The operator must refer to their company's hoisting and rigging standards, or the "DOE-STD-1090-2004 Hoisting and Rigging" standard if such company standards do not exist, for lifting and maneuvering any assembled meter tube and associated piping.

! WARNING

Crushing hazard

During meter installation or removal, always place the meter on a stable platform or surface that supports its assembled weight.

Failure to comply could allow the meter to roll, resulting in serious injury or equipment damage.

NOTICE

Prior to lifting the meter, refer to the 3418 Gas Ultrasonic Flow Meter nameplate or outline dimensional (general arrangement) drawing for the assembled weight.

When lifting a meter by itself, Emerson recommends two methods. These methods are:

- Using appropriately rated Safety Engineered Swivel Hoist Rings installed in the meter end flanges.
- Using appropriately rated lifting slings positioned at designated areas of the meter.

Both methods must be used in conjunction with all appropriate company hoisting and rigging standards or the DOE-STD-1090-2004 HOISTING AND RIGGING standard if such company standards do not exist. For more information on these two methods, refer to the following sections.

Appropriate safety-engineered swivel hoist rings in meter end flanges

Rosemount Ultrasonic meters come equipped with a tapped hole located on the top of each meter body end flange. A flat machined surface surrounds each tapped hole. This feature provides complete surface contact **ONLY** between the meter flange and an OSHA-compliant Safety Engineered Swivel Hoist Ring as shown in [Figure 2-6](#).

Operators **SHALL NOT** use Eye Bolts (see [Figure 2-7](#)) in the flange tapped holes to aid in lifting or maneuvering the meter.

Operators **SHALL NOT** use other Hoist Rings that do not fully seat flush with the counter bore on the top of the meter flanges.

Figure 2-5: Meter end flange with tapped flat-counterbore hole for hoist ring

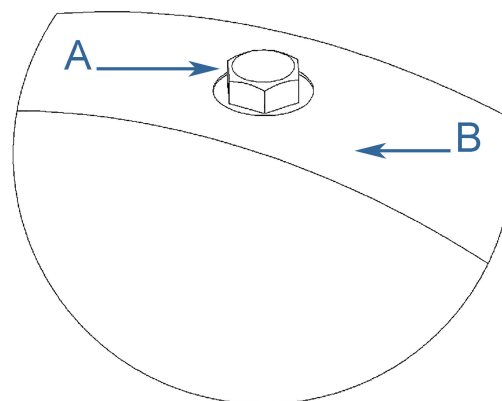

- A. Plug bolt
B. Flat counterbore surface
-

Figure 2-6: Safety-approved hoist ring

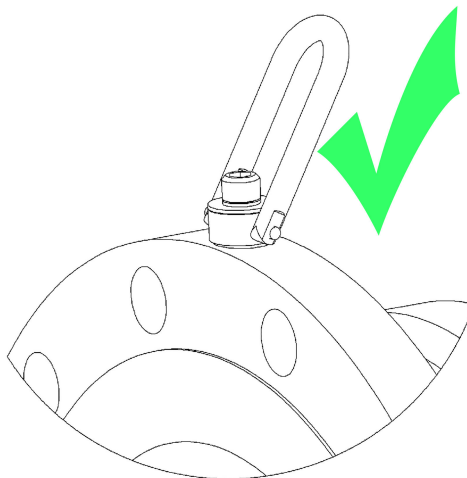

Figure 2-7: Non-compliant eye bolt



Safety precautions using safety-engineered swivel hoist rings

Read and follow the Safety Precautions listed below:

1. Meters must only be lifted by personnel properly trained in the safe practices of rigging and lifting.
2. Remove the plug bolts installed in the tapped holes on the top of the flanges. Do not discard the bolts as they must be reinstalled once the lifting operation is complete to prevent corrosion of the tapped holes.
3. Ensure the tapped holes on the meter are clean and free of debris before installing the hoist rings.
4. Use only the safety-engineered swivel hoist rings that are rated for lifting the meter. Do not use any other type of hoist rings with the same screw size or heavy duty hoist rings. The meter tapping and counter bore size are suitable only for the hoist rings specified by Emerson.

5. When installing a hoist ring, ensure the base surface of the hoist ring fully contacts the machined flat surface of the tapped hole. If the two surfaces do not come in contact then the hoist ring will not hold its full rated load. Torque the hoist ring attachment bolts to the limit indicated on the hoist rings.
6. After installation of the hoist rings, always check that the ring rotates and pivots freely in all directions.
7. NEVER attempt to lift the meter using only one hoist ring.
8. Always use separate slings to each hoist ring. NEVER reeve one sling through both hoist rings. The slings must be of equal length. Each sling must have a load rating that equals or exceeds the hoist ring load rating. The angle between the two slings going to the hoist rings must never exceed 90 degrees or the load rating of the hoist rings will be exceeded.

Figure 2-8: Correct sling attachment for Shell Shroud meters

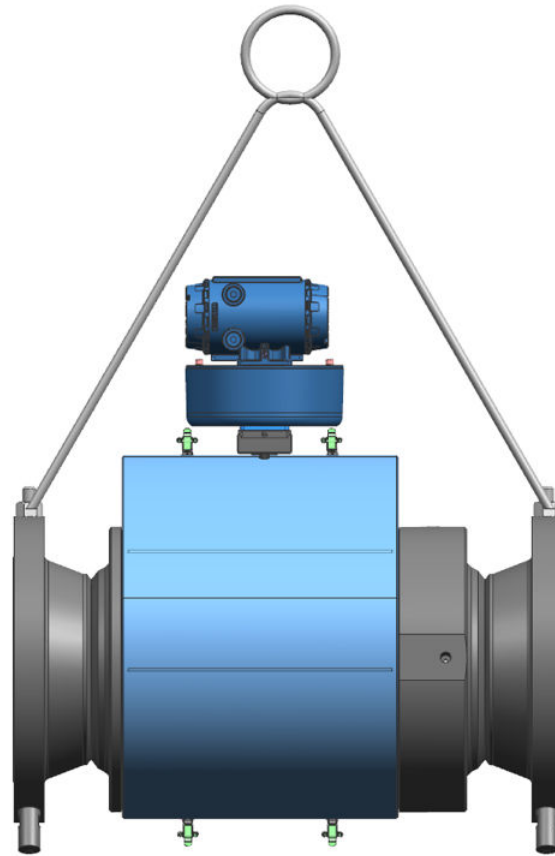

9. NEVER allow the slings to contact the electronics enclosure. Damage to the enclosure may occur. Use a spreader bar with the slings to prevent contact with the electronics enclosure and the base enclosure (see [Safety precautions using appropriately rated lifting slings](#)). If the slings do come in contact with the electronic enclosure, then remove the two bolts holding the enclosure to its base and temporarily remove the head from the meter during the lifting operation. You will need to unplug the cable from J3 on the Acquisition Module. Two screws hold this cable in place.

- a. After the lifting operation is complete, reattach and secure the electronics cable to J3 on the Acquisition Module.
- b. Return the electronics enclosure to its original position.
- c. Replace the bolts.
- d. Secure the enclosure in place.



CAUTION

FALL HAZARD

Lifting the meter with the upper enclosure installed but without the bolts installed, may cause the electronics to fall and cause personal injury or equipment damage.

Figure 2-9: Incorrect sling attachment

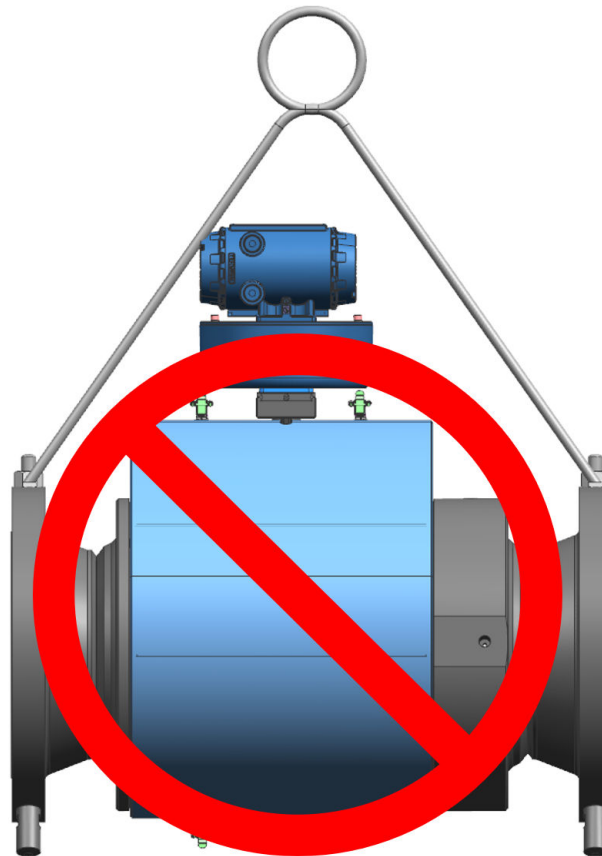

10. NEVER apply shock loads to the meter. Always lift the meter gradually. If shock loading ever occurs, the hoist ring must be inspected per manufacturer's recommendations prior to any further service. If a proper inspection cannot be performed, discard the hoist ring.
11. NEVER lift with any device, such as hooks, chains, or cables that could create side pulls that could damage the ring of the hoist ring.
12. NEVER lift more than the ultrasonic meter assembly including electronics and transducers with the hoist rings. The only exception that safe is to lift the meter with one ASME B16.5 or ASME B16.47 blind flange bolted to each end flange of the

meter. NEVER use the hoist rings on the meter to lift other components such as meter tubes, piping or fittings attached to the meter. Doing so will exceed the load rating of the hoist rings.

13. Remove the hoist rings from the meter after lifting is completed and store them in an appropriate case or container per their manufacturer's recommendation.
14. Apply heavy lubricant or anti-seize to the threads of the plug bolts and reinstall the plug bolts to keep the tapped holes free of debris and to prevent corrosion.

Obtain safety engineered swivel hoist rings

A list of approved manufacturers of safety engineered hoist rings is below:

- [American Drill Bushing Company](#)
- [Carr Lane Manufacturing Company](#)

Select an approved supplier from the list below. These vendors can supply the safety engineered hoist rings. This is not intended to be a complete list.

- [Fastenal](#)
- [Reid Supply](#)

The appropriate hoist rings can also be purchased directly from Emerson. The following table provides part numbers for reference:

Table 2-1: Hoist ring part number lookup table

Rosemount part number ⁽¹⁾	Hoist ring thread size & load rating ⁽¹⁾	American Drill Bushing Co. P/N ⁽¹⁾	Carr Lane Manufacturing Co. P/N ⁽¹⁾
1-504-90-091	3/8-in.-16UNC, 1000 lb.	23053	CL-1000-SHR-1
1-504-90-092	1/2-in.-13UNC, 2500 lb.	23301	CL-23301-SHR-1
1-504-90-093	3/4-in.-10UNC, 5000 lb.	23007	CL-5000-SHR-1
1-504-90-094	1-in.-8UNC, 10000 lb.	23105	CL-10000-SHR-1
1-504-90-095	1-1/2-in.-6UNC, 24000 lb.	23202	CL-24000-SHR-1

(1) The part numbers include only one hoist ring. Two hoist rings are required per meter.

Needed size for safety engineered swivel hoist rings

To determine the size of the hoist rings required for your meter, use the appropriate table below. Look down the column that matches the ANSI rating of your meter. Find the row that contains your meter size. Follow the row to the end to find the appropriate hoist ring part number.

Table 2-2: Hoist Ring look-up table for Rosemount 3418 gas meter

ANSI 300	ANSI 600	Rosemount Part Number	Thread
8 to 12 in.	8 to 12 in.	1-504-90-092	1/2 in.
16 to 24 in.	16 to 20 in.	1-504-90-093	3/4 in.
30 to 36 in.	24 to 30 in.	1-504-90-094	1 in.
-	36 in.	1-504-90-095	1 1/2 in.

Appropriately rated lifting slings

The following instructions are intended to provide general guidelines for using proper lifting slings when lifting a Rosemount 3410 Series Gas Ultrasonic Flow Meter by itself. These instructions are intended to be followed in addition to your company's standards or the [DOE-STD-1090-2004 Hoisting and Rigging standard](#) if such company standards do not exist.

Safety precautions using appropriately rated lifting slings

1. Meters must only be lifted by personnel properly trained in the safe practices of rigging and lifting.
2. NEVER attempt to lift the meter by wrapping slings around the electronics enclosure.
3. NEVER attempt to lift the meter using only one sling around the meter. Always use two slings wrapped around each end of the body as shown below. A choker style sling is recommended.

Figure 2-10: Correct sling attachment

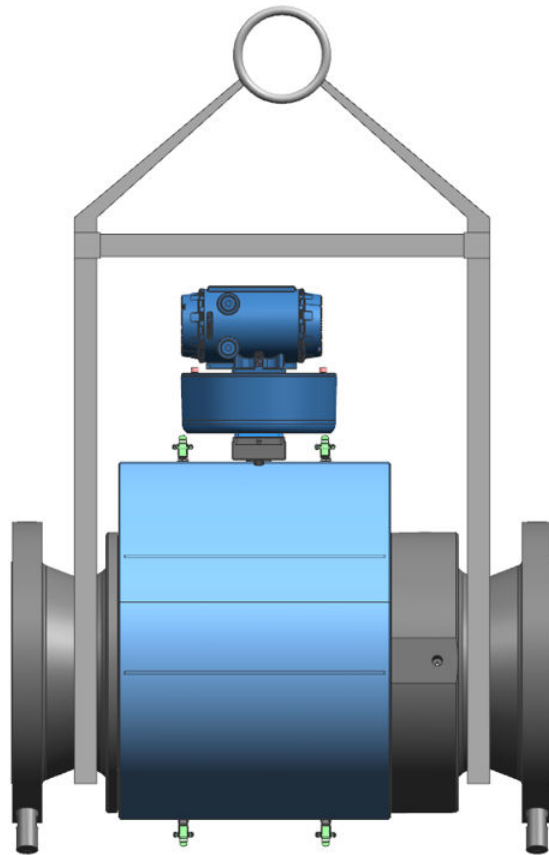

4. Visually inspect the slings prior to use for any signs of abrasion or other damage. Refer to the sling manufacturer's procedures for proper inspection of the particular sling you are using.

5. Only use slings with ratings that exceed the weight to be lifted. Reference your company's standards for safety factors that must be included when calculating the load rating.
6. NEVER allow the slings to contact the electronics enclosure or the transducer cabling. Damage to the meter may occur. If the slings do come in contact with the electronics enclosure, then remove the two bolts holding the enclosure to its base and temporarily remove the head from the meter during the lifting operation. (Remove the two bolts holding the enclosure to its base and unplug the cable from the Acquisition Module. Two screws hold this cable in place.) Use a spreader-bar on the slings to prevent contact with the electronics.
7. Once the lifting operation is complete, reattach and secure the electronics cable to J3 on the Acquisition Module, return the electronics enclosure to its original position, replace the bolts, and secure the enclosure in place. Lifting the meter with the upper enclosure installed but without the bolts installed, may cause the electronics to fall and cause personal injury or electronics damage.

Figure 2-11: Incorrect sling attachment

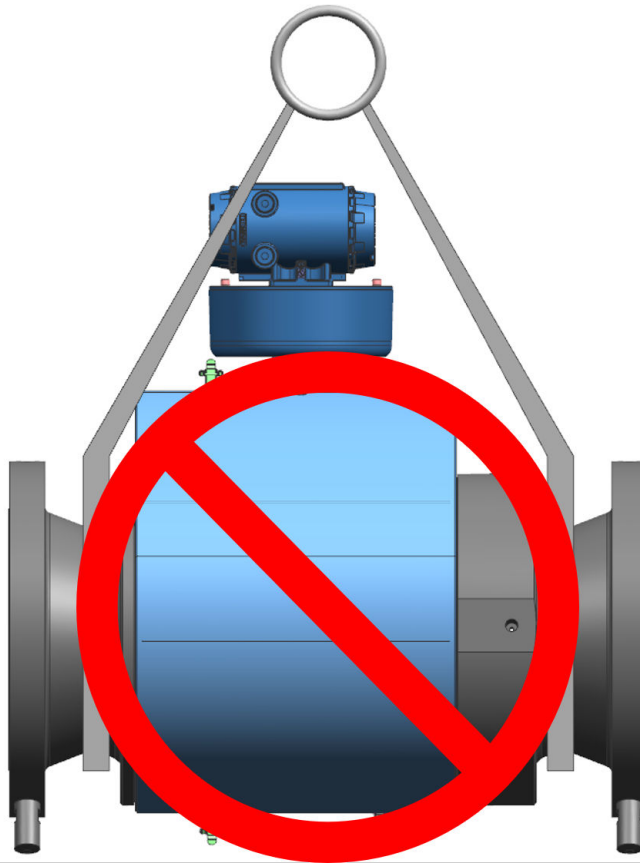

8. NEVER apply shock loads to the meter. Always lift the meter gradually. If shock loading ever occurs, the slings must be inspected per manufacturer's procedures prior to being placed in any further service.

2.4 Mounting requirements in heated or cooled pipelines

The ambient operating temperature of the Rosemount 3410 Series Gas Ultrasonic Flow Meter electronics (i.e. Flameproof enclosure and Intrinsically safe base enclosure) is -40 °F (-40 °C) to +140 °F (+60 °C).

The electronics mounting bracket thermally isolates the heated or cooled meter body from the electronics. Thus the process fluid can be outside operating the electronics temperature.

T-21 transducers have an operating range from -4 °F (-20 °C) to +212 °F (+100 °C). T-22 and T-41 transducers have an operating range from -58 °F (-50 °C) to +212 °F (+100 °C). T-200 transducers have an operating range from -58 °F (-50 °C) to +257 °F (+125 °C).



CAUTION

Surface temperature hazard

The meter body and piping may be extremely hot or cold.

Wear appropriate personal protective equipment when coming in contact with the meter.

Failure to comply may result in injury.

3 Electrical installation

3.1 Cable length TTL mode

The maximum cable length is 2000 feet (609.6 m) when the Digital Output “TTL” mode is selected.

3.2 Cable length Open Collector mode

For the Digital Output open collector mode, the maximum cable length depends on the cable parameters, pull-up resistance used, the maximum frequency to output, and frequency input parameters being driven. The following table provides estimated cable lengths for different pull-up resistor values and different Max Frequency settings in the meter using the following cable parameters. The table also provides an estimated cable voltage drop which indicates how much voltage will be across the cabling and effectively indicates to what voltage level the frequency input can be pulled down to by the frequency output.

If the voltage drop is higher than the voltage required for the frequency input to see a low state, then the configuration will most likely not work for your system. Performance of frequency outputs will vary from this table with setup and frequency input being driven.

Table 3-1: Configurations for open collector frequency outputs

Cable	Cable resistance	Cable	Pull-up resistance	Total	Maximum frequency	Sink	Cable voltage drop
Length (x1000 ft)	(2 Conductors) Ω	Capacitance nF	Resistance Ω	Resistance Ω	Frequency (Hz)	Current (A)	(2 Conductors) Vdc
0.5	16.8	10.00	1000	1016.8	5000	0.024	0.397
1	33.6	20.00	1000	1033.6	1000	0.023	0.780
2	67.2	40.00	1000	1067.2	1000	0.022	1.511
4	134.4	80.00	1000	1134.4	1000	0.021	2.843
0.5	16.8	10.00	500	516.8	5000	0.046	0.780
1	33.6	20.00	500	533.6	5000	0.045	1.511
1.7	57.12	34.00	500	557.12	5000	0.043	2.461
6.5	218.4	130.00	500	718.4	1000	0.033	7.296

The 22 AWG wire characteristics:

- Capacitance = 20 pF/ft. or 20 nF/1000 ft. (between two wires)
- Resistance = 0.0168 Ohms/ft or 16.8 Ohms/1000 ft
- Pull-up voltage = 24 Vdc

3.3 Grounding meter electronics housing

NOTICE

The meter electronics should be internally grounded for intrinsically safe operations.

Connect a wire to the chassis ground lug installed inside the Transmitter Electronics Enclosure as the primary ground. A secondary ground is located outside of the Transmitter Electronics Enclosure (see [Figure 3-2](#)).

NOTICE

The internal grounding terminal shall be used as the primary equipment ground. The external terminal is only a supplemental bonding connection where local authorities permit or require such a connection. DO NOT connect digital grounds to the ground lugs.

Figure 3-1: Internal Transmitter Electronics Enclosure chassis ground

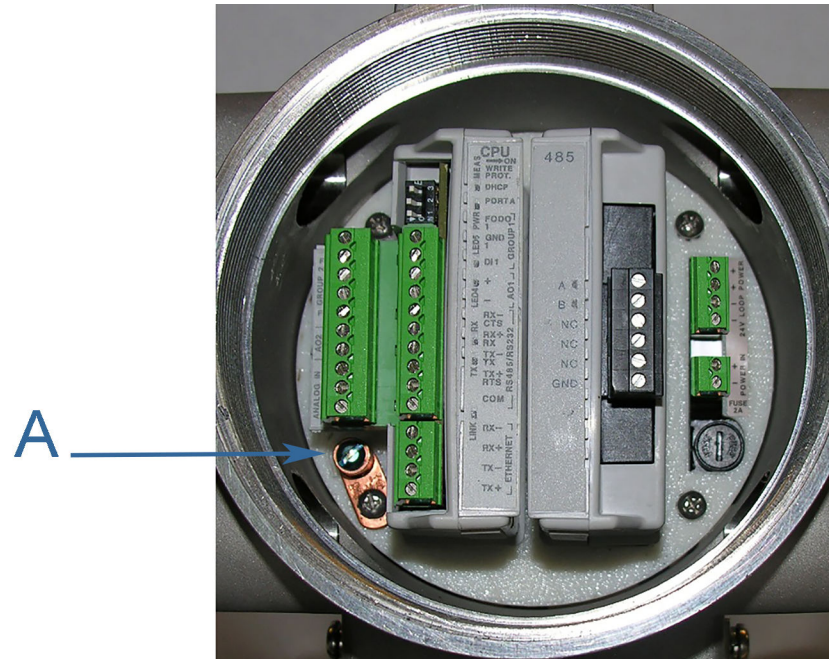

A. Transmitter electronics enclosure ground lug

Figure 3-2: External ground lug

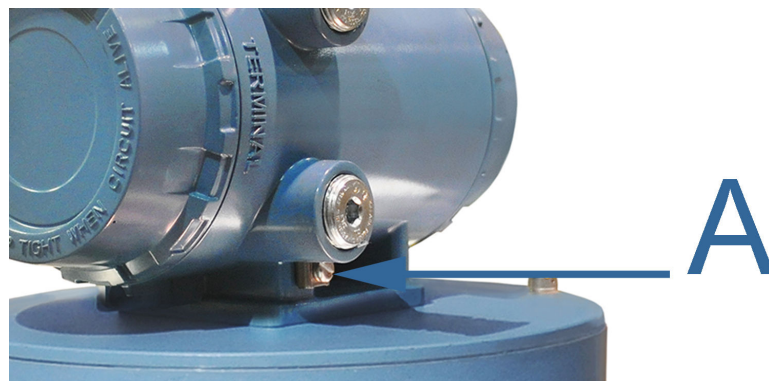

A. External ground lug

3.4 Conduit seals

Conduit seals are required for meter installations in hazardous environments. Adhere to safety instructions to protect personnel and equipment.



WARNING

Explosion hazard

To reduce the risk of an explosion or fire, conduit runs must have a sealing fitting connected within 18 in. (457.2 mm) of the enclosure. Substitution of components may impair intrinsic safety of the meter.

Failure to keep covers tight during operation could result in death or serious injury.



WARNING

Explosion hazard

Substitution of components may impair the intrinsic safety and cause ignition of flammable or combustible atmospheres. Disconnect power before servicing.

Failure to remove power and use Rosemount approved components could cause serious injury.

3.4.1 Start-up for systems that use explosion-proof conduit

Procedure

1. Assemble conduit to the transmitter electronics enclosure. A conduit seal fitting is required within 18 in. (457 mm) of the enclosure.
2. Check to make certain that all power to field wiring is turned **OFF**.



WARNING

Hazardous voltage inside

Do not open the Transmitter Electronics Enclosure when an explosive gas atmosphere is present. Disconnect equipment from supply circuit before opening the enclosure.

Failure to remove power could result in death or serious injury.

3. Remove the end cap nearest the conduit entry to gain access to the transmitter electronics.
4. Pull the wires into the electronics enclosure. Complete the field connection wiring as shown in [Figure 3-3](#).
5. Complete the field connection wiring and apply electrical power to the system.

Figure 3-3: Electronics field wiring - upper terminal block, switches, ground lug - Type 2 central processing unit (CPU) Module

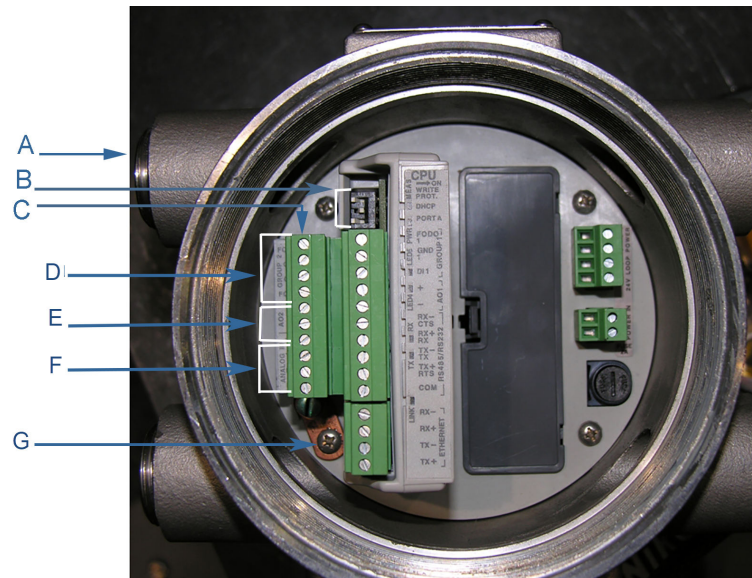

- A. Conduit wiring entry (four entries)
- B. Switches
 - A. Port A
 - B. DHCP
 - C. WRITE PROT.
- C. Upper terminal block
- D. FODO Group 2
 - FODO2
 - GND2
 - FODO3
- E. Analog out (current 4-20 mA)
 - AO2+
 - AO2-
- F. Analog in
 - Analog in (AI1)
 - Analog input 1 (Temperature)
 - TT+
 - TT-
 - Analog in
 - Analog input 2 (Pressure)
 - PT+
 - PT-
- G. Ground lug

Figure 3-4: Transmitter electronics field wiring lower terminal block - Type 2 CPU Module

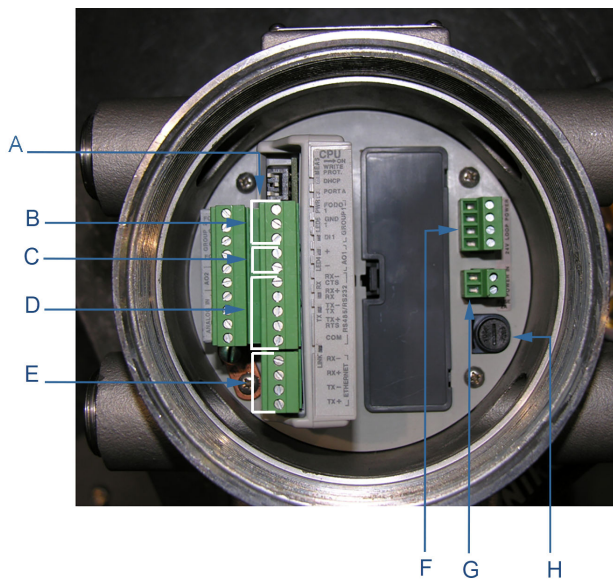

- A. Lower terminal block
- B. FODO Group 1 connections
 - FODO1
 - GND1
 - DI 1
- C. AO1
 - AO1+
 - AO1-
- D. Serial COMs (RS-232, RS-485)
 - RS-232: RTS, TX, CTS
 - RS-485: TX+, TX-, RX+, RX- (four-wire full duplex)
 - RS-485: TX+, TX- (two-wire half duplex)
- E. Ethernet
 - Ethernet (orange and white wire)
 - Ethernet (orange wire)
 - Ethernet (green and white wire)
 - Ethernet (green wire)
- F. 24 V loop power (for sourcing 4-20 mA inputs/outputs)
- G. Power in (10.4 Vdc - 36 Vdc)
- H. Fuse cover

Figure 3-5: Electronics field wiring - upper terminal block, switches, ground lug - Type 4CPU Module

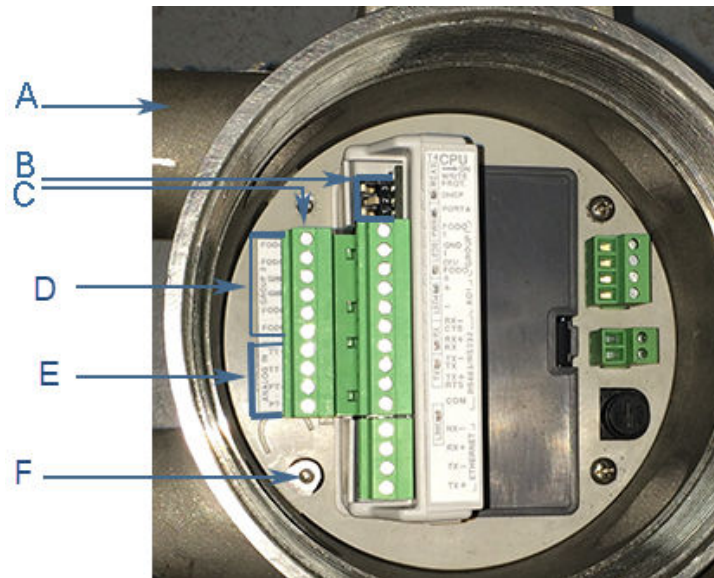

- A. Conduit wiring entry (four entries)
- B. Switches
 - A. Port A
 - B. DHCP
 - C. WRITE PROT.
- C. Upper terminal block
- D. FODO Group 2
 - FODO2
 - FODO3
 - GND2
 - FODO4
 - FODO5
- E. Analog in
 - Analog in (AI1)
 - Analog input 1 (Temperature)
 - TT+
 - TT-
 - Analog in (AI2)
 - Analog input 2 (Pressure)
 - PT+
 - PT-
- F. Ground lug

Figure 3-6: Transmitter electronics field wiring lower terminal block - Type 4 CPU Module

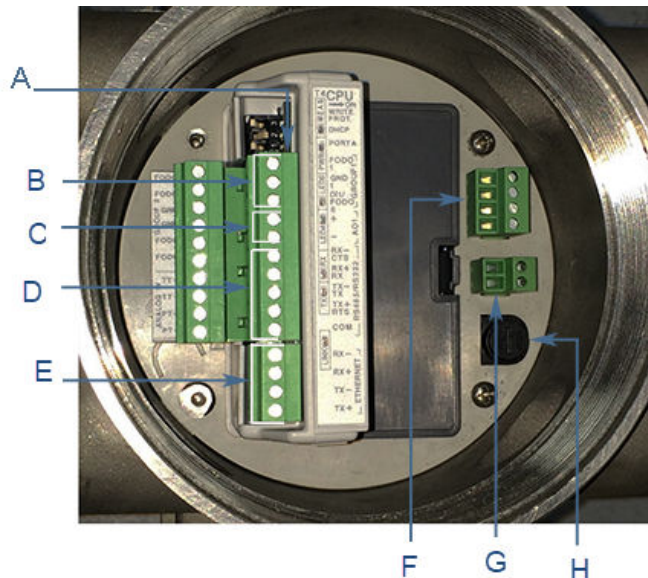

- A. Lower terminal block
- B. FODO Group 1 connections
 - FODO1
 - GND1
 - DI 1/FODO6
- C. AO1
 - AO1+
 - AO1-
- D. Serial COMs (RS-232, RS-485)
 - RS-232: RTS, TX, RX, CTS
 - RS-485: TX+, TX-, RX+, RX- (four-wire full duplex)
 - RS-485: TX+, TX- (two-wire half duplex)
- E. Ethernet
 - Ethernet (orange and white wire)
 - Ethernet (orange wire)
 - Ethernet (green and white wire)
 - Ethernet (green wire)
- F. 24 V loop power (for sourcing 4-20 mA inputs/outputs)
- G. Power in (10.4 Vdc - 36 Vdc)
- H. Fuse cover

6. Set or configure the meter operating parameters using MeterLink. For additional installation information refer to the system wiring diagram (see [Rosemount 3410 Series engineering drawings](#)), [MeterLink Software for Gas and Liquid Ultrasonic](#)

[Meters Quick Start Manual](#) (00809-0100-7630). Use the MeterLink Field Setup Wizard to complete the configuration.

7. Verify the field connections are working correctly. Allow the system to run for the time specified by the customer (usually one week) and an electrician has fully tested the connections. After the Acceptance Test is witnessed and approved, seal the conduit.
8. Power down the system and apply the sealing compound to the conduit and allow to set in accordance with manufacturer specifications.
9. If required, install the security latches and wire seals on the Transmitter Electronics Enclosure endcaps (see [Seal transmitter electronics enclosure](#)).
10. If required, install the wire seals through the socket head bolts on the Base Enclosure (see [Base enclosure security seals](#)).
11. Re-apply electrical power to the system.

3.4.2 Start-up for systems that use flame-proof cable

 **WARNING**

Hazardous voltage inside

Do not open the Transmitter Electronics Enclosure when an explosive gas atmosphere is present. Disconnect equipment from supply circuit before opening the enclosure.

Failure to remove power could result in death or serious injury.

Procedure

1. Check to make certain that all field wiring power is turned **OFF**.
2. Remove the end cap nearest the cable entries to gain access to the transmitter electronics.
3. Install the cable and cable gland.
4. Complete the field connection wiring and apply electrical power to the system.
5. Set or configure the meter operating parameters using MeterLink. For additional installation information refer to the system wiring diagram (see [Rosemount 3410 Series engineering drawings](#)), [MeterLink Software for Gas and Liquid Ultrasonic Meters Quick Start Manual](#) (00809-0100-7630) and use the MeterLink Field Setup Wizard to complete the configuration.
6. Verify the field connections are working correctly. Allow the system to run for the time specified by the customer (usually one week) and an electrician has fully tested the connections. After the Acceptance Test is witnessed and approved, seal the conduit.
7. Power down the system. Apply the sealing compound to the conduit and allow to set in accordance with manufacturer specifications.
8. If required, install the security latches and wire seals on the Transmitter Electronics Enclosure endcaps (see [Seal transmitter electronics enclosure](#)).
9. If required, install the wire seals through the socket head bolts on the Base Enclosure (see [Base enclosure security seals](#)).
10. Re-apply electrical power to the system.

3.5 Wiring and inputs/outputs

MeterLink uses the TCP/IP protocol to communicate with the Rosemount 3410 Series Ultrasonic Gas Flow Meter electronics instead of Modbus ASCII or RTU. The TCP/IP protocol

only works across either Ethernet, RS-485 full duplex (4-wire) or RS-232. MeterLink can communicate with multiple meters if they are multi-dropped using 4-wire, full duplex RS-485 mode.

Note

Port B for RS-485 full duplex communication is not supported.

NOTICE

If not using Ethernet, a full duplex serial connection is necessary for MeterLink to communicate with a 3410 Series Gas Ultrasonic Meter.

The 3410 Series Gas Ultrasonic Flow Meter electronics auto-detects the protocol used and automatically switches between TCP/IP, Modbus ASCII, and Modbus RTU so it is not necessary to make any meter configuration changes to the protocol.

Each Serial Port can be independently configured as Read-only which will prevent write access to configuration points and prevent firmware downloads.

3.5.1 Central processing unit (CPU) Module labeling and LED indicators

The meter's metrology mode and the status of the data transfer from the Acquisition Module to the CPU Module are indicated via light-emitting diode (LED) status indicators. The **WRITE PROT.** switch protects the meter's configuration.

Figure 3-7: CPU Module labeling and LED indicators - Type 2

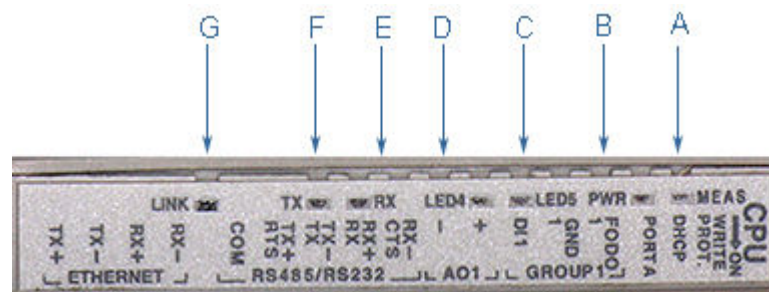

- A. Acquisition/Measurement mode
- B. Power
- C. LED 5: communication between CPU and acquisition module
- D. LED 4: link between CPU and acquisition module
- E. RX (RS-485/RS-232): receiving data
- F. TX (RS-485/RS-232): transmitting data⁽¹⁾
- G. Link (Ethernet 1 link): user Ethernet connection

⁽¹⁾ For RS-485 two-wire, use TX+ and TX-.

Figure 3-8: CPU Module labeling and LED indicators - Type 4

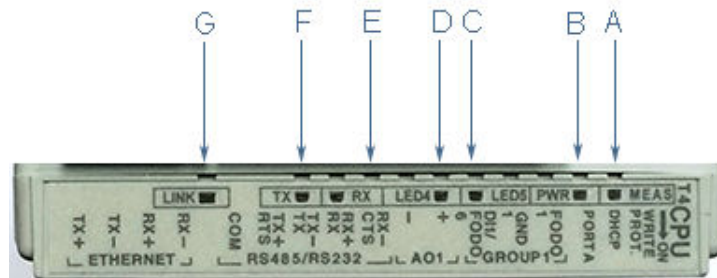

- A. Acquisition/Measurement mode
- B. Power
- C. LED 5: communication between CPU and acquisition module
- D. LED 4: link between CPU and acquisition module
- E. RX (RS-485/RS-232): receiving data
- F. TX (RS-485/RS-232): transmitting data⁽²⁾
- G. Link (Ethernet 1 link): user Ethernet connection

Table 3-2: CPU Module labeling and LED functions

CPU Module label or LED	Function	Switch position indicator or LED
WRITE PROT.	<ul style="list-style-type: none"> • Write-protect mode - with switch in the ON position (default setting) protects configuration and firmware overwrites. • To write configuration changes or download firmware to the meter change the switch to the OFF position. 	Switch position <ul style="list-style-type: none"> • ON - (default setting) enables write protection of the configuration and firmware • OFF - enables writing configuration changes or downloading firmware
DHCP	<ul style="list-style-type: none"> • Dynamic Host Protocol Server - enables you to communicate with a Rosemount meter that is not connected to a network. • When the CPU Module switch is in the ON position, the meter is enabled to act as a DHCP server for a single DHCP client connected to the Ethernet port using a crossover cable. This should be used for peer to peer connections only. • When the connection is made, select to use the Meter Name in the meter instead of the Meter Directory Name in order to keep all log files and configurations separate from each meter. 	Switch position <ul style="list-style-type: none"> • ON - the meter is enabled to act as a DHCP server for a single DHCP client • OFF - disables the DHCP server

⁽²⁾ For RS-485 two-wire, use TX+ and TX-.

Table 3-2: CPU Module labeling and LED functions (continued)

CPU Module label or LED	Function	Switch position indicator or LED
PORT A	<ul style="list-style-type: none"> • PORT A override - RS-232 serves as an override during meter commissioning to establish communications and in the event the user cannot communicate with the meter due to an inadvertent communication configuration change. The override period is for two minutes. • Supports: <ul style="list-style-type: none"> — auto-detected ASCII (Start bit 1, Data Bit 7, Parity Odd/Even, Stop Bit 1) — RTU (Start Bit 1, Data Bit 8, Parity none, Stop Bit 1) — Modbus protocols • RS-232 Baud rate=19,200 • Modbus ID=32 	Switch position <ul style="list-style-type: none"> • ON - enables RS-232 PORT A override • OFF - (default setting) disables RS-232 PORT A override
MEAS	System color indicates metrology mode <ul style="list-style-type: none"> • Acquisition mode • Measurement mode 	LED status <ul style="list-style-type: none"> • Red flashing LED, the meter is in acquisition mode. • Solid red, the Acquisition Module is not communicating with the CPU Module. • Solid green LED, the meter is in measurement mode.
PWR	<ul style="list-style-type: none"> • 3.3 V Power Indicator 	<ul style="list-style-type: none"> • Solid green
LED 4	<ul style="list-style-type: none"> • Indicates link between CPU and acquisition module 	<ul style="list-style-type: none"> • Solid green
LED 5	<ul style="list-style-type: none"> • Indicates communication between CPU module and acquisition module 	<ul style="list-style-type: none"> • Solid green
RX	<ul style="list-style-type: none"> • RX signal (Port A for RS485 or RS232 communication) receiving data 	<ul style="list-style-type: none"> • Flashing green (when receiving data)
TX	<ul style="list-style-type: none"> • TX signal (Port A for RS485; 2-wire or 4-wire or RS232 communication) transmitting data 	<ul style="list-style-type: none"> • Flashing green (when transmitting data)
Link	<ul style="list-style-type: none"> • ETH1Link user Ethernet connection 	<ul style="list-style-type: none"> • Solid green, when link is established.

Ethernet communications

The Ethernet port IP address, subnet mask, and gateway address are software-configurable. In addition, a meter can be configured to act as a DHCP (Dynamic Host

Configuration Protocol) server to assign an IP address to a PC or laptop running MeterLink. The DHCP server facility is not intended to act as a general purpose DHCP server for a wider network. To this end, no user control is provided over the class or range of IP addresses the unit provides. A standard twisted pair (Cat-5) cable should be used for Ethernet wiring.

It is strongly recommended that the meter be configured using an independent (off-network) single host. After configuration of the Rosemount™ 3410 Series Gas Ultrasonic Flow Meter, the DHCP option must be turned off if used on a LAN/WAN.

NOTICE

Restricted Ethernet and serial connectivity usage

Failure to restrict Ethernet and communication access to the 3410 Series Gas Ultrasonic Flow Meter can result in, among other things, unauthorized access, system corruption, and/or data loss.

User is responsible for ensuring that physical access and Ethernet or electronic access to the 3410 Series Gas Ultrasonic Flow Meter is appropriately controlled and any necessary security precautions are implemented; such as, establishing a firewall, setting password permissions and/or implementing security levels.

Table 3-3: Ethernet cable to PC communication

Ethernet communication	
Wire color	CPU
White w/Green Stripe	TX+
Solid Green	TX -
White w/Orange Stripe	RX+
Solid Orange	RX -

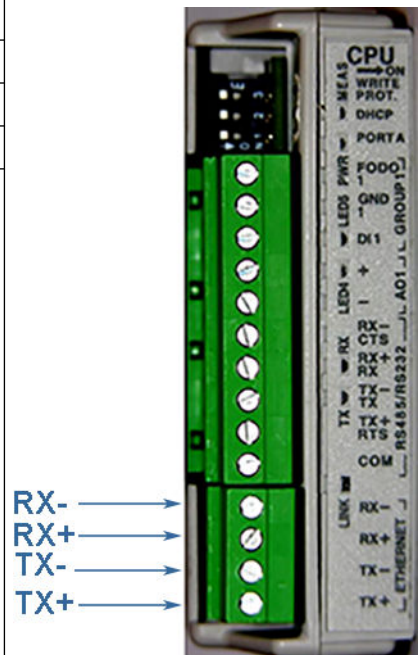

The diagram shows a 48-pin connector with a green plastic cover. Four blue arrows point to the pins from left to right, labeled RX-, RX+, TX-, and TX+. The connector is part of a larger module with various other labels like CPU, MEAS, WRITE PROT., DHCP, PORT A, FODD, GND, DI1, AO1, J.L. GROUP 1, RS485/RS232, COM, LINK, and ETHERNET.

Use Ethernet cable, Rosemount P/N 1-360-01-596, to connect the PC to the meter.

A DIN 41612 48-pin connector is the interface from the CPU Module to the Field Connection Board (male end located on the back of the Field Connection Board).

Cybersecurity and network communications

In order to mitigate cybersecurity risks, configure the 3410 electronics TCP/IP communications as follows:

1. MeterLink™ uses either FTP or HTTP protocols for Archive and Smart Meter Verification log collection. It is recommended to disable the FTP protocol and leave the HTTP protocol enabled using the **Meter** → **Communications Settings** dialog in MeterLink. Both can be disabled for additional security, but log collection will not be possible in this configuration.
2. Leave the Telnet port disabled. This port is not required for any communications to field devices or MeterLink. Beginning with Rosemount 3410 Series Firmware v1.60, Telnet is permanently disabled.
3. Enabling the physical Write Protect switch will prevent metrology configuration changes and firmware upgrades. It will also prevent enabling TCP/IP protocols such as FTP, HTTP, and Telnet.
4. Disable unused protocols or set them to read-only if write capability is not required. The Modbus TCP/IP protocol can be set to Read-only or Disabled on the Ethernet port. Modbus protocols can be disabled or made read-only on serial ports while still allowing authenticated MeterLink communications.
5. Rosemount 3410 Series Firmware v1.60 and later require user authentication and has a default administrator password. While the password is unique to each meter, it is highly recommended to be changed at meter startup. For added security, the default username, administrator, can be changed as well.
6. Other users can be added with different privileges and passwords in the Rosemount 3410 Series Firmware v1.60 and later. Only give users privileges to perform their job functions. For more information, see [Manage users](#) on how to add, change, and delete users.

This transmitter:

1. Is not intended to be directly connected to an enterprise or to an internet facing-network without a compensating control in place.
2. Must be installed following industry best practices for cybersecurity.

Modbus TCP

If the meter firmware supports Modbus TCP slave functionality, the following controls will be available.

Modbus TCP unit identifier: Enter the Modbus TCP unit identifier here. Valid values are 0-255.

Enable alternate Modbus TCP port: The standard TCP port for Modbus TCP is port 502. This port is always enabled in a meter that supports Modbus TCP. By selecting this option, you can also enable Modbus TCP communications on a secondary TCP port specified by Alternate Modbus TCP port.

Alternate Modbus TCP port: Enter the alternate TCP port number here after selecting Enable alternate modbus TCP port. Valid port numbers are from 1 to 65535. The meter will not allow some port numbers that are either used by the meter or are defined port numbers for other protocols. MeterLink™ will prompt you if it was not able to write the specified port number to the meter.

Serial connections

Use a serial cable, Rosemount™ P/N 3-2500-401, to connect to a PC running MeterLink. The cable is designed for RS-232 communications which is the serial Port A default configuration (see [Rosemount 3410 Series engineering drawings](#) field wiring diagram, Rosemount Drawing DMC-005324). The DB-9 end of the cable plugs directly into the PC running MeterLink. The three wires on the other end of the cable connect to the CPU

Module RS-485/RS-232 terminals. The RED wire goes to RX, the WHITE wire goes to TX, and the BLACK wire goes to COM (see [Figure 3-9](#) for Port A wiring). RS-485, 2-wire connection on Port A, uses TX+ and TX- on the CPU Module and has a ground wire.

When Beldon wire No. 9940 or equivalent is used, the maximum cable length for RS-232 communications at 9600 bps is 88.3 meters (250 ft.) and the maximum cable length for RS-485 communication at 57600 bps is 600 meters (1970 ft.).

Port A supports a special override mode which forces the port to use known communication values (19200 baud, address 32, RS-232). Note that the protocol is auto-detected. This mode is expected to be used during meter commissioning (to establish initial communication) and in the event that the user cannot communicate with the meter (possibly due to an inadvertent communication configuration change). Alternately, when using MeterLink™ with an Ethernet port, use Ethernet cable, Rosemount P/N 1-360-01-596, to connect the PC.

Each serial port can be independently configured as read only in meter serial connection settings. Read only serial ports prevent write access, program downloads, alarm acknowledgements and testing of outputs. The read only serial port setting is configurable through **Edit** → **Compare Page** by modifying configuration point ReadWriteModePortA, B or C, and changing to Read-only mode.

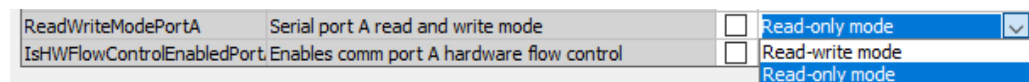

Serial ports configured as read-only will not allow modification to the configuration regardless of the state of the Write Protect switch. MeterLink will display a message stating “The meter’s serial port is read-only” if a write to configuration is rejected. Similar messages will be displayed when other functionality is rejected due to port configured as read-only.

Serial ports configured as read-only will reject Modbus write requests (function codes 06h and 10h) and return error code 03h (Illegal data value).

Table 3-4: Serial Port A parameters

Port/ Communication	Description	Common features
Port A (Standard) <ul style="list-style-type: none"> • RS-232 • RS-485 Half Duplex • RS-485 Full Duplex • RS-485 ⁽¹⁾ (2-wire communication on Port A) 	<ul style="list-style-type: none"> • Typically used for general communications with a flow computer, RTU (Modbus slave) and radios. • RS-485 - 2-wire (Half Duplex) connected to TX+ and TX- • Special override mode to force port configuration to known settings. • Supports RTS/CTS handshaking with software- configurable RTS on/off delay times. • Factory default is RS-232, Address32, 19200 baud 	<ul style="list-style-type: none"> • Communications via MeterLink using RS-232 or RS-485 Full Duplex • Software configurable Modbus Address (1-247) • Auto-detects TCP/IP and ASCII or RTU Protocol <ul style="list-style-type: none"> — ASCII Protocol: <ul style="list-style-type: none"> • Start Bits = 1, Data Bits = 7 ⁽²⁾ — Parity: odd or even 1, Stop Bits = 1⁽²⁾ — Baud Rates: 1200, 2400, 9600, 19200, 38400, 57600, 115000 bps — RTU Protocol: <ul style="list-style-type: none"> • Start Bits = 1, Data Bits = 8⁽²⁾ — Parity: odd or even 1, Stop Bits = 1⁽²⁾ — Baud Rates: 1200, 2400, 9600, 19200, 38400, 57600, 115000 bps • Each port is software configurable as Read-only.
Ethernet	<ul style="list-style-type: none"> • Preferred port for diagnostic communication via MeterLink • 10 Mbps/100 Mbps 	<ul style="list-style-type: none"> • 10 Mbps/100 Mbps

(1) RS-485 2-wire connections use TX+ and TX - on the CPU Module.

(2) Denotes auto-detected protocols.

NOTICE

If not using Ethernet, a full duplex serial connection is necessary for MeterLink to communicate with a 3410 Series Gas Ultrasonic Meter.

Figure 3-9: PC to meter serial connection wiring

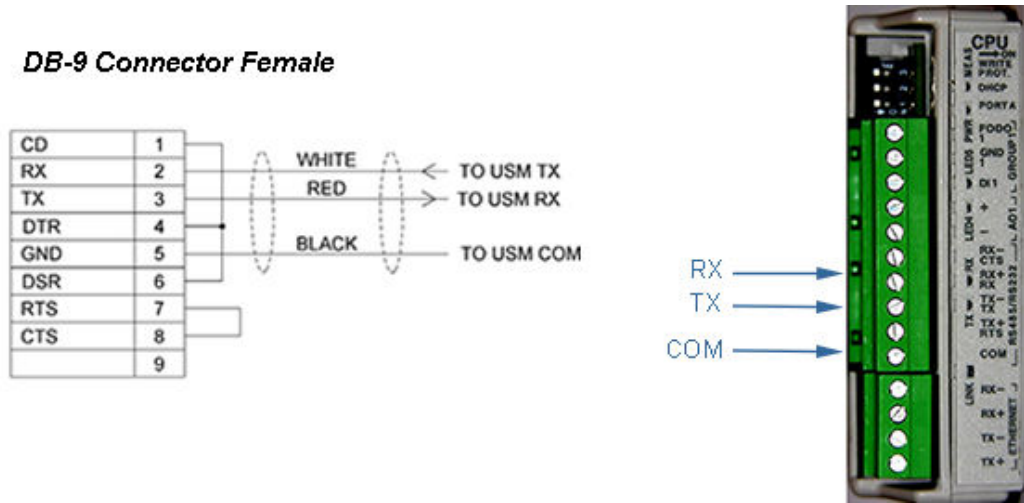

3.5.2 Input/output connections

The Rosemount 3410 Series Gas Ultrasonic Flow Meter provides the I/O connections on the CPU Module.

Figure 3-10: CPU Module I/O connections

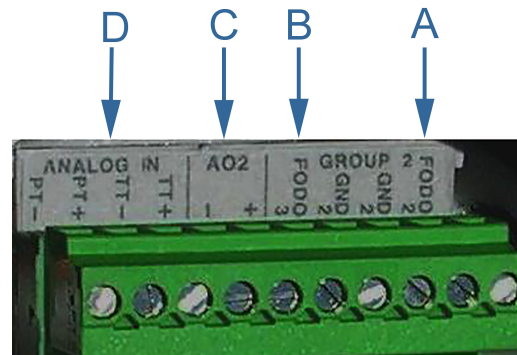

- A. Frequency/digital output 2
- B. Frequency/digital output 3
- C. Analog output 2: 4-20 mA output
- D. Analog input: temperature and pressure connections

Figure 3-11: CPU Module I/O connections - Type 4

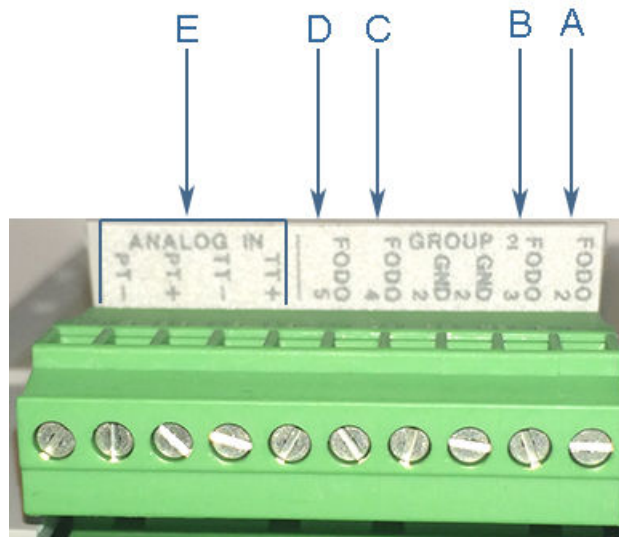

- A. Frequency/digital output 2
- B. Frequency/digital output 3
- C. Frequency/digital output 4
- D. Frequency/digital output 5
- E. Analog input: temperature and pressure connections

Optional input and output modules

These modules are plugged into the second or third slot (retrofit) on the electronics head. These module options consist of an RS-232, RS-485 serial port modules or Expansion I/O Module. Expansion I/O Module should only be used with Type 4 CPU Module (1-360-03-065).

These modules allow expanding I/O capabilities of the meter to include extra serial ports. There are three options currently available. Serial RS-232 without handshaking, serial RS-485 Half-duplex, or RS-232/RS/485, with 3 port Ethernet Switches. For the standard enclosure offering, one serial module can be added. This serial module would become Port B. For users with retrofit enclosure option, then two serial modules can be added. These serial modules would be designated Port B and Port C based on slot installed.

Figure 3-12: Optional module RS-232

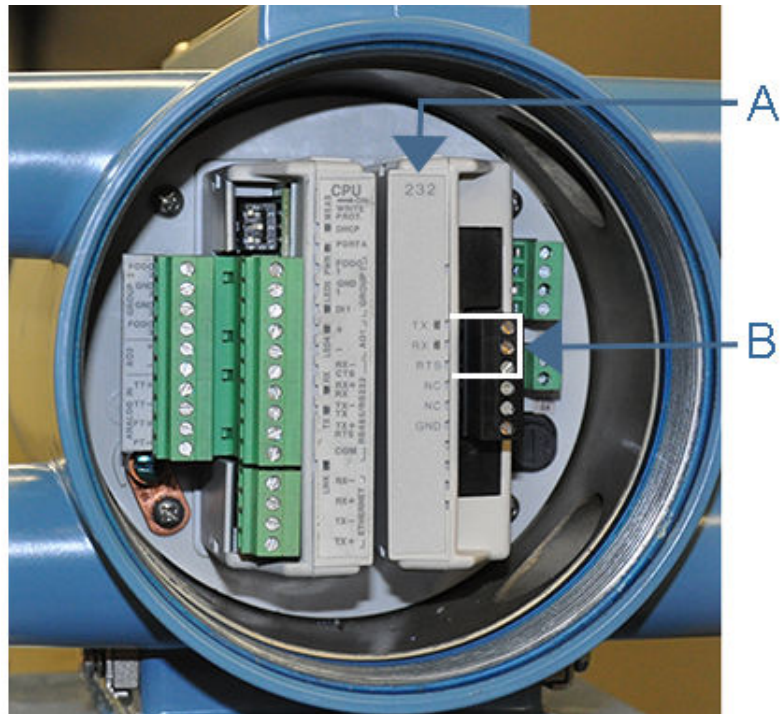

- A. Serial COMs (RS-232)
- B. RS-232: RTS, TX, RX

Figure 3-13: Optional module RS-485

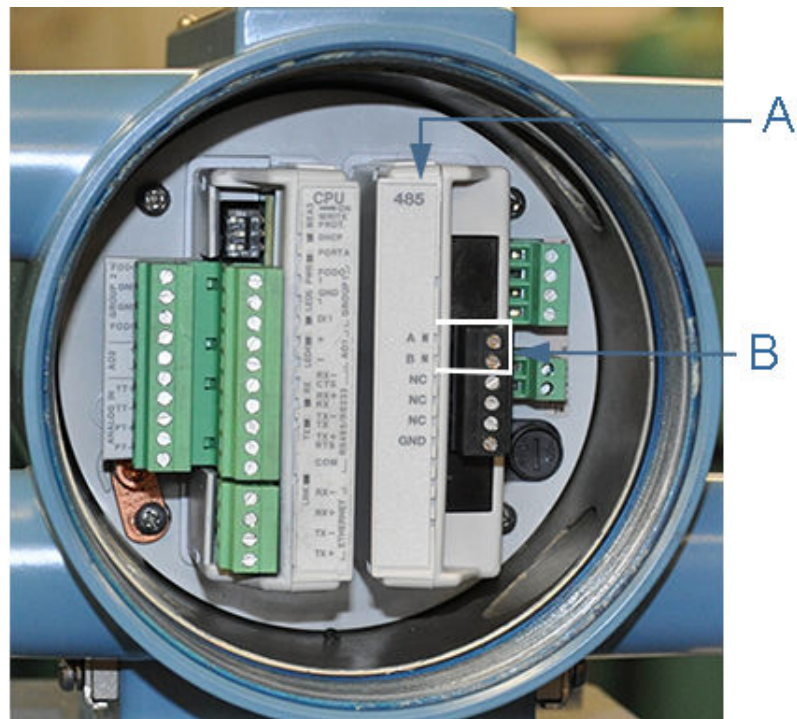

- A. Serial COMs (RS-485)
- B. RS-485: TX+, TX- (two-wire half duplex)

Figure 3-14: Optional Expansion I/O Module

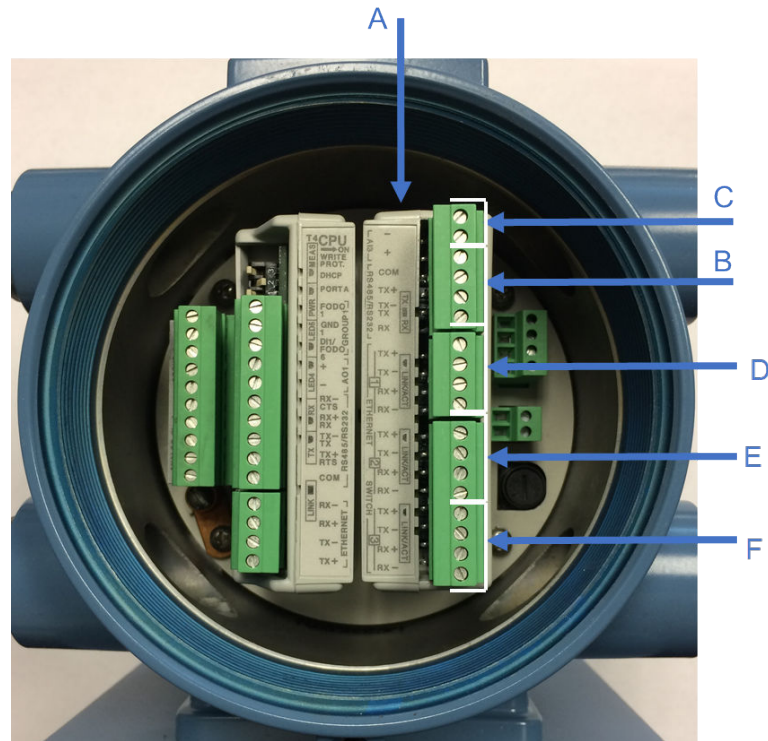

- A. Expansion I/O Module
- B. RS-232: RX, TX, COM/RS-485: TX+, TX- (2-wire Half Duplex)
- C. 4-20 mA Input - AI3+/- (future use)
- D. Ethernet port 1 switch
- E. Ethernet port 2 switch
- F. Ethernet port 3 switch

Table 3-5: Expansion I/O to RJ45 wiring

Ethernet communication	
Wire color	CPU/EXP
White w/Green Stripe	TX+
Solid Green	TX-
White w/Orange stripe	RX+
Solid orange	RX-
<p>Note Wiring colors for TX+/TX- and RX+/RX- can be switched as ethernet ports will automatically detect crossover vs. straight connection. Connections shown are for straight through cable.</p>	

Figure 3-15: PC to meter serial connection wiring - RS-232

DB-9 Connector Female

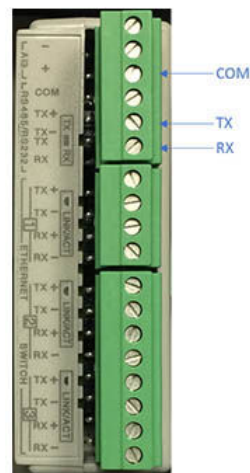
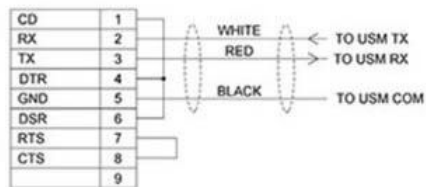
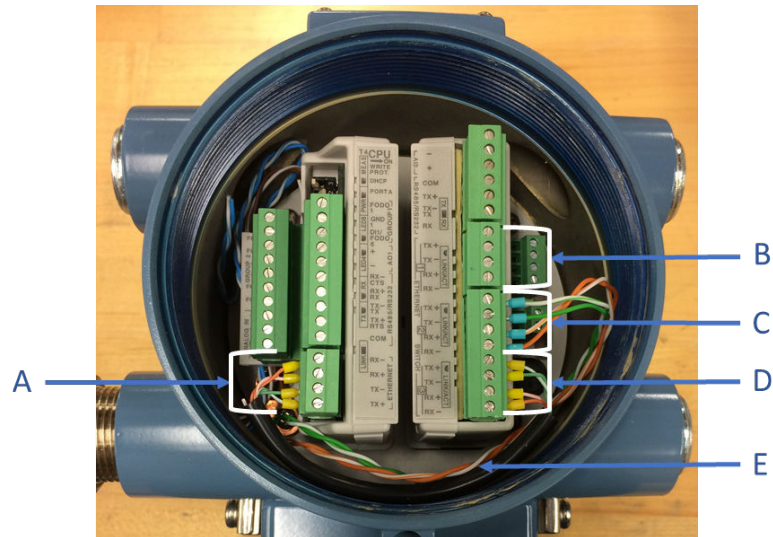

Figure 3-16: Transmitter Head with Expansion I/O Module



- A. Ethernet connection from expansion I/O module
- B. Ethernet connection available for user connection
- C. Ethernet connection from central processing unit (CPU) module
- D. Expansion I/O Ethernet cable for connection between CPU and expansion I/O (PN 1-360-03-058)

Table 3-6: Optional modules parameters

	Description	Common features
Port B/Port C (Optional module) <ul style="list-style-type: none"> • RS-232 - P/N: 1-360-024 • RS-485 Half Duplex - P/N 1-360-03-023 • Expansion I/O Module - P/N 1-360-03-026 (232/485 Half Duplex, Ethernet switch) 	<ul style="list-style-type: none"> • Typically used for general communications with a flow computer, RTU (Modbus slave) and radios. • RS-485 - 2-wire (Half Duplex) connected to TX+ and TX- (P/N 1-360-03-026) or A and B (P/N 1-360-03-023) • Factory default is RS-232, Address32, 19200baud 	<ul style="list-style-type: none"> • Communications via MeterLink using RS-232 • Software configurable Modbus Address (1-247) • Auto-detects TCP/IP and ASCII or RTU Protocol <ul style="list-style-type: none"> — ASCII Protocol: <ul style="list-style-type: none"> • Start Bits = 1, Data Bits = 7⁽¹⁾ — Parity: odd or even 1, Stop Bits = 1⁽¹⁾ — Baud Rates: 1200, 2400, 9600, 19200, 38400, 57600, 115000 bps — RTU Protocol: <ul style="list-style-type: none"> • Start Bits = 1, Data Bits = 8⁽¹⁾ — Parity: odd or even 1, Stop Bits = 1⁽¹⁾ — Baud Rates: 1200, 2400, 9600, 19200, 38400, 57600, 115000 bps • Software configurable as Read-only
Note Port C is only available with Retrofit Enclosure.		

(1) Denotes auto-detected protocols.

Note

Use of FODO6 requires DI1Mode set to Frequency/Digital Output 6. Digital Input will not be available.

Figure 3-17: Expansion I/O LED indicators

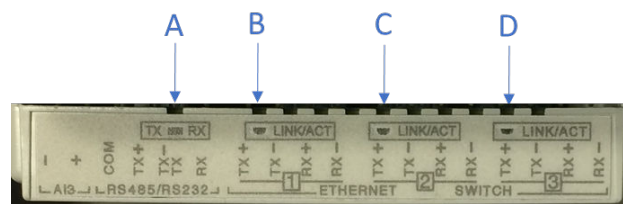

- A. TX/RX for RS-232/RS-485 serial port: Flashing (orange - RX/green - TX)
- B. Ethernet switch port 1: link/activity indicator. Flashing (green)
- C. Ethernet switch port 2: link/activity indicator. Flashing (green)
- D. Ethernet switch port 3: link/activity indicator. Flashing (green)

Table 3-7: Expansion I/O LED functions

Expansion I/O Module LED	Function	LED
TX/RX	RX/TX signal (Port B/C for RS485 or RS232 communication) receiving and transmitting data	<ul style="list-style-type: none"> Flashing Orange - RX Flashing Green - TX
LINK/ACT		
Ethernet Switch Port 1, 2, 3	<ul style="list-style-type: none"> Link and Activity indicator for each Ethernet switch port Separate indicator for each Ethernet switch port 	Flashing Green when Ethernet activity present

Frequency/Digital outputs

The meter has three user-configurable outputs that can be configured for either a Frequency output or Digital output (FODO).

- FODO1 (eight possible parameter configurations) [Type 2] [Type 4]
- FODO2 (eight possible parameter configurations) [Type 2] [Type 4]
- FODO3 (eight possible parameter configurations) [Type 2] [Type 4]
- FODO4 (eight possible parameter configurations) [Type 4]
- FODO5 (eight possible parameter configurations) [Type 4]
- FODO6 (eight possible parameter configurations) [Type 4]
 - (DI1Mode must be set to Frequency/Digital Output 6 to enable FODO6)

Frequency or Digital Outputs (FODO1, FODO6) source options ~ Group 1

- FO1A, DO1A, FO1B, DO1B, FO2A, DO2A, FO2B, DO2B
- Frequency output 1A is the A Phase of Frequency output 1 content (Uncorrected volume flow rate, Corrected volume flow rate, Average flow velocity, Average speed of sound, Energy flow rate, Mass flow rate)
- Frequency output 1B is the B Phase of Frequency output 1
- Frequency output 2A is based on frequency content (Actual - Uncorrected Flow Rate)
- Frequency output 2B is based on frequency content and Frequency 2B Phase
- Digital output 1A is based on Digital output1A content (Frequency Output 1Validity, Flow Direction, Process Validity)
- Digital output 1B is based on Digital output1B content (Frequency Output 1Validity, Flow Direction, Process Validity)
- Digital output 2A is based on Digital output 2A content (Frequency Output 1Validity, Flow Direction, Process Validity)
- Digital output 2B is based on Digital output 2B content (Frequency Output 1Validity, Flow Direction, Process Validity)

Frequency or Digital Outputs (FODO2, FODO3, FODO4, FODO5) source options ~ Group 2

- FO1A, DO1A, FO1B, DO1B, FO2A, DO2A, FO2B, DO2B

- Frequency output 1A is the A Phase of Frequency output 1 content (Uncorrected volume flow rate, Corrected volume flow rate, Average flow velocity, Average speed of sound, Energy flow rate, Mass flow rate)
- Frequency output 1B is the B Phase of Frequency output 1
- Frequency output 2A is the A Phase of Frequency output 2 content (Uncorrected volume flow rate, Corrected volume flow rate, Average flow velocity, Average speed of sound, Energy flow rate, Mass flow rate)
- Frequency output 2B is the B Phase of Frequency output 2 content
- Digital output 1A is based on Digital output1A content (Frequency Output 1Validity, Flow Direction, Process Validity)
- Digital output 1B is based on Digital output1B content (Frequency Output 1Validity, Flow Direction, Process Validity)
- Digital output 2A is based on Digital output 2A content (Frequency Output 1Validity, Flow Direction, Process Validity)
- Digital output 2B is based on Digital output 2B content (Frequency Output 1Validity, Flow Direction, Process Validity)

Mode options

- Open Collector (requires external excitation supply voltage and pull-up resistor)
- TTL (internally powered by the meter 0-5 Vdc signal)

Channel B Phase options

- Lag forward, Lead reverse (Phase B lags Phase A while reporting forward flow, leads Phase A while reporting reverse flow)
- Lead forward, Lag reverse (Phase B leads Phase A while reporting forward flow, lags Phase A while reporting reverse flow)

Phase A and Phase B output (based on flow direction)

- Reverse flow - output only reports flow in the reverse direction. For frequency outputs, Phase B of the output is 90 degrees out of phase with Phase A.
- Forward flow - output only reports flow in the forward direction. For frequency outputs, Phase B of the output is 90 degrees out of phase with Phase A.
- Absolute - output reports flow in both directions. For frequency outputs, Phase B of the output is 90 degrees out of phase with Phase A.
- Bidirectional - output reports flow on Phase A only in the forward direction and on Phase B only in the reverse direction.

Maximum frequency for the frequency outputs

- 1000 Hz
- 5000 Hz

Frequency/Digital output		Source configuration
Frequency /Digital Output 1 Frequency /Digital Output 2 Frequency /Digital Output 3 Frequency /Digital Output4 Frequency /Digital Output 5 Frequency /Digital Output 6	<ul style="list-style-type: none"> • Frequency output 1A • Frequency output 1B • Digital output 1A • Digital output 1B • Frequency output 2A • Frequency output 2B • Digital output 2A • Digital output 2B 	

Output for FODO1 and Digital Input 1 or FODO6 (Type 4 CPU) (Group 1 on the CPU Module) share a common ground and have 50 V isolation. FODO2, FODO3, FODO4 (Type 4 CPU), and FODO5 (Type 4 CPU) (Group 2 on the CPU Module) share a common ground and have 50 V isolation. This allows an output to be connected to a different flow computer. The outputs are opto-isolated from the CPU Module and have a withstand voltage of at least 500V rms dielectric.

Figure 3-18: CPU Module - Frequency/Digital outputs common ground - Type 2

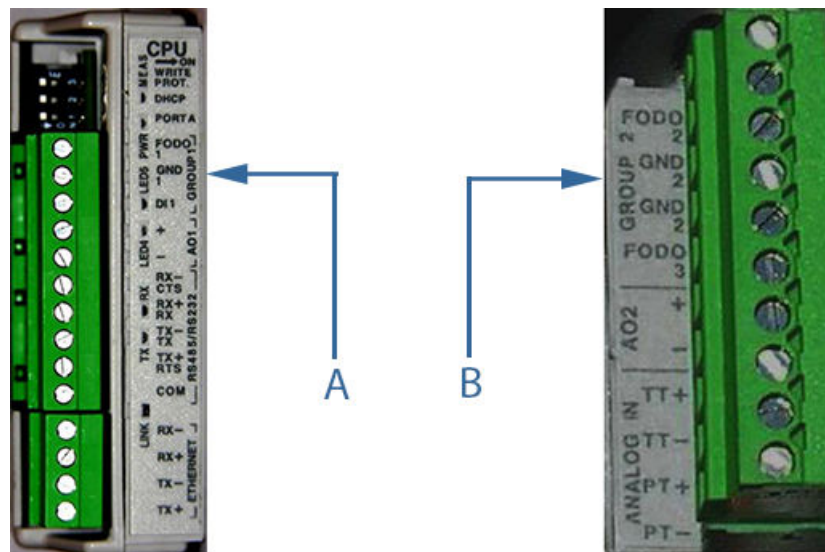

- A. FODO1 and digital input 1: shared common ground (group 1)
B. FODO2 and FODO3: shared common ground (group 2)

Figure 3-19: CPU Module - Frequency/Digital outputs common ground - Type 4

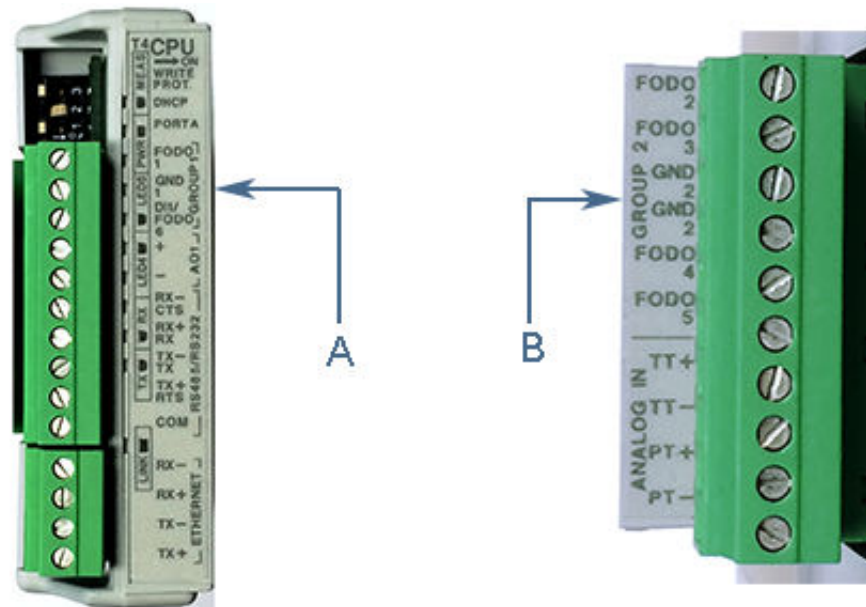

- A. FODO1 and DI1/FODO6: shared common ground - Type 4 CPU module (group 1)
 B. FODO2, FODO3, FODO4, and FODO5: shared common ground - Type 4 CPU module (group 2)

Analog input settings

The Rosemount 3410 Series Gas Ultrasonic Flow Meter has the capability to sample analog temperature (Analog Input 1) and pressure (Analog Input 2) with 4-20 mA signals. These analog input signals are configured to sink. The two independent analog input circuits are configured for conventional 4-20 mA service. Also, 24 Vdc isolated power supply connection is provided for an external power source. Refer to the Field wiring diagram DMC-005324 in [Rosemount 3410 Series engineering drawings](#).

Analog output settings

The Rosemount 3410 Series Ultrasonic Gas Flow Meter provides 4-20 mA analog output signals that are software configurable for either sink or source current (see [Rosemount 3410 Series engineering drawings](#), DMC-005324).

- Analog Output 1 (AO1) is user-configurable as a 4-20 mA output
- Analog Output 2 (AO2) is user-configurable as a conventional 4-20 mA output - Type 2 CPU Module only

Digital input

The Rosemount 3410 Series Gas Ultrasonic Flow Meter provides one digital input that can be used as a general purpose input. The digital input must be configured via the MeterLink **Tools | Edit** → **Compare Configuration** screen. DI1Mode must be set to Digital Input/Calibration Input.

DHCP server switch settings

The meter can be configured to act as a DHCP server. The DHCP server is enabled/disabled via **CPU Module DHCP** switch as follows:

Table 3-8: DHCP server switch settings

CPU Module switch	DHCP server disabled	DHCP server enabled
 <p>DHCP Switch 2</p>	OFF	ON

Configuration protect switch settings

The meter's configuration parameters and firmware can be protected against changes via the CPU Module **WRITE PROT.** switch as follows:

Table 3-9: Configuration protect switch settings

CPU Module switch	Configuration protected	Configuration unprotected
 <p>WRITE PROT. Switch 3</p>	ON (default setting)	OFF

External power source connection and fuse

Located inside the transmitter electronics enclosure is a connector for a user-provided external power source, a 2 amp fuse and a 24 V loop power connection for ultrasonic meter analog outputs, temperature transmitter or pressure transmitter devices. The current is limited to 88 mA.

Figure 3-20: CPU Module power source connections

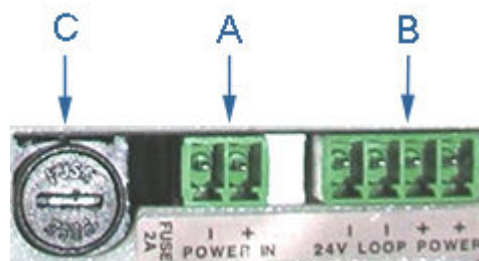

- A. Power in connector (main power)
- B. 24 V loop power
- C. 2 amp fuse (used for main power input)

3.6 Security seal installation

Security seals protect the integrity of the meter metrology and prevent tampering with transducer assemblies. The following sections detail how to properly seal the Rosemount

3410 Series Gas Ultrasonic Flow Meter after commissioning. The security seal wires are commercially available.

Prior to sealing the enclosure, ensure that the **WRITE PROT.** switch is set on the CPU Module to the **ON** position.

3.6.1 Seal transmitter electronics enclosure

Use the following instructions to install the security seal wires on the Transmitter Electronics Enclosure.

Figure 3-21: Transmitter electronics enclosure security latch

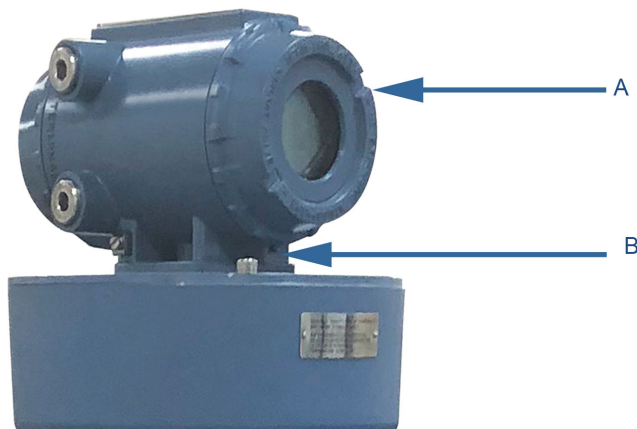

- A. Transmitter electronics enclosure end cap
- B. Security latch

Procedure

1. Rotate the endcaps clockwise fully closing and compressing the end cap seal. Install the Security latch for each endcap using a 3 mm Allen wrench.
2. Install the security seal wire into and through one of the two holes in the end cap.
 - a) Choose holes that minimize counterclockwise rotation of the end cap when the security wire is taut (maximum wire diameter 0.078-in.; 2.0 mm).

Figure 3-22: Transmitter electronics enclosure security seals

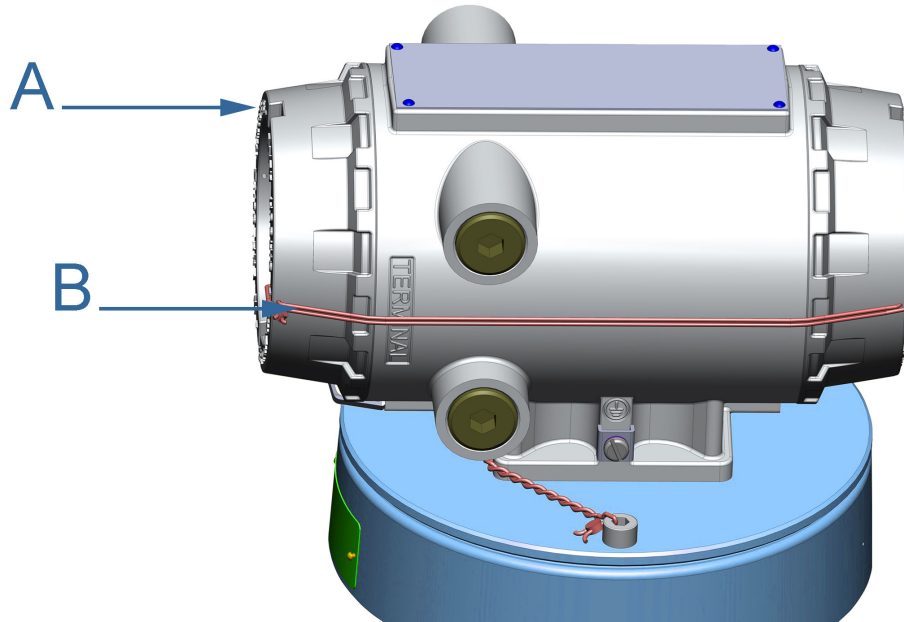

- A. Transmitter electronics enclosure end cap
- B. Security wire seals

3. Adjust the security wire, removing all slack and thread into the lead seal.
4. Crimp lead seal and cut wire ends to remove excess wire.

3.6.2 Base enclosure security seals

Use the following instructions to install the security seal wire on the Base Enclosure.

Procedure

1. Install security wire seal into and through the hole in the socket head screw on the Base Enclosure cover (maximum wire diameter .078-in.; 2.0 mm).

Figure 3-23: Base enclosure wire seal installation

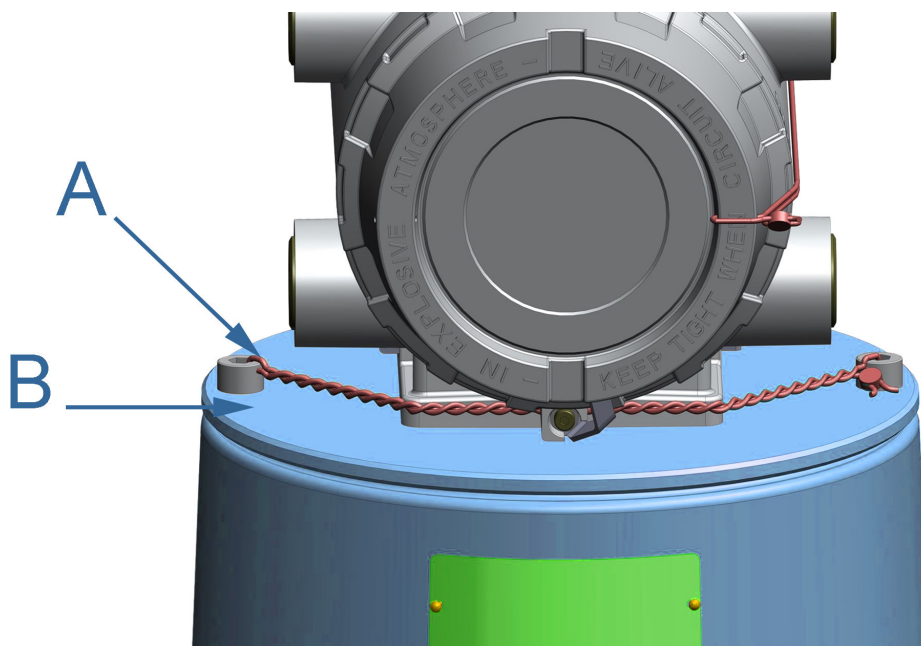

- A. Security wire seals
- B. Base enclosure cover

2. Position the wire to prevent counterclockwise rotation of the screws when the seal wire is taut.
3. Feed the security wire beneath the Transmitter Electronics Enclosure and through the adjacent socket head screw. Twist the wire, removing all slack and seal.
4. Cut wire ends to remove excess wire.

3.6.3 Transducer assembly security seal

The transducer assemblies can be protected from tampering by securing the shrouds over the transducers with wire seals as follows:

Procedure

1. Locate the shroud pin on the meter body. This pin will hold the appropriate shroud in place while the mating side is brought into place.

Figure 3-24: Latch pin and Shroud recesses

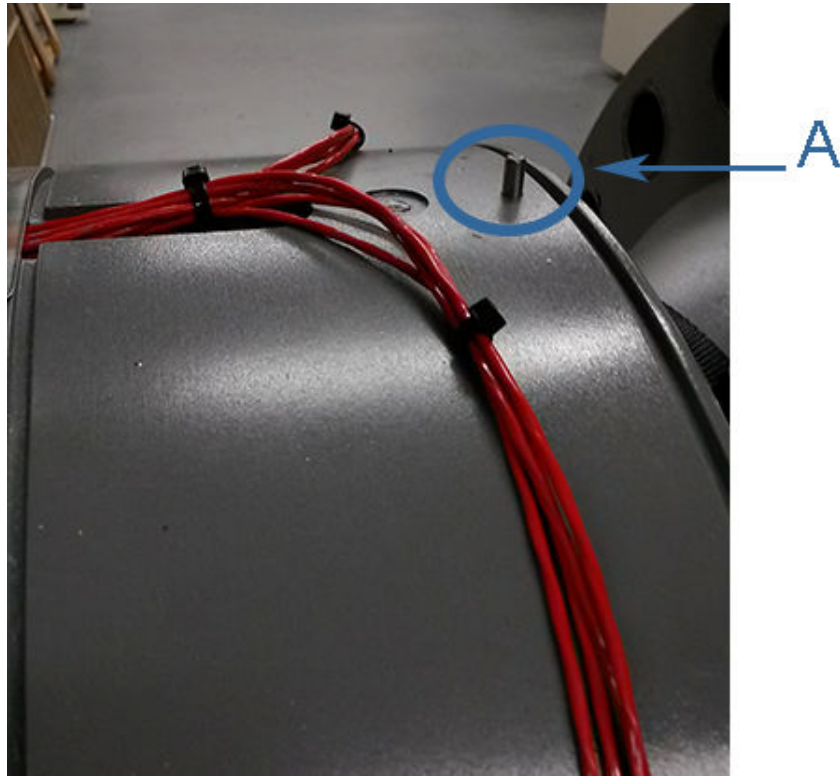

A. Shroud pin on meter body

2. Hook the appropriate shroud over the pin, ensuring the transducer cabling is within the shroud. Care needs to be taken not to pinch the cables between the shroud recesses and shroud as the shroud is fitted into place. Once the shroud is snugly seated in these recesses it will hang on the pin for ease of attaching its mating pair.

Figure 3-25: Shroud hanging on Shroud pin



3. Bring up the mating shroud, ensuring the transducer cabling falls within and is snug in the shroud recess as before and hold in place.
4. Latch first the bottom shroud latch(s) followed by those on the upper side of the shroud.
5. Thread the security seal's wire through the holes found on the latching lever side of the mechanism and then through the seal mechanism itself. Pull the wire taught then rotate the cranking tab until it snaps off.

Figure 3-26: Shroud latch with Security seal



6. Check that the seal is properly fitted to prevent the latch from lifting. Verify the latch is secure and clip off any extra wire extending from the seal.

3.7 Sealing the unit

The unit should be properly sealed after electrical connections have been tested according to the customer's Best Practices schedule. Some areas require a witnessed Acceptance Test for the installed system and require that the meter run for a predetermined length of time (approximately one to two weeks) before the unit is sealed. This allows time to verify all electrical connections are correct, that the meter is accurately measuring flow and that the meter meets the customer's installation requirements. See [Start-up for systems that use explosion-proof conduit](#) and [Start-up for systems that use flame-proof cable](#).

4 Configuration

After the mechanical and electrical installation has been completed, use the following to install MeterLink™ in order to establish connection with the meter to perform final configuration and verify meter performance.

4.1 Set up the MeterLink™

Procedure

1. Follow the instructions in the [MeterLink™ Software for Gas and Liquid Ultrasonic Meters Quick Start Manual](#) to setup software communications with the meter.
2. Select **File** → **Program Settings** and customize the user-preferences (e.g. User name, Company name, display units, Liquid Meter volume units and other interface settings).
3. Connect to your meter. If your meter is not shown in the list, select **Edit Meter Directory** and setup the connections properties.
4. Save the meter configuration file, collect a Maintenance log and Waveforms to document the meter's "As Found" settings.
5. Run the Field Setup Wizard.

4.2 Field Setup Wizard

Procedure

1. Use the Field Setup Wizard-Startup in MeterLink™ to select the check boxes that allow proper configuration for your meter (Temperature, Pressure, Meter Corrections, Meter Outputs, Gas chromatograph setup, Continuous flow analysis and View local display setup).
Selections on this page will affect other configuration selections.
2. Select **Next** to continue to General setup.
3. Use General setup to configure the meter's units system (U.S Customary or Metric units) volume units, flow rate time, low flow cutoff, contract hour, enable reverse flow alarm, set meter time and notepad comments.

Note

The Meter's Units system configured on the General Page affect the units for the optional Local Display items.

4. Select **Next** to continue to Frequency/Digital Outputs page.
5. Set the Frequency/Digital Outputs Sources for either a frequency output or a digital status.
 - a) Select the Source for each Frequency/Digital output and select the desired drive Mode. The Mode options are Open Collector which requires an external excitation voltage and pull-up resistor or TTL mode which outputs a 0-5 Vdc signal.
 - b) Select **Next** to continue to Frequency Outputs page.

6. Note

Frequency outputs 1 and Digital outputs 1 are paired together. This then means that the Digital outputs 1 will be set to report the status for the parameter for Frequency

outputs 1. Similarly, Frequency outputs 2 and Digital outputs 2 are paired together. Additionally, each Frequency output has an A and B output phase.

Configure Frequency output 1 and Frequency output 2 content, flow direction, Channel B phase, maximum frequency output (Hertz) and full scale volumetric flow rate.

7. Select **Next** to continue to Meter Digital Outputs.
8. Select the Meter Digital Output parameters for Digital output 1A, Digital output 1B, Digital output 2A and Digital output 2B based on Frequency validity or flow direction.

If the output of the ultrasonic meter is reversed from what a flow computer is expecting, select **Inverted Operation**. This changes the digital output from a HIGH for a TRUE condition to output a LOW for a TRUE condition.

9. Select **Next** to continue to Analog Outputs.
10. Configure Analog Outputs.
Analog outputs can be based on Uncorrected volume flow rate, Corrected volume flow rate, Average flow velocity, Average speed of sound, Energy flow rate or Mass flow rate. The flow direction (Forward, Reverse or Absolute) and Full scale volumetric flow rate used with output (20mA maximum) are also configurable.
Alarm action parameters determines the state the output will drive during an alarm condition (High 20 mA, Low - 4 mA, Hold last value, Very low - 3.5, Very high 20.5 mA or None).

11. Select **Next** to continue to the Meter Corrections page.
12. The Meter Corrections page is used to define parameters for pressure and temperature expansion correction of the meter internal diameter if enabled. Click **Next** to continue to the Temperature and Pressure page.
13. Set the temperature and pressure scaling for analog inputs, enter fixed values, and set alarm limits for both. The alarm limit selections are hold last output value or use fixed value.
14. Click **Next** to continue to the Gas Chromatograph Setup page.
15. Select the settings below to configure USM device as a Modbus Master to poll a gas chromatograph. See [Serial connections](#) to configure port as Read-only.
 - **Port:** Select which serial port will be connected to the GC. While the port is configured for communications to a GC, it will not act as a Modbus slave device for communications from MeterLink™ or a SCADA system. USM can also poll a gas chromatograph using Modbus TCP/IP. Choose Port as Ethernet.
 - **GC protocol:** Select the protocol for which the GC is configured. The Rosemount Gas Ultrasonic meter uses 7 data bits, Even parity, and 1 stop bit for ASCII Modbus and 8 data bits, No parity, and 1 stop bit for RTU Modbus. This option will be enabled only when a serial port is selected.
 - **GC baud rate:** Select the baud rate for which the GC is configured. This option will be enabled only when a serial port is selected.
 - **GC comms address:** Enter the Modbus ID of the GC.
 - **GC IP address:** Enter the IP address of the GC. This option is only enabled when Port is selected as Ethernet.
 - **GC TCP/IP port number:** Enter Modbus TCP/IP port number of the GC. This option is only enabled when Port is selected as Ethernet.
 - **GC stream number:** Enter the stream number for the gas composition the Gas Ultrasonic meter will read.

- **GC heating value units:** Select the units for which the heating value is configured in the GC.
 - **Use which gas composition on GC alarm:** Select which gas composition the Gas Ultrasonic meter will use if the GC goes into alarm. If Fixed value is selected, the meter will start using the fixed gas composition stored in the meter. If Last good value is selected, the meter will use the last gas composition collected from the GC before the GC started to report alarms.
16. Click **Next** to continue to the Gas Chromatograph Data.
 17. Configure the Component indexes and the C6+ split. This page is available for Gas Ultrasonic meters and displayed only if View Gas Chromatograph **check box** was selected on the Startup page and if the Gas Chromatograph Setup page was previously displayed.
 18. Click **Next** to continue to the AGA8 page.
 19. Configure the properties necessary for the AGA8 calculations.
This page is only displayed for Gas Ultrasonic meters if both temperature and pressure are set to Live Analog, Fixed and Base condition correction is selected on the Startup Page. Configuration parameters include:
 - Calculations performed internally (by the meter) or Externally
 - AGA8 method - Gross Method 1, Gross method 2, Detail Method or GERG-2008
 - GC composition source - Fixed, Live GC
 - Base temperature and pressure
 - Specific gravity - reference temperature and pressure
 - Volumetric gross heating value and reference temperature
 - Molar density reference temperature and pressure
 - Flow Mass density, flow compressibility and Base compressibility
 - Gas composition inputs - components and mole percent
 20. If View Continuous Flow Analysis setup was selected on the Startup page, then click **Next** to continue to the Continuous Flow Analysis page.
 21. Configure the Continuous Flow Analysis (optional). This page is only displayed for Gas Ultrasonic meters if both temperature and pressure are set to Live Analog, Fixed and Base condition correction is selected on the Startup Page. Configuration parameters include:
 - a) Enable SOS comparison (requires AGA 8 Detail Method or GERG-2008).
 - b) Enable liquid detection and Profile factor limit.
 - c) Enable Blockage. Enter the percent for Symmetry, Cross-flow, Chords A to H turbulence.
 - d) Enable Internal bore buildup.
 - e) Click **Next** to continue to the Alarm Limits page.
 22. Configure Alarm Limits for flow analysis, reverse flow:
 - a) Set low and high flow limits for flow analysis alarms.
 - b) Enable/Disable Reverse Flow alarm.
 - c) Set Volume limit and low flow limit for reverse flow alarm.

- d) Click **Next** to continue to the **Local Display** setup, if View local display setup was selected on the Startup page.
23. Configure the parameters for the local display.
 24. Use the drop-down arrow in the Display Items list box and select or modify the parameters that will be displayed; the Display items, the Display units and the Scroll Delay.

4.2.1 Display items

The Local Display's labels and descriptions are shown below:

Table 4-1: Local display labels, descriptions and valid units

Local display labels, descriptions and valid units	
QFLOW — Uncorrected volume flow rate	
	<ul style="list-style-type: none"> • ACF – Actual Cubic Feet • ACM – Actual Cubic Meters • MACF – Thousand Actual Cubic Feet • MACM –Thousand Actual Cubic Meters
TDYVL — Current day's forward uncorrected volume	
	<ul style="list-style-type: none"> • +ACF – Actual Cubic Feet • +ACM – Actual Cubic Meters • +MACF – Thousand Actual Cubic Feet • +MACM –Thousand Actual Cubic Meters
TDYVL — Current day's reverse uncorrected volume	
	<ul style="list-style-type: none"> • -ACF – Actual Cubic Feet • -ACM – Actual Cubic Meters • -MACF – Thousand Actual Cubic Feet • -MACM –Thousand Actual Cubic Meters
YSTVL — Previous day's forward uncorrected volume	
	<ul style="list-style-type: none"> • +ACF – Actual Cubic Feet • +ACM – Actual Cubic Meters • +MACF – Thousand Actual Cubic Feet • +MACM –Thousand Actual Cubic Meters
YSTVL — Previous day's reverse uncorrected volume	
	<ul style="list-style-type: none"> • -ACF – Actual Cubic Feet • -ACM – Actual Cubic Meters • -MACF – Thousand Actual Cubic Feet
TOTVL — Forward uncorrected volume	

Table 4-1: Local display labels, descriptions and valid units (continued)

Local display labels, descriptions and valid units	
	<ul style="list-style-type: none"> • +ACF – Actual Cubic Feet • +ACM – Actual Cubic Meters • +MACF – Thousand Actual Cubic Feet • +MACM –Thousand Actual Cubic Meters
TOTVL — Reverse uncorrected volume	
	<ul style="list-style-type: none"> • -ACF – Actual Cubic Feet • -ACM – Actual Cubic Meters • -MACF – Thousand Actual Cubic Feet • -MACM –Thousand Actual Cubic Meters
QBASE — Corrected volume flow rate	
	<ul style="list-style-type: none"> • SCF – Standard Cubic Feet • SCM – Standard Cubic Meters • MSCF – Thousand Standard Cubic Feet • MSCM – Thousand Standard Cubic Meters
TDYVL — Current days forward corrected volume	
	<ul style="list-style-type: none"> • +SCF – Standard Cubic Feet • +SCM – Standard Cubic Meters • +MSCF – Thousand Standard Cubic Feet • +MSCM – Thousand Standard Cubic Meters
TDYVL — Current days reverse corrected volume	
	<ul style="list-style-type: none"> • -SCF – Standard Cubic Feet • -SCM – Standard Cubic Meters • -MSCF – Thousand Standard Cubic Feet • -MSCM – Thousand Standard Cubic Meters
YSTVL — Previous days forward corrected volume	
	<ul style="list-style-type: none"> • +SCF – Standard Cubic Feet • +SCM – Standard Cubic Meters • +MSCF – Thousand Standard Cubic Feet • +MSCM – Thousand Standard Cubic Meters
YSTVL — Previous days reverse corrected volume	
	<ul style="list-style-type: none"> • -SCF – Standard Cubic Feet • -SCM – Standard Cubic Meters • -MSCF – Thousand Standard Cubic Feet • -MSCM – Thousand Standard Cubic Meters
TOTVL — Forward corrected volume	

Table 4-1: Local display labels, descriptions and valid units (continued)

Local display labels, descriptions and valid units	
	<ul style="list-style-type: none"> +SCF – Standard Cubic Feet +SCM – Standard Cubic Meters +MSCF – Thousand Standard Cubic Feet +MSCM – Thousand Standard Cubic Meters
TOTVL — Reverse corrected volume	
	<ul style="list-style-type: none"> -SCF – Standard Cubic Feet -SCM – Standard Cubic Meters -MSCF – Thousand Standard Cubic Feet -MSCM – Thousand Standard Cubic Meters
VEL — Average flow velocity	
	<ul style="list-style-type: none"> Ft/S – Feet per Second M/S – Meters per Second
SOS — Average sound velocity	
	<ul style="list-style-type: none"> Ft/S – Feet per Second M/S – Meters per Second
TEMP — Flow-condition temperature	
	<ul style="list-style-type: none"> DEGF – Degrees Fahrenheit DEGC – Degrees Celsius
PRESS — Flow-condition pressure	
	<ul style="list-style-type: none"> PSI – Pound per square inch MPA – Megapascals
FRQ1A — Frequency channel 1A	
	<ul style="list-style-type: none"> HZ – Hertz
FRQ1B — Frequency channel 1B	
	<ul style="list-style-type: none"> HZ – Hertz
KFCT1 — Frequency 1 K-factor	
	<ul style="list-style-type: none"> CF – Cubic Feet CM – Cubic Meters MCF – Thousand Cubic Feet MCM – Thousand Cubic Meters
FRQ2A — Frequency channel 2A	
	<ul style="list-style-type: none"> HZ – Hertz
FRQ2B — Frequency channel 2B	
	<ul style="list-style-type: none"> HZ – Hertz

Table 4-1: Local display labels, descriptions and valid units (continued)

Local display labels, descriptions and valid units	
KFCT2 — Frequency 2 K-factor	
	<ul style="list-style-type: none"> • CF – Cubic Feet • CM – Cubic Meters • MCF – Thousand Cubic Feet • MCM – Thousand Cubic Meters
AO1 — Analog Output 1 current	
	<ul style="list-style-type: none"> • MA – Milliamperes
AO2 — Analog Output 2 current	
	<ul style="list-style-type: none"> • MA – Milliamperes

Note

When connected to a meter with the local display option, reverse flow direction is indicated with a minus sign (negative) before the value(s) shown on the local display.

4.2.2 Display units

The Meter volume units displayed are either U.S. Customary or Metric. To modify the Display Units, configure the Meter units system in the **Field Setup Wizard** → **General Page**.

- U.S. Customary volume unit selections are:
 - Cubic feet
 - Thousand cubic feet
- Metric volume unit selections are:
 - Cubic meters
- Display units preceded by a plus or minus sign indicate forward and reverse flow direction.
- The local display Flow rate time units are modifiable by selecting the dropdown arrow and clicking the time unit in the list box.
- Valid flow rate time units selections are:
 - second
 - hour
 - day

4.2.3 Scroll delay

The scroll delay is the time interval for the selected display items to be shown on the Local Display.

The default scroll delay setting is five seconds. Click the spin box **up** or **down** arrow to increase or decrease the length of time an item displays.

Procedure

1. Select **Finish** to write the configuration settings to the meter.

2. Save the meter configuration file, collect a Maintenance log and Waveforms to document the “As Left” settings.

4.3 Security seals for the meter

For the integrity of the meter metrology and to prevent tampering with the transmitter electronics and transducer assemblies, attach security latches on the endcaps. Also, if required, install security wires on the Transmitter Electronics Enclosure endcaps, the Bracket/Cover cap head screws.

See [Security seal installation](#) and [Sealing the unit](#).

4.4 Configure users and network security

Starting with Rosemount 3410 Series Firmware v1.60, the meter must authenticate any user making a connection to the meter using **MeterLink**. **MeterLink** will prompt for a username and password that will be authenticated by the meter before a successful connection is established. While the default password is unique to each meter, it is highly recommended to be changed at meter startup. For added security, the default username, administrator, can be changed as well.

See Manage Users in the Rosemount 3410 Series Gas Ultrasonic Flow Meters: Operations Manual ([00809-0800-3104](#)) for more details on setting up users, user types and passwords using the **Meter** → **Manage Users** dialog box in **MeterLink**.

If the 3410 Series Electronics will be connected to a network, please read the security recommendations found in Cybersecurity and network communications in the Rosemount 3410 Series Gas Ultrasonic Flow Meters: Operations Manual ([00809-0800-3104](#)).

A Engineering drawings

A.1 Rosemount 3410 Series engineering drawings

This appendix contains the following engineering drawing(s) for the ultrasonic meter.

DMC-005324	3410 Series Gas Ultrasonic Flow Meters System Wiring Diagram
------------	--

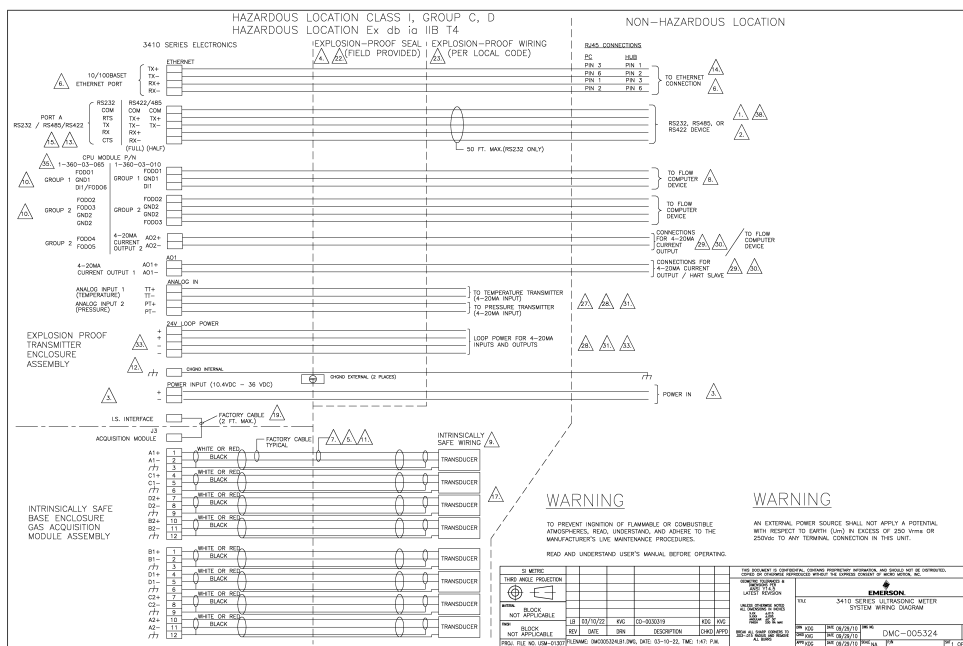

B Open source licenses

B.1 List of source codes for executable files

For a copy of the source code covered under the open source licenses indicated in this appendix, Contact flow.support@emerson.com.

B.1.1 GNU General Public License

For more details about GNU GPL (General Public License), follow the link below:

www.gnu.org

Micro Motion Inc., uses GPL version 2.

www.gnu.org/licenses/old-licenses/gpl-2.0.html

The GNU GPL is currently version 3.

www.gnu.org/licenses/quick-guide-gplv3.html

See GPL license on the following pages.

The GNU General Public License (GPL)

Version 2, June 1991

Copyright (C) 1989, 1991 Free Software Foundation, Inc.

59 Temple Place, Suite 330, Boston, MA 02111-1307 USA

Everyone is permitted to copy and distribute verbatim copies of this license document, but changing it is not allowed.

Preamble

The licenses for most software are designed to take away your freedom to share and change it. By contrast, the GNU General Public License is intended to guarantee your freedom to share and change free software--to make sure the software is free for all its users. This General Public License applies to most of the Free Software Foundation's software and to any other program whose authors commit to using it. (Some other Free Software Foundation software is covered by the GNU Library General Public License instead.) You can apply it to your programs, too.

When we speak of free software, we are referring to freedom, not price. Our General Public Licenses are designed to make sure that you have the freedom to distribute copies of free software (and charge for this service if you wish), that you receive source code or can get it if you want it, that you can change the software or use pieces of it in new free programs; and that you know you can do these things.

To protect your rights, we need to make restrictions that forbid anyone to deny you these rights or to ask you to surrender the rights. These restrictions translate to certain responsibilities for you if you distribute copies of the software, or if you modify it.

For example, if you distribute copies of such a program, whether gratis or for a fee, you must give the recipients all the rights that you have. You must make sure that they, too, receive or can get the source code. And you must show them these terms so they know their rights.

We protect your rights with two steps: (1) copyright the software, and (2) offer you this license which gives you legal permission to copy, distribute and/or modify the software.

Also, for each author's protection and ours, we want to make certain that everyone understands that there is no warranty for this free software. If the software is modified by someone else and passed on, we want its recipients to know that what they have is not the original, so that any problems introduced by others will not reflect on the original authors' reputations.

Finally, any free program is threatened constantly by software patents. We wish to avoid the danger that redistributors of a free program will individually obtain patent licenses, in effect making the program proprietary. To prevent this, we have made it clear that any patent must be licensed for everyone's free use or not licensed at all.

The precise terms and conditions for copying, distribution and modification follow.

TERMS AND CONDITIONS FOR COPYING, DISTRIBUTION AND MODIFICATION

0. This License applies to any program or other work which contains a notice placed by the copyright holder saying it may be distributed under the terms of this General Public License. The "Program", below, refers to any such program or work, and a "work based on the Program" means either the Program or any derivative work under copyright law: that is to say, a work containing the Program or a portion of it, either verbatim or with modifications and/or translated into another language. (Hereinafter, translation is included without limitation in the term "modification".) Each licensee is addressed as "you".

Activities other than copying, distribution and modification are not covered by this License; they are outside its scope. The act of running the Program is not restricted, and the output from the Program is covered only if its contents constitute a work based on the Program (independent of having been made by running the Program). Whether that is true depends on what the Program does.

1. You may copy and distribute verbatim copies of the Program's source code as you receive it, in any medium, provided that you conspicuously and appropriately publish on each copy an appropriate copyright notice and disclaimer of warranty; keep intact all the notices that refer to this License and to the absence of any warranty; and give any other recipients of the Program a copy of this License along with the Program.

You may charge a fee for the physical act of transferring a copy, and you may at your option offer warranty protection in exchange for a fee.

2. You may modify your copy or copies of the Program or any portion of it, thus forming a work based on the Program, and copy and distribute such modifications or work under the terms of Section 1 above, provided that you also meet all of these conditions:

a) You must cause the modified files to carry prominent notices stating that you changed the files and the date of any change.

b) You must cause any work that you distribute or publish, that in whole or in part contains or is derived from the Program or any part thereof, to be licensed as a whole at no charge to all third parties under the terms of this License.

c) If the modified program normally reads commands interactively when run, you must cause it, when started running for such interactive use in the most ordinary way, to print or display an announcement including an appropriate copyright notice and a notice that there is no warranty (or else, saying that you provide a warranty) and that users may redistribute the program under these conditions, and telling the user how to view a copy of this License. (Exception: if the Program itself is interactive but does not normally print such an announcement, your work based on the Program is not required to print an announcement.)

These requirements apply to the modified work as a whole. If identifiable sections of that work are not derived from the Program, and can be reasonably considered independent

and separate works in themselves, then this License, and its terms, do not apply to those sections when you distribute them as separate works. But when you distribute the same sections as part of a whole which is a work based on the Program, the distribution of the whole must be on the terms of this License, whose permissions for other licensees extend to the entire whole, and thus to each and every part regardless of who wrote it.

Thus, it is not the intent of this section to claim rights or contest your rights to work written entirely by you; rather, the intent is to exercise the right to control the distribution of derivative or collective works based on the Program.

In addition, mere aggregation of another work not based on the Program with the Program (or with a work based on the Program) on a volume of a storage or distribution medium does not bring the other work under the scope of this License.

3. You may copy and distribute the Program (or a work based on it, under Section 2) in object code or executable form under the terms of Sections 1 and 2 above provided that you also do one of the following:

a) Accompany it with the complete corresponding machine-readable source code, which must be distributed under the terms of Sections 1 and 2 above on a medium customarily used for software interchange; or,

b) Accompany it with a written offer, valid for at least three years, to give any third party, for a charge no more than your cost of physically performing source distribution, a complete machine-readable copy of the corresponding source code, to be distributed under the terms of Sections 1 and 2 above on a medium customarily used for software interchange; or,

c) Accompany it with the information you received as to the offer to distribute corresponding source code. (This alternative is allowed only for noncommercial distribution and only if you received the program in object code or executable form with such an offer, in accord with Subsection b above.)

The source code for a work means the preferred form of the work for making modifications to it. For an executable work, complete source code means all the source code for all modules it contains, plus any associated interface definition files, plus the scripts used to control compilation and installation of the executable. However, as a special exception, the source code distributed need not include anything that is normally distributed (in either source or binary form) with the major components (compiler, kernel, and so on) of the operating system on which the executable runs, unless that component itself accompanies the executable.

If distribution of executable or object code is made by offering access to copy from a designated place, then offering equivalent access to copy the source code from the same place counts as distribution of the source code, even though third parties are not compelled to copy the source along with the object code.

4. You may not copy, modify, sublicense, or distribute the Program except as expressly provided under this License. Any attempt otherwise to copy, modify, sublicense or distribute the Program is void, and will automatically terminate your rights under this License. However, parties who have received copies, or rights, from you under this License will not have their licenses terminated so long as such parties remain in full compliance.

5. You are not required to accept this License, since you have not signed it. However, nothing else grants you permission to modify or distribute the Program or its derivative works. These actions are prohibited by law if you do not accept this License. Therefore, by modifying or distributing the Program (or any work based on the Program), you indicate your acceptance of this License to do so, and all its terms and conditions for copying, distributing or modifying the Program or works based on it.

6. Each time you redistribute the Program (or any work based on the Program), the recipient automatically receives a license from the original licensor to copy, distribute or modify the Program subject to these terms and conditions. You may not impose any

further restrictions on the recipients' exercise of the rights granted herein. You are not responsible for enforcing compliance by third parties to this License.

7. If, as a consequence of a court judgment or allegation of patent infringement or for any other reason (not limited to patent issues), conditions are imposed on you (whether by court order, agreement or otherwise) that contradict the conditions of this License, they do not excuse you from the conditions of this License. If you cannot distribute so as to satisfy simultaneously your obligations under this License and any other pertinent obligations, then as a consequence you may not distribute the Program at all. For example, if a patent license would not permit royalty-free redistribution of the Program by all those who receive copies directly or indirectly through you, then the only way you could satisfy both it and this License would be to refrain entirely from distribution of the Program.

If any portion of this section is held invalid or unenforceable under any particular circumstance, the balance of the section is intended to apply and the section as a whole is intended to apply in other circumstances.

It is not the purpose of this section to induce you to infringe any patents or other property right claims or to contest validity of any such claims; this section has the sole purpose of protecting the integrity of the free software distribution system, which is implemented by public license practices. Many people have made generous contributions to the wide range of software distributed through that system in reliance on consistent application of that system; it is up to the author/donor to decide if he or she is willing to distribute software through any other system and a licensee cannot impose that choice.

This section is intended to make thoroughly clear what is believed to be a consequence of the rest of this License.

8. If the distribution and/or use of the Program is restricted in certain countries either by patents or by copyrighted interfaces, the original copyright holder who places the Program under this License may add an explicit geographical distribution limitation excluding those countries, so that distribution is permitted only in or among countries not thus excluded. In such case, this License incorporates the limitation as if written in the body of this License.

9. The Free Software Foundation may publish revised and/or new versions of the General Public License from time to time. Such new versions will be similar in spirit to the present version, but may differ in detail to address new problems or concerns.

Each version is given a distinguishing version number. If the Program specifies a version number of this License which applies to it and "any later version", you have the option of following the terms and conditions either of that version or of any later version published by the Free Software Foundation. If the Program does not specify a version number of this License, you may choose any version ever published by the Free Software Foundation.

10. If you wish to incorporate parts of the Program into other free programs whose distribution conditions are different, write to the author to ask for permission. For software which is copyrighted by the Free Software Foundation, write to the Free Software Foundation; we sometimes make exceptions for this. Our decision will be guided by the two goals of preserving the free status of all derivatives of our free software and of promoting the sharing and reuse of software generally.

NO WARRANTY

11. BECAUSE THE PROGRAM IS LICENSED FREE OF CHARGE, THERE IS NO WARRANTY FOR THE PROGRAM, TO THE EXTENT PERMITTED BY APPLICABLE LAW. EXCEPT WHEN OTHERWISE STATED IN WRITING THE COPYRIGHT HOLDERS AND/OR OTHER PARTIES PROVIDE THE PROGRAM "AS IS" WITHOUT WARRANTY OF ANY KIND, EITHER EXPRESSED OR IMPLIED, INCLUDING, BUT NOT LIMITED TO, THE IMPLIED WARRANTIES OF MERCHANTABILITY AND FITNESS FOR A PARTICULAR PURPOSE. THE ENTIRE RISK AS TO THE QUALITY AND PERFORMANCE OF THE PROGRAM IS WITH YOU. SHOULD THE

PROGRAM PROVE DEFECTIVE, YOU ASSUME THE COST OF ALL NECESSARY SERVICING, REPAIR OR CORRECTION.

12. IN NO EVENT UNLESS REQUIRED BY APPLICABLE LAW OR AGREED TO IN WRITING WILL ANY COPYRIGHT HOLDER, OR ANY OTHER PARTY WHO MAY MODIFY AND/OR REDISTRIBUTE THE PROGRAM AS PERMITTED ABOVE, BE LIABLE TO YOU FOR DAMAGES, INCLUDING ANY GENERAL, SPECIAL, INCIDENTAL OR CONSEQUENTIAL DAMAGES ARISING OUT OF THE USE OR INABILITY TO USE THE PROGRAM (INCLUDING BUT NOT LIMITED TO LOSS OF DATA OR DATA BEING RENDERED INACCURATE OR LOSSES SUSTAINED BY YOU OR THIRD PARTIES OR A FAILURE OF THE PROGRAM TO OPERATE WITH ANY OTHER PROGRAMS), EVEN IF SUCH HOLDER OR OTHER PARTY HAS BEEN ADVISED OF THE POSSIBILITY OF SUCH DAMAGES.

END OF TERMS AND CONDITIONS

How to Apply These Terms to Your New Programs

If you develop a new program, and you want it to be of the greatest possible use to the public, the best way to achieve this is to make it free software which everyone can redistribute and change under these terms.

To do so, attach the following notices to the program. It is safest to attach them to the start of each source file to most effectively convey the exclusion of warranty; and each file should have at least the "copyright" line and a pointer to where the full notice is found.

One line to give the program's name and a brief idea of what it does. Copyright (C) <<year>> <<name of author>>

This program is free software; you can redistribute it and/or modify it under the terms of the GNU General Public License as published by the Free Software Foundation; either version 2 of the License, or (at your option) any later version.

This program is distributed in the hope that it will be useful, but WITHOUT ANY WARRANTY; without even the implied warranty of MERCHANTABILITY or FITNESS FOR A PARTICULAR PURPOSE. See the GNU General Public License for more details.

You should have received a copy of the GNU General Public License along with this program; if not, write to the Free Software Foundation, Inc., 59 Temple Place, Suite 330, Boston, MA 02111-1307 USA

Also add information on how to contact you by electronic and paper mail.

If the program is interactive, make it output a short notice like this when it starts in an interactive mode:

Gnomovision version 69, Copyright (C) year name of author Gnomovision comes with ABSOLUTELY NO WARRANTY; for details type `show w'. This is free software, and you are welcome to redistribute it under certain conditions; type `show c' for details.

The hypothetical commands `show w' and `show c' should show the appropriate parts of the General Public License. Of course, the commands you use may be called something other than `show w' and `show c'; they could even be mouse-clicks or menu items-- whatever suits your program.

You should also get your employer (if you work as a programmer) or your school, if any, to sign a "copyright disclaimer" for the program, if necessary. Here is a sample; alter the names:

Yoyodyne, Inc., hereby disclaims all copyright interest in the program `Gnomovision' (which makes passes at compilers) written by James Hacker.

signature of Ty Coon, 1 April 1989

Ty Coon, President of Vice

This General Public License does not permit incorporating your program into proprietary programs. If your program is a subroutine library, you may consider it more useful to permit linking proprietary applications with the library. If this is what you want to do, use the GNU Library General Public License instead of this License.

B.1.2 GNU Lesser General Public License

GNU LESSER GENERAL PUBLIC LICENSE

Version 3, 29 June 2007

Copyright © 2007 Free Software Foundation, Inc. <<<http://fsf.org/>>>

Everyone is permitted to copy and distribute verbatim copies of this license document, but changing it is not allowed.

This version of the GNU Lesser General Public License incorporates the terms and conditions of version 3 of the GNU General Public License, supplemented by the additional permissions listed below.

0. Additional Definitions.

As used herein, "this License" refers to version 3 of the GNU Lesser General Public License, and the "GNU GPL" refers to version 3 of the GNU General Public License.

"The Library" refers to a covered work governed by this License, other than an Application or a Combined Work as defined below.

An "Application" is any work that makes use of an interface provided by the Library, but which is not otherwise based on the Library. Defining a subclass of a class defined by the Library is deemed a mode of using an interface provided by the Library.

A "Combined Work" is a work produced by combining or linking an Application with the Library. The particular version of the Library with which the Combined Work was made is also called the "Linked Version".

The "Minimal Corresponding Source" for a Combined Work means the Corresponding Source for the Combined Work, excluding any source code for portions of the Combined Work that, considered in isolation, are based on the Application, and not on the Linked Version.

The "Corresponding Application Code" for a Combined Work means the object code and/or source code for the Application, including any data and utility programs needed for reproducing the Combined Work from the Application, but excluding the System Libraries of the Combined Work.

1. Exception to Section 3 of the GNU GPL.

You may convey a covered work under sections 3 and 4 of this License without being bound by section 3 of the GNU GPL.

2. Conveying Modified Versions.

If you modify a copy of the Library, and, in your modifications, a facility refers to a function or data to be supplied by an Application that uses the facility (other than as an argument passed when the facility is invoked), then you may convey a copy of the modified version:

"a) under this License, provided that you make a good faith effort to ensure that, in the event an Application does not supply the function or data, the facility still operates, and performs whatever part of its purpose remains meaningful, or

"b) under the GNU GPL, with none of the additional permissions of this License applicable to that copy.

3. Object Code Incorporating Material from Library Header Files.

The object code form of an Application may incorporate material from a header file that is part of the Library. You may convey such object code under terms of your choice, provided that, if the incorporated material is not limited to numerical parameters, data structure layouts and accessors, or small macros, inline functions and templates (ten or fewer lines in length), you do both of the following:

- a) Give prominent notice with each copy of the object code that the Library is used in it and that the Library and its use are covered by this License.
- b) Accompany the object code with a copy of the GNU GPL and this license document.

4. Combined Works.

You may convey a Combined Work under terms of your choice that, taken together, effectively do not restrict modification of the portions of the Library contained in the Combined Work and reverse engineering for debugging such modifications, if you also do each of the following:

- a) Give prominent notice with each copy of the Combined Work that the Library is used in it and that the Library and its use are covered by this License.
- b) Accompany the Combined Work with a copy of the GNU GPL and this license document.
- c) For a Combined Work that displays copyright notices during execution, include the copyright notice for the Library among these notices, as well as a reference directing the user to the copies of the GNU GPL and this license document.
- d) Do one of the following:

0) Convey the Minimal Corresponding Source under the terms of this License, and the Corresponding Application Code in a form suitable for, and under terms that permit, the user to recombine or relink the Application with a modified version of the Linked Version to produce a modified Combined Work, in the manner specified by section 6 of the GNU GPL for conveying Corresponding Source.

1) Use a suitable shared library mechanism for linking with the Library. A suitable mechanism is one that (a) uses at run time a copy of the Library already present on the user's computer system, and (b) will operate properly with a modified version of the Library that is interface-compatible with the Linked Version.

e) Provide Installation Information, but only if you would otherwise be required to provide such information under section 6 of the GNU GPL, and only to the extent that such information is necessary to install and execute a modified version of the Combined Work produced by recombining or relinking the Application with a modified version of the Linked Version. (If you use option 4d0, the Installation Information must accompany the Minimal Corresponding Source and Corresponding Application Code. If you use option 4d1, you must provide the Installation Information in the manner specified by section 6 of the GNU GPL for conveying Corresponding Source.)

5. Combined Libraries

You may place library facilities that are a work based on the Library side by side in a single library together with other library facilities that are not Applications and are not covered by this License, and convey such a combined library under terms of your choice, if you do both of the following:

- a) Accompany the combined library with a copy of the same work based on the Library, uncombined with any other library facilities, conveyed under the terms of this License.
- b) Give prominent notice with the combined library that part of it is a work based on the Library, and explaining where to find the accompanying uncombined form of the same work.

6. Revised Versions of the GNU Lesser General Public License

The Free Software Foundation may publish revised and/or new versions of the GNU Lesser General Public License from time to time. Such new versions will be similar in spirit to the present version, but may differ in detail to address new problems or concerns.

Each version is given a distinguishing version number. If the Library as you received it specifies that a certain numbered version of the GNU Lesser General Public License "or any later version" applies to it, you have the option of following the terms and conditions either of that published version or of any later version published by the Free Software Foundation. If the Library as you received it does not specify a version number of the GNU Lesser General Public License, you may choose any version of the GNU Lesser General Public License ever published by the Free Software Foundation.

If the Library as you received it specifies that a proxy can decide whether future versions of the GNU Lesser General Public License shall apply, that proxy's public statement of acceptance of any version is permanent authorization for you to choose that version for the Library.

B.1.3 BSD Open Source License

For more details about the Open Source™ BSD license or the Open Source Initiative, follow the link below:

[Open Source BSD license](#)

Copyright (c) <YEAR>, <OWNER>

All rights reserved.

- Redistribution and use in source and binary forms, with or without modification, are permitted provided that the following conditions are met:
 - Redistributions of source code must retain the above copyright notice, this list of conditions and the following disclaimer.
 - Redistributions in binary form must reproduce the above copyright notice, this list of conditions and the following disclaimer in the documentation and/or other materials provided with the distribution.
 - Neither the name of Rosemount nor the names of its contributors may be used to endorse or promote products derived from this software without specific prior written permission.

THIS SOFTWARE IS PROVIDED BY THE COPYRIGHT HOLDERS AND CONTRIBUTORS "AS IS" AND ANY EXPRESS OR IMPLIED WARRANTIES, INCLUDING, BUT NOT LIMITED TO, THE IMPLIED WARRANTIES OF MERCHANTABILITY AND FITNESS FOR A PARTICULAR PURPOSE ARE DISCLAIMED. IN NO EVENT SHALL THE COPYRIGHT OWNER OR CONTRIBUTORS BE LIABLE FOR ANY DIRECT, INDIRECT, INCIDENTAL, SPECIAL, EXEMPLARY, OR CONSEQUENTIAL DAMAGES (INCLUDING, BUT NOT LIMITED TO, PROCUREMENT OF SUBSTITUTE GOODS OR SERVICES; LOSS OF USE, DATA, OR PROFITS; OR BUSINESS INTERRUPTION) HOWEVER CAUSED AND ON ANY THEORY OF LIABILITY, WHETHER IN CONTRACT, STRICT LIABILITY, OR TORT (INCLUDING NEGLIGENCE OR OTHERWISE) ARISING IN ANY WAY OUT OF THE USE OF THIS SOFTWARE, EVEN IF ADVISED OF THE POSSIBILITY OF SUCH DAMAGE.

B.1.4 M.I.T License

For more details about the Open Source™ MIT license or the Open Source Initiative:

[Open Source MIT license](#)

The MIT License

Copyright (c) <year> <copyright holders>

Permission is hereby granted, free of charge, to any person obtaining a copy of this software and associated documentation files (the "Software"), to deal in the Software without restriction, including without limitation the rights to use, copy, modify, merge, publish, distribute, sublicense, and/or sell copies of the Software, and to permit persons to whom the Software is furnished to do so, subject to the following conditions:

The above copyright notice and this permission notice shall be included in all copies or substantial portions of the Software.

THE SOFTWARE IS PROVIDED "AS IS", WITHOUT WARRANTY OF ANY KIND, EXPRESS OR IMPLIED, INCLUDING BUT NOT LIMITED TO THE WARRANTIES OF MERCHANTABILITY, FITNESS FOR A PARTICULAR PURPOSE AND NONINFRINGEMENT. IN NO EVENT SHALL THE AUTHORS OR COPYRIGHT HOLDERS BE LIABLE FOR ANY CLAIM, DAMAGES OR OTHER LIABILITY, WHETHER IN AN ACTION OF CONTRACT, TORT OR OTHERWISE, ARISING FROM, OUT OF OR IN CONNECTION WITH THE SOFTWARE OR THE USE OR OTHER DEALINGS IN THE SOFTWARE.

B.1.5 Zlib License

Copyright (C) 1995-2005 Jean-loup Gailly and Mark Adler

This software is provided 'as-is', without any express or implied warranty. In no event will the authors be held liable for any damages arising from the use of this software.

Permission is granted to anyone to use this software for any purpose, including commercial applications, and to alter it and redistribute it freely, subject to the following restrictions:

1. The origin of this software must not be misrepresented; you must not claim that you wrote the original software. If you use this software in a product, an acknowledgment in the product documentation would be appreciated but is not required.
2. Altered source versions must be plainly marked as such, and must not be misrepresented as being the original software.
3. This notice may not be removed or altered from any source distribution.

For more information: [Emerson.com/global](https://emerson.com/global)

©2023 Emerson. All rights reserved.

Emerson Terms and Conditions of Sale are available upon request. The Emerson logo is a trademark and service mark of Emerson Electric Co. Rosemount is a mark of one of the Emerson family of companies. All other marks are the property of their respective owners.

ROSEMOUNT™

