

**Industrial grade products to
meet the most demanding
applications worldwide.**



SolaHD™ Industrial Power Solutions

Power quality solutions to control your equipment or facility's efficiency, productivity, and longevity.



Introduction



SolaHD brand products by Emerson have been exclusively focused on providing total power quality throughout manufacturing facilities since 1915. During this time, production equipment and efficiencies have evolved beyond what was once thought possible; however, our commitment has remained the same. From service entrance to point-of-use, our SolaHD products are there to optimize production performance. We have stayed at the forefront of production technologies with power solutions designed exclusively for modern manufacturing's sensitive computerized equipment, such as networks, sensors, PLCs and safety equipment. Our broad line of DIN rail power products save space and provide flexibility for modifications in the field or reconfigurations and faster installations.



SolaHD products by Emerson can power your facility from the service entrance to the most critical production equipment in the harshest applications.

Industrial Facility Wide Protection ▶ p 5

Industrial Power Quality Solutions ▶ p 6

Power Quality Solutions for All Applications ▶ p 7

More Efficient Control Panels ▶ p 8

The Broadest Range of DIN Rail Products ▶ p 9

Filters and Surge Protective Devices ▶ p 10

Power Conditioners ▶ p 15

Uninterruptible Power Supplies ▶ p 18

Transformers ▶ p 24

Power Supplies ▶ p 30



Visit www.solahd.com or contact your local SolaHD representative to learn more about our Control Power solutions.

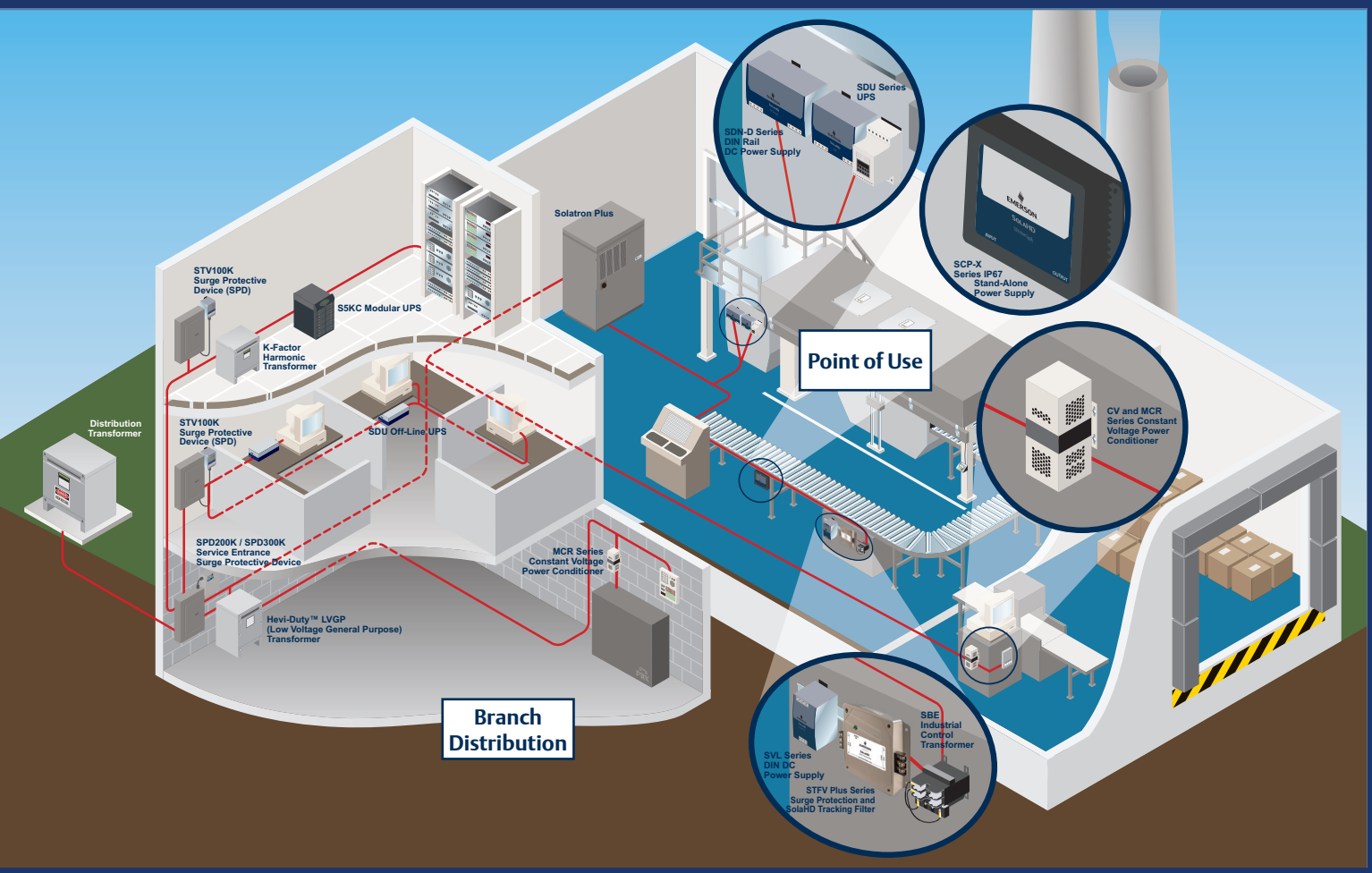

Establish and Maintain Total Power Quality Throughout Your Facility.

The number of system components has increased throughout today's manufacturing floors, along with their sensitivity to voltage fluctuations, harmonic distortions, noise and power outages. The increased number of devices drawing power from the utility grid has led to greater dependency on the level of power quality required in today's highly competitive, efficiency-driven world. Our SolaHD products stabilize, control and manage the power your equipment needs from the service entrance through branch distribution to points of use throughout your facility.

	Industrial Power Conversion and Protection Solutions				
	Power Conditioning	SPD/Filters	Transformers	Power Supplies	UPS
Service Entrance		X	X		
Branch Panels		X	X		X
Networks	X	X		X	X
Large Machinery	X	X	X	X	X
Process Rooms	X	X		X	X
PLC's and Industrial PC's	X	X	X	X	X
Ethernet and Communications		X		X	X
DeviceNet™		X		X	X
Motion Control		X		X	X
Drives	X	X	X		X
Analog I/O		X		X	X

Industrial Facility Wide Protection.

SolaHD power quality products by Emerson can ensure that industrial facilities and equipment will maintain the highest levels of productivity in three distinct ways: improving machine availability, providing reliable products and increasing the flexibility through a wide range of solutions for delivering clean power throughout your facility — in the control panel or distributed outside of the panel directly on the machine or equipment — wherever you need it.

Anywhere in your facility, from the service entrance to the most critical production equipment, Emerson can power your process control applications with our SolaHD power conversion and power quality products.

Improve Machine Availability

Emerson offers industrial grade products to meet the most demanding applications worldwide.

- Factory automation
- Inspection, test and instrumentation equipment
- Laboratory
- High efficiency applications
(Department of Environment [DOE] 2016 Compliant)
- UL508 environments such as waste water treatment
- Harsh environment and remote site locations
- Building automation
- Service automation
- Process control



Emerson offers many solutions for harsh environments including our SolaHD encapsulated power supplies and transformers. We also offer a wide range of products certified for hazardous locations, including IECEx.

When Power Is Money

Power is a dynamic aspect in production and automation. Companies lose billions of dollars every year due to voltage sags and power outages.

Conditioning your incoming power keeps productivity high and costs down. Using compatible power conversion components ensures system reliability.

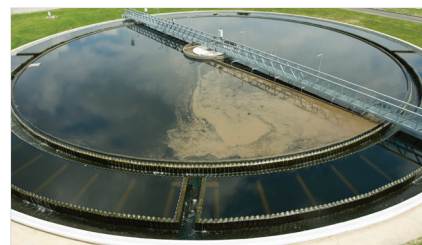

Power Is Our Business

Our industrial power specialists are serious about your system performance. SolaHD has been a trusted brand of power conversion and power quality products since 1915. Emerson provides innovative and reliable products with proven technologies to help control your equipment or facility's efficiency, productivity, and longevity. Our SolaHD products meet strict global requirements and new efficiency standards. We deliver total power quality solutions to drive your system reliability, your return on investment (ROI) and your customer satisfaction.



Power Products (14 Watts to 500 kVA)

Industrial Power Quality Solutions.

Only Emerson delivers industrial power solutions with a comprehensive, four-staged approach that includes protection and conditioning, back-up power supply and conversion, voltage regulation and knowledgeable service and support.

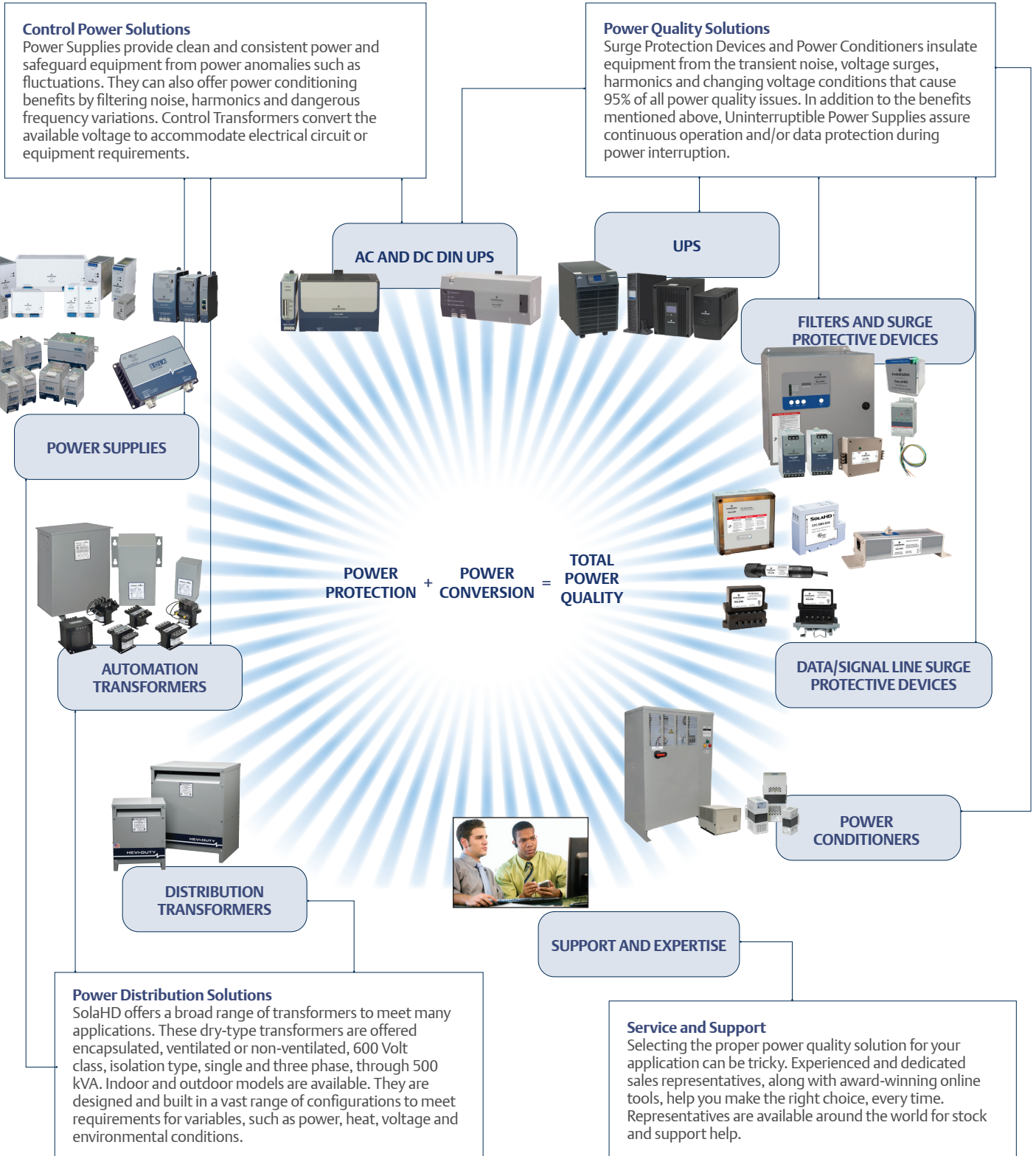

Power Quality Solutions for All Applications.

Power is our business. While every manufacturing environment requires different levels of protection, Emerson offers a broad range of SolaHD products that allows you to select the best solution for your power quality problem.

NOISE AND SURGE PROTECTION

Noise and surge protection devices convert, clean and maintain electric current from the factory entrance to equipment throughout your facility. They extend the life of a PLC and prevent catastrophic damage.



SPD200K and SPD300K
Surge Protective Devices



STFV Series
SolaHD Tracking Filters with Surge Protection



STC Series
Data/Line SPDs

DRIVE PROTECTION

Transformers are useful where the available voltage must be changed to accommodate the voltage required by the load. For many electrical circuits, a separately derived neutral secondary connection is required. They reduce noise and provide electrostatic shielding.



Drive Isolation Transformers for SCR (DC Drives)



K-Factor Transformers for VFD (AC Drives)

VOLTAGE REGULATION

Power anomalies such as fluctuations through complete power failures can cause damage to equipment. You can safeguard your system by implementing power supplies, power conditioners and UPSs to filter noise, harmonics and dangerous frequency variations.



SDN Power Supply
Sag Immunity and $\pm 2\%$ DC Regulation



MCR/CVS - 3% and 1%
Output Voltage Regulation



S4KC UPS
(On-Line)

BACK-UP

Uninterruptible Power Supplies provide back-up in the event of power interruption. We offer four topologies and classes of power protection.



SDU AC - B Series



SDU DC UPS



SSW UPS (Line-Interactive)



S5KC UPS (On-Line)

More Efficient Control Panels.

From surge protective devices to back-up DC power supplies to control transformers, Emerson is the only manufacturer to offer a total power quality solution within the control panel. This full line of integrated SolaHD products delivers reliable performance through compact and clearly labeled packages that allow for faster and easier panel installations.

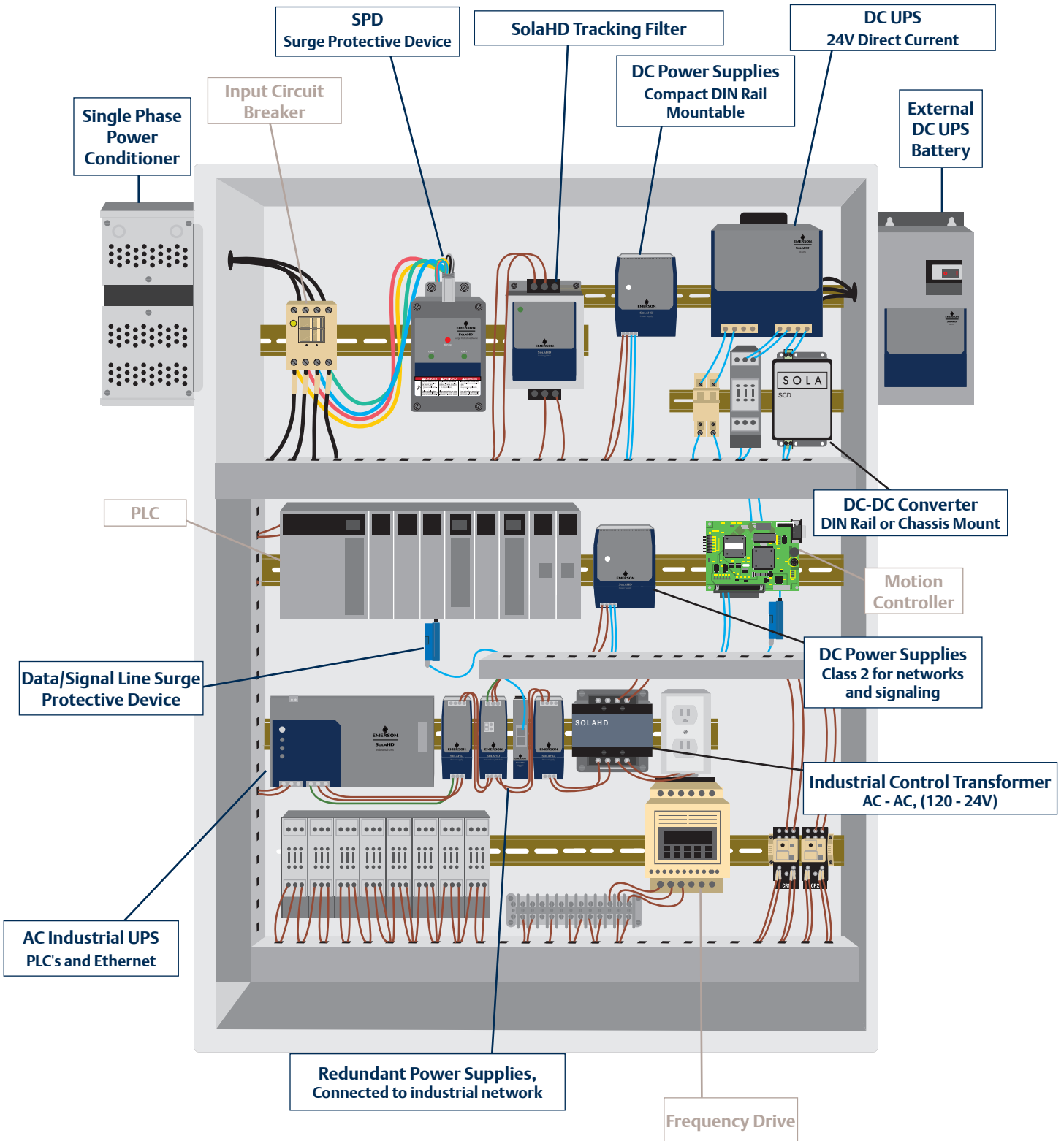

The Broadest Range of DIN Rail Products.

Emerson understands the need for flexible and modular production lines in today's manufacturing facilities. That's why we offer a wide range of SolaHD DIN rail mountable power quality solutions. Each product is compact, mounts fast and offers a clean look that is easy to monitor with visual diagnostic LEDs.

AC/DC DIN RAIL POWER SUPPLIES

Our highly-efficient, compact power supplies come in a wide range of voltages and available features, including PowerBoost overload circuitry, hazardous location certifications and optional redundant accessories.



SDN-D Series



SDN-C Series



SDPTM Series



SDN-P Series



SVL Series

DC/DC DIN RAIL POWER CONVERTERS

Provide power to industrial control instrumentation devices and equipment anywhere that AC power isn't convenient with our durable, compact DC to DC converters.



SCD Series

FILTERS AND SURGE PROTECTIVE DEVICES

SolaHD DIN rail mountable surge protective devices and filters deliver 24-hour protection from the full spectrum of voltage transients and noises that can cause long-term damage to sensitive equipment.



STV Series



STFV Plus Series



STFE Elite Series

AC AND DC UPS

Our advanced line of uninterruptible power supplies keep your machinery running with industry-leading, micro-processor controlled designs.



SDU DIN Rail DC UPS



SDU DIN Rail AC UPS

Filters and Surge Protective Devices



The continuous threats of spikes, noise and harmonic distortions severely impact the reliability of today's electronic equipment. Production, computing, networking and telecommunication equipment depend upon transient-free power for optimized performance. To successfully and dependably eliminate these disturbances, facilities must install multi-staged protection that can handle high-energy surges, electric noise and residual low-voltage transients.

Emerson safeguards production technologies with a comprehensive line of SolaHD surge protection and filtering devices that allow facilities to deploy the multi-staged protection that they require. As a necessary first line of defense, our SolaHD Surge Protective Devices are designed to clamp high-voltage spikes off to a level acceptable by even the most sensitive electronic equipment. Our exclusive, hybrid SolaHD Tracking Filters rid power from noise and transients, even in the harshest industrial environments. Our wide range of SolaHD Data/Signal Line products shutdown damaging low-energy surges with high-speed, high-energy components, a variety of voltage levels and unique packaging configurations for applications throughout your facility.

Filters and Surge Protective Devices

SPD200K AND SPD300K SERIES SURGE PROTECTIVE DEVICES



FEATURES

- Surge current capacity of 200 to 300 kA per phase
- Metal, UL Listed /NEMA type 1/12/3R/4 enclosure standard
- Rotary disconnect and transient counter
- All modes transient protection (L-N, L-G, and N-G)
- Form C dry contacts and audible alarm status indications
- Internal/external monitoring, including neutral to ground
- EMI/RFI Filtering
- Ten year limited warranty

The SPD Series offers surge protection to equipment throughout facilities with a flexible, modular design that is rugged enough for the harshest industrial environments. The SPD200K and SPD300K is capable of point-of-use applications, but also features technology that makes it robust enough to handle the high-impulse, potentially damaging transients commonly found at service entrances or distribution panels.

APPLICATIONS

- Industrial plants
- Commercial buildings
- Institutional facilities
- Electronics based equipment

RELATED PRODUCTS

- Power Conditioners
- Uninterruptible Power Supplies
- Transformers
- Surge Protective Devices

STV100K SERIES SURGE PROTECTIVE DEVICES



FEATURES

- 100,000 Amp peak current rating provides all mode protection against severe transients
- Low clamping levels for more effective protection
- 100 kAIC fault current fusing level provides safety and NEC conformance
- LED status, audible alarms and form C dry contacts
- Compact, rugged metal
- ABS Type Approval
- Ten year limited warranty

The STV100K Series hardwired surge protective devices are designed for installation at the service entrance, branch panel or a dedicated sensitive electronic load. These units feature all mode protection, LED and audible alarm status indication, sinewave tracking and form C dry contacts. The STV100K Series also contains the highest levels of safety built into the product including thermal fusing and a fault current fusing level of 100 kAIC.

APPLICATIONS

- Distribution panels (up to 800 Amp)
- Branch, lighting and control panels
- Factory automation installations
- Dedicated industrial equipment

RELATED PRODUCTS

- Power Conditioners
- Uninterruptible Power Supplies
- Drive Isolation and K-Factor Transformers

Filters and Surge Protective Devices

STFV PLUS SERIES SOLAHD TRACKING FILTERING WITH SURGE PROTECTION



The STFV Plus Series combines SolaHD Tracking filtration for low-energy noise and surge protection for high-energy transients. It continuously tracks the input AC power line. Upon detection of extraneous high-frequency noise and high-voltage transients caused by everyday events such as turning on machinery, motors, or equipment it responds instantly to filter the power disturbances.

FEATURES

- Series Filter/SPD technology for total durability
- High impact plastic case, epoxy encapsulated enclosure
- Transient protection in all modes (L-N, L-G, and N-G)
- Single phase applications up to 30 Amps
- Operating temperature from -40 °C to +60 °C (-40 °F to +140 °F)
- Hardwired connection
- LED power indication
- Ten year limited warranty

APPLICATIONS

- Branch and control panels
- Factory automation installations
- Point-of-use industrial service equipment
- Programmable logic controllers
- Dedicated industrial equipment
- Telecommunications and IT equipment

RELATED PRODUCTS

- Power Conditioners
- Uninterruptible Power Supplies
- Power Supplies

SPD50K SERIES SURGE PROTECTIVE DEVICES



The SPD50K Series offers easily monitored protection from surges. The visual diagnostic system that is featured in the SPD50K is easy to see and easy to diagnose. When the Green LED is visible, the protective device is okay and working correctly. When the Green LED is extinguished an audible alarm will sound and the equipment should be replaced. The LED is visible from multiple sides and angles to allow for better viewing of the status from any of the tri-mount options.

FEATURES

- 50 kA per phase surge current rating
- Type 1: UL 1449, CSA 22.2 No. 269.1
- 200 kA SCCR
- Complies with UL 96A 12th Edition master label requirements for lightning protection systems
- Voltage specific design
- Tri-mount installation possible via standard 0.75 in. nipple, DIN rail mount (rail not included) or bracket mount for flat surfaces
- Visual diagnostics
- Audible alarm with relay contacts
- Dry contact connection leads exit through nipple via #18 AWG (3 feet) at 24 Vdc @ 2 Amps
- Ten year limited warranty

APPLICATIONS

- Can be installed anywhere in any electrical distribution system; line-side or load-side of main disconnect

RELATED PRODUCTS

- Power Conditioners
- Uninterruptible Power Supplies
- Power Supplies

Filters and Surge Protective Devices

STV25K DIN RAIL SERIES - SURGE PROTECTIVE DEVICES



The STV25K Series provides point-of-use protection, at the dedicated equipment level, against damaging transients. Ideal for installation in electronic control cabinets found in harsh industrial environments such as the factory floor or at remote locations. This DIN rail series also provides protection on all electrical paths.

APPLICATIONS

- Control cabinets for industrial automation
- Point-of-use industrial/service equipment
- Remote commercial or industrial equipment
- Instrumentation and large test equipment
- Commercial and building automation systems

FEATURES

- Compact and narrow design maximizes panel space
- Low clamping levels for more effective protection
- Easy access terminal screws for quick mounting and installation
- 25,000 Amps of surge protection
- Sine wave tracking and all mode protection provide consistent and reliable protection on all electrical paths
- Thermal fusing prevents MOV overheating caused by excessive current levels
- ABS Type Approval
- Ten year limited warranty

RELATED PRODUCTS

- DIN rail Power Supplies
- DIN rail AC UPS
- Industrial Control Transformers
- SolaHD Tracking Filters

STFE ELITE SERIES DIN RAIL SOLAHD TRACKING FILTERING WITH SURGE PROTECTION



The STFE features a multi-stage design, combining a unique hybrid clamping network with the SolaHD Tracking Filter technology to provide protection against the full spectrum of voltage transients and surges. It continuously tracks the input AC power line responding instantly upon detecting extraneous high-frequency noise and high voltage transients caused by everyday events such as turning on machinery, motors or equipment.

APPLICATIONS

- Control panels
- Factory automation installations
- Point-of-use industrial equipment
- Programmable logic controllers
- Dedicated industrial equipment
- Machine tools equipment

FEATURES

- Series connected DIN rail mounted filter
- Durable metal mount clip
- Transient protection in all modes (L-N, L-G, and N-G)
- Single phase applications up to 20 Amps
- Wide operating temperature range available
- Screw terminal connections
- LED status indication
- Form C contact for remote monitoring
- ABS Type Approval
- CE Compliance (STFE10024L & STFE20024L only)
- Five year limited warranty

RELATED PRODUCTS

- Power Conditioners
- Uninterruptible Power Supplies
- Power Supplies

Filters and Surge Protective Devices

LOW VOLTAGE - DATA/SIGNAL LINE SURGE PROTECTIVE DEVICES



The rapid development of automated controls, telecommunications and fire/security systems has made it imperative to have properly coordinated low-voltage protection. Modern networked industrial facilities require error free transmission of information for maximum productivity and integrity of data.

The STC Series protects all susceptible low-voltage cable routes entering a facility and at key points within the building. These devices can be used as part of a multi-stage protection strategy which involves clamping the initial high-energy impulse, filtering any remaining noise or transients to the PLC or sensitive equipment and finally, protecting the data/signal lines entering and leaving the control panel.

The hybrid design of these Data/Signal Line surge suppressors allows them to respond quickly with high-energy absorption. These units are available in a variety of application specific voltage levels and packaging configurations. The STC Series is used to protect network signal lines entering or leaving control panels including PLCs, universal remote I/O, DeviceNet™ and Data Highway Plus.

FEATURES

- Low-voltage surge protection
- Hybrid technology
- Fast response time
- Low profile packaging
- Easy installation

APPLICATIONS

- STC-POE: Power-over-Ethernet, Category 5 and 6 for communications and control
- STC-DRS: DIN rail mountable, single-pair surge protection for DIN rail control
- STC-642: Two-pair data/signal protection, for panel and DIN rail control
- STC-SLAC: Three-stage series hybrid, signal line and AC protection, for water wastewater control
- STC-SS: Multi-stage hybrid suppressors for water wastewater motor control

RELATED PRODUCTS

- Power Conditioners
- Uninterruptible Power Supplies
- Surge Protective Devices
- SolaHD Tracking Filters
- Power Supplies

Power Conditioners



Power quality disturbances, including the smallest change in voltage level, can lead to unscheduled downtime, failed operations, incorrect data and scrapped production. Computerized and electronic automation equipment requires clean power that is free from damaging impulses, brownouts, harmonics, swells and sags. The most effective means for optimizing and protecting production efficiencies is with dedicated power conditioning solutions.

Emerson is the market leader in power conditioning equipment for industrial facilities. Our SolaHD product line is built on our dedication to provide the most efficient, reliable and effective protection for your sensitive production equipment. SolaHD power conditioning solutions deliver tightly regulated voltage with superior noise attenuation. Additionally, our units are maintenance-free and built for harsh industrial environments.

Power Conditioners

MCR HARDWIRED AND PORTABLE SERIES – POWER LINE CONDITIONERS WITH VOLTAGE REGULATION



 
E47379 LR044950



 
E47379 LR044950

FEATURES

- $\pm 3\%$ output voltage regulation
- Surge protection tested to ANSI/IEEE C62.41 Class A and B Waveform (< 10 V let-through typical)
- Noise attenuation
 - 120 dB common mode
 - 60 dB transverse mode
- Harmonic filtering
- Galvanic isolation provides exceptional circuit protection
- Point-of-use protection (cord and plug connected)
- Easy and flexible installation
- 25 year typical MTBF
- No maintenance required
- Ten + two year limited warranty

The MCR Series provides excellent noise filtering and surge protection to protect connected equipment from damage, degradation or misoperation. Combined with the excellent voltage regulation inherent to our ferroresonant design, they can increase the actual Mean Time Between Failure (MTBF) of protected equipment.

APPLICATIONS

- Computers/printers
- Telephone/Fax systems
- POS terminals
- Security systems
- Laboratory equipment
- LAN networks

RELATED PRODUCTS

- DIN Rail AC UPS (SDU)
- Off-Line UPS (S1K Mini-Tower)
- Line-Interactive UPS (S3K Mini-Tower)

CVS HARDWIRED SERIES - CONSTANT VOLTAGE TRANSFORMERS



 
E47379

FEATURES

- Superior voltage regulation of $\pm 1\%$
- Harmonic filtering
- Surge protection tested to ANSI/IEEE C62.41, Class A and B Waveform
- Hardwired
- Acts as a step-up/step-down transformer
- Galvanic isolation provides exceptional circuit protection
- 25 year typical MTBF
- No maintenance required
- Ten year limited warranty

Superior voltage regulation of $\pm 1\%$ sets the CVS Series apart from other power conditioning technologies on the market. Extremely tight regulation is accomplished by our ferroresonant transformer technology. The CVS recreates a well regulated sinusoidal waveform that is isolated from input disturbances.

APPLICATIONS

- Industrial automation and control equipment PLCs
- Analytical laboratory and factory automating equipment
- Photo processing equipment
- Sound/recording systems
- Photographic enlargers
- Broadcast equipment

RELATED PRODUCTS

- Power Conditioners
- Uninterruptible Power Supplies
- Power Supplies

Power Conditioners

SOLATRON™ PLUS SERIES – THREE PHASE POWER CONDITIONERS



The rugged construction of the SOLATRON™ Plus Series ensures high performance through inductive loads and poor power factor. It handles many power quality problems including isolation, voltage regulation and surge protection.

FEATURES

- Rugged, industrial construction
- High overload capability
- High MTBF - No fans used
- No power factor restriction on loads
- Tight regulation (regulate output voltage to $\pm 3\%$) for protection against under voltage (-25%) and over voltage (+10%) conditions
- No load current interruption for auto-bypass mode
- Status indicating lights
- Shielded, copper wound isolation transformer
- Surge protection to ANSI/IEEE and IEC standards
- High efficiency (96%) microprocessor controlled on-load tap changer
- Automatic over and under voltage regulation, auto restart upon power loss and return
- Two year limited warranty

APPLICATIONS

- Automatic packaging machinery
- Large machine tool equipment
- UPS bypass circuits
- Retail store
- Process equipment

RELATED PRODUCTS

- STV100K Surge Protective Device
- Isolation Transformers

Uninterruptible Power Supplies



Total protection of your production line is not complete without guarding against momentary and long term power interruptions. Power interruptions can occur unpredictably and with little or no warning. What they can leave behind is ruined production batches, damaged equipment and lost data. An Uninterruptible Power Supply (UPS) prevents power interruptions from affecting production momentum and equipment by seamlessly switching to back-up battery power the instant it detects a voltage irregularity.

Emerson is at the forefront of UPS technologies for industrial applications. We have a full range of Off-Line, Line-Interactive and On-Line SolaHD UPS systems. We were also the first to offer DIN rail mountable UPS systems. Their compact design and wide operating temperature range has made them the choice for facilities around the world. We pioneered the DC UPS as well. The DC UPS is the most efficient way to protect equipment running on 24 V DC power. Our SolaHD DC UPS offers the advantages of reducing the number of AC to DC conversions from three to one. This enables the DC UPS to eliminate unnecessary energy losses and heat build-up for greater efficiencies and a longer life.

Uninterruptible Power Supplies

USE AN AC UPS OR DC UPS?

AC UPS products have traditionally taken on battery back-up requirements for industrial applications. Why did we develop the SolaHD DC UPS? What are the advantages?

Initially, AC UPS systems were designed for environmentally controlled data centers and offices. These systems typically require a cooling fan because of their tendency to generate fair amounts of heat. In hot, dusty, industrial environments, the ability for the fan to cool the unit becomes challenged, translating into lower Mean Time Between Failure (MTBF). The AC UPS generates extra heat, and consumes more energy, because the 120 Volt AC power from the wall is converted three times to charge the batteries and power the control system. AC UPS's are also typically designed for 19" rack mounts. This makes them large and cumbersome for shallow NEMA control panels. The result is that many AC UPS systems are not compliant with UL508, which is required for control panel mounting. Emerson offers both an AC and DC SolaHD UPS that are DIN rail mounted and UL508 compliant.

THE SDU DC UPS WAS DESIGNED FOR MANUFACTURING

Our DC UPS reduces the number of times power is converted from three times to just one time. This enables a more compact packaging that allows the DC UPS to be DIN rail mounted within control panels.

Our SolaHD DC UPS features DIN rail mounting capabilities, high MTBF, UL 508, CE and FCC compliance. Battery performance is degraded by over and undercharging. For enhanced reliability, we fitted our SDU Series with a microprocessor brain that enables the unit's power charger to maintain the 24 Volt charge needed for maximum battery life. Heat is another enemy of battery performance. Our DC UPS enclosure was designed to protect the battery in operating temperatures as high as +50 °C (+122 °F).

The SDU DC UPS also offers a host of essential operational and diagnostic features that are required by today's modern production facilities:

- LED indicators of control power source and battery conditions
- Remote monitoring, diagnostics and shutoff capabilities
- Overload protection in both normal and battery modes
- Automatic self-testing of the control power source functionality and battery condition
- Universal system monitoring relay terminals

Uninterruptible Power Supplies

SDU SERIES, DIN RAIL AC UPS



The SDU DIN Rail AC UPS combines an industry-leading compact design with a wide operating temperature range and unique installation options for economical protection from damaging impulses and power interruptions. These units include easy-to-wire screw terminations for critical devices, such as computer-based control systems, that require a battery back-up. Available communication card port and USB connection for monitoring.

FEATURES

- Lightweight, compact industrial design
- Wide operating temperature range, 0 °C to +50 °C (+32 °F to +122 °F)
- Cold start capability
- Software and cable included for easy installation
- Simulated sinewave output
- USB communication port
- Suitable for UL 508 and CSA C22.2 No. 107.1 Industrial Control Equipment Applications with no VA derating
- Form C dry contact relay (optional)
- Panel/Wall mounting brackets (optional)
- Remote turn-on and shut-off capabilities
- Compact flash communication cards for Fieldbus protocols (optional)
- Two year limited warranty

APPLICATIONS

- Programmable logic controllers
- Factory automation
- Robotics
- Conveying equipment
- Computer-based control systems

RELATED PRODUCTS

- Power Conditioners
- STV Surge Protective Devices
- SDN DIN Rail Power Supplies
- STFV Plus SolaHD Tracking Filters

SDU SERIES, DIRECT CURRENT UNINTERRUPTIBLE POWER SUPPLY (DC UPS)

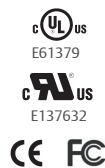
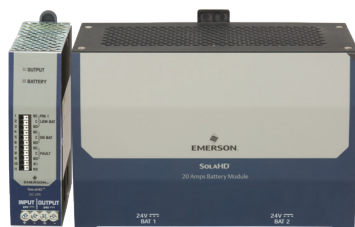

The SDU DIN Rail DC UPS is an advanced 24 Vdc uninterruptible power supply that offers rugged and compact housing, wide operational temperature range and unique installation options. With an input voltage range of 22.5 to 30.0 Vdc, the DC UPS is the ideal back-up power solution for your critical connected loads.

The SDU DC UPS provides higher conversion efficiencies by reducing the number of times power is converted from AC to DC and back. These efficiencies enable maximum system up-time flexibility and optimized reliability assurance.

FEATURES

- Modular, rugged industrial design
- Microprocessor based controls
- Automatic self-test feature for UPS function and battery management check
- Wide power module operation temperature range from -20 °C to +50 °C (-4 °F to +122 °F)
- Flexible batteries back-up expansion capabilities
- Overload protection in normal and battery modes
- User replaceable batteries
- IP20 rated input and output screw terminals
- No internal fan, no extra cooling required

APPLICATIONS

- Industrial/machine control
- Computer-based control systems
- Conveying equipment
- Material handling and packaging machines
- Semiconductor fabrication equipment
- DeviceNet™
- Amusement park equipment
- Pharmaceutical applications
- Control rooms

RELATED PRODUCTS

- SDN-P Series DIN Rail Power Supplies
- SDN-C Series DIN Rail Power Supplies
- STV25K Series Surge Protective Devices

Uninterruptible Power Supplies

SLN AND SPS MINI-TOWER OFF-LINE UPS



The SLN and SPS Series provides economical protection from damaging impulses and power interruptions. These units include three outlets for critical devices needing battery back-up and surge protection. The SLN and SPS is ideal for industrial environments as well as point of sale and office applications.

APPLICATIONS

- PCs
- Workstations
- Computer terminals

RELATED PRODUCTS

- Surge Protective Devices
- SolaHD Tracking Filters
- Portable MCR Power Conditioners

FEATURES

- Lightweight, compact design
- NEMA 5-15R outlets, protected by battery and surges
- USB communications interface
- Cable included with free software download
- Two year limited warranty

SSW MINI-TOWER LINE-INTERACTIVE UPS



The SSW Series is an economical choice for those applications requiring the performance of a sinewave output, line interactive UPS with the mini-tower shape for cabinet installations. The SSW Series protects against most severe power disturbances through state-of-the-art, line-interactive technology. Most power disturbance corrections are accomplished without transferring to the internal battery. Utility power is continually protected by the SSW Series UPS and internal battery life is optimized.

APPLICATIONS

- Industrial automation systems
- PLCs
- Robotics and process control
- Workstations
- Automatic service and dispensing equipment

RELATED PRODUCTS

- Portable MCR Power Conditioners
- Surge Protective Devices
- SolaHD Tracking Filters

FEATURES

- Mini Tower design for control cabinet installation
- Automatic voltage regulation (AVR) topology saves battery power for deep voltage sag situations
- Sine wave output
- User replaceable, "hot swappable" batteries
- USB communications port
- Built-in surge protection
- Cold start capability
- Power Management software is included (UPSMON)
- 50/60 Hz auto sensing
- Protects against most adverse power conditions including: frequency variations, sags, blackouts, surge, spike and over and under voltages
- Two year limited warranty

Uninterruptible Power Supplies

S4K2U-C AND S4K2U-5C INDUSTRIAL ON-LINE SERIES



FEATURES

- Small 2U height maximizes available space
- Hardwire capability allows for permanent installation in rugged industrial environments
- Flexible; includes rack or tower mounting accessories standard with each unit
- Easy-to-connect add on batteries for extended runtimes
- User replaceable, "hot swappable" batteries
- Automatic and manual battery test
- Integral dynamic bypass reduces shutdowns
- Compatible with most standby generators
- Input and output noise suppression
- ABS Type Approval
- Two year limited warranty

The true On-Line, double conversion protection offered by the S4K Industrial UPS Series eliminates an extensive range of potential power problems, such as spikes, surges, extended overvoltage, transient noise, sags and extended brownouts. The S4K also protects equipment from difficult-to-track harmonics and dangerous frequency variations that are common with standby generator operation.

APPLICATIONS

- Robotics and process controls
- Industrial automation systems
- Network servers
- Enterprise telecommunication systems
- Printing and publishing machinery
- Industrial and commercial machinery

RELATED PRODUCTS

- CVS Hardwires and Portable MCR Power Conditioners
- Surge Protective Devices
- SolaHD Tracking Filters

Notes:

- EAC applies only to certain CE models.

S4K-C 6 KVA AND 10 KVA INDUSTRIAL ON-LINE UPS



FEATURES

- True double conversion topology
- Models offer 208/120 V or 240/120 V
- 4K5U-5C and 6 kVA international features flexible output voltages (208/220/230/240 V)
- Configurable as a tower or rack mount
- User replaceable, "hot swappable" batteries
- Extended battery cabinets available
- Includes both automatic and manual maintenance bypass switch
- Automatic frequency detection (60 or 50 Hz)
- Power Factor Correction
- Remote Emergency Power Off (REPO)
- Intellislot Communication port
- Two year limited warranty

The S4K-C 6 kVA and 10 kVA Industrial UPS Series are the first true On-Line industrial UPS that provide flexible output voltage, an integrated maintenance bypass switch and internal batteries all in slim 4U (7.0"); 5U (8.7") enclosure and 6U (10.5") enclosures respectively.

APPLICATIONS

- Robotics and process controls
- Industrial automation systems
- Network servers
- Printing and publishing machinery
- Industrial and commercial machinery
- Pharmaceutical and medical diagnosis equipment

RELATED PRODUCTS

- Portable MCR Power Conditioners
- Surge Protective Devices
- SolaHD Tracking Filters

Notes:

- EAC applies only to certain CE models.

Uninterruptible Power Supplies

S5KC MODULAR SERIES



The S5KC Modular Series was designed to be fully configured, tested and shipped in the configuration you need. It is scalable from 5 to 20 kVA. The optional N+x redundancy provides a fault-tolerant group of power modules and controls. Each modular component can be hot-swapped making it easy to increase power or extend back-up runtime without interrupting power to the load.

FEATURES

- Rugged, industrial design
- High overload capability
- 0.9 power factor
- Independently controlled maintenance bypass
- True On-Line double conversion with a large input voltage range
- ABS Type Approval
- Two year limited warranty

APPLICATIONS

- Network servers
- Enterprise telecommunications systems
- LAN gateways, bridges and routers
- Mini-computers, superservers and server clusters
- Clusters of PCs or workstations and peripherals
- RAID arrays and other large-scale data handling systems

RELATED PRODUCTS

- STV100K Surge Protective Device
- Isolation Transformers

Notes:

- EAC applies only to certain CE models.

Transformers



Reliably converting the voltage coming into facilities is essential to keeping equipment and plants running smoothly. Procuring, installing, and maintaining transformers that safely and efficiently deliver proper voltages can be a challenge.

Emerson offers a broad range of SolaHD transformers for applications across manufacturing facilities. Our distribution and automation transformers cover general purpose, low temperature rise, K-Factor, copper wound, hazardous location, buck-boost, drive isolation and industrial control applications with proven technologies and industry standard certifications. Picking the right transformer from this group depends on the load, temperature, space or usage conditions. Because these environmental factors can drastically affect transformer performance, custom transformers are also available for specialty applications that require unique sizes and performance capabilities. We are ready to help you specify the right SolaHD transformer design with an experienced Technical Support team and online resources.

Transformers

DRIVE ISOLATION TRANSFORMERS: 7.5-440 KVA, THREE PHASE



Drive Isolation Transformers are specifically designed to handle the mechanical stresses, voltage demands and harmonics associated with DC, SCR drive applications.

APPLICATIONS

- SCR variable speed drives

RELATED PRODUCTS

- Surge Protective Devices
- K-Rated Transformers for Variable Frequency Drives

FEATURES

- Available from 7.5 thru 440 kVA, three phase, 60 Hz
- Isolation minimizes load disturbances caused by the SCR drive
- UL Listed/NEMA Type 3R enclosures when used with optional weather shield
- Taps on all units for adjustments to incoming source voltage
- Full capacity secondary neutral as required by the National Electric Code
- Shielding attenuates line to ground noise
- Ten year limited warranty

SMT SERIES – ALUMINUM WOUND, OPEN STYLE: 1000-5000 VA



The SMT Series is economical and compact with traditional open wound varnished coils. It features a class +180 °C (+356 °F) insulation system and +115 °C (+239 °F) temperature rise under full load. SMT transformers provide excellent cost benefits with NEMA regulation characteristics and electrical performance specifications.

APPLICATIONS

- Industrial/machine control
- Process control
- Material handling
- Conveying equipment
- Vending machines
- Packaging equipment
- Amusement park equipment
- Semiconductor fabrication equipment

RELATED PRODUCTS

- Linear Power Supplies
- DIN Rail DC Power Supplies
- Constant Voltage Transformers

FEATURES

- Available from 1000–5000 VA, 60 Hz unless noted
- Meets or exceeds electrical requirements of NEMA, ANSI, NMTBA and JIC

Transformers

SBE ENCAPSULATED CONTROL TRANSFORMERS: 50 – 1000 VA



SBE Industrial Control Transformers are epoxy encapsulated to seal the transformer windings against moisture, dirt and industrial contaminants. Extra deep, molded terminal barriers reduce the chance of electrical failure resulting from arcing or frayed lead wires. The rugged construction and proven reliability of the SBE design is uniquely suited for all industrial environments.

FEATURES

- 50 - 1000 VA, 50/60 Hz – suitable for worldwide applications
- Interleaved copper windings reduce I²R losses and maximize efficiency
- +55 °C (+131 °F) temperature rise, +105 °C (+221 °F) insulation system to minimize heat
- Epoxy encapsulated to protect cores and coils against moisture, dirt and other contaminants
- Meets or exceeds NEMA Standard ST 1 and ANSI C89.1 for load inrush capability
- Integrally molded, flame retardant (IEC 707 / ISO Class 1210) Terminal Blocks provide greater terminal contact area and improved conductivity
- Ten year limited warranty

APPLICATIONS

- Industrial/machine control
- Process control
- Material handling
- Conveying equipment
- Vending machines
- Packaging equipment
- Amusement park equipment
- Semiconductor fabrication equipment

RELATED PRODUCTS

- Linear Power Supplies
- DIN Rail DC Power Supplies
- Constant Voltage Transformers

Note:

- CE is not available with fuse option.

SBE COPPER WOUND, OPEN STYLE: 1500 – 5000 VA



The open style SBE Series provides voltage regulation in excess of NEMA recommendations without exceeding +55 °C (+131 °F) temperature rise. These higher power capacity transformers are the best choice when 80% or more of the load components are electromagnetic devices.

FEATURES

- Interleaved copper windings reduce I²R losses and maximize efficiency
- Ratings 60 Hz unless noted 50/60 Hz
- Meets or exceeds electrical requirements of NEMA, ANSI, NMTBA and JIC
- +55 °C (+131 °F) temperature rise, +105 °C (+221 °F) insulation system
- High quality silicon steel core

APPLICATIONS

- Industrial/machine control
- Process control
- Material handling
- Conveying equipment
- Vending machines
- Packaging equipment
- Amusement park equipment
- Semiconductor fabrication equipment

RELATED PRODUCTS

- Linear Power Supplies
- DIN Rail DC Power Supplies
- Constant Voltage Transformers

Transformers

ICE INTERNATIONAL SERIES: 750 – 2000 VA



International CE marked transformers include IP20 touchproof terminations and copper windings in an encapsulated design. The design is highly flexible due to the use of the standardized primary coil for multiple worldwide voltage combinations.

FEATURES

- IP20 touch-proof terminals
- Copper windings
- Epoxy encapsulated for cooler operation and increased reliability
- +80 °C (+176 °F) temperature rise, +130 °C (+266 °F) insulation system for harsh, heavy-duty standards
- 50/60 Hz Frequency
- Meets or exceeds electrical requirements of NEMA, ANSI and IEC

APPLICATIONS

- Industrial/machine control
- Process control
- Material handling
- Conveying equipment
- Vending machines
- Packaging equipment
- Amusement park equipment
- Semiconductor fabrication equipment

RELATED PRODUCTS

- DIN Rail Power Supplies
- 63 Series Power Conditioners
- Surge Protective Devices

HSZ SERIES INDUSTRIAL CONTROL TRANSFORMERS: 1000 - 10,000 VA



The HSZ Series of industrial control transformers is designed for applications where cost or heat issues require the transformer to be mounted outside of the control panel.

FEATURES

- UL Class +180 °C (+356 °F) insulation system, +80 °C (+176 °F) temperature rise under full load
- Meets or exceeds NEMA regulation standards
- Copper windings
- Encapsulated

APPLICATIONS

- Industrial/machine control
- Process control
- Material handling
- Conveying equipment
- Vending machines
- Packaging equipment
- Amusement park equipment
- Semiconductor fabrication equipment

RELATED PRODUCTS

- Linear Power Supplies
- DIN Rail DC Power Supplies
- Constant Voltage Transformers

Transformers

LOW VOLTAGE GENERAL PURPOSE TRANSFORMERS



Our transformers have provided distributed power in the most demanding environments for over 90 years. They feature full isolation with shielding and NEMA 3R, NEMA 4/12 and NEMA 4X stainless steel optional enclosures.

APPLICATIONS

- Office/commercial buildings
- Shopping centers
- Municipal/institutional buildings
- Hospitals

FEATURES

- UL Listed/NEMA Type 3R ventilated outdoor enclosures when used with optional weather shields (order separately)
- UL Class +220 °C (+428 °F) insulation system, +150 °C (+302 °F) temperature rise under full load
- Terminal board connections and spacious wiring compartment
- Panel enclosure design reduces labor time, wiring diagram on inside front cover
- High efficiency for low cost operation
- Compliant to DOE 2016 Standards
- Single and three phase availability
- Fast delivery
- Ten year limited warranty

K-FACTOR TRANSFORMERS



K-Factor Transformers are designed to reduce the heating effects of harmonic currents. The K-Factor rating is an index of the transformer's ability to withstand harmonic content while operating within the temperature limits of its insulating system. K-Factor transformers have UL ratings of K-4, K-13, and K-20.

FEATURES CONTINUED

- Core and coil design engineered to manage the zero sequence flux caused by triple harmonics
- Provides 100% rated current without overheating the windings or saturating the core
- Compliant to DOE 2016 Standards

APPLICATIONS

- Telecommunications equipment
- Uninterruptible power supplies (UPS)
- Solid state motor drives
- Variable Frequency Drive (VFD) - AC

RELATED PRODUCTS

- DIN Rail DC Power Supplies
- Constant Voltage Transformers

FEATURES

- Conductors to carry harmonics of a K-rated load without exceeding insulation temperature ratings
- UL 1561 listed up to K-20 rated protection
- Rated temperature rise of +150 °C (+302 °F), +220 °C (+428 °F) insulation system
- Shielded for quality power
- Basic design takes "stray losses" into account and functions within safe operating temperatures

Transformers

AUTOMATION, NON-VENTILATED TRANSFORMERS

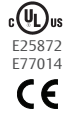

FEATURES

- Encapsulated (suitable for hazardous locations)
- Single phase: .05 – .25 kVA and .50 – 25 kVA; Three phase: 3 – 150 kVA
- Electrostatically shielded for quality power on sizes 1 kVA and larger
- UL Class +200 °C (+392 °F) insulation system, +115 °C (+239 °F) temperature rise under full load
- Conduit knockouts for side entry into wiring compartment
- .50 – 45 kVA units are encapsulated with electrical grade silica and epoxy for industrial applications
- Floor Mount 15 kVA to 150 kVA encapsulated transformers with Gland Plates; UL Listed/NEMA Type 1, 2, 3R, 4, and 12 encapsulated enclosure for indoor and outdoor service

Encapsulated transformers are rated for use in hazardous locations as well as harsh industrial environments. Encapsulation and rugged NEMA 3R enclosures protect the transformer from dust and moisture while providing extra shock and vibration resistance. UL Listed transformers fully comply with the latest edition of the National Electrical Code for Class I, Division 2, Group A, B, C, D locations when installed in compliance with NEC 501.100(B) and rated transformers for use in Class I, Division 2/Zone 2 hazardous locations.

APPLICATIONS

- Industrial plants
- Chemical processing plants
- Water/wastewater facilities
- OEM equipment
- Semiconductor fabrication equipment

RELATED PRODUCTS

- DIN Rail DC Power Supplies
- Constant Voltage Transformers

Note: CE applies only to certain models.

BUCK-BOOST TRANSFORMERS



FEATURES

- Hardshell® encapsulated on sizes 5 kVA and below
- UL-3R enclosures for indoor or outdoor service (some sizes may require the use of weathershields)
- Low cost, smaller, lighter, more efficient to operate than equivalent isolation transformers

These small, single phase, dry type distribution transformers are designed and shipped as insulating/isolating transformers. They have a dual voltage primary and secondary that can be connected for a wide range of voltage combinations. The most common use is to buck (lower) or boost (raise) the supply voltage a small amount, usually 5 to 27%. Buck-boost transformers are in compliance with NEC Article 210-9, Exception 1 when field connected as an autotransformer.

APPLICATIONS

- Motor loads
- HVAC
- Low voltage lighting (when used as an Isolation transformer)
- Sustained high or low voltage conditions

RELATED PRODUCTS

- Surge Protective Devices
- SolaHD Tracking Filters

Power Supplies



If it uses electrical power, it is probably going to be subjected to voltage sags. These momentary losses of line voltage are one of the most frequent power quality disturbances found in industrial facilities. Normally caused internally by large load start-ups or externally by utility switching, voltage sags prematurely wear machines and computer equipment. The result can be lost data, inexplicable resets or a production shutdown. Most motors, lighting and indicators have some built-in resistance to sags. However, the AC/DC power supply used to power all DC control and logic circuits are often very vulnerable.

The legacy of Emerson's SolaHD brand is rooted in their renowned power supply solutions. Our SolaHD products enable production facilities to safeguard almost any equipment application with a complete line of switching and linear power supply technologies. The SDN-D Series offers extreme reliability and efficiency, easy troubleshooting and access to a wealth of information through optional network communication modules. Both the SDN-D Series and SDN-C Series are designed for use in harsh environments, extreme temperatures and hazardous locations. The SDN-P™ and SDP™ Series industrial grade power supplies are designed for use in environments subject to rugged conditions, wide temperature ranges and power quality issues. When your equipment is installed in a controlled environment, the SVL Series converts AC to DC power in a compact footprint. We understand the flexibility requirements of today's modular production lines. That is why we offer a wide selection of SolaHD DIN rail mountable power supplies for fast installations and reconfigurations.

Power Supplies

IP67 SCP-X EXTREME ENVIRONMENT SERIES



UL US
E61379
E137632



FEATURES

- IP66/67 rated power supplies can be mounted anywhere, no enclosure necessary
- 240 Watt, 24 Vdc, 10 Amp single output, with 150% inductive load power boost for 4 seconds
- 24 Vdc, 100-240 Vac, up to four outputs at 3.8 Amp Nominal Current (per pair for dual models)
- DC OK Relay connector for providing diagnostic status information to a PLC or other controller
- Class II power supplies can be mounted in any orientation without limitation
- Safety approved for AC and DC universal input
- Reliable operation from -40 °C to +60 °C (-40 °F to +140 °F) without derating
- DC OK Green LED
- Worldwide approvals
- Five year limited warranty

APPLICATIONS

- Industrial/machine control
- Process control
- Conveying equipment
- Material handling
- Vending machines
- Packaging equipment
- DeviceNet™
- Amusement park equipment
- Semiconductor fabrication equipment

RELATED PRODUCTS

- SDN Series
- SDN DeviceNet™ Series

The IP67 SCP-X power supplies provide the versatility and cost-efficiency to deliver reliable distributed and remote field power to machine controls. Mounts directly on the machine or production line eliminating the complexity and cost of unnecessary enclosures and excess wiring. Quick change connectors simplify connectivity for distributed I/O devices on industrial machinery. This also minimizes Personal Protective Equipment (PPE) requirements that are often necessary when accessing a traditional DIN rail power supply in an enclosure with exposed AC power. Class II Listed, 24 Vdc power supplies are available in single and dual 100 Watt models are perfect for automotive, packaging and automated distribution applications. A 240 Watt 10 Amp model is also available for powering larger loads, with 150% short-term Power Boost for supporting inductive loads.

SEALED POWER SUPPLY PRODUCES GREATER COST AND OPERATIONAL EFFICIENCIES

More and more facilities are turning toward “distributed field power” for machine device control and communication. This has created the need for powerful and efficient field power supplies that can stand up to the heat, water, dust and other performance-robbing conditions of industrial environments.

Typical power supplies have addressed these issues by being mounted inside large and expensive specially-rated enclosures that are located away from the production equipment. Power is routed from the enclosure to the machines via cabling, which creates issues with reliability, maintenance and operator safety.

DEVELOPED SPECIFICALLY FOR THE DEMANDS OF MANUFACTURING

The SolaHD IP67 SCP-X was designed from the ground up specifically for today’s “distributed field power” plant designs. This stand-alone, self-protected unit eliminates the expense and bulk of non-ventilated enclosures with a rugged housing that can withstand shocks up to 3G’s and IP67 ingress protection. The IP67 SCP-X was also engineered with thermal management capabilities that eliminate the need for fans or exterior ventilation. The unit’s passive convection cooling efficiencies are so high, only one inch of free space is required on the sides and front of the unit.

These capabilities allow the IP67 SCP-X to be mounted directly onto machines. No expensive separate enclosures are needed. Also less cabling is required between the power supply and the power consuming devices on the machine resulting in cost savings, safer operation and faster installation and maintenance.

Power Supplies

SDN-D HIGH PERFORMANCE DIN RAIL SERIES



In spite of its small size, the SDN-D high performance DIN rail power supply boasts one of the highest efficiencies available in the market today. Higher efficiency means less heat is generated, potentially extending the life of all components in the enclosure. Extensive diagnostic monitoring capabilities are possible with the optional SCM network communication module, which utilizes popular industrial network protocols to provide critical power supply data to computers, PLCs, DCSs, HMIs and other devices.

FEATURES

- High performance unit in a compact package
- Optional network communications modules provides important diagnostic information to controllers, HMI and computers
- Multi-turn potentiometer simplifies accurate setting of output voltage
- Extensive international hazardous location certifications, including Class I Zone 2, ATEX, and IECEx. Hazardous location temperature code (T-Code) rating of T4
- Inductive Load Power Boost additional short term power, to assist in starting loads with high inrush current
- Dual output terminals for convenience in wiring

APPLICATIONS

- Industrial automation
- Process control
- Conveying equipment
- Material handling
- Hazardous Locations

RELATED PRODUCTS

- IP67 SCP-X Standalone Power Supplies
- SDU UPS

SDN-C COMPACT DIN RAIL SERIES



The SDN-C Series is suitable for the most extreme environments, including hazardous locations and off-shore applications. Features like wide operating temperature range, power boost capability, and adjustable output voltage ensure reliable operation in the harshest industrial environments. Parallel operation, extensive LED diagnostics, and universal AC or DC input voltage simplify installation and maintenance. For added reliability, the SDN-C power supplies can be used with the SolaHD Redundancy modules to provide redundant power supply operation.

FEATURES

- Compact packaging saves space on the DIN rail
- >90% efficiency
- Accepts Universal voltage 85 - 264 Vac, 50/60 Hz input
- High MTBF and reliability
- Single phase models meet SEMI F47 Sag Immunity standard
- Active power factor correction on most models
- Parallel operation capability standard
- Fully tested and burned-in at factory
- ABS Type Approval
- User adjustable output voltage accessible via front face

APPLICATIONS

- Industrial/machine control
- Process control
- Conveying equipment
- Material handling
- Vending machines
- Packaging equipment
- Amusement park equipment
- Semiconductor fabrication equipment

RELATED PRODUCTS

- SDN-C Redundancy Modules
- IP67 SCP-X Extreme Environment Series
- SDU UPS

Power Supplies

SDN-P DIN RAIL SERIES



FEATURES

- 60 to 240 Watts, single models
- PowerBoost™ — Powers high inrush loads without shutdown or foldback
- Auto select or universal input for no manual switching
- Industrial-grade design
- -10 °C to +60 °C (+14 °F to +140 °F) operation without derating
- Indefinite short circuit, overvoltage and overtemperature protection
- Rugged metal case and DIN rail clips
- NEC Class 2 rating on SDN4-24-100LP and SDN2.5-24-100P
- Narrow width on rail for space critical applications
- High MTBF and reliability
- Limited five year warranty

The SDN-P Series combines industry leading performance with a true industrial grade design. These high quality units meet difficult industrial environmental conditions including high shock, vibration, and wide temperature ranges over the long life cycle of industrial equipment.

APPLICATIONS

- Industrial/machine control
- Process control
- Material handling
- DeviceNet™ Ethernet

RELATED PRODUCTS

- SVL Series
- SDP™ Series
- SCL Series
- SCP Series
- SDU UPS

SVL ESSENTIAL DIN RAIL SERIES



FEATURES

- Universal Input
- Convection cooling
- Protection
 - Short Circuit
 - Overload
 - Over Voltage
 - Over Temperature
- DC OK LED
- Blinking OCP Diagnostic
- DC OK Relay for >120 Watts models
- Two year warranty

SVL Series power supplies are perfect for high volume, controlled environment applications where essential features are the only requirement. When space inside an enclosure is at a premium, their small footprint makes these power supplies an excellent alternative to embedded open frame switchers. The DIN rail mounting capability provides quicker and easier installation while allowing for design flexibility. These power supplies range from 15 to 480 Watts in 5, 12, 24 and 48 Volt combinations.

APPLICATIONS

- Test and Measure Equipment
- Scanners
- Instrumentation
- Printers Peripheral
- ATM Machines
- Semiconductor Fabrication Equipment
- Vending Machines

RELATED PRODUCTS

- SDN-C Series
- SDN-P Series
- SDP™ Series

Power Supplies

SDP™ LOWER POWER DIN RAIL SERIES



The SDP Series ranges in output voltages from 5 Vdc to 48 Vdc and features power ratings from 15 to 100 Watts. These efficient units are designed specifically for the industrial environment where space is limited. Each unit is rated from -10 °C to +60 °C (+14 °F to +140 °F) with no derating.

FEATURES

- Adjustable output
- No tools required for mounting
- PowerBoost™ industrial overload design
- Overvoltage, short circuit protection
- Class 2 Limited Power Source for building automation or DeviceNet™
- Continuous short circuit protection
- Low output noise
- Screw terminal connections
- Limited three year warranty

APPLICATIONS

- Industrial/machine control
- Process control
- Building automation
- Instrumentation

RELATED PRODUCTS

- SDN Series
- SCP Series

SDN SERIES REDUNDANT OPTIONS



With the addition of an external redundancy module the SDN-D and SDN-C can also be used for true redundant operations.

FEATURES

- Smart power “DC OK Relay Contact”
- Redundant power supply operation with true isolation
- Extensive diagnostics
- Load balancing support extends power supply life
- Use in hazardous locations, with T4 temperature rating
- Works with a wide variety of power supplies
- High availability
- SDN features and quality
- ABS Type Approval
- Limited five year warranty

APPLICATIONS

- Hazardous locations
- Process control
- Remote location
- Critical production

RELATED PRODUCTS

- SDN-D Series
- SDN-C Series

Power Supplies

SCP SERIES, 30 WATT: SINGLE, DUAL AND TRIPLE



FEATURES

- International approvals for global use
- Rugged, encapsulated design to resist environment
- IP20 protection
- Many output voltages (3.3-48 Volts; single, dual, triple)
- SCP-MDC - Pair of metal DIN clips
- SCP-PDC - One plastic DIN clip with lever for removal from rail
- UL 60950, E137632, EN60950, and IP20
- Limited five year warranty

The SCP Series' compact, rugged switchers are designed to power many of your industrial control and instrumentation devices and equipment. These units provide high reliability and tight regulation through the most difficult factory-floor conditions around the globe. These unique "User friendly" power supplies feature easy-to-install DIN rail and chassis mounting. Terminations are also easy to access (AC and DC terminations are well separated) and simple to wire. The encapsulated design meets IP20 specifications, and the wide range of voltages will reliably support almost any low-power device in your cabinet or system.

APPLICATIONS

- Industrial/machine control
- Process control
- Material handling
- Conveying equipment
- Vending machines
- Packaging equipment
- Amusement park equipment
- Semiconductor fabrication equipment

RELATED PRODUCTS

- SDN Series
- SDPT™ Series
- STFE Elite Series

SCD SERIES, ENCAPSULATED, INDUSTRIAL DC TO DC CONVERTER



FEATURES

- DIN rail or chassis mount by removing DIN clips
- Rugged, encapsulated design to resist environment
- IP20 protection
- Wide 20 to 72 Vdc input range
- M3 screw clamp terminations
- Simple snap-on for DIN rail TS35/7.5 or TS35/15
- Galvanic isolation
- Limited five year warranty

The SCD Series is a compact, rugged DC to DC converter designed to power industrial control instrumentation devices and equipment where AC power is not convenient or accessible. With high reliability and a wide input range, these units can operate through the most difficult factory floor conditions around the globe.

APPLICATIONS

- Industrial – encoders, special sensors, communications and instrumentation
- Telecommunications systems
- Remote site/harsh environment

RELATED PRODUCTS

- SDN Series
- SDPT™ Series
- STF Series

SolaHD understands that your operation depends on clean, continuous power.



Our full breadth of products convert, clean and maintain electric current from the factory entrance to equipment throughout your facility. Combined with service and support, our total power quality offering can save you time, money and space to ensure optimal production or facility efficiencies.

 solahd.com

 [LinkedIn.com/company/emerson](https://www.linkedin.com/company/emerson)

The Emerson logo is a trademark and service mark of Emerson Electric Co. SolaHD is a registered trademark of Appleton Grp LLC. All other marks are the property of their respective owners. © 2023 Emerson Electric Co. All rights reserved.



CONSIDER IT SOLVED™