

# AMS Asset Monitor

VI Piezo CHARM



## Copyright

© 2022 by Emerson. All rights reserved.

No part of this publication may be reproduced, transmitted, transcribed, stored in a retrieval system, or translated into any language in any form by any means without the written permission of Emerson.

## Disclaimer

This manual is provided for informational purposes. EMERSON MAKES NO WARRANTY OF ANY KIND WITH REGARD TO THIS MATERIAL, INCLUDING, BUT NOT LIMITED TO, THE IMPLIED WARRANTIES OF MERCHANTABILITY AND FITNESS FOR A PARTICULAR PURPOSE. Emerson shall not be liable for errors, omissions, or inconsistencies that may be contained herein or for incidental or consequential damages in connection with the furnishing, performance, or use of this material. Information in this document is subject to change without notice and does not represent a commitment on the part of Emerson. The information in this manual is not all-inclusive and cannot cover all unique situations.

## Patents

The product(s) described in this manual are covered under existing and pending patents.

-  Vermerk zur Installation der Messketten in explosionsgefährdeter Umgebung.  
Soll die Messkette in explosionsgefährdeter Umgebung installiert werden, so ist auf die Einhaltung der in der Gebrauchsanweisung enthaltenen Installationshinweise zu achten. Sollten dabei sprachliche Schwierigkeiten auftreten, wenden Sie sich bitte an die Herstellerfirma, sie wird Ihnen eine Übersetzung der relevanten Artikel in der Landessprache des Verwendungslandes zukommen lassen.
-  Nota fuq l-installazzjoni tal-ktajjen tal-kejl f'ambjent esploziv  
Jekk il-katina tal-kejl suppost li tigi installata f'ambjent esploziv, hu importanti li ssegwi l-istruzzjonijiet pertinenti tal-manwal. Jekk issib xi diffikultà bil-lingwa, jekk joghgbok ikkuntattja lill-manifattur biex tikseb traduzzjoni tal-paragrafi rilevanti fil-lingwa mehtiega.
-  Anmärkning beträffande installation av mätkedjorna i explosionsfarlig miljö.  
Ska mätkedjan installeras i explosionsfarlig miljö, måste de anvisningar följas som ges i instruktionsboken beträffande installationen. Skulle därvid språkproblem uppstå, ber vi dig kontakta det tillverkande företaget som då kommer att sända dig en översättning av de relevanta artiklarna på användningslandets språk.
-  Opomba za namestitve merilne verige v eksplozivno ogroženem okolju  
Èe se merilna veriga namešèa v eksplozivno ogroženem okolju, je potrebno upoštevati namestitvena opozorila, ki so v Navodilih za uporabo. Èe se pri tem pojavijo jezikovne težave, se posvetujte z izdelovalcem; poslali vam bodo prevod ustreznih èlankov v jeziku države, kjer se naprava uporablja.
-  Záznam k inštalácii meracích reťazcov vo výbušnom prostredí  
Ak má byť merací reťazec inštalovaný vo výbušnom prostredí, treba dbať na dodržiavanie pokynov k inštalácii, uvedených v návode na použitie. V prípade, že by sa pritom vyskytli jazykové problémy, obráťte sa prosím na výrobcu, ktorý Vám zašle preklad relevantných èlánkov v jazyku Vašej krajiny.
-  Nota referente à instalação de cadeias de agrimensur em ambientes potencialmente explosivos  
Caso a cadeia de agrimensur deva ser instalada em um ambiente potencialmente explosivo, é imprescindível observar e cumprir as indicações de instalação das instruções de serviço. Caso tenha dificuldades idiomáticas, queira entrar em contato com a firma produtora, esta poderá enviar-lhe uma tradução dos capítulos mais importantes no idioma do país onde o produto deverá ser empregado.
-  Wskazówka dotycząca instalacji łańcuchów mierniczych w otoczeniach zagrożonych eksplozją.  
Jeżeli łańcuch mierniczy ma być zainstalowany w otoczeniu zagrożonym eksplozją, należy uwzględnić wskazówki dotyczące instalacji, które są zawarte w instrukcji obsługi. Jeżeli w trakcie lektury wystąpią jakiegokolwiek problemy związane ze zrozumieniem tekstu, prosimy zwrócić się do producenta, który chętnie wykona tłumaczenie wybranych części dokumentacji na język danego kraju.



Opmerking m.b.t. installatie van elektrische meet circuits in explosiegevaarlijke omgeving

Dient de installatie van elektrische meet circuits in een explosiegevaarlijke omgeving te geschieden, moet men toezien dat de in de gebruikshandleiding opgenomen installatieinstructies worden nageleefd. Bij taalkundige problemen gelieve contact op te nemen met de fabrikant, deze zal u vervolgens een vertaling in de taal van het gebruiksland doen toekomen.



Pastaba dėl matavimo grandinės įrengimo sprogimo atžvilgiu pavojingoje aplinkoje

Jei matavimo grandinė turi būti įrengta sprogimo atžvilgiu pavojingoje aplinkoje, privaloma laikytis vartotojo instrukcijoje pateiktų įrengimo nurodymų. Jei kiltų sunkumų dėl kalbos, prašome kreiptis į gamintojo įmonę, kuri pateiks Jums reikiamo skyriaus vertimą į vartotojo valstybės kalbą.



Nota sull'installazione delle catene per misurazione in ambienti a rischio di esplosioni

Nel caso in cui si debbano installare le catene per misurazione in ambienti a rischio di esplosioni, è necessario attenersi alle avvertenze per l'installazione contenute nelle istruzioni d'uso. Per difficoltà di carattere linguistico, rivolgetevi alla ditta produttrice. Quest'ultima Vi farà pervenire una traduzione degli articoli rilevanti nella lingua del paese d'impiego.



Megjegyzés a mérőláncok robbanásveszélyes környezetben történő szereléséhez.

Ha a mérőláncot robbanásveszélyes környezetben kell felszerelni, akkor ügyeljen a Használati útmutatóban közölt szerelési utasítások betartására. Amennyiben nyelvi nehézségek merülnek fel, szíveskedjen a gyártó céghez fordulni, amely elküldni Önnek a felhasználó ország nyelvére lefordított, erre vonatkozó cikket.



Remarque concernant l'installation des chaînes de mesure dans un environnement présentant un risque d'explosion

Si la chaîne de mesure doit être installée dans un environnement présentant un risque d'explosion, il est impératif de veiller à respecter les consignes d'installation contenues dans les instructions de service. S'il devait ce faisant surgir des problèmes linguistiques, veuillez vous adresser à la société fabricante: elle vous fera parvenir une traduction des articles significatifs dans la langue du pays de mise en oeuvre.



Huomautus mittausketjun asentamisesta räjähdysalttiissa ympäristössä

Jos mittausketju tulee asentaa räjähdysalttiissa ympäristössä, on käyttöohjeessa annettuja asennusohjeita noudatettava. Jos käyttöohjeessa käytetty kieli aiheuttaa ongelmia, kääntykää valmistajayrityksen puoleen. Se toimittaa käyttöönnne tarvittavat artikkelit käyttömaan viralliselle kielelle käännettynä.



Juhend mõõdukettide ülespanemiseks plahvatusohtlikus piirkonnas.

Kui panna üles mõõdukettid plahvatusohtlikkus piirkonnas, nii tuleb jälgida kasutusjuhendis sisalduvad instalationimärkmeid. Juhul kui tekkivad raskused keelega, siis pöörduge palun tootja poole. Tootja saadab emakeelse tõlge vastavalt artiklile ning maale.



Notas sobre la instalación de cadenas de medición en un entorno potencialmente explosivo.

Si ha de instalar la cadena de medición en un entorno potencialmente explosivo, deberá respetar las indicaciones sobre la instalación, contenidas en el manual de uso. Si surgieran dificultades lingüísticas, póngase en contacto con la empresa fabricante, que le facilitará una traducción del artículo en la lengua del país donde se emplee.



Note on the installation of the measuring chains in an explosive environment

If the measuring chain is supposed to be installed in an explosive environment, it is important to follow the pertinent installation instructions in the manual. Should you encounter difficulties with the language, please contact the manufacturer to obtain a translation of the relevant paragraphs into the language required.



Σημείωση για την εγκατάσταση αλυσίδων μέτρησης σε περιβάλλον, στο οποίο υπάρχει κίνδυνος έκρηξης  
Εάν η αλυσίδα μέτρησης πρόκειται να εγκατασταθεί σε περιβάλλον, στο οποίο υπάρχει κίνδυνος έκρηξης, πρέπει να τηρηθούν οπωσδήποτε οι οδηγίες εγκατάστασης που περιλαμβάνονται στις οδηγίες Χρήσης. Εάν υπάρχουν γλωσσικές δυσκολίες καταούησης, παρακαλούμε να απευθυνθείτε στην κατασκευάστρια εταιρεία, η οποία θα φρουτίσει για την αποστολή μιας μετάφρασης τωv σχετικωv άρθρωv στη γλωσσα της Χωρας Χρήσης.



Info vedrørende installation af målekæderne i eksplosionstruede omgivelser

Hvis målekæden skal installeres i eksplosionstruede omgivelser, skal installationsanvisningerne i brugsanvisningen følges. Hvis der i denne forbindelse opstår sproglige problemer, bedes De henvende Dem til produktionsfirmaet, som så vil sørge for, at De modtager en oversættelse af den relevante artikel på Deres sprog.



Poznámka k instalaci měřicích řetězců v prostředí s nebezpečím výbuchu.

Když má být měřicí řetězec (sestavující z čidla a konvertoru) instalován v prostředí s nebezpečím výbuchu, tak je třeba respektovat instalační pokyny, které jsou součástí návodu k upotřebení. Kdyby při tom došlo k jazykovým potížím, tak prosíme kontaktujte výrobní firmu, která Vám relevantní článek zašle v jazyku krajiny použití.



Piezīme par mērišanas ķēžu instalēšanu sprādziena bīstamās zonās.

Ja mērišanas ķēde jāuzstāda sprādzienbīstamā zonā, ir jāievēro lietošanas instrukcijā dotie instalēšanas norādījumi. Ja rodas kādas valodas grūtības, lūdzu griezties pie izgatavotāja firmas, kas Jums nosūtīs nozīmīgāko nodaļu tulkojumus lietotāja valsts valodā.

Emerson  
epro GmbH  
Jöbkesweg 3  
48599 Gronau  
Germany  
T +49 2562 709 0  
F +49 2562 709 401  
www.Emerson.com

# Contents

<b>Chapter 1</b>	<b>General.....</b>	<b>7</b>
	1.1 About this manual.....	7
	1.2 Symbols.....	7
	1.3 Liability and guarantee.....	8
	1.4 Incoming goods inspection.....	8
	1.5 Technical support.....	9
	1.6 Storage and transport.....	9
	1.7 Disposal of the device.....	9
	1.8 China RoHS Compliance.....	10
	1.9 Installation awareness.....	10
<b>Chapter 2</b>	<b>Safety instructions.....</b>	<b>11</b>
	2.1 Using the device.....	11
	2.2 Owner's responsibility.....	11
	2.3 Radio interference.....	11
	2.4 ESD safety.....	12
<b>Chapter 3</b>	<b>Installing the Piezo CHARM hardware.....</b>	<b>13</b>
	3.1 About the VI Piezo CHARM hardware.....	13
	3.2 Install the VI Piezo CHARM.....	13
<b>Chapter 4</b>	<b>Remove the CHARM.....</b>	<b>17</b>
<b>Chapter 5</b>	<b>Maintenance, troubleshooting, and repair.....</b>	<b>19</b>
	5.1 Maintenance.....	19
	5.2 Troubleshooting.....	19
	5.3 Repair.....	21
	5.4 Replace a VI Piezo CHARM.....	21
<b>Chapter 6</b>	<b>Technical data.....</b>	<b>23</b>
	6.1 Electrical data.....	23
	6.2 Environmental conditions and mechanical design.....	23
<b>Chapter 7</b>	<b>Certificates.....</b>	<b>25</b>



# 1 General

## 1.1 About this manual

This manual contains specifications, wiring diagrams, dimensions, and step-by-step instructions for installing the VI Piezo CHARM.

Read this guide completely prior to starting installation of the device. Comply with all safety instructions.

This installation guides applies to VI Piezo CHARMS with a hardware revision listed in [Table 1-1](#). See type plate for revision level.

**Table 1-1: Hardware revision**

Component	Revision
VI Piezo CHARM	07, 08

Include the installation guide when transferring the device to third parties.

---

### Note

When requesting technical support, indicate type and serial number from the type plate.

See [Table 1-2](#) for a list of documents referred to in this installation guide.

**Table 1-2: Referenced documents**

MHM Number	Document name
MHM-97924-PBF	Operating Manual AMS Asset Monitor
MHM-97923-PBF	Installation Guide AMS Asset Monitor

See [Table 1-3](#) for product type and ordering numbers of the hardware referred to in this installation guide.

**Table 1-3: Product type and ordering numbers**

Hardware	Product type number	Ordering number
VI Piezo CHARM	AM 5125	SE8701V01-PZ
Standard Terminal Block	KL4502X1-BA1	SE4501-RS

## 1.2 Symbols

---

### Note

This symbol marks passages that contain important information.



---

### ⚠ CAUTION

This symbol marks operations that can lead to malfunctions or faulty measurements, but will not damage the device.

### ⚠ DANGER

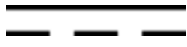
A danger indicates actions that can lead to property damage or personal injury.

	According to IEC 61010, this symbol means that this device must be operated with DC voltage.
	Warning, electric shock hazard.
	According to IEC 61010, this symbol means that the documentation of the device must completely be read and understood before installing and commissioning of the device. Observe all safety related instructions in this document.

## 1.3 Liability and guarantee

Emerson is not liable for damages that occur due to improper use. Proper use also includes the knowledge of, and compliance with, this document.

Customer changes to the device that have not been expressly approved by Emerson will result in the loss of guarantee.

Due to continuous research and further development, Emerson reserves the right to change technical specifications without notice.

## 1.4 Incoming goods inspection

Check the content of the shipment to ensure that it is complete. Inspect the goods to determine if the device has been damaged during transport. The following parts are included in the scope of delivery and must be contained in the shipment:

- VI Piezo CHARM

If the contents are incomplete, or if you observe any defects, file a complaint with the carrier immediately. Inform the responsible Emerson sales organization, so your device can be replaced. In this case, attach a tag with customer name and the observed defect.

Additional parts are required to use the VI Piezo CHARM, see [About the VI Piezo CHARM hardware](#) for details.



## 1.5 Technical support

You may need to ship this product for return, replacement, or repair to an Emerson Product Service Center. Before shipping this product, contact Emerson Product Support to obtain a Return Materials Authorization (RMA) number and receive additional instructions.

### Product Support

Emerson provides a variety of ways to reach your Product Support team to get the answers you need when you need them:

<b>Phone</b>	Toll free 800.833.8314 (U.S. and Canada) +1.512.832.3774 (Latin America) +63.2702.1111 (Asia Pacific, Europe, and Middle East)
<b>Email</b>	<a href="mailto:Guardian.GSC@Emerson.com">Guardian.GSC@Emerson.com</a>
<b>Web</b>	<a href="http://www.emerson.com/en-us/contact-us">http://www.emerson.com/en-us/contact-us</a>

To search for documentation, visit <http://www.emerson.com>.

To view toll free numbers for specific countries, visit <http://www.emersonprocess.com/technicalsupport>.

---

### Note

If the equipment has been exposed to a hazardous substance, a Material Safety Data Sheet (MSDS) must be included with the returned materials. An MSDS is required by law to be available to people exposed to specific hazardous substances.

---

## 1.6 Storage and transport

Store and transport the device only in its original packaging. Technical data specifies the environmental conditions for storage and support.

## 1.7 Disposal of the device

Provided that no repurchase or disposal agreement exists, recycle the following components at appropriate facilities:

- Recyclable metal
- Plastic elements

Sort the remaining components for disposal, based on their condition. National laws or provisions on waste disposal and protection of the environment apply.

---

### Note

Environmental hazards! Electrical waste and electronic components are subject to treatment as special waste and may only be disposed by approved specialized companies.

---

## 1.8 China RoHS Compliance

Our products manufactured later than June 30, 2016 and those which are sold in the People's Republic of China are marked with one of the following two logos to indicate the Environmental Friendly Use Period in which it can be used safely under normal operating conditions.

Products without below mentioned marking are either manufactured before June 30 or are non-electrical equipment products (EEP).



Circling arrow symbol with "e": The product contains no hazardous substances over the Maximum Concentration Value and it has an indefinite Environmental Friendly Use Period.



Circling arrow symbol with a number: This product contains certain hazardous substances over the Maximum Concentration Value and it can be used safely under normal operating conditions for the number of years indicated in the symbol. The names and contents of hazardous substances can be found in the folder "China RoHS Compliance Certificates" on the documentation CD or DVD enclosed with the product.

## 1.9 Installation awareness

---

### Note

When planning a measurement, observe the following items:

- Consider environmental conditions which might have an influence on the measurement such as temperature, humidity, substances aggressive to the sensor, and pollution.
  - Always use a stiff and vibration-free sensor holder.
  - Define a suitable measuring range, not larger than necessary, in consultation with the operator of the plant.
  - Define the trip limit in consultation with the operator of the plant.
  - Take measurement deviations into account when defining the trip limit.
  - Use a sensor that meets the requirements of the defined measuring range.
  - Ensure an EMC-compatible installation including the use of proper cables.
  - Ensure proper function of the measurement before activating the measurement for regular operation.
-

## 2 Safety instructions

To ensure safe operation, carefully observe all instructions in this manual.

The correct and safe use of this device requires that operating and service personnel both understand and comply with general safety guidelines and observe the special safety comments listed in this manual. Where necessary, safety-sensitive points on the device are marked.

### **⚠ DANGER**

Because the device is electrical equipment, commissioning and service must be performed only by trained and authorized personnel. Maintenance must be carried out only by trained, specialized, and experienced personnel.

---

### 2.1 Using the device

Install and use the device as specified in this document.

If the device is used in a manner not specified by the manufacturer, the functions and protection provided by the device may be impaired.

### 2.2 Owner's responsibility

If there is a reason to suspect that hazard-free operation, and thus, adequate machine protection is no longer possible, take the device out of operation and safeguard it from unintentional operation. This is the case:

- if the device shows visible damage.
- if the device no longer works.
- after any kind of overload that has exceeded the permissible limits (such as those detailed in chapter "Technical data," section "Environmental conditions").

### **⚠ DANGER**

If device tests have to be completed during operation or if the device has to be replaced or decommissioned, it will impair the machine protection and may cause the machine to shut down. Make sure to deactivate machine protection before starting such work, and reactivate it after work has been completed.

---

### 2.3 Radio interference

The device is carefully shielded and tested to be technically immune to radio interference and complies with current standards. However, if you operate this device together with other peripheral devices that are not properly shielded against radio interference, disturbances and radio interferences may occur.

## 2.4 ESD safety

### **⚠ DANGER**

Internal components can be damaged or destroyed due to electrostatic discharge (ESD) during the handling of the device.

Take suitable precautions before handling the device to prevent electrostatic discharges through the sensor electronics. Such measures might include, for example, wearing an ESD bracelet. Transport and storage of electronic components may only be made in ESD-safe packaging.

Handle the device with particular care during dry meteorological conditions with relative humidity below 30% as electrostatic discharges can appear more frequently.

---

## 3 Installing the Piezo CHARM hardware

### 3.1 About the VI Piezo CHARM hardware

The VI Piezo CHARM is a single channel measuring module for the connection of a 2-wire piezoelectric sensor according to the ICP<sup>®</sup> standard. The VI Piezo CHARM converts the analog measuring data provided by the connected sensor into a digital signal. This signal is pre-processed and provided as a peak-to-peak signal to the processor of the system where the CHARM is installed. Parameters for the pre-processing of the measuring data are software configurable. PeakVue is supported by the CHARM. The VI Piezo CHARM can be installed in the AMS Asset Monitor. The standard CHARM Terminal Block KL4502X1-BA1 is required for the installation. See [Figure 3-1](#) for details.

**Figure 3-1: VI Piezo CHARM**

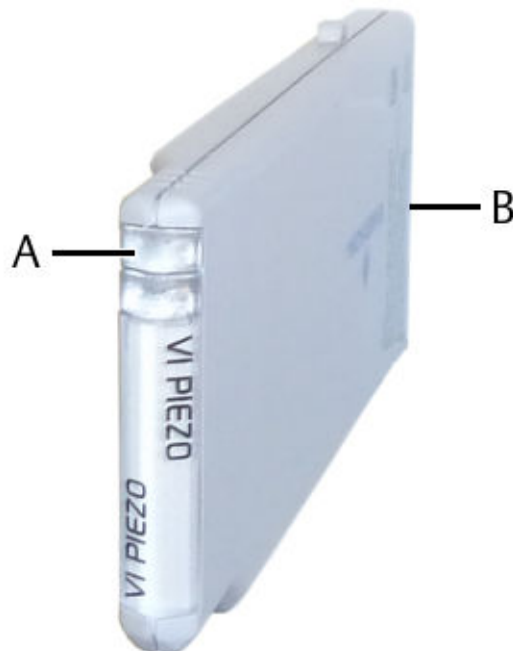

- A. Bicolor LED (red and green), see [Table 5-1](#) for meaning of the indication.
- B. Connector

### 3.2 Install the VI Piezo CHARM

The recommended procedure depends on the system where the VI Piezo CHARM must be installed into. See AMS Asset Monitor manual for the recommended procedure. The described installation procedure is a recommendation and can be changed to the needs of your project.

### ⚠ CAUTION

Any work on the system may impair asset health monitoring and machine protection.

#### Prerequisites

- A prepared slot with an already installed CHARM Terminal Block (KL4502X1-BA1) in a compatible system such as an AMS Asset Monitor
- A suitable flat-tip screwdriver for the terminal screws of the CHARM Terminal Block

#### Procedure

1. Ensure that the latch of the CHARM Terminal Block is in the open position. If the latch is in the closed position, move it outwards to open it.
2. Gently push the VI Piezo CHARM straight into the already installed CHARM Terminal Block. The CHARM latch locks with an audible click in the closed position.

#### Note

The CHARM is hot-swappable. It is not necessary to switch off the power supply of the system before installing or removing the CHARM.

Figure 3-2: CHARM installation

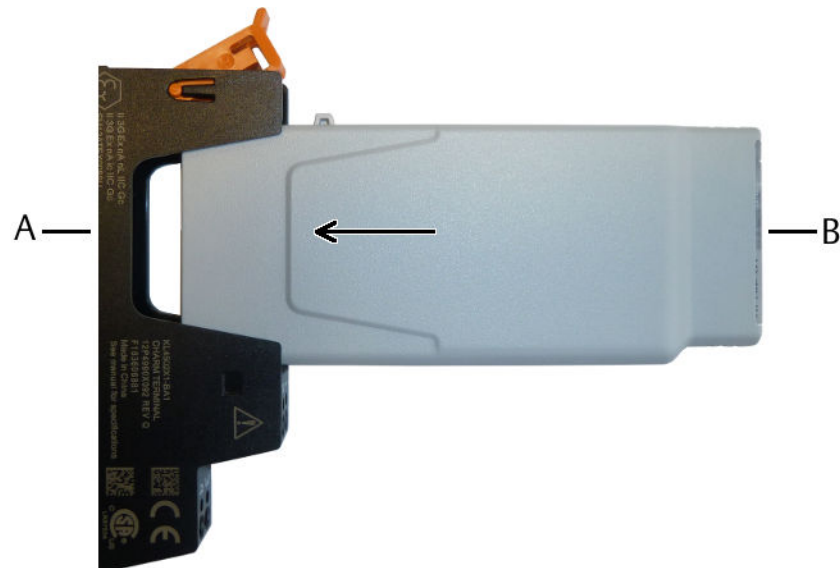

- A. Standard CHARM Terminal Block (KL4502X1-BA1)
- B. VI Piezo CHARM

The CHARM Terminal Block contains keying posts that are automatically set and locked to the unique position of the installed CHARM. The keys prevent the insertion of an incorrect CHARM during maintenance activities.

To reset the keying mechanism, remove the CHARM Terminal Block from the CHARM Baseplate, flip the terminal block 180°, and use your fingers to push the two keying posts completely in so they are sub flush to the bottom face of the terminal

block. Sub flush is the neutral position. You will hear a click when the posts are in the neutral position. When the posts are in the neutral position, the terminal block can receive a different CHARM type.

**⚠ DANGER**

Do not try to install the VI Piezo CHARM into a CHARM Terminal Block with keying posts set for another CHARM type. This might damage Terminal Block and CHARM.

3. Connect a 2-wire piezoelectric sensor to the CHARM Terminal Block.

**Figure 3-3: Sensor connection**

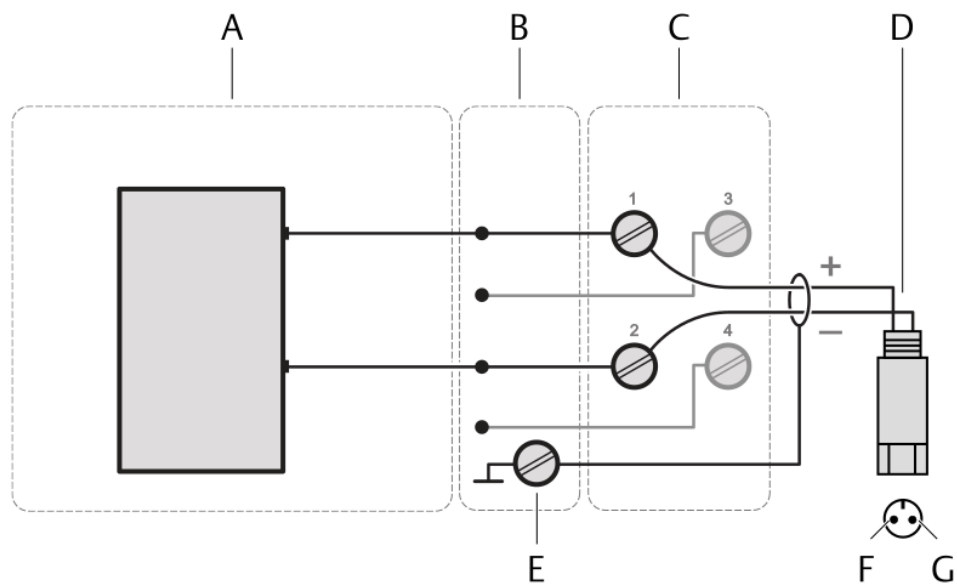

- A. VI Piezo CHARM
- B. CHARM Baseplate
- C. Standard CHARM Terminal Block
- D. 2-wire piezoelectric sensor
- E. Cable shield connection
- F. Top view of the sensor connector – terminal A
- G. Top view of the sensor connector – terminal B

- a) Connect terminal **A** of the 2-wire piezoelectric sensor to terminal **1** of the CHARM Terminal Block.
- b) Connect terminal **B** of the 2-wire piezoelectric sensor to terminal **2** of the CHARM Terminal Block.
- c) Connect the cable shield to a grounding terminal.





## 4 Remove the CHARM

Follow these steps to remove a VI Piezo CHARM from the system.

### ⚠ CAUTION

Any work on the system may impair asset health monitoring and machine protection.

### Note

The CHARM is hot-swappable. It is not necessary to switch off the power supply of the system before installing or removing the CHARM.

### Procedure

1. To remove the CHARM from its Terminal Block, push the latch of the Terminal Block upwards.

**Figure 4-1: Remove the VI Piezo CHARM**

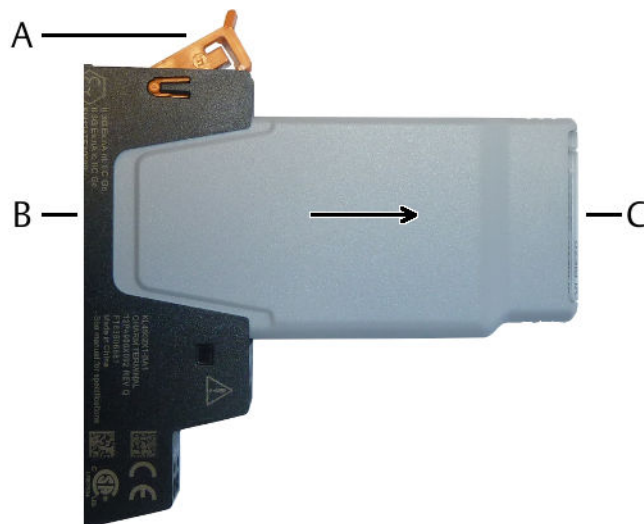

- A. Latch
- B. CHARM Terminal Block
- C. VI Piezo CHARM

The CHARM is unlocked.

2. Pull the VI Piezo CHARM out of the CHARM Terminal Block to remove it completely.



# 5 Maintenance, troubleshooting, and repair

## 5.1 Maintenance

The VI Piezo CHARM does not require any maintenance during normal operation.

## 5.2 Troubleshooting

Follow these first troubleshooting steps in case of an unexpected behavior of the VI Piezo CHARM.

### Procedure

1. Check the firmware version of the VI Piezo CHARM. Does the CHARM have the latest firmware version installed?

Update the firmware of the CHARM if a newer version is available. See AMS Asset Monitor manual for the recommended procedure.

2. Check the bicolored LED at the front of the CHARM.

**Table 5-1: Meaning of the LED indication**

Event	LED indication	
	LED Color	Blinking pattern
CHARM is functioning normally	Green	Solid
CHARM is healthy but configuration is incomplete	Green	Flashing (2 Hz)
During tuning phase (after saving the configuration or after a sensor is connected)		
CHARM has a communication fault	Red	Solid
Signal wiring fault, but CHARM passed all self tests	Red	Flashing (2 Hz)
CHARM failed to get address assignment	Red	Flashing (5 Hz)
Non-fatal fault detected	Green/Red	Alternating (5 Hz)
During recognition by the AMS Asset Monitor	Green/Red	Alternating for 2 to 3 seconds
Until CHARM is configured	Green	Flashing (3 Hz)
CHARM is not calibrated	Red	Flashing

3. Start with the solutions provided by the table below to solve the issue.

**Table 5-2: Proposed solutions**

Event	Proposed solutions
CHARM is healthy but configuration is incomplete	Complete the commissioning of the VI Piezo CHARM. See operating manual of the system where the CHARM is installed.
CHARM has a communication fault	<ul style="list-style-type: none"> <li>a. Check the system where the CHARM is installed for configuration issues.</li> <li>b. Check the hardware. Are there any contact problems between the baseplate and the CHARM Terminal block or between the CHARM Terminal Block and the CHARM?</li> <li>c. Replace the CHARM and the CHARM Terminal Block to exclude hardware faults.</li> <li>d. In case of an hardware fault replace the defective component.</li> </ul>
Signal wiring fault, but CHARM passed all self tests	<ul style="list-style-type: none"> <li>a. Check the sensor wiring for cable break, loosened contacts, and wiring faults.</li> <li>b. Measure the sensor signal. Does the sensor signal meet the limits of <a href="#">Figure 5-1</a>?</li> </ul>
CHARM failed to get address assignment	<ul style="list-style-type: none"> <li>a. Check the system where the CHARM is installed for configuration issues.</li> <li>b. Check the hardware. Are there any contact problems between the baseplate and the CHARM Terminal block or between the CHARM Terminal Block and the CHARM?</li> <li>c. Check the Address Plug of the system where the CHARM is installed.</li> <li>d. Replace the CHARM, the CHARM Terminal Block, the Address Plug, and the CHARM Address Terminal Block to exclude hardware faults.</li> <li>e. In case of an hardware fault replace the defective component.</li> </ul>
CHARM is not calibrated	Replace the CHARM.
Non-fatal fault detected	Check the online display of the system where the CHARM is installed to get further information on this event message.

Figure 5-1: Signal OK limits

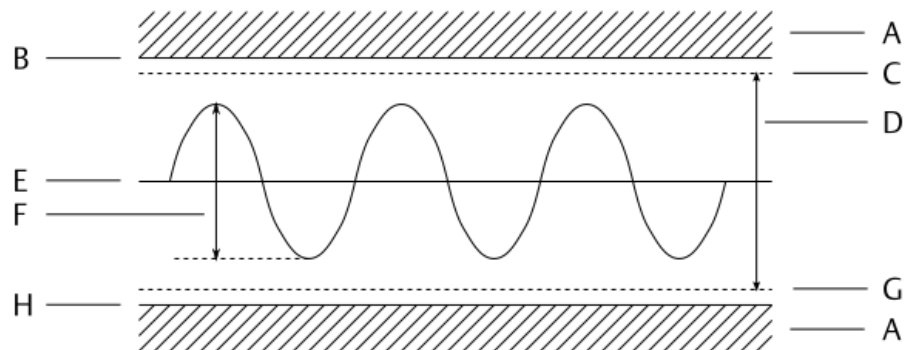

- A. Signal not OK area
- B. Upper signal not OK limit: 28.0 V
- C. Upper limit of the permissible voltage range: 28.0V
- D. Permissible voltage range
- E. Bias voltage (sensor dependent, typical 8.0 to 14.0 V DC)
- F. Maximum signal: 28.0 V peak-to-peak
- G. Lower limit of the permissible voltage range: 0.0V
- H. Lower signal not OK limit: -1.5 V

4. Continue troubleshooting with the assistance of the technical support if the CHARM is still not working as expected.

## 5.3 Repair

Repair of a defective VI Piezo CHARM is not possible. In case of defects, the VI Piezo CHARM must be replaced.

## 5.4 Replace a VI Piezo CHARM

It is not possible to repair a VI Piezo CHARM. In case of defects, the CHARM must be replaced. Follow the steps listed below if a CHARM needs to be replaced.

### ⚠ CAUTION

Any work on the system may impair asset health monitoring and machine protection.

#### Note

The CHARM is hot-swappable. It is not necessary to switch off the power supply of the system before installing or removing the CHARM.

The configuration of the CHARM is stored in the system. So it is not necessary to create a backup of the configuration before replacing the CHARM.

#### Procedure

1. Remove the CHARM from the CHARM Terminal Block. See [Remove the CHARM](#).

2. Install the new CHARM. See [Install the VI Piezo CHARM](#).  
The CHARM is automatically detected by the system.
3. Ensure that the CHARM has been correctly detected by the system and is working fault free.  
Check the status LED on the front of the CHARM and the status indications of the system's software.

## 6 Technical data

Only specifications with indicated tolerances or limit values are obligatory. Data without tolerances or without error limits are informative data and not guaranteed. Technology is under constant development and specifications are subject to change without notice. If not otherwise specified, all data refer to a nominal supply voltage of 24 V DC and an environmental temperature of +23°C.

### 6.1 Electrical data

#### Supply

Sensor supply current	1 to 8 mA	±5%, ±75µA
Sensor supply excitation voltage	>20 V	
CHARM power requirements	25 mA at 24 V DC	
CHARM power dissipation	0.6 W	

#### Signal input

Sensor types	2-wire ICP®	
Nominal signal range	0 to +28 V	
Full signal range	-1.5 V to +28 V	
Input frequency range	0 to 40 kHz	Attenuation <3 dB
Dynamic range	>99 dB	
Input impedance	>100 kΩ	
Resolution	24 Bit A/D Converter	

#### Accuracy

Basic accuracy	±0.8%, ±5.0 mV	
Accuracy over temperature	±0.5%, ±5.0 mV	

### 6.2 Environmental conditions and mechanical design

#### Environmental conditions

Operating temperature	-40 to +70°C	
Storage temperature	-40 to +85°C	
Humidity	5 to 95%	Noncondensing
IP protection class	IP20	According to IEC 60529

Shock	150 m/s <sup>2</sup>	According to IEC 60068-2-27, 4000 shocks per axis
Vibration	0.15 mm	10 to 58.1 Hz
	20 m/s <sup>2</sup>	58.1 to 150 Hz
		According to IEC 60068-2-6, floating sinus, 20 cycles, three axes
Operating altitude	<2000 m	Above sea level

### Mechanical design

Status indication	LED	One red/green bicolored LED
Weight	Approximately 35 g	Without packaging
Dimensions	See <a href="#">Figure 6-1</a>	

**Figure 6-1: Dimension**

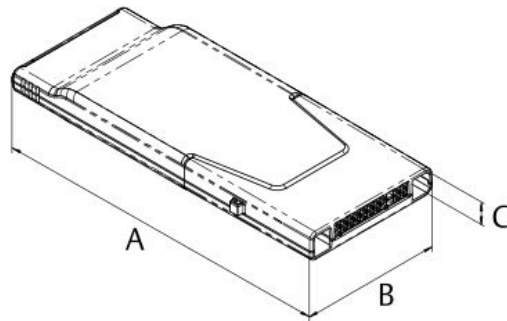

- A. 116 mm
- B. 47 mm
- C. 11 mm



# 7 Certificates



## EU-Declaration of Conformity (Translation)

We: epro GmbH, Jöbkesweg 3, 48599 Gronau  
declare under our sole responsibility that following product(s):

Product designation:	AMS Asset Monitor	
Product description:	Online Prediction, Protection and Process Monitor	
Part numbers	AM5820-IM	AMS Asset Monitor Base - Imperial Threaded Unit
	AM5730	AMS Asset Monitor – +24V SC Power Module
	AM5125	VI Piezo CHARM
	AM5620	VI Voltage CHARM
	AM5312	VI Tach CHARM
	KL4502X1-BA1	Standard Terminal Block

are in conformity with the terms of the directives mentioned below including any amendment valid at the date of declaration:

2014/30/EU	Electromagnetic compatibility
2014/34/EU	Equipment and protective system intended for use in potentially explosive atmospheres
2011/65/EU	The restriction of the use of certain hazardous substances in electrical and electronic equipment

**Following harmonized standards have been applied:**

2014/30/EU	EN 61326-1	Electrical equipment for measurement, control and laboratory use. EMC requirements.
2014/34/EU	EN 60079-0	Part 1: General requirements Explosive atmospheres - Part 0: Equipment- General requirements
	EN 60079-7	Explosive atmospheres - Part 7: Equipment protection by increased safety "e"
	EN 60079-11	Explosive atmospheres- Part 11: Intrinsic Safety „i“
	EN 60079-15	Explosive atmospheres- Part 15: Equipment protection by type of protection "n"
	EN 60079-31	Explosive atmospheres- Part 31: Equipment dust ignition protection by enclosure "t"
2011/65/EU	EN IEC 63000	Technical documentation for the assessment of electrical and electronic products with respect to the restriction of hazardous substances

For the type examination according to EN 60079-0, EN 60079-7, EN 60079-11, EN 60079-15 and EN 60079-31 the following notified body has been involved;

DEKRA EXAM GmbH  
Type examination certificate BVS 20 ATEX E 001 X

Authorized person for technical documentation:  
Bruno Hecker, Jöbkesweg 3, 48599 Gronau

Gronau, 17 May 2022  
Place, Date

  
Managing Director

  
Quality



### UKCA-Declaration of Conformity

We, the manufacturer: epro GmbH, Jöbkesweg 3, 48599 Gronau, Germany  
declare under our sole responsibility that following product(s):

Product designation:	AMS Asset Monitor	
Product description:	Online Prediction, Protection and Process Monitor	
Part numbers	AM5820-IM	AMS Asset Monitor Base - Imperial Threaded Unit
	AM5730	AMS Asset Monitor – +24V SC Power Module
	AM5125	VI Piezo CHARM
	AM5620	VI Voltage CHARM
	AM5312	VI Tach CHARM
	KL4502X1-BA1	Standard Terminal Block

are in conformity with the terms of the directives mentioned below including any amendment valid at the date of declaration:

- S.I. 2016 No. 1091 Electromagnetic Compatibility Regulations 2016
- S.I. 2016 No. 1107 Equipment and Protective Systems Intended for use in Potentially Explosive Atmospheres Regulations 2016
- S.I. 2016 No. 3032 The restriction of the use of certain hazardous substances in electrical and electronic equipment

**Following standards have been applied:**

- S.I. 2016 No. 1091 EN 61326-1 Electrical equipment for measurement, control and laboratory use. EMC requirements. Part 1. General requirements
- S.I. 2016 No. 1107 EN 60079-0 Explosive atmospheres -Part 0: Equipment- General requirements
- EN 60079-7 Explosive atmospheres - Part 7: Equipment protection by increased safety "e"
- EN 60079-11 Explosive atmospheres- Part 11: Intrinsic Safety „i“
- EN 60079-15 Explosive atmospheres- Part 15: Equipment protection by type of protection "n"
- EN 60079-31 Explosive atmospheres- Part 31: Equipment dust ignition protection by enclosure "t"
- S.I. 2016 No. 3032 EN IEC 63000 Technical documentation for the assessment of electrical and electronic products with respect to the restriction of hazardous substances

**For the type examination according to EN 60079-0, EN 60079-7, EN 60079-11, EN 60079-15 and EN 60079-31 the following notified body has been involved:**

DEKRA Testing and Certification GmbH  
Type examination certificate BVS 20 ATEX E 001 X

**Authorized person for technical documentation:**

Bruno Hecker, Jöbkesweg 3, 48599 Gronau, Germany

**Authorized Representative:**

Emerson Process Management Limited,  
company No 00671801  
Meridian East,  
Leicester  
LE19 1UX, United Kingdom  
Regulatory Compliance Department  
email: [ukproductcompliance@emerson.com](mailto:ukproductcompliance@emerson.com)  
Phone: +44 11 6282 23 64

M. Fränzer  
Managing Director

B. Hecker  
Quality

Place, Date: Gronau, 13 September 2022



**Emerson**

12001 Technology Drive  
Eden Prairie, MN 55344 USA  
T 1(952)828-3000  
[www.Emerson.com](http://www.Emerson.com)

**Emerson**

835 Innovation Drive  
Knoxville, TN 37932 USA  
T +1 865-675-2400  
F +1 865-218-1401  
[www.Emerson.com](http://www.Emerson.com)

**Emerson**

Jöbkesweg 3  
48599 Gronau  
Germany  
T +49 2562 709 0  
F +49 2562 709 401  
[www.Emerson.com/ams](http://www.Emerson.com/ams)

©2022, Emerson. All rights reserved.

The contents of this publication are presented for informational purposes only, and while diligent efforts were made to ensure their accuracy, they are not to be construed as warranties or guarantees, express or implied, regarding the products or services described herein or their use or applicability. All sales are governed by our terms and conditions, which are available on request. We reserve the right to modify or improve the designs or specifications of our products at any time without notice.

The Emerson logo is a trademark and service mark of Emerson Electric Co. The AMS logo is a mark of one of the Emerson family of companies. All other marks are the property of their respective owners.

