

<b>ASCA</b> numatics	INSTALLATION AND MAINTENANCE INSTRUCTIONS	GB
	INSTRUCTIONS D'INSTALLATION ET DE MAINTENANCE	FR
	INBETRIEBNAHME - UND WARTUNGSANLEITUNG	DE
	INSTRUCCIONES DE PUESTA EN MARCHA Y MANTENIMIENTO	ES
	ISTRUZIONI DI MESSA IN SERVIZIO E MANUTENZIONE	IT
	ALGEMENE INSTALLATIE- EN ONDERHOUDSINSTRUCTIES	NL
	INSTALLASJONS- OG VEDLIKEHOLDSINSTRUKSER	NO
	INSTALLATIONS- OCH UNDERHÅLLSINSTRUKTIONER	SE
	ASENNUS - JA HUOLTO-OHJEET	FI
	INSTALLATIONS - OG VEDLIGEHOIDSANVISNINGER	DK
	INSTRUÇÕES DE INSTALAÇÃO E MANUTENÇÃO	PT
	ΟΔΗΓΙΕΣ ΤΟΠΟΘΕΤΗΣΗΣ ΚΑΙ ΣΥΝΤΗΡΗΣΗΣ	GR
	POKRYNY PRO INSTALACI A ÚDRŽBU	CZ
INSTRUKCJA MONTAŻU I KONSERWACJI	PL	
TELEPÍTÉSI ÉS KARBANTARTÁSI ÚTMUTATÓ	HU	
Инструкция по установке и обслуживанию	RU	

### ISO 15552 cylinders

# 453



# 454



# 450



522807-001 / B  
Availability, design and specifications are subject to change without notice. All rights reserved.



### Temperatures

453  
454  
450

STORAGE CONDITIONS



(-40°C)



≤ +70°C  
(+120°C = "HTP")



humidity relative  
≤ 95%



OPERATING CONDITIONS

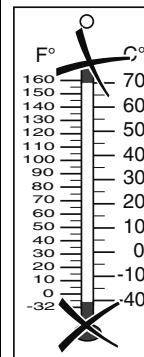

+70°C  
(+120°C = «HTP»)



-20°C

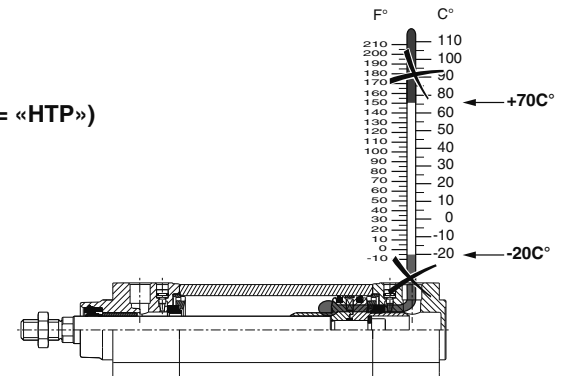

## Characteristics

453  
454  
450

### OPERATING PRESSURE

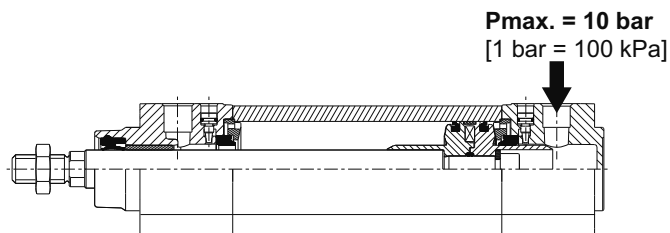

ISO 8573-1 (2010) ]: Level 7.4.4



AIR  
NEUTRAL GASES

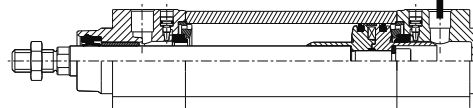
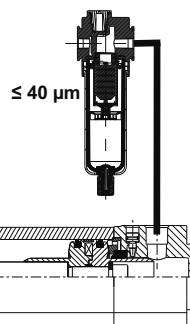

### AIR QUALITY

### LIFE CYCLE

LFS  
453  
450  
~~454~~



max. 3 m/s

Long Life

$\leq 1 \text{ m/s}$  (max. 2 m/s)

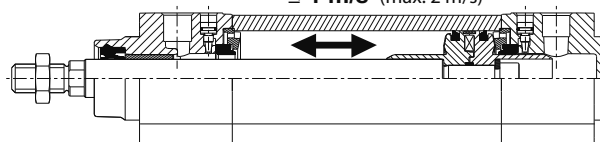

### LUBRICATING OIL

Non-detergent oil without aggressive additives

VG 32 class (ISO 3448)

Viscosity 29 to 35 cSt ( $\text{mm}^2/\text{s}$ ) at 40°C

Silicone-base lubricants



## Characteristics

453  
454  
450

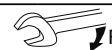

Ø (mm)	N.m	Inch.pounds
32 - 40	7	31,74
50 - 63	13,5	119,07
80 - 100	27,5	242,55
125	60	529,2
160 - 200	100	882
250 - 320	300	2646

### MOUNTINGS

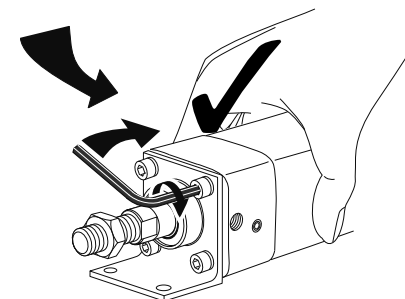

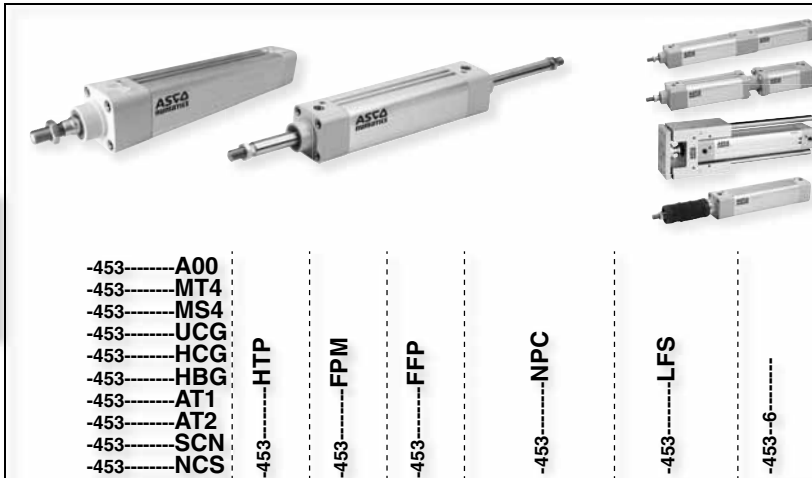

- 453-----A00
  - 453-----MT4
  - 453-----MS4
  - 453-----UCG
  - 453-----HCG
  - 453-----HBG
  - 453-----AT1
  - 453-----AT2
  - 453-----SCN
  - 453-----NCS
- |  |              |              |              |              |              |            |
|--|--------------|--------------|--------------|--------------|--------------|------------|
|  | -453-----HTP | -453-----FPM | -453-----FFP | -453-----NPC | -453-----LFS | -453-----6 |
|--|--------------|--------------|--------------|--------------|--------------|------------|

Ø (mm)									
32	97802343	97802736	.... <sup>(2)</sup>	97802229	97802238	97802247	M454A3RA0000A00	97802060	-
40	97802344	97802737	.... <sup>(2)</sup>	97802230	97802239	97802248	M454A4RA0000A00	97802061	-
50	97802345	97802738	.... <sup>(2)</sup>	97802231	97802240	97802249	M454A5RA0000A00	97802062	-
63	97802346	97802739	.... <sup>(2)</sup>	97802232	97802241	97802249	M454A5RA0000A00	97802887	.... <sup>(2)</sup> 97802333
80	97802347	97802740	.... <sup>(2)</sup>	97802233	97802242	97802250	M454A8RA0000A00	97802888	.... <sup>(2)</sup> 97802334
100	97802259	97802741	.... <sup>(2)</sup>	97802234	97802243	97802250	M454A8RA0000A00	-	97802335

*grease h* (11 cm³) = 97802100

ROD  
+  
PISTON UNIT <sup>(2)</sup> Specify stroke length (in mm).

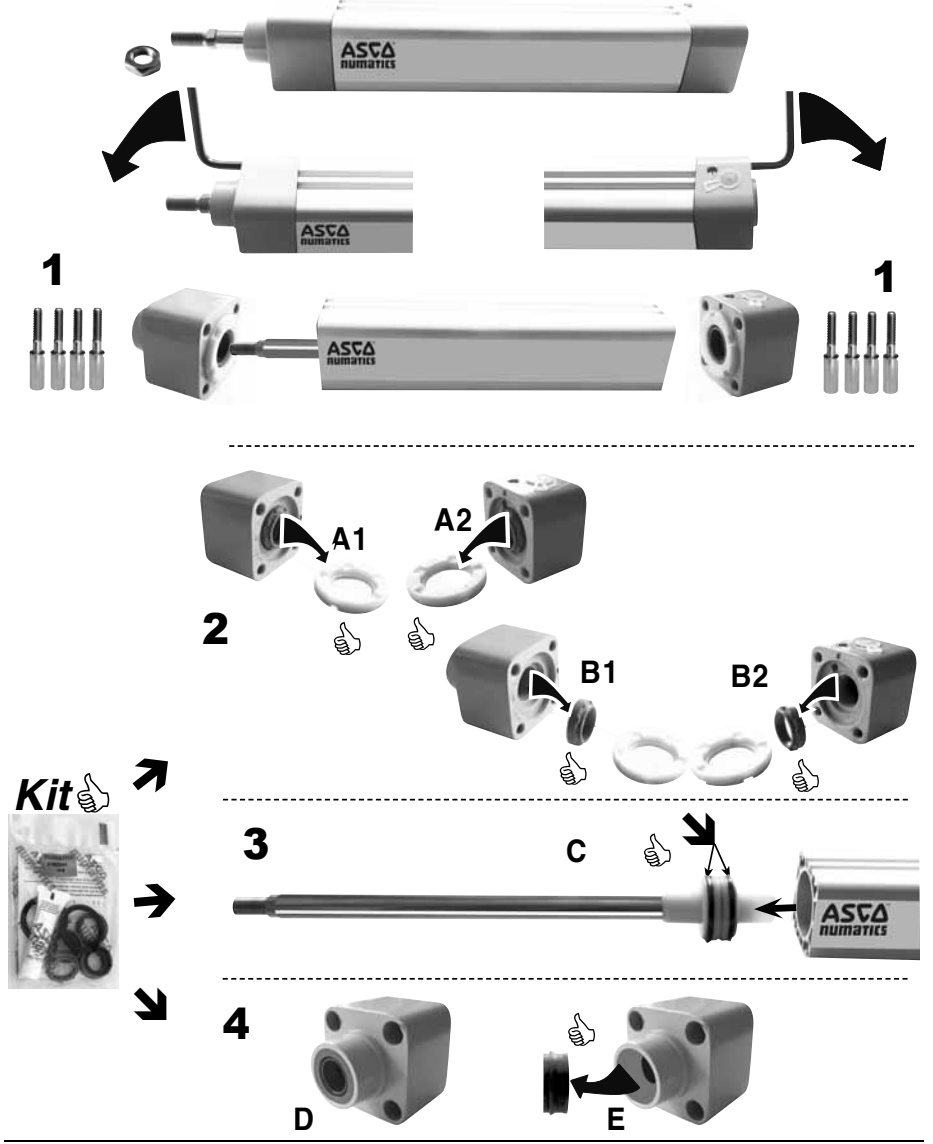
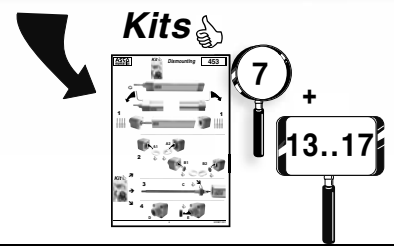



454



-454-----A00/SCN/AT1/AT2/LSR/LSS

15-DIGIT PRODUCT CODE

M 454 A    -    -    - 0000 A00  
 Ø (mm) 3 = 32 4 = 40 5 = 50 6 = 63 8 = 80 1 = 100  
 S R S P S R A A F F P P  
 Kits

grease (11 cm³) = 97802100



32-40	P4994395723N001
50-63	P4994395735N001
80-100	P4994395748N001

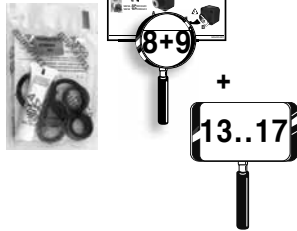

Kits

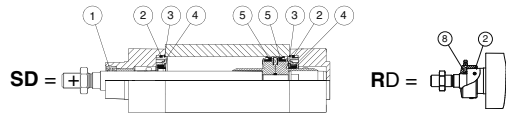

Ø (mm)	
80	P4995026728N001
100	P4995025441N001
125 (Series 450)	P499502668PN001
160 (Series 450)	P499516338QN001
200 (Series 450)	P499516339RN001



Dismounting

454



Kits

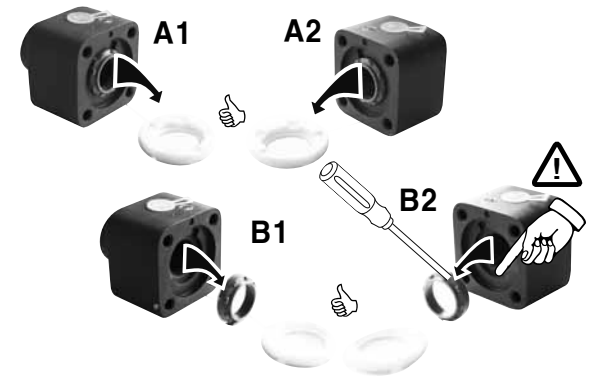

C

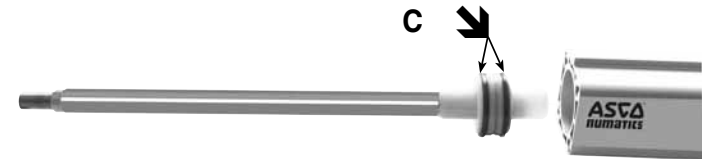

**Kits**



M454--SA0000A00  
M454--RA0000A00



**D1**

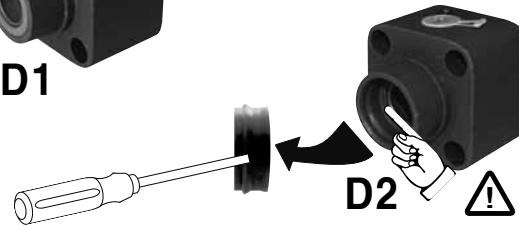

**Kits**



M454--SF0000A00  
M454--RF0000A00



**A**

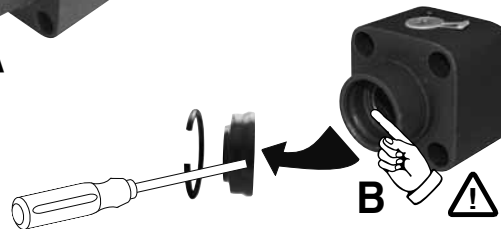

**Kits**



M454--SP0000A00  
M454--RP0000A00



**A**

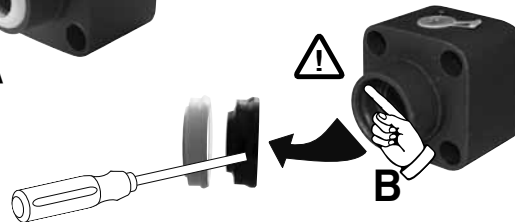

**Kit**



**450**



- 450-----A00
- 450-----FMT
- 450-----FST
- 450-----UCG
- 450-----HCG
- 450-----HBG
- 450-----AT1
- 450-----AT2
- 450-----NCS
- 450-----TAN

-450-----HTP

-450-----FPM

-450-----FFP

-450-----NPC

-450-----LFS

-450-----6

Ø (mm)	1 + 2 + 3 + 4 +						↓	↓	↓	
	1	2	3	4	3	2				
32	97802343	97802736	...	(2)	97802229	97802238	97802247	M454A3RA0000A00	97802060	-
40	97802344	97802737	...	(2)	97802230	97802239	97802248	M454A4RA0000A00	97802061	-
50	97802345	97802738	...	(2)	97802231	97802240	97802249	M454A5RA0000A00	97802062	-
63	97802346	97802739	...	(2)	97802232	97802241	97802249	M454A5RA0000A00	97802887	97802333
80	97802347	97802740	...	(2)	97802233	97802242	97802250	M454A8RA0000A00	97802888	97802334
100	97802259	97802741	...	(2)	97802234	97802243	97802250	M454A8RA0000A00	-	97802335
125	97802260	97802742	...	(2)	97802235	97802244	97802251	M400APRA0000A00	-	97802336
160	97802261	97802743	...	(2)	97802236	97802245	97802252	M400AQRA0000A00	-	-
200	97802262	97802744	...	(2)	97802237	97802246	97802252	M400AQRA0000A00	-	-

(11 cm³) = **97802100**

ROD  
+  
PISTON  
UNIT (2) Specify stroke length (in mm).

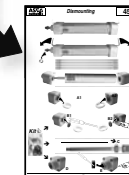

**12..17**



# Dismounting

450

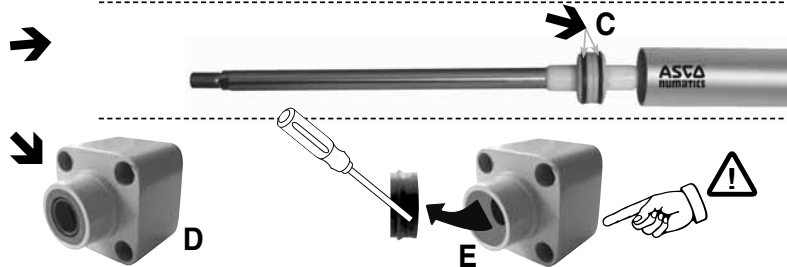
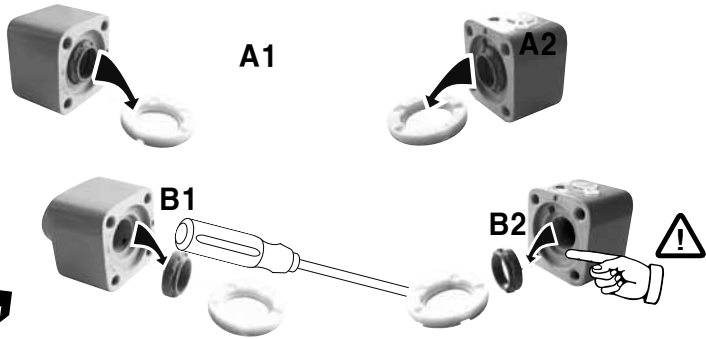

# Reassembly

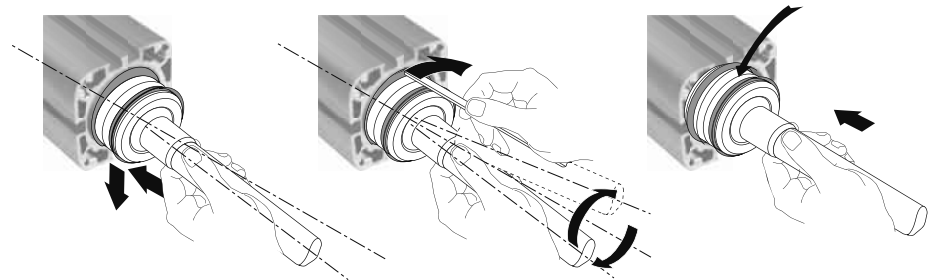
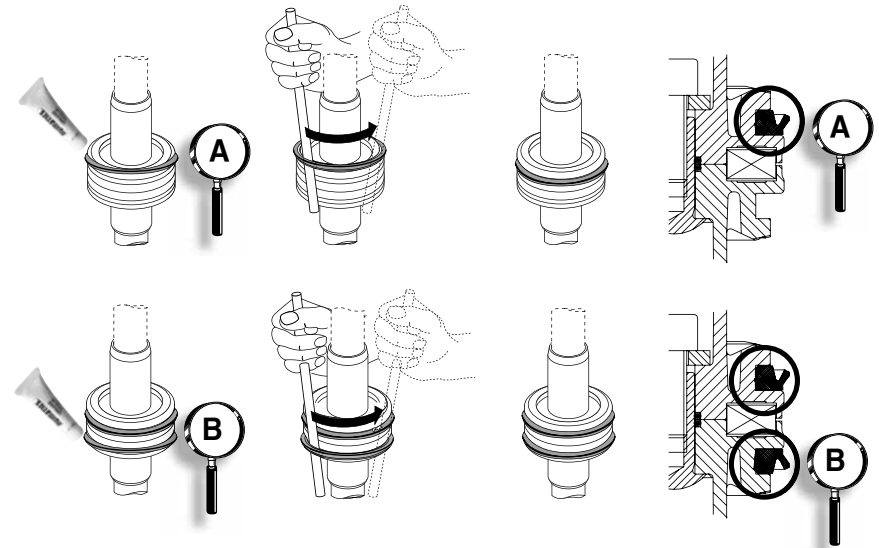

453-454-450

I

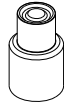
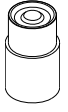
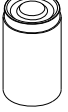

**Reassembly 453-454-450**

LFS (453-450) + 454

<b>Kit</b> 	<b>mounting tools</b>					 <b>II</b>
	<b>Scraper</b>	Ø32	Ø40	Ø50 Ø63	Ø80 Ø100	

**453 + 450**

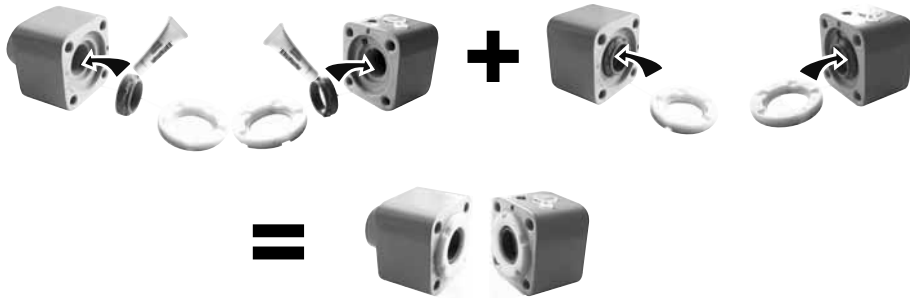

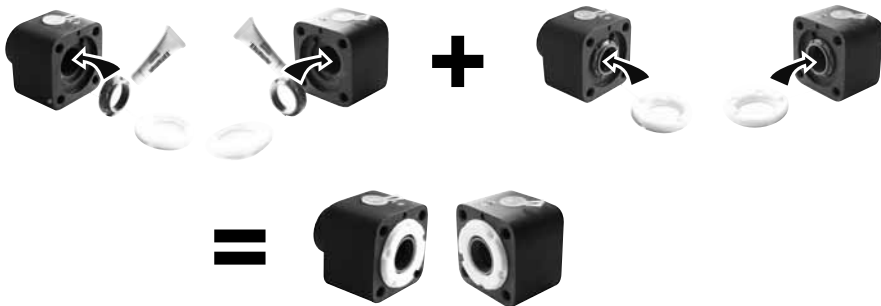

**454**

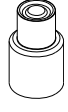
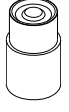
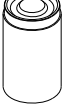

**Reassembly 453-454-450**

LFS (453-450) + 454

<b>Kit</b> 	<b>mounting tools</b>					 <b>II</b>
	<b>Scraper</b>	Ø32	Ø40	Ø50 Ø63	Ø80 Ø100	

**453 + 450**



**454**

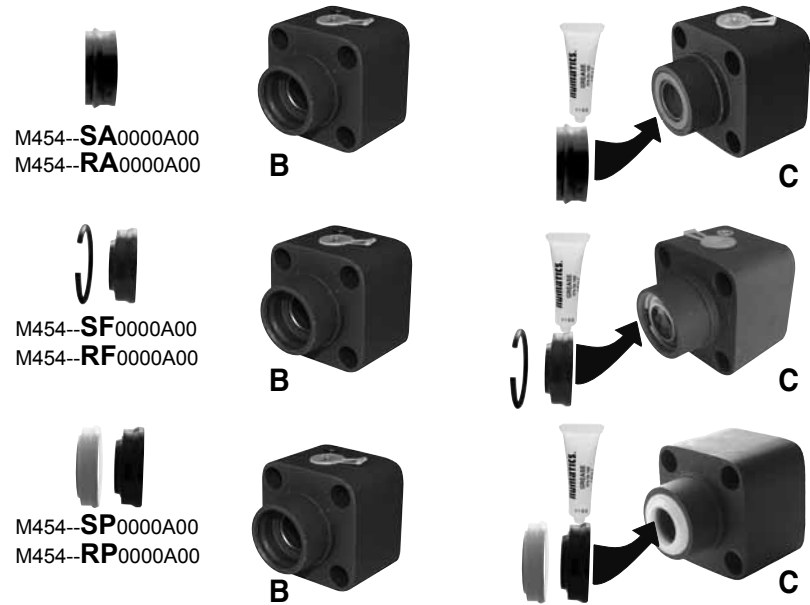



**Reassembly 453-454-450**

**IV**

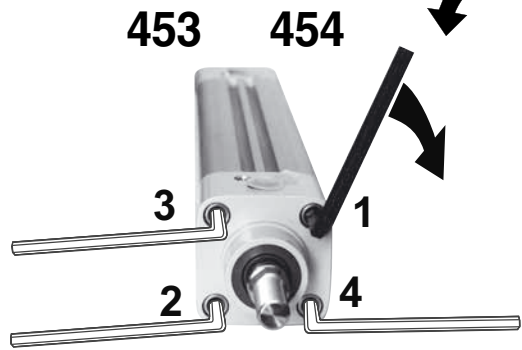

**453 - 454**

Ø (mm)	N.m	Inch.pounds
32 - 40	7	31,74
50 - 63	13,5	119,07
80 - 100	27,5	242,55

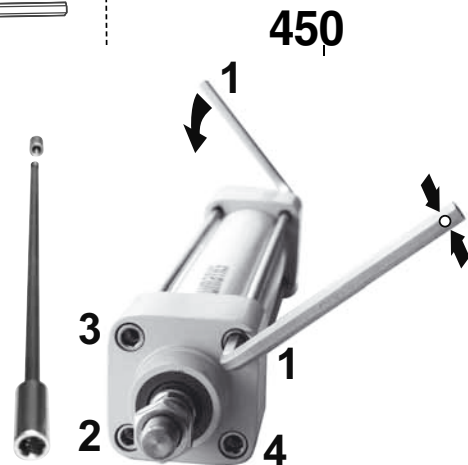

**450**

Ø (mm)	N.m	Inch.pounds	epoxy	
			N.m	Inch.pounds
32	7	31.74	1,5	13.23
40	7	31.74	3	26.46
50	13,5	119.07	4	35.28
63	13,5	119.07	5	44.1
80	27,5	242.55	8	70.56
100	27,5	242.55		
125	60	529.2		
160 - 200	100	882		

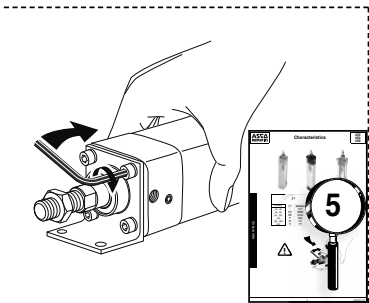

**Reassembly 453-454-450**

**V**







