

| | | |
|---|---|----|
| ASCO™ | INSTALLATION AND MAINTENANCE INSTRUCTIONS | EN |
| | INSTRUCTIONS D'INSTALLATION ET DE MAINTENANCE | FR |
| | INBETRIEBNAHME - UND WARTUNGSANLEITUNG | DE |
| | INSTRUCCIONES DE PUESTA EN MARCHA Y MANTENIMIENTO | ES |
| | ISTRUZIONI DI MESSA IN SERVIZIO E MANUTENZIONE | IT |
| | ALGEMENE INSTALLATIE- EN ONDERHOUDSINSTRUCTIES | NL |
| | INSTALLASJONS- OG VEDLIKEHOLDSINSTRUKSER | NO |
| | INSTALLATIONS- OCH UNDERHÅLLSINSTRUKTIONER | SE |
| | ASENNUS - JA HUOLTO-OHJEET | FI |
| | INSTALLATIONS - OG VEDLIGEHOLDSANVISNINGER | DK |
| | INSTRUÇÕES DE INSTALAÇÃO E MANUTENÇÃO | PT |
| | ΟΔΗΓΙΕΣ ΤΟΠΟΘΕΤΗΣΗΣ ΚΑΙ ΣΥΝΤΗΡΗΣΗΣ | GR |
| | POKYNY PRO INSTALACI A ÚDRŽBU | CZ |
| | INSTRUKCJA MONTAŻU I KONSERWACJI | PL |
| | TELEPÍTÉSI ÉS KARBANTARTÁSI ÚTMUTATÓ | HU |
| | Инструкция по установке и обслуживанию | RU |
| МОНТАЖДАУ ЖӘНЕ ҚЫЗМЕТ КӨРСЕТУ НҰСҚАУЛАР | KZ | |
| 설치 및유지 관리 지침 | KR | |

290

proportional motorised valve



NBR / PBT «K»

24 V DC ≡

E290CP-V0K4MAV1

E290CP-V0K00VV1



FPM / 316L «X»

24 V DC ≡

E290CP-V0X4MAV1

E290CP-V0X00VV1

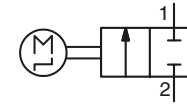

NBR / PBT «K» - FPM / 316L «X»

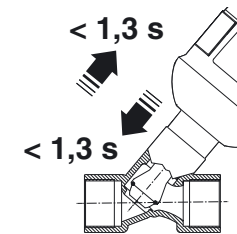

ACTUATING TIME

FLOW

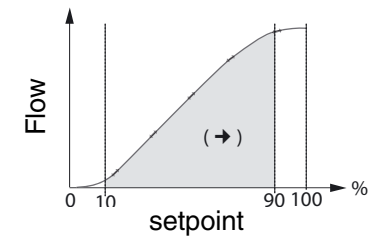

(→) Recommended working area

- Linearity ±5%
- hysteresis < 5%
- accuracy < 3%
- sensitivity < 3%
- repeatability < 3%

514362-001 / A
Availability, design and specifications are subject to change without notice. All rights reserved.

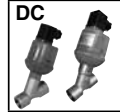
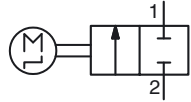

NBR / PBT «K»

| PMA (Max. allowable pressure) 10 bar max. | | | | | |
|--|---------------------------------------|-----|-------|-----|--|
| flow coefficient Kv | operating pressure differential (bar) | | min. | | |
| | max. | air | water | oil | |
| (m ³ /h) | (l/min) | | | | |
| NBR / PBT «K» | | | | | |
| 3/8 | 2,7 | 45 | 0 | 6 | |
| 1/2 | 3,8 | 63 | 0 | 5 | |
| 3/4 | 6 | 100 | 0 | 4 | |

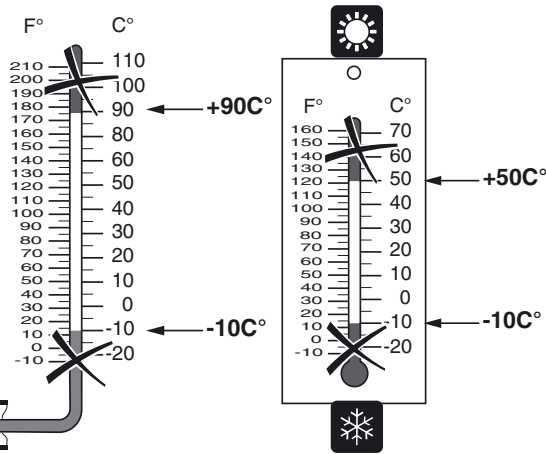

RECOMMENDATION FOR MAXIMUM DUTY CYCLE

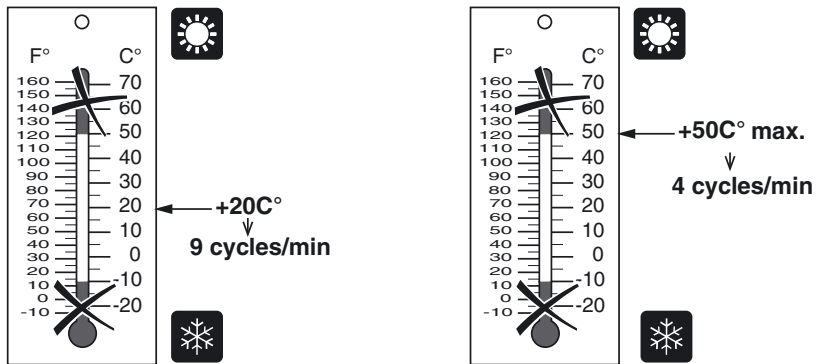

OPERATING CONDITIONS

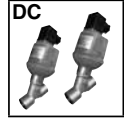
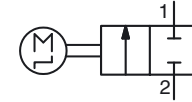

FPM / 316L «X»

| PMA (Max. allowable pressure) 10 bar max. | | | | | |
|--|---------------------------------------|-----|-------|-----|-------|
| flow coefficient Kv | operating pressure differential (bar) | | min. | | |
| | max. | air | water | oil | steam |
| (m ³ /h) | (l/min) | | | | |
| FPM / 316L «X» | | | | | |
| 3/8 | 2,7 | 45 | 0 | 6 | 4 |
| 1/2 | 3,8 | 63 | 0 | 5 | 4 |
| 3/4 | 6 | 100 | 0 | 4 | 4 |

RECOMMENDATION FOR MAXIMUM DUTY CYCLE

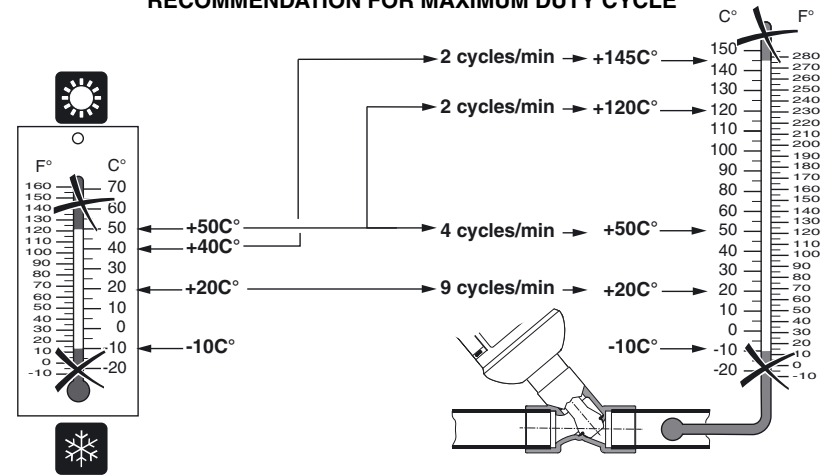

OPERATING CONDITIONS

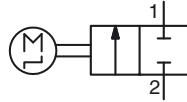

24 V ±10 % DC
(NBR / PBT «K» / FPM / 316L «X»)



MOUNTING «K» + «X»

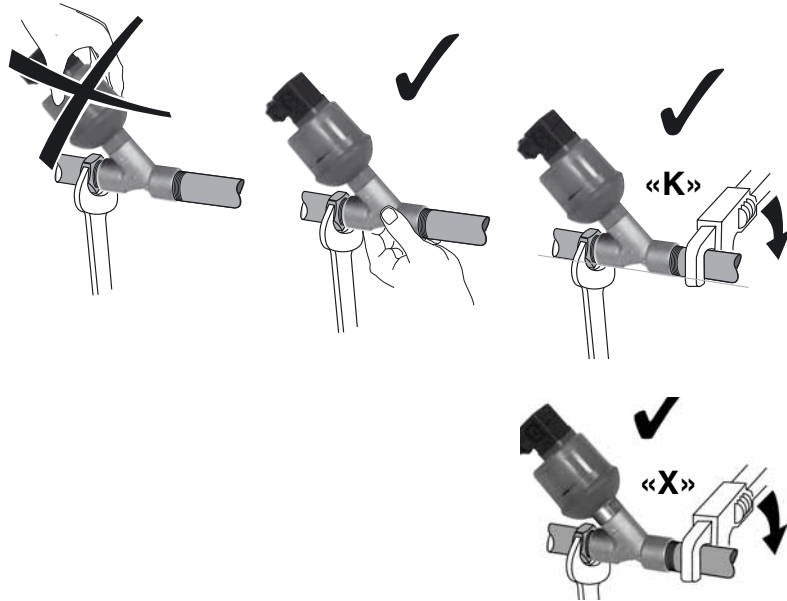

| | |
|---|-------------------------------|
| 1 | 24 V / DC |
| 2 | 0 V |
| 3 | setpoint (0-10 V or 4-20 mA) |
| 4 | feedback signal [24 V switch] |

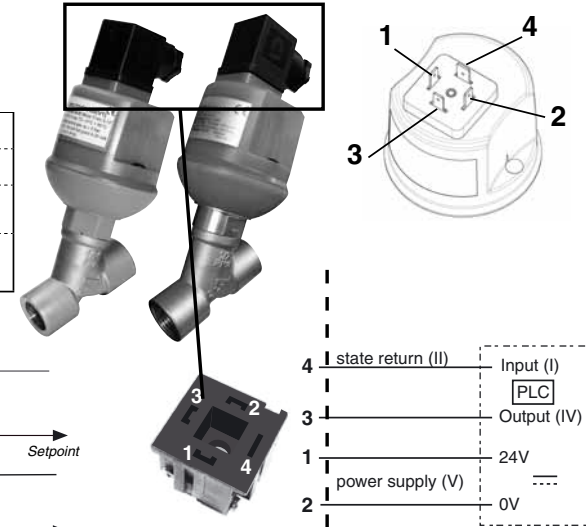
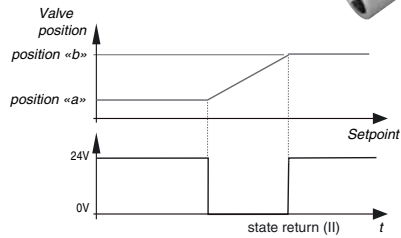

| | FR | DE | ES | IT |
|------|-------------------------|----------------------|------------------------|-------------------------|
| (I) | entrée | Eingang | entrada | input |
| (II) | signal de retour | Stellungsrückmeldung | Retorno de estado | ritorno |
| (IV) | sortie | Ausgang | salida | output |
| (V) | alimentation électrique | Spannungsversorgung | Alimentación eléctrica | Alimentazione elettrica |

| | NL | PT | RU | KZ |
|------|----------------------|----------------------|-------------------|---------------|
| (I) | input | entrada | вход | кіріс |
| (II) | terugkeer naar stand | retorno de estado | возврат состояния | күйді қайтару |
| (IV) | output | saída | выход | шығыс |
| (V) | voeding | alimentação elétrica | источник питания | қуат көзі |



24 V ±10 % DC
(NBR / PBT «K» / FPM / 316L «X»)

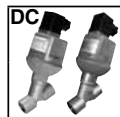

Motor 12 W in operation, < 2 W hold
 Max. pic current: 0,7 A
 Ripple 5%

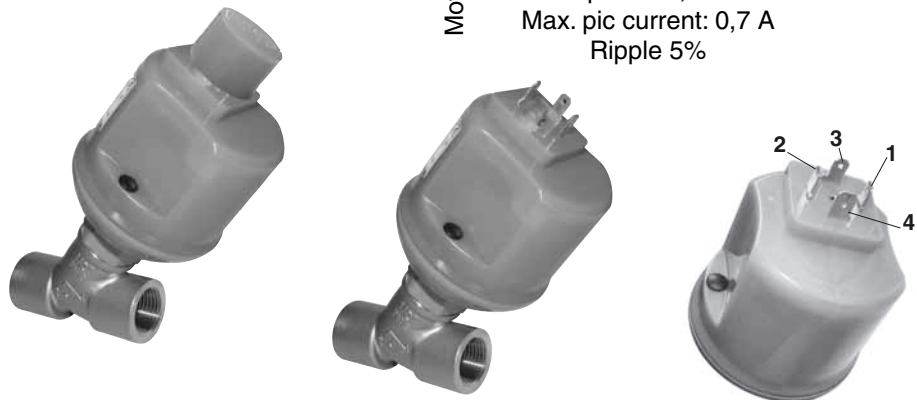

(ISO 4400 / EN 175301-803, form A)

| | |
|---|-------------------------------|
| 1 | 24 V / DC |
| 2 | 0 V |
| 3 | setpoint (0-10 V or 4-20 mA) |
| 4 | feedback signal [24 V switch] |

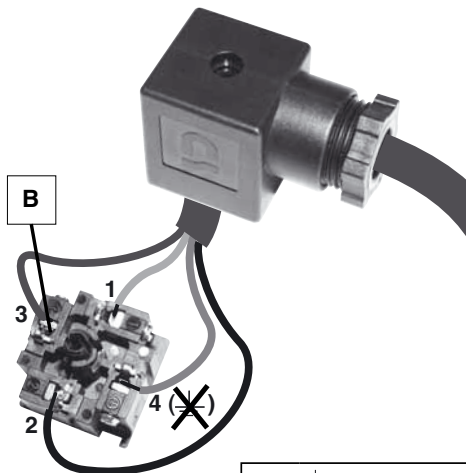
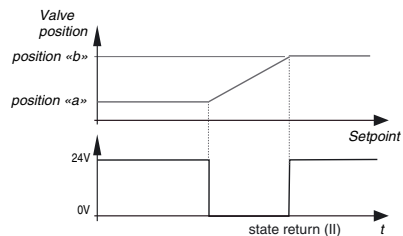

| items | N.m | Inch.pounds |
|----------|-----------|-------------|
| B | 0,4 ±0,05 | 3,2 ±0,4 |



24 V ±10 % DC
(NBR / PBT «K» / FPM / 316L «X»)



IP65

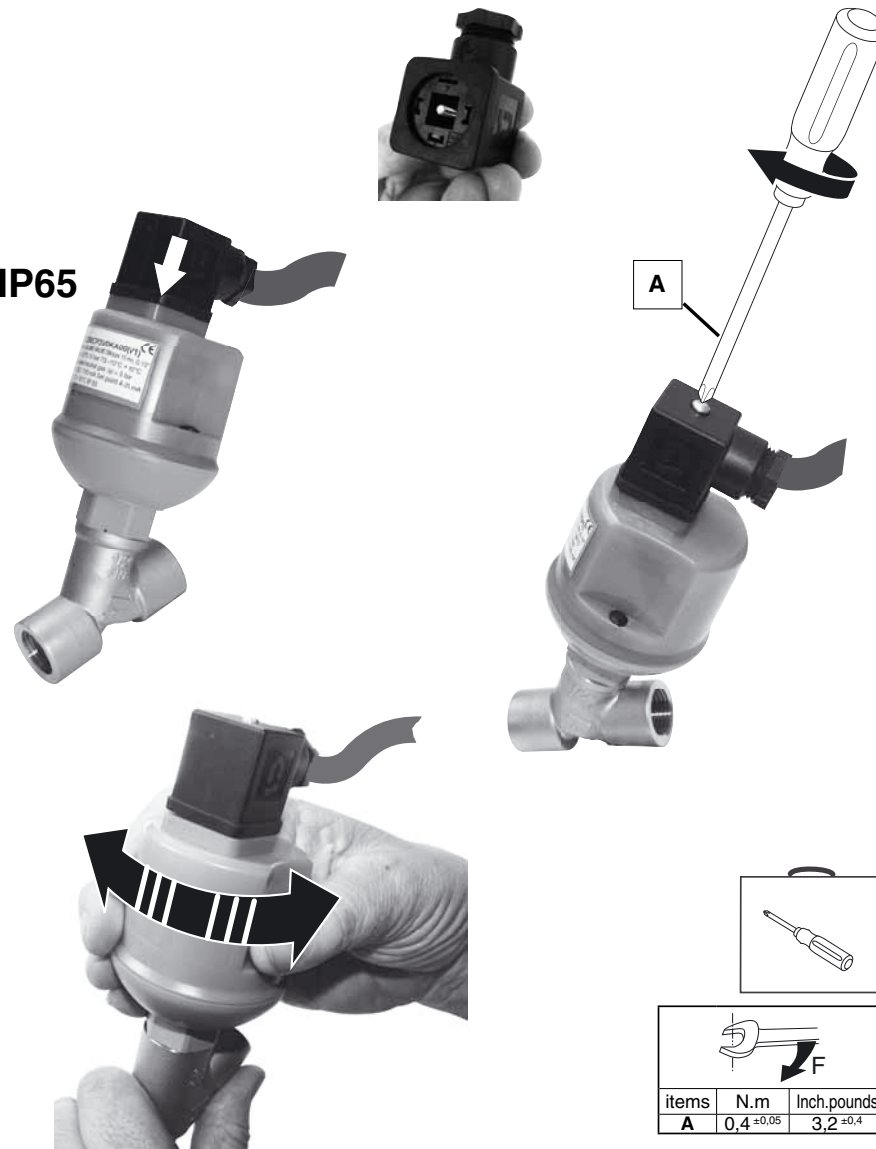

| items | N.m | Inch.pounds |
|----------|-----------|-------------|
| A | 0,4 ±0,05 | 3,2 ±0,4 |

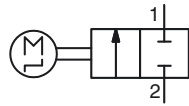

| | | | | | |
|-----------------|----|--------------------------|----|-----------------------|----|
| INIT PHASE | EN | PHASE D'INITIALISATION | FR | INITIALISATIONS PHASE | DE |
| FASE INICIACIÓN | ES | FASE DI INIZIALIZZAZIONE | IT | INITIALISATIEFASE | NL |
| FASE INICIAL | PT | НАЧАЛЬНЫЙ ЭТАП | RU | БАСТАПҚЫ ФАЗА | KZ |

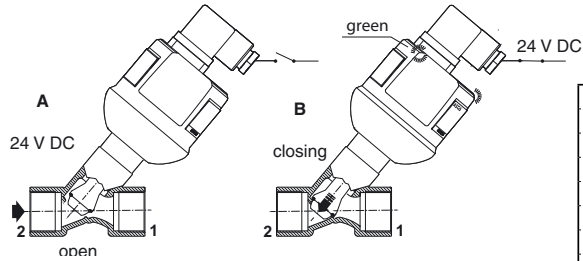

| | A | B |
|----|----------|-----------|
| FR | ouvert | fermeture |
| DE | Öffnen | Schließen |
| ES | apertura | cierre |
| IT | apertura | chiusura |
| NL | openen | sluiten |
| PT | abertura | fecho |
| RU | открытие | закрытие |
| KZ | ашу | жабу |

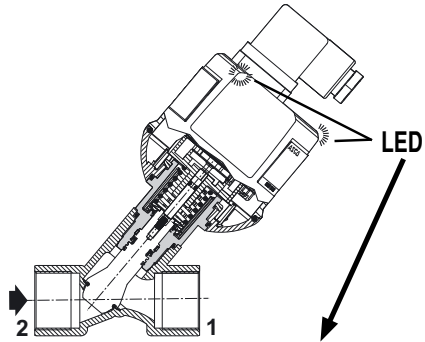

| LED | | | | |
|-----|------------|--------------|---------------------|----------------------|
| | valve OPEN | valve CLOSED | valve MOVES TO OPEN | valve MOVES TO CLOSE |
| EN | green | orange | green flashing | green flashing |
| FR | verte | orange | verte clignotante | verte clignotante |
| DE | grün | orange | grün blinkend | grün blinkend |
| ES | verde | naranja | verde intermitente | verde intermitente |
| IT | verde | arancione | verde lampeggiante | verde lampeggiante |
| NL | groen | oranje | groen knipperend | groen knipperend |
| PT | verde | laranja | verde intermitente | verde intermitente |
| RU | зеленый | оранжевый | зеленый мигающий | зеленый мигающий |
| KZ | жасыл | сарғылт | жасыл жыпықтайтын | жасыл жыпықтайтын |

| | | | | | | | |
|------|----------------------------|----|-----------------------------|----|------------------------------|----|--|
| ASCO | FUNCTIONNING DIAGRAM | EN | DIAGRAMME DE FONCTIONNEMENT | FR | FUNKTIONSSCHEMA | DE | |
| | DIAGRAMA DE FUNCIONAMIENTO | ES | DIAGRAMMA DI FUNZIONAMENTO | IT | WERKING SCHEMA | NL | |
| | DIAGRAMA DE FUNCIONAMENTO | PT | СХЕМА РАБОТЫ | RU | закончите работу диаграммасы | KZ | |

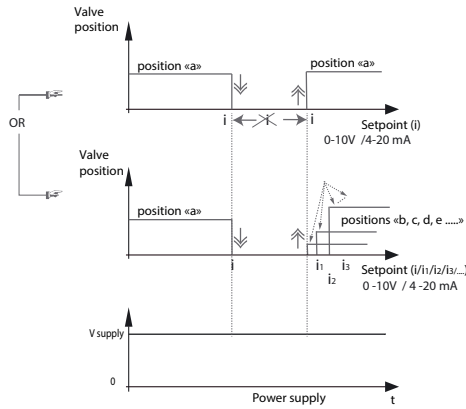

| | |
|-------------------------|----|
| lost setpoint | EN |
| perte de consigne | FR |
| Sollwertausfall | DE |
| pérdida de consigna | ES |
| Interruzione setpoint | IT |
| verloren setpoint | NL |
| setpoint perdido | PT |
| потерял уставки | RU |
| жоғалған орнатылған мән | KZ |

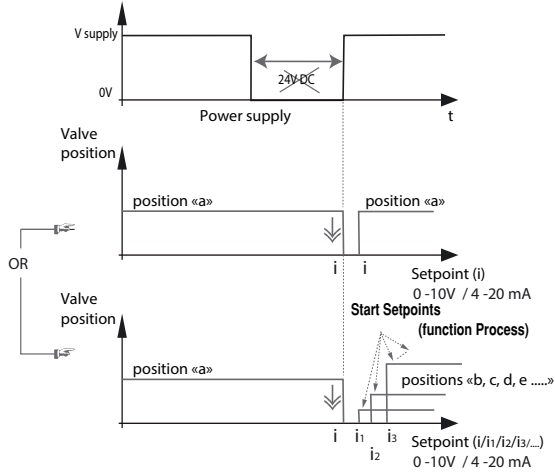

| | |
|---------------------------------|----|
| lost supply | EN |
| perte alimentation | FR |
| Ausfall der Spannungsversorgung | DE |
| pérdida de alimentación | ES |
| Interruzione alimentazione | IT |
| verloren levering | NL |
| alimentação perdida | PT |
| потерял питания | RU |
| жоғалған қуат көзі | KZ |