

1

2

3

A

A

B

B

C

C

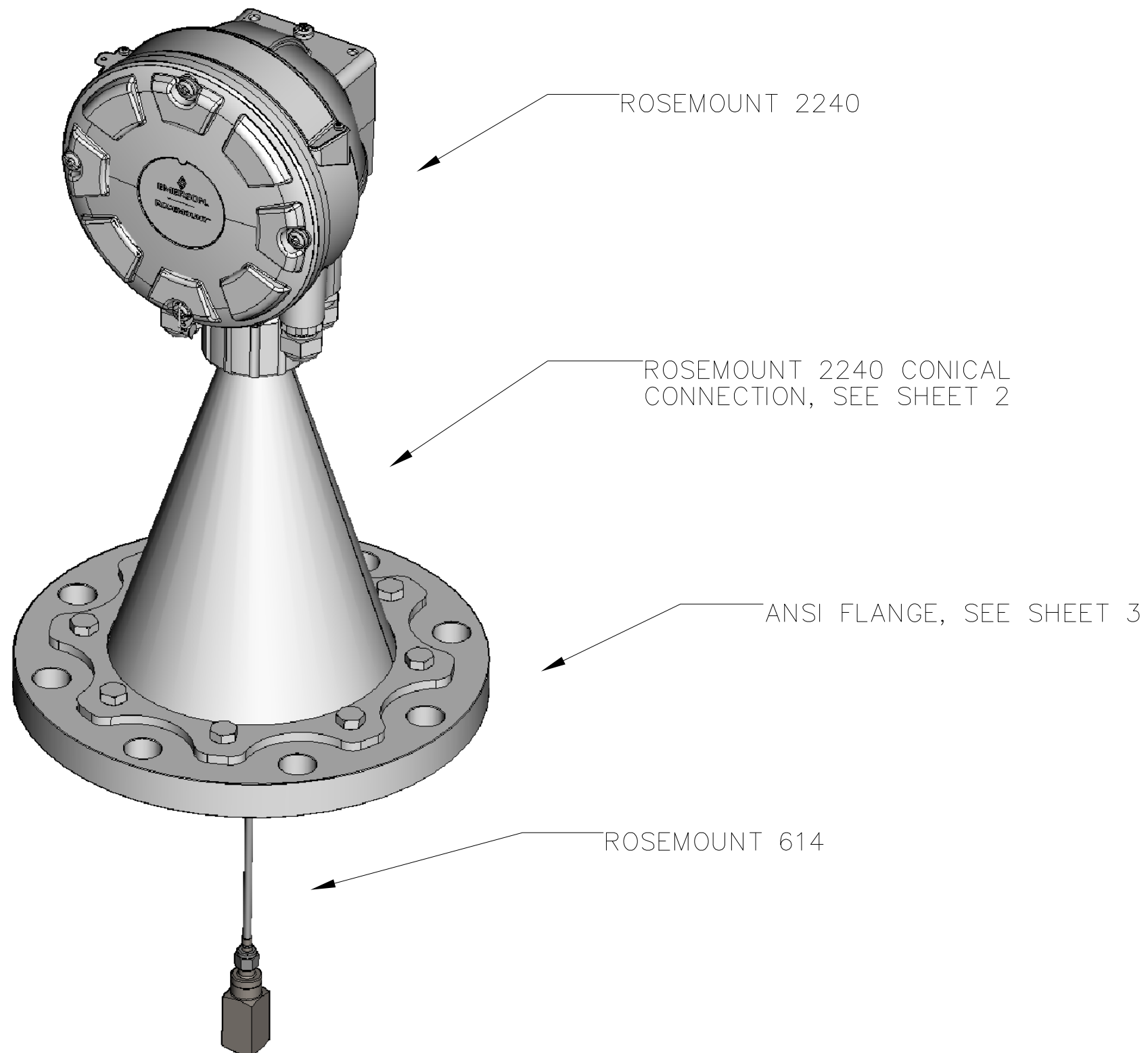

ROSEMOUNT 2240

ROSEMOUNT 2240 CONICAL CONNECTION, SEE SHEET 2

ANSI FLANGE, SEE SHEET 3

ROSEMOUNT 614

2019-06-25 Electronic Master - Printed Copies Uncontrolled - Emerson Proprietary

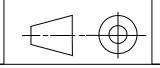
ISSUED BY TP-HH		DRAWN WEEK 1917	PRODUCT CODE 5900	 LAYOUTVAGEN 1, 435 33 MÖLNLYCKE, SWEDEN
APPROVED BY TT-CH		APP'D WEEK 1917	DOCUMENT TYPE 02	
ORIGINAL DRAWING NO. 9261085-039	SIZE A3	1 ST ANGLE 	SCALE 1:1	INSTALLATION DRAWING TITLE 2240/614 ACCESSORY CONICAL CONNECTION
CAD MAINTAINED, (ACAD)		DO NOT SCALE PRINT		DRAWING NO. 9261085-039
<small>THE COPYRIGHT/OWNERSHIP OF THIS DOCUMENT IS AND WILL REMAIN OURS. THE DOCUMENT MUST NOT BE USED WITHOUT AUTHORIZATION OR BROUGHT TO THE KNOWLEDGE OF A THIRD PARTY. CONTRAVENTION WILL BE PROSECUTED. ROSEMOUNT TANK RADAR AB, SWEDEN</small>				ISSUE 02
				SHEET 1/4

1

2

3

INST DWG A3 120605

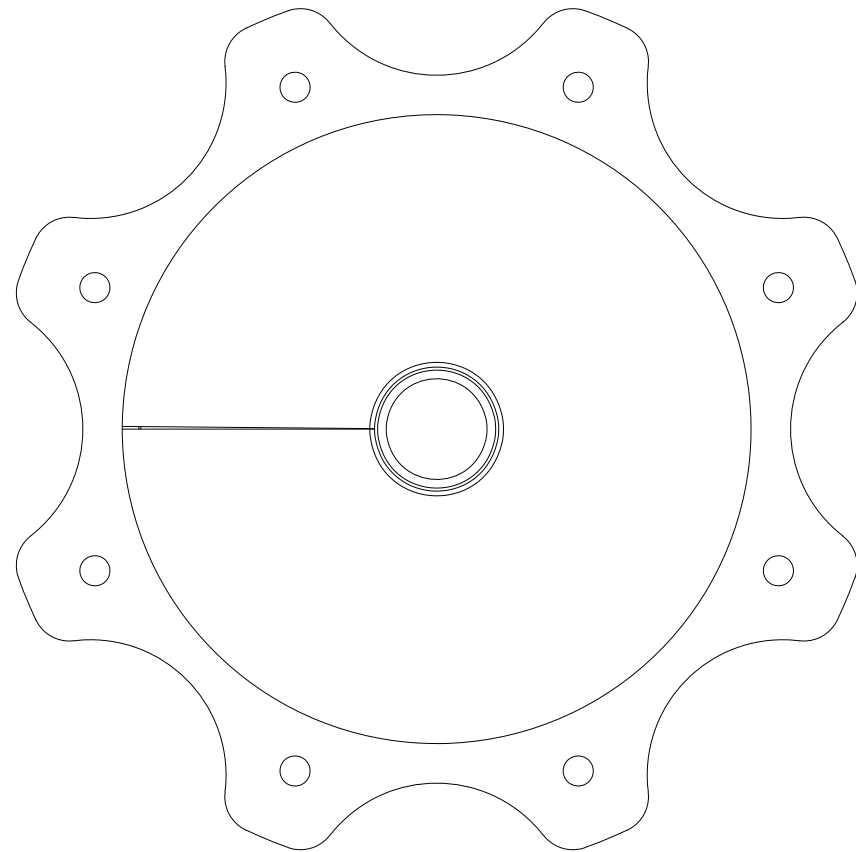
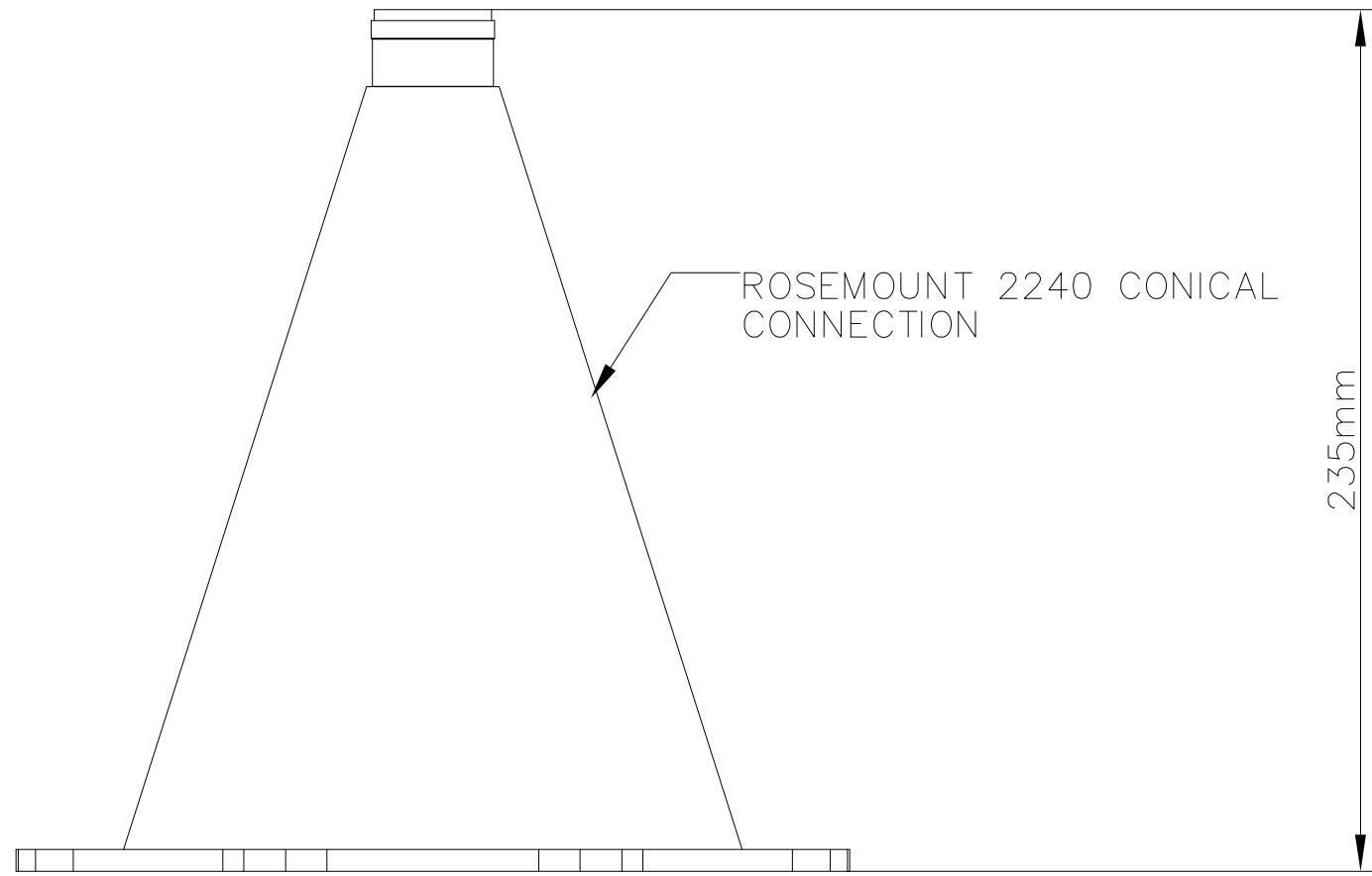

1. ONLY THE GASKET FOR THE MOUNTING CONE IS INCLUDED

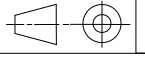
ISSUED BY TP-HH		DRAWN WEEK 1917	PRODUCT CODE 5900	 LAYOUTVAGEN 1, 435 33 MÖLNLYCKE, SWEDEN
APPROVED BY TT-CH		APP'D WEEK 1917	DOCUMENT TYPE 02	
ORIGINAL DRAWING NO. 9261085-039	SIZE A3	1 ST ANGLE 	SCALE 1:1	INSTALLATION DRAWING TITLE 2240/614 ACCESSORY CONICAL CONNECTION
CAD MAINTAINED, (ACAD)		DO NOT SCALE PRINT		DRAWING NO. 9261085-039
<small>THE COPYRIGHT/OWNERSHIP OF THIS DOCUMENT IS AND WILL REMAIN OURS. THE DOCUMENT MUST NOT BE USED WITHOUT AUTHORIZATION OR BROUGHT TO THE KNOWLEDGE OF A THIRD PARTY. CONTRAVENTION WILL BE PROSECUTED. ROSEMOUNT TANK RADAR AB, SWEDEN</small>				ISSUE 02
				SHEET 2/4

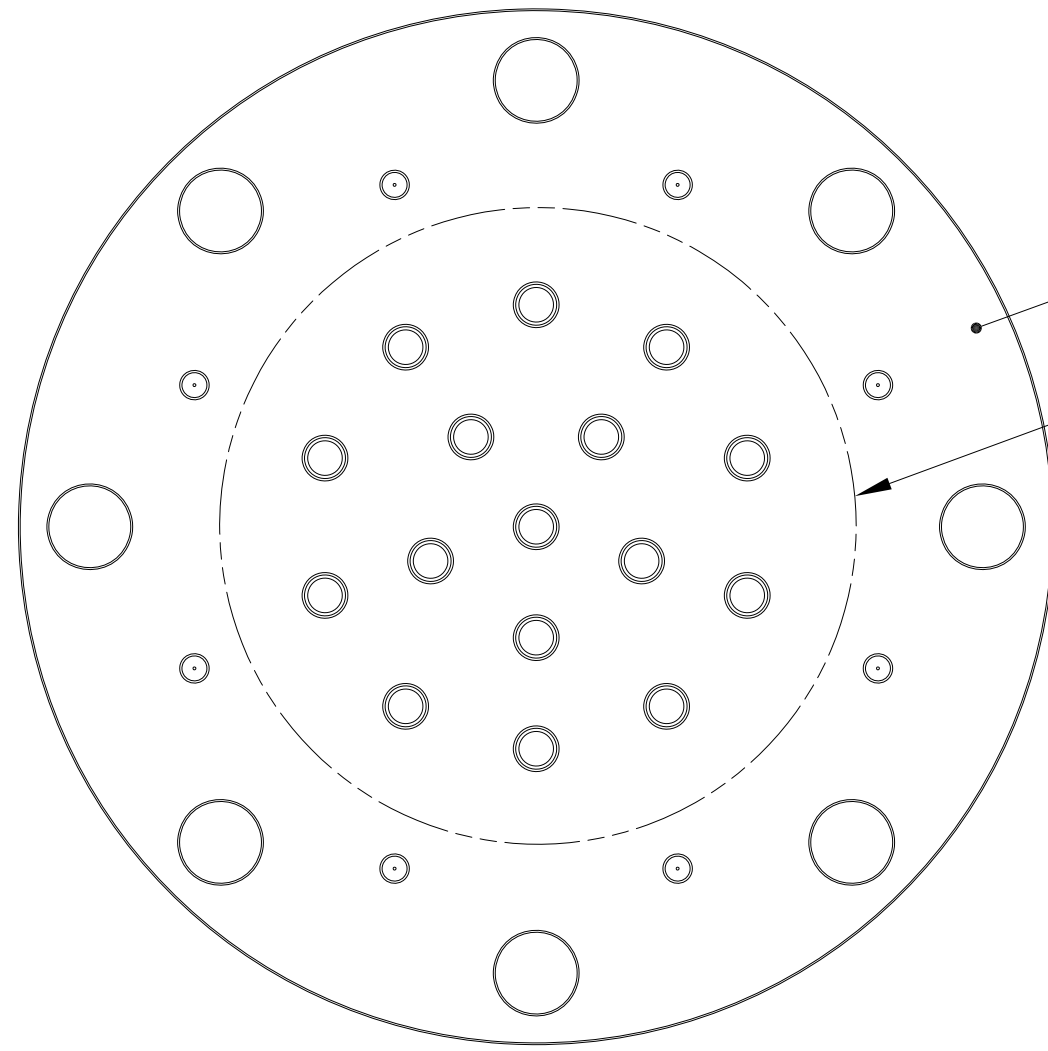

ANSI FLANGE, SEE TABLE 1 FOR DIFFERENT FLANGE SIZES AND NUMBER OF HOLES

AREA FOR ROSEMOUNT 614 HOLE PATTERN

TABLE 1 - MAX NO. OF HOLES		
ANSI	1/8 NPT	1/2 NPT
6"	16	8
8"	16	8
12"	16	8
16"	*	*
20"	*	*

* MORE THAN 16 HOLES, CONSULT FACTORY

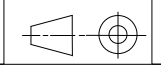
ISSUED BY TP-HH		DRAWN WEEK 1917	PRODUCT CODE 5900	 LAYOUTVAGEN 1, 435 33 MÖLNLYCKE, SWEDEN
APPROVED BY TT-CH		APP'D WEEK 1917	DOCUMENT TYPE 02	
ORIGINAL DRAWING NO. 9261085-039	SIZE A3	1 ST ANGLE 	SCALE 1:1	INSTALLATION DRAWING TITLE 2240/614 ACCESSORY CONICAL CONNECTION
CAD MAINTAINED, (ACAD)		DO NOT SCALE PRINT		DRAWING NO. 9261085-039
<small>THE COPYRIGHT/OWNERSHIP OF THIS DOCUMENT IS AND WILL REMAIN OURS. THE DOCUMENT MUST NOT BE USED WITHOUT AUTHORIZATION OR BROUGHT TO THE KNOWLEDGE OF A THIRD PARTY. CONTRAVENTION WILL BE PROSECUTED. ROSEMOUNT TANK RADAR AB, SWEDEN</small>				ISSUE SHEET 02 3/4

2019-06-25 Electronic Master - Printed Copies Uncontrolled - Emerson Proprietary

1

2

3

CROSS SECTION FOR INSTALLATION AND ILLUSTRATION

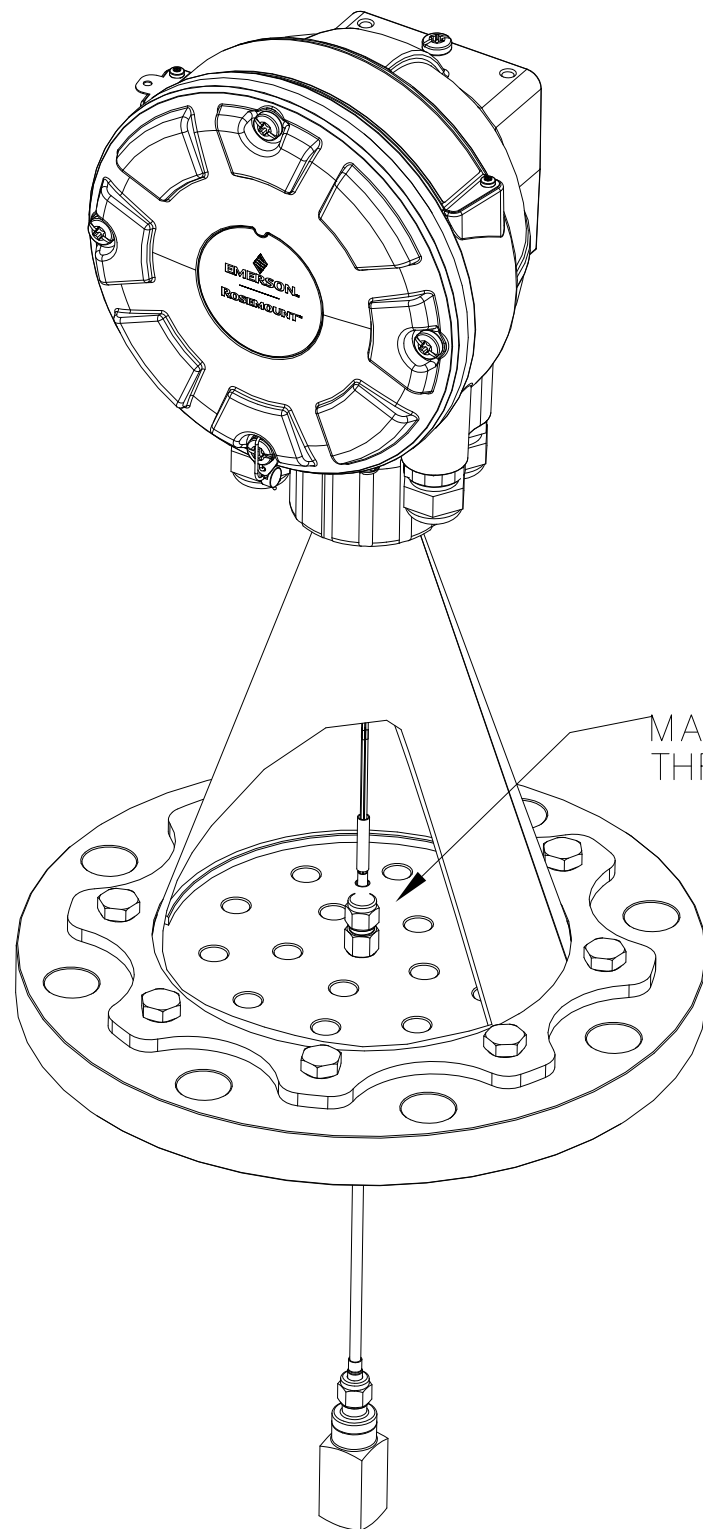
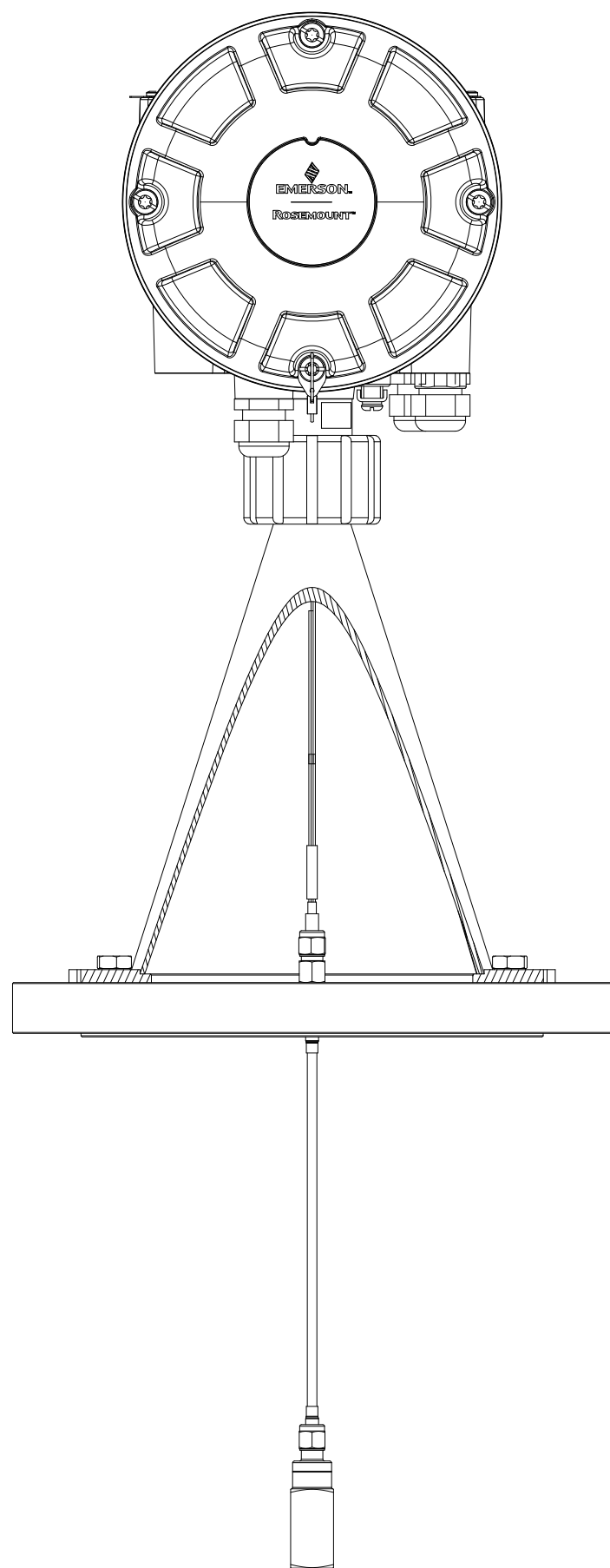

MAX. TORQUE: 16NM FOR NPT
THREAD AND COMPRESSION NUT

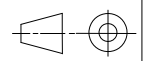
ISSUED BY TP-HH		DRAWN WEEK 1917	PRODUCT CODE 5900	 LAYOUTVAGEN 1, 435 33 MÖLNLYCKE, SWEDEN
APPROVED BY TT-CH		APP'D WEEK 1917	DOCUMENT TYPE 02	
ORIGINAL DRAWING NO. 9261085-039	SIZE A3	1 ST ANGLE 	SCALE 1:1	INSTALLATION DRAWING TITLE 2240/614 ACCESSORY CONICAL CONNECTION
CAD MAINTAINED, (ACAD)		DO NOT SCALE PRINT		DRAWING NO. 9261085-039
<small>THE COPYRIGHT/OWNERSHIP OF THIS DOCUMENT IS AND WILL REMAIN OURS. THE DOCUMENT MUST NOT BE USED WITHOUT AUTHORIZATION OR BROUGHT TO THE KNOWLEDGE OF A THIRD PARTY. CONTRAVENTION WILL BE PROSECUTED. ROSEMOUNT TANK RADAR AB, SWEDEN</small>				ISSUE 02
				SHEET 4/4

2019-06-25 Electronic Master - Printed Copies Uncontrolled - Emerson Proprietary

1

2

3

INST DWG A3 120605