

Shafer SH-Series 9.0

Hydraulic Double-acting Balanced Rotary Actuator 90° Quarter-turn

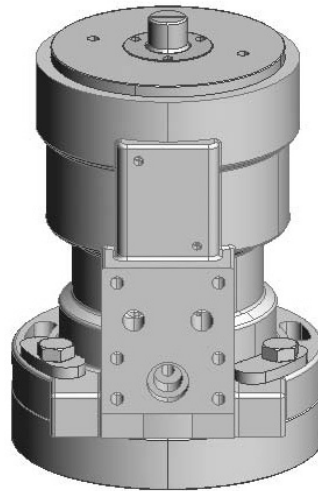

Pressure Range:	225 psig to 1,500 psig
Burst Test:	9790 psig
Total Dry Weight including Mounting Hardware:	73 lb
Oil Volume:	0.11 gal
Temperature Range:	-20°F to 120°F
Rotation:	90°±1°
Hydraulic Fluid And Viscosity:	We recommend acid-free hydraulic oil. Viscosity range 13-35 cSt @ 40°C (85-120 SUS @ 104°F). For recommended brands and other types of fluid, please refer to separate data sheet.

Table of Contents

Section 1: Main Dimensions

Dimensions1

Section 2: Performance

Performance2

Main Dimensions

Actuator shown in closed position

A Port: Close (Clockwise seen from above)

B Port: Open

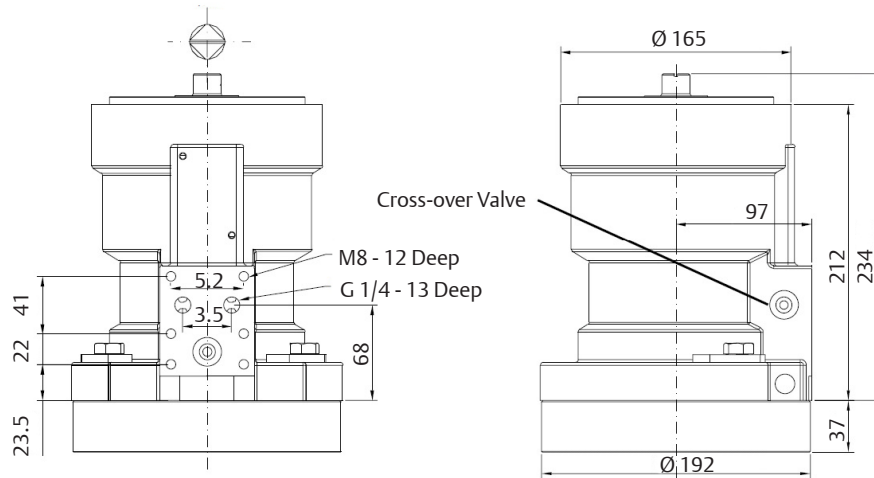

All dimensions in mm.

Valve Adaption:

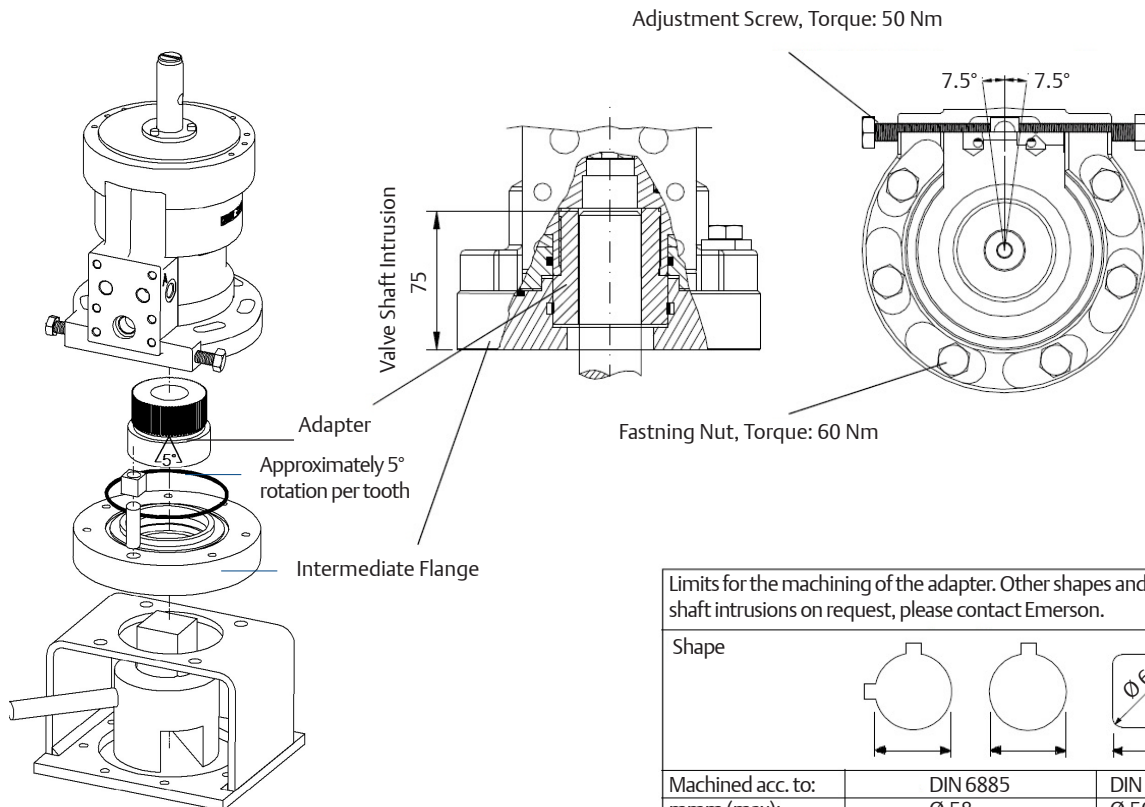

All dimensions in mm.

Performance

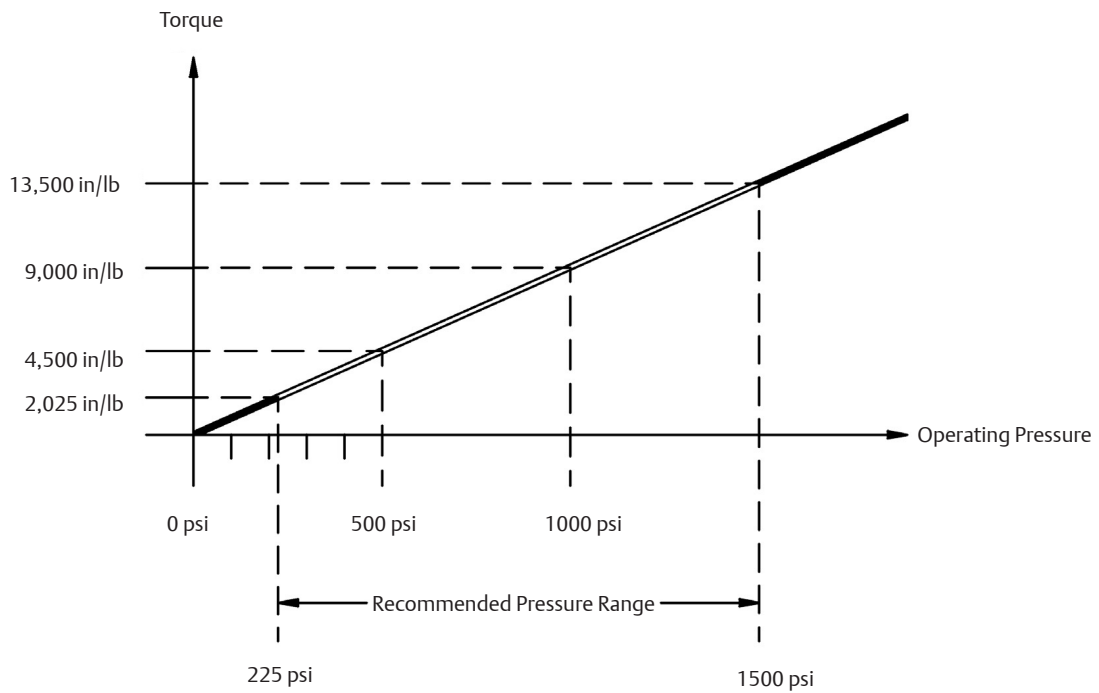

World Area Configuration Centers (WACC) offer sales support, service, inventory and commissioning to our global customers. Choose the WACC or sales office nearest you:

NORTH & SOUTH AMERICA

19200 Northwest Freeway
Houston TX 77065
USA
T +1 281 477 4100

Av. Hollingsworth
325 Iporanga Sorocaba
SP 18087-105
Brazil
T +55 15 3413 8888

ASIA PACIFIC

No. 9 Gul Road
#01-02 Singapore 629361
T +65 6777 8211

No. 1 Lai Yuan Road
Wuqing Development Area
Tianjin 301700
P. R. China
T +86 22 8212 3300

MIDDLE EAST & AFRICA

P. O. Box 17033
Jebel Ali Free Zone
Dubai
T +971 4 811 8100

P. O. Box 10305
Jubail 31961
Saudi Arabia
T +966 3 340 8650

24 Angus Crescent
Longmeadow Business Estate East
P.O. Box 6908 Greenstone
1616 Modderfontein Extension 5
South Africa
T +27 11 451 3700

EUROPE

Holland Fasor 6
Székesfehérvár 8000
Hungary
T +36 22 53 09 50

Strada Biffi 165
29017 Fiorenzuola d'Arda (PC)
Italy
T +39 0523 944 411

For complete list of sales and manufacturing sites, please visit www.emerson.com/actuationtechnologieslocations or contact us at info.actuationtechnologies@emerson.com

www.emerson.com/shafer

©2018 Emerson. All rights reserved.

The Emerson logo is a trademark and service mark of Emerson Electric Co. Shafer™ is a mark of one of the Emerson family of companies. All other marks are property of their respective owners.

The contents of this publication are presented for information purposes only, and while every effort has been made to ensure their accuracy, they are not to be construed as warranties or guarantees, express or implied, regarding the products or services described herein or their use or applicability. All sales are governed by our terms and conditions, which are available on request. We reserve the right to modify or improve the designs or specifications of our products at any time without notice.