

Proximity switches

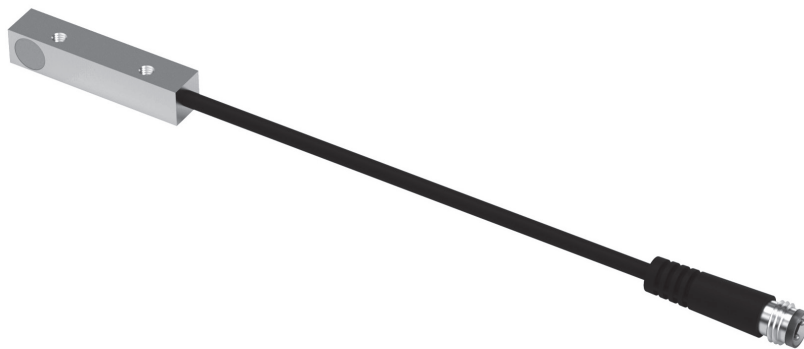

Table of contents: Proximity switches

Proximity switches	
	Page
Proximity switches	73
Accessories proximity switches	77

	50448226	50001023	50448225	50093507	11016714	50003811	11005439	50230625	50428013	50313987	50536020	50033432	11012933	50562677	
CS 6															
CS 8															
CS 12															
CS 16															
ZA-CS 16															
CS 20															
ZA-CS 20															
CS 25															
ZA-CS 25															
LM 12															
LM 16															
LM 20															
LM 25															
ZA 20/25															
LM 32															
ZA 32															
HM 10															
HM 16															
HM 25															
PMP															
ZA-PMP															
PMP-c															
PEZ-52															
PEZ-65															
PEZ-80															
PEZ-100															
PDZ-128															
PDZ-160															
PDZ-200															
CR 12															
CR 16															
CR 20															
CR 25															
CR 32															
RM 12															
RMZ 12															
RM 16															
RM 25															
RM 32															
PG 12															
PG 16															
PG 20															
UG 20															
UG 25															
GMO 12															
GMO 20															
GMO 32															
DG 16															
DG 20															

INI d3x12-Sn0.8-PNP-NO
 INI d3x22-Sn0.8-PNP-NO-M8x1
 INI M4x12-Sn0.8-PNP-NO
 INI d4x2.5-Sn1.0-PNP-NC-M8x1
 INI d4x2.5-Sn1.0-PNP-NO-M8x1
 INI d6.5x3.5-Sn1.5-PNP-NO-M8x1
 INI d6.5x4.4-Sn1.5-PNP-NO-M8x1
 INI 8x4.7x16-Sn2.0-PNP-NC-M8x1
 INI 8x8x38.5-Sn1.5-PNP-NO-M8x1
 INI c10x19.5-Em-PNP-NO-M8x1
 INI c10x19.5-Em-PNP-NO-M8x1 black
 INI c10x28.5-Em-PNP-NO-M8x1
 INI 10.5x5.8x30-Em-PNP-NO-M8x1
 INI c10x20-Em-PNP-NO-M8x1

Standard Alternative
 Proximity switches nomenclature
 d: Diameter
 Em: Electromagnetic
 Sn: Switching distance
 PNP: PNP
 NO: Normally open
 NC: Normally close
 M8x1: Connection thread

Proximity switches

INI d3x12-Sn0.8-PNP-NO

Order number 50448226

Net weight 0.01 kg

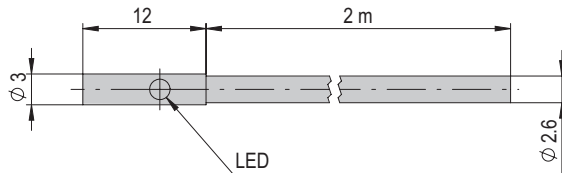

INI d3x22-Sn0.8-PNP-NO-M8x1

Order number 50001023

Net weight 0.005 kg

Operating voltage 10 - 30 VDC

Switching distance 0.8 mm

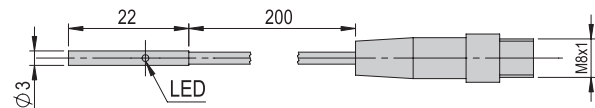

INI d4/6.5x45-Sn1.0-PNP-NO-M8x1

Order number 11009034

Net weight 0.008 kg

Operating voltage 10 - 30 VDC

Switching distance 0.8 mm

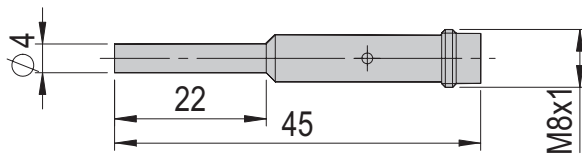

INI d4x25-Sn1.0-PNP-NC-M8x1

Order number 50093507

Net weight 0.004 kg

Operating voltage 10 - 30 VDC

Switching distance 1.0 mm

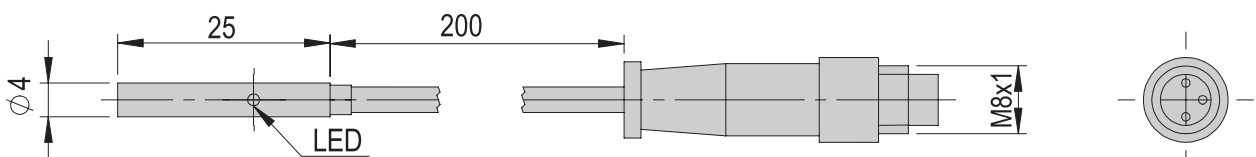

INI d4x25-Sn1.0-PNP-NO-M8x1

Order number 11016714

Net weight 0.002 kg

Operating voltage 10 - 30 VDC

Switching distance 1.0 mm

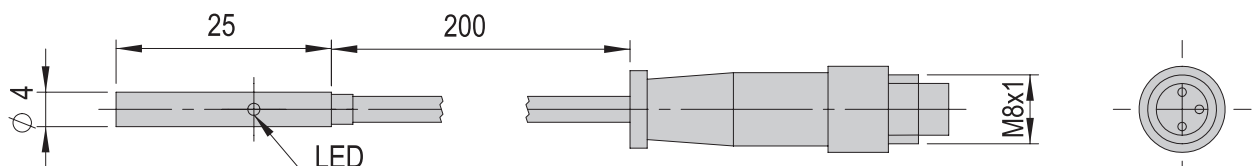

INI M4x12-Sn0.8-PNP-NO

Order number 50448225

Net weight 0.01 kg

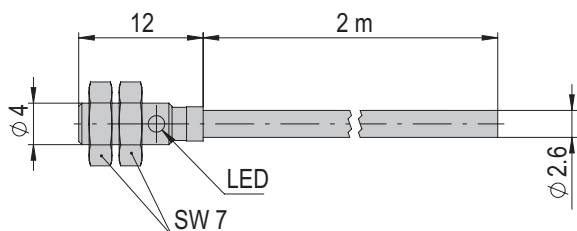

INI d5x36-Sn2.0-PNP-NC-M8x1

Order number 50285525

Net weight 0.007 kg

Operating voltage 10 - 30 VDC

Switching distance 1.5 mm

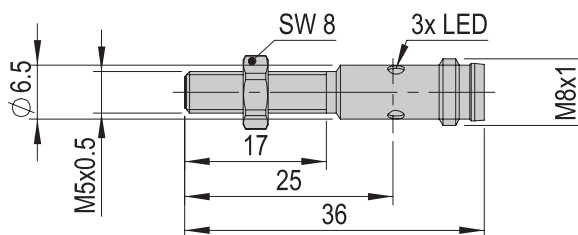

INI 6.3x4.7x26.3-Em-PNP-NO-M8x1

Order number 11010759

Net weight 0.007 kg

Operating voltage 10 - 30 VDC

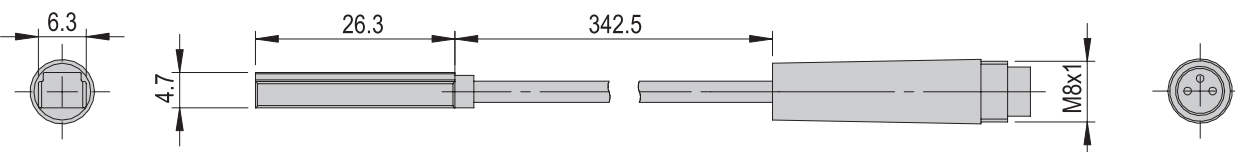

INI d6.5x35-Sn1.5-PNP-NO-M8x1

Order number 50003811

Net weight 0.009 kg

Operating voltage 10 - 30 VDC

Switching distance 1.5 mm

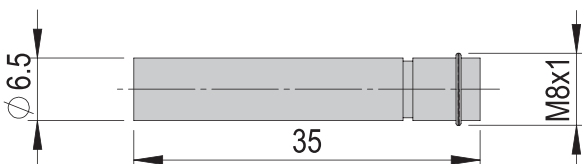

INI d6.5x44-Sn1.5-PNP-NO-M8x1

Order number 11005439

Net weight 0.005 kg

Operating voltage 10 - 30 VDC

Switching distance 1.5 mm

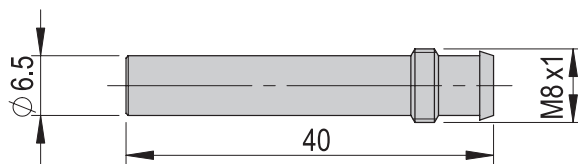

INI 8x4.7x16-Sn2.0-PNP-NC-M8x1

Order number 50230625

Net weight 0.004 kg

Operating voltage 10 - 30 VDC

Switching distance 1.5 mm

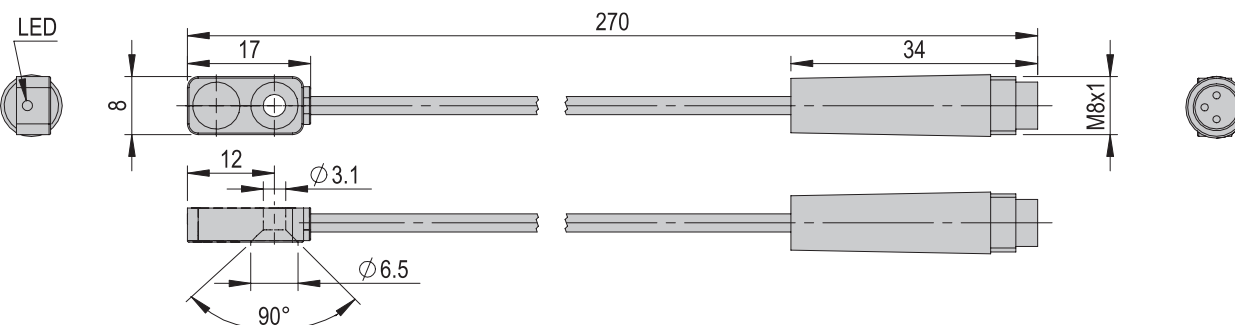

INI 8x8x38.5-Sn1.5-PNP-NO-M8x1

Order number	50428013
Net weight	0.043
Operating voltage	10 - 30 VDC
Switching distance	1.5 mm

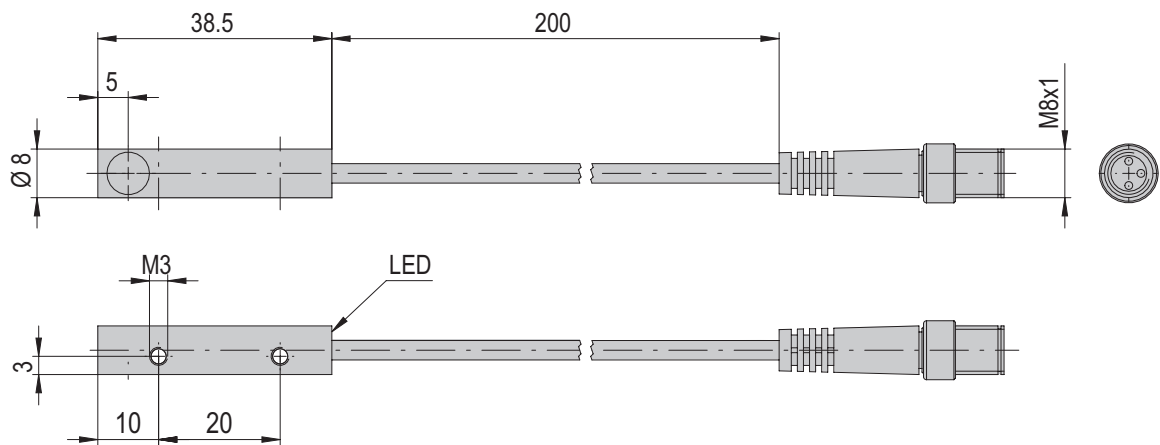

6

INI c10x19.5-Em-PNP-NO-M8x1

Order number	50313987
Net weight	0.021 kg
Operating voltage	10 - 30 VDC

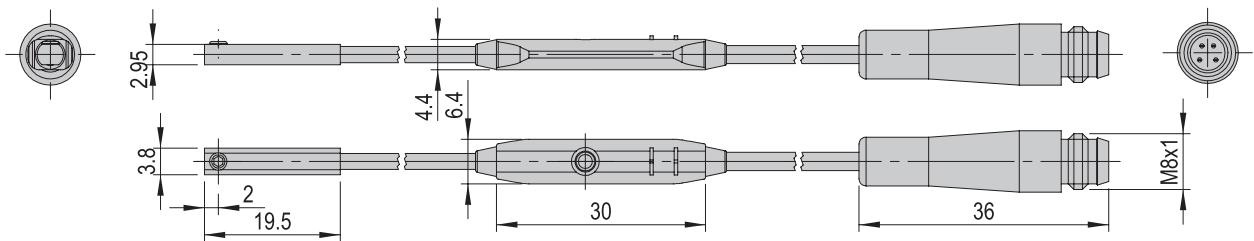

INI c10x28.5-Em-PNP-NO-M8x1

Order number	50033432
Net weight	0.02 kg
Operating voltage	10 - 30 VDC

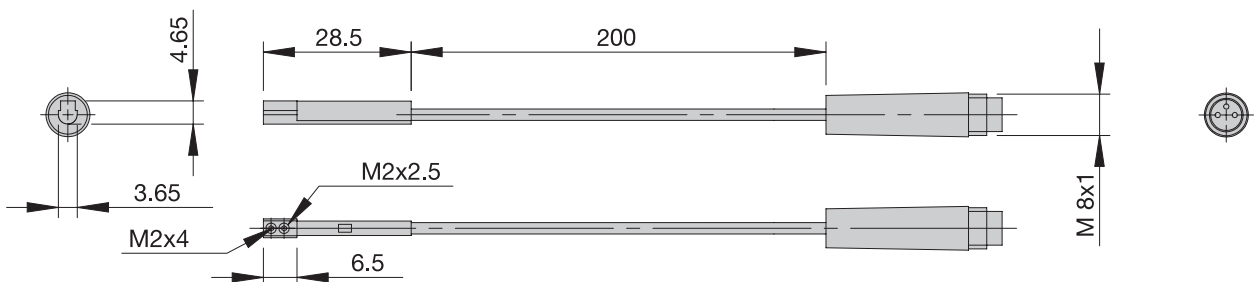

INI 10.5x5.8x30-Em-PNP-NO-M8x1

Order number	11012933
Net weight	0.013 kg
Operating voltage	10 - 30 VDC

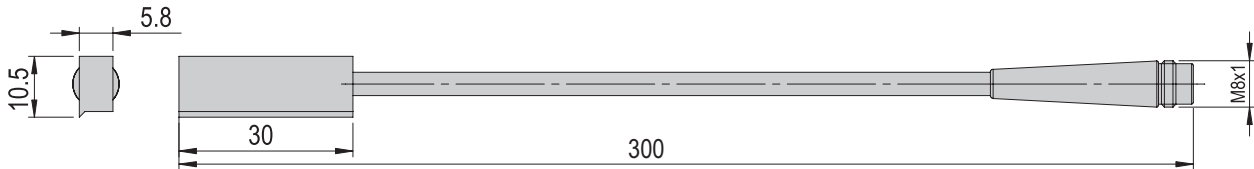

INI c10x19.5-Em-PNP-NO-M8x1-black

Order number	50536020
Net weight	0.021 kg
Operating voltage	10 - 30 VDC

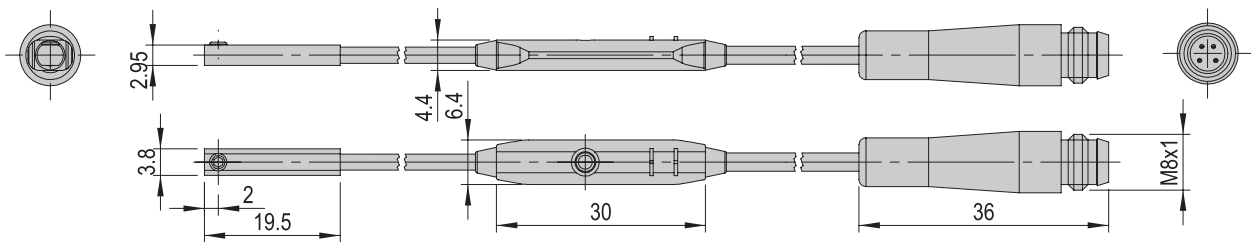

INI c10x20-Em-PNP-NO-M8x1

Order number	50562677
Net weight	0.021 kg
Operating voltage	10 - 30 VDC

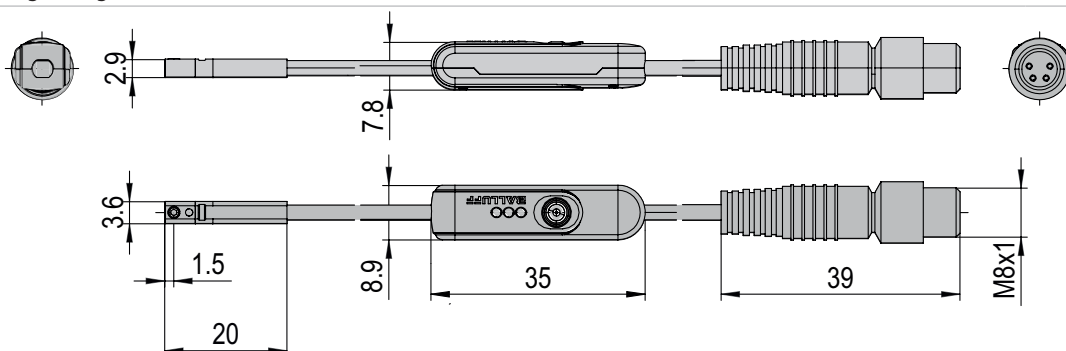

Accessories proximity switches

Clamping nut M6x1

Order number 50042748

Net weight 0.001 kg

Ø 4 mm

Thread M6 x 1 mm

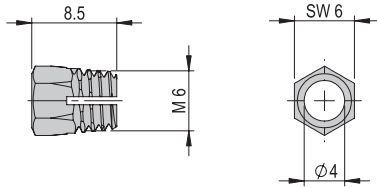

Clamping nut M8x0.75

Order number 11005436

Net weight 0.001 kg

Ø 6.5 mm

Thread M8 x 0.75 mm

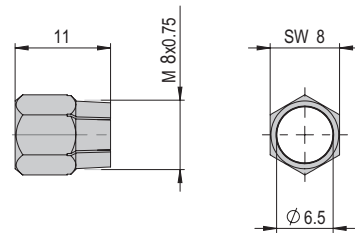

Proximity switch holder IH9.5/8x8

Order number 11004997

Net weight 0.021 kg

Ø 8x8 mm

Material Die-cast zinc

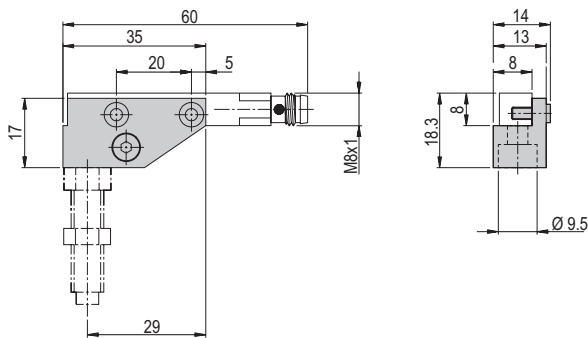

Proximity switch holder IH10/6.5

Order number 11004995

Net weight 0.015 kg

Ø 6.5 mm

Material Brass nickel-plated

