

Lifting modules HM

HM 10 - HM 25

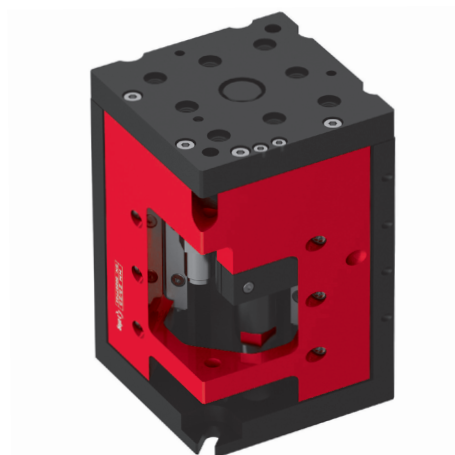
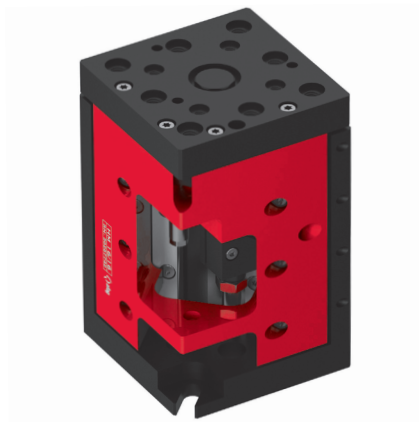
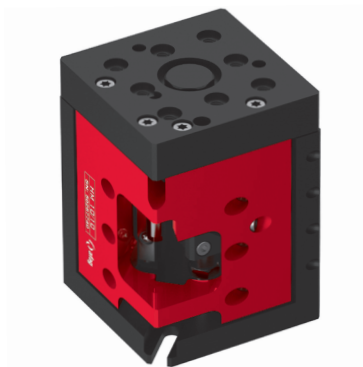
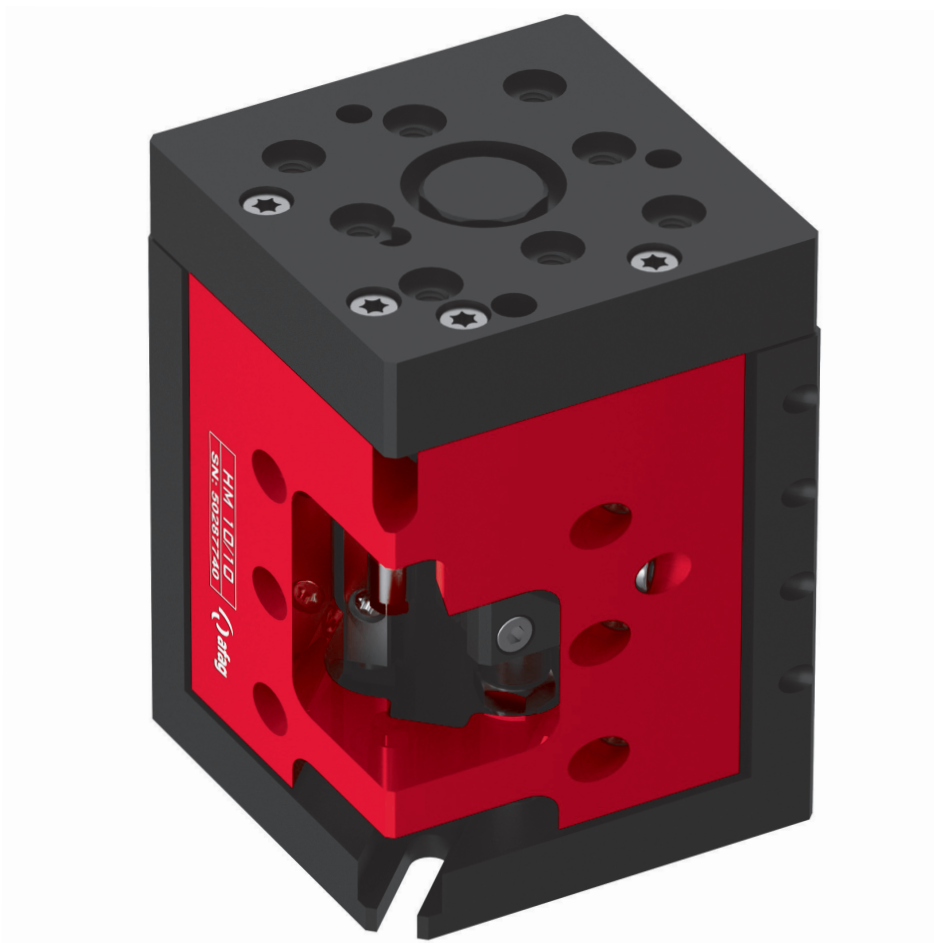

Table of contents: HM

Lifting modules HM		Page
HM 10		97
HM 16		103
HM 25		109

Lifting modules HM

HM 10



- Torsion-resistant
- Short build
- Simple table installation

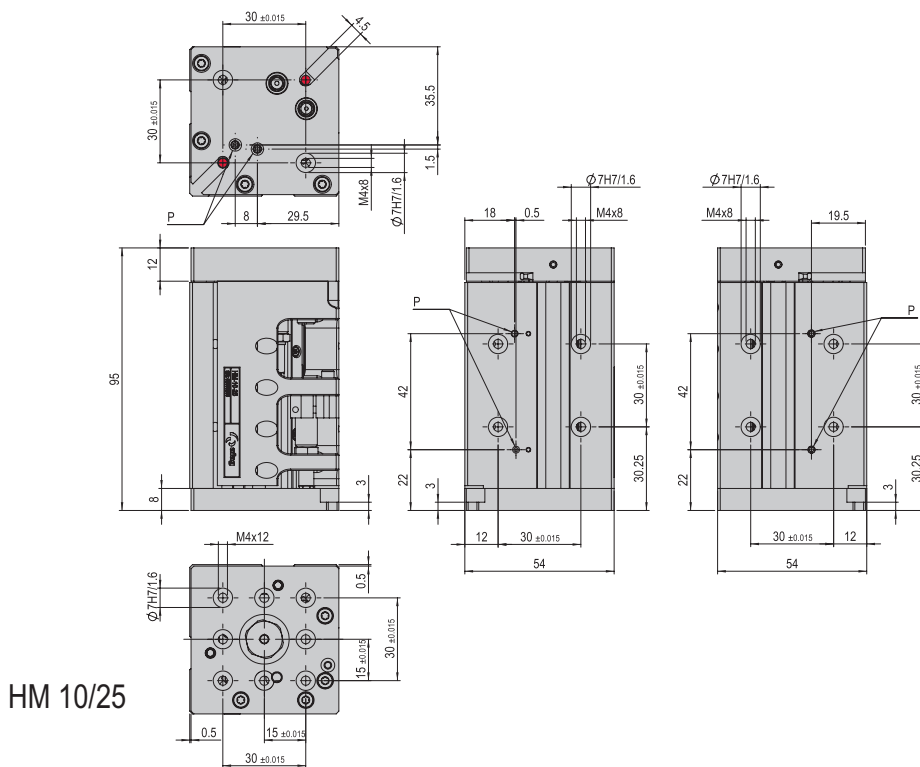
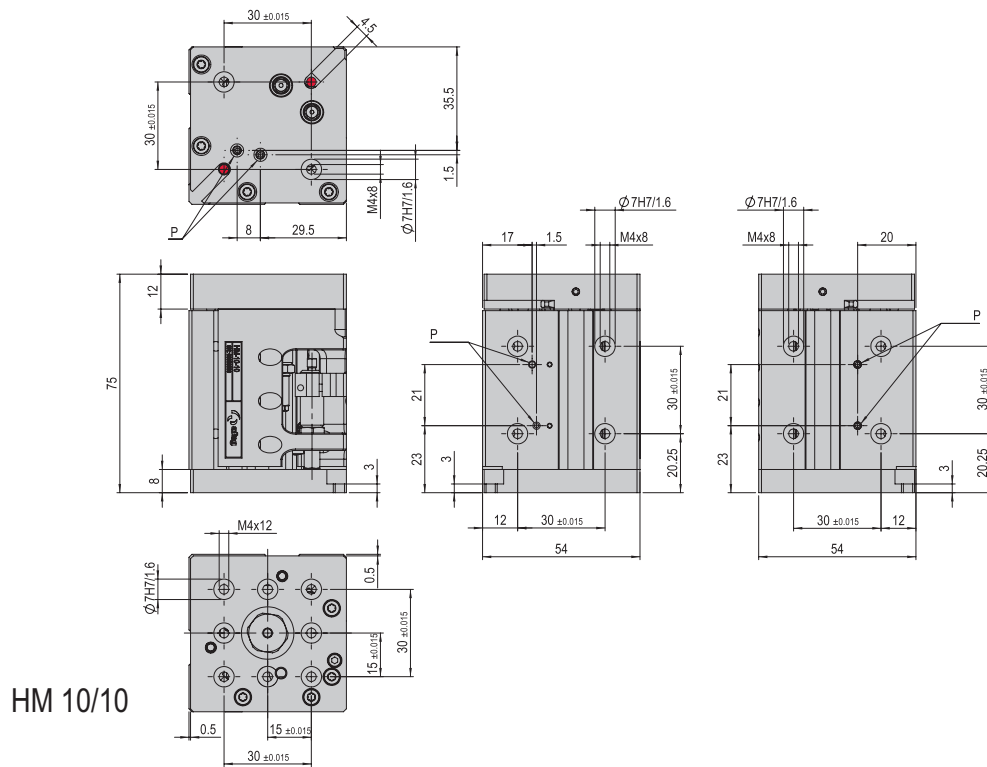

 Bores can be screwed through

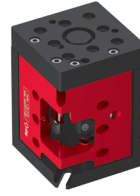

HM 10	
Attachment grid	30 x 30 mm
Attachment thread	M4
Operating pressure	6 +/- 2 bar
Air connection P	M3
Cylinder Ø	10 mm
Retract piston force	35 N
Extend piston force	47 N
Operating temperature	0 - 50 °C
Storage temperature	0 - 50 °C
Humidity	< 90 %
Medium filtered compressed air	10 - 40 µm

Type	HM 10/10	HM 10/25
Order number	50287740	50287741
Stroke H	10 mm	25 mm
Net weight	0.519 kg	0.638 kg
Max. payload	1.2 kg	0.9 kg
Air consumption/cycle	0.007 NL	0.016 NL
Noise level	< 65 dB (A)	< 65 dB (A)
Repeat accuracy	+/- 0.01 mm	+/- 0.01 mm
Load balance (LA)	10 N	8.8 N
Mounting position	✦	✦

The technical data refer to a nominal pressure of 6 bar under Afag standard test conditions.
 Note: The load balance supports the extension stroke and damps the retraction stroke.
 The module can be operated with lubricated or dry air.
 Cleanroom class ISO 14644-1, class ISO 7

Included in the delivery (Catalogue HT accessories)

- 2x Centering bushing Ø7x3
- 2x Mounting screw M4x8
- 2x Mounting screw M4x12
- 2x Washer M4
- 2x Shock absorber SD M6x0.5 -3
- 2x Stop sleeve ASH M8x1 -1

Accessories (Catalogue HT accessories)

- Compressed air connection angled M3 x 0.5
- Compressed air connection straight M3 x 0.5
- INI c10x19.5-Em-PNP-NO-M8x1

Alternative accessories (Catalogue HT accessories)

- INI c10x28.5-Em-PNP-NO-M8x1

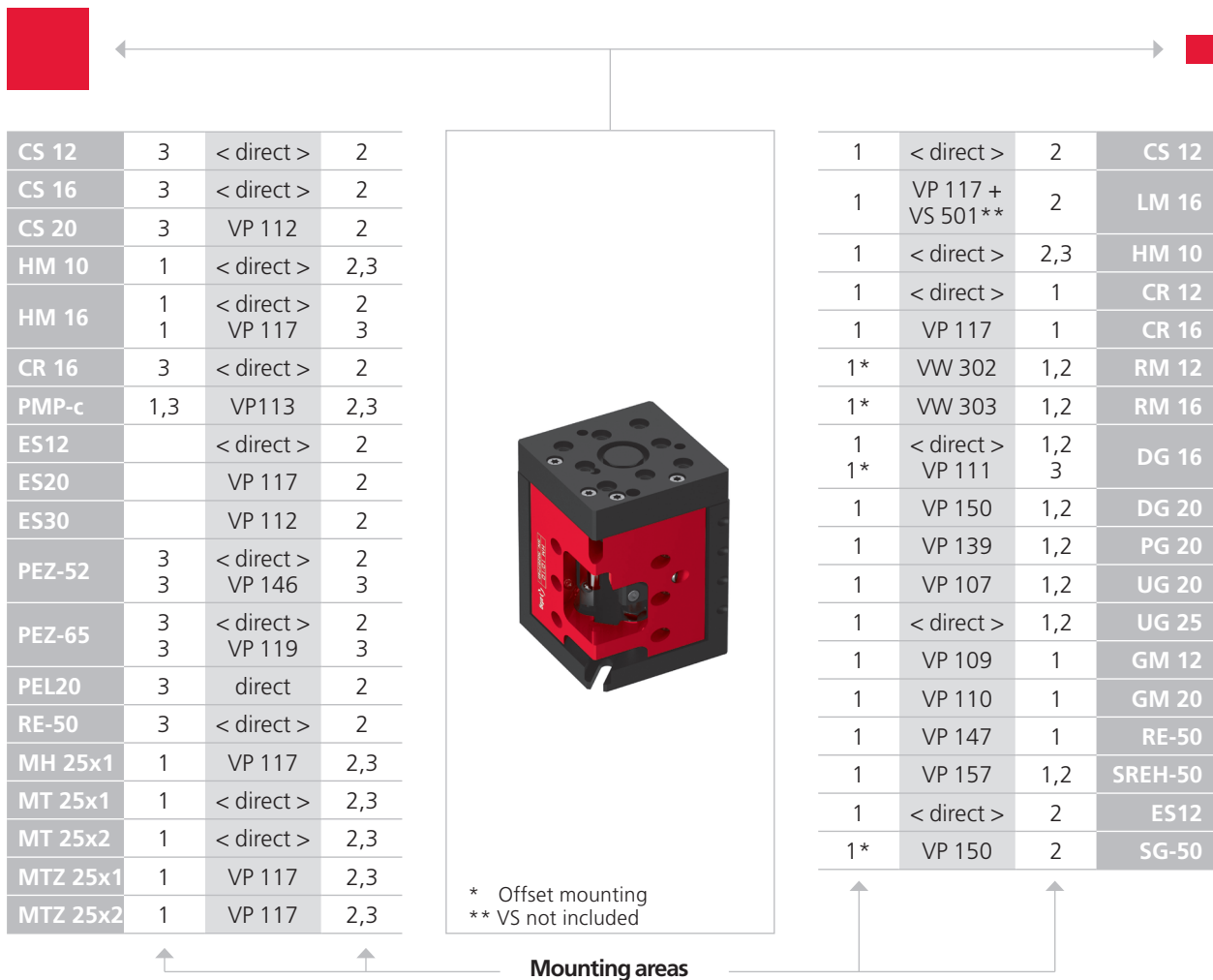

CS, ES	LM	HM	SA	UG, GM, SG, DG, PG, GE, SGE
PMP, PMP-c	PEZ, PDZ	PEL, PDL	RM, RE	CR, RM 32, RE, SREH, RA

Note that there might be different mounting positions from one module to another one.
The required connection elements and the range of support columns are depicted in the catalogue HT accessories.

Type	HM 10/10	HM 10/25
Max. static torque M_x	11 Nm	14 Nm
Max. static torque M_y	7 Nm	7 Nm
Max. static torque M_z	7 Nm	7 Nm
Max. effective force F_y	180 N	150 N
Max. effective force F_z	180 N	150 N
Effective distance W_x	38 mm	45 mm

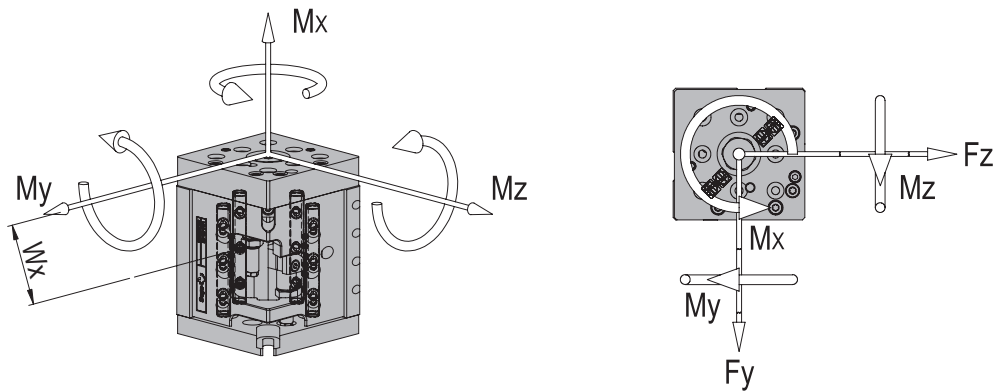

Operation time diagrams

Stroke times HM 10/10 extend vertically

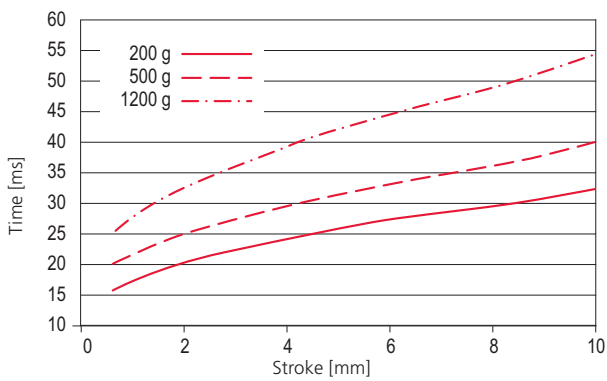

Stroke times HM 10/25 extend vertically

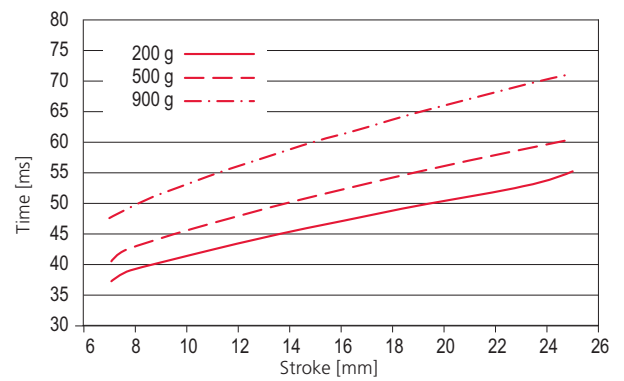

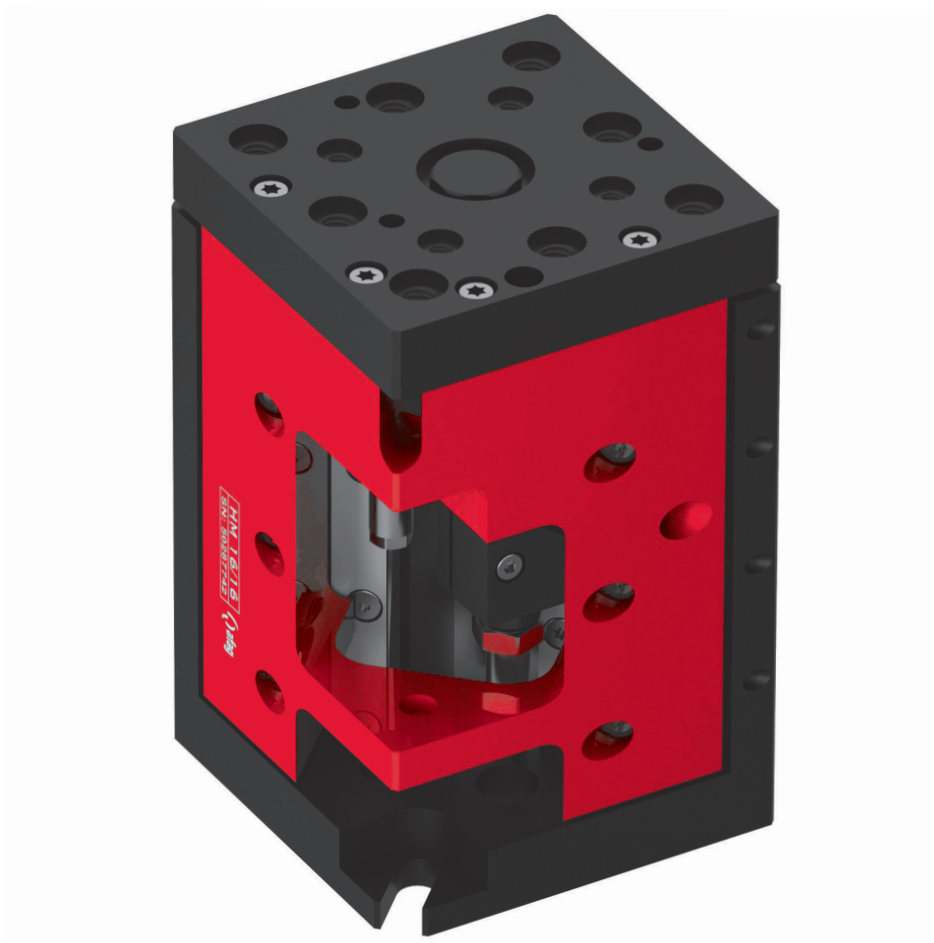

Lifting modules HM

HM 16

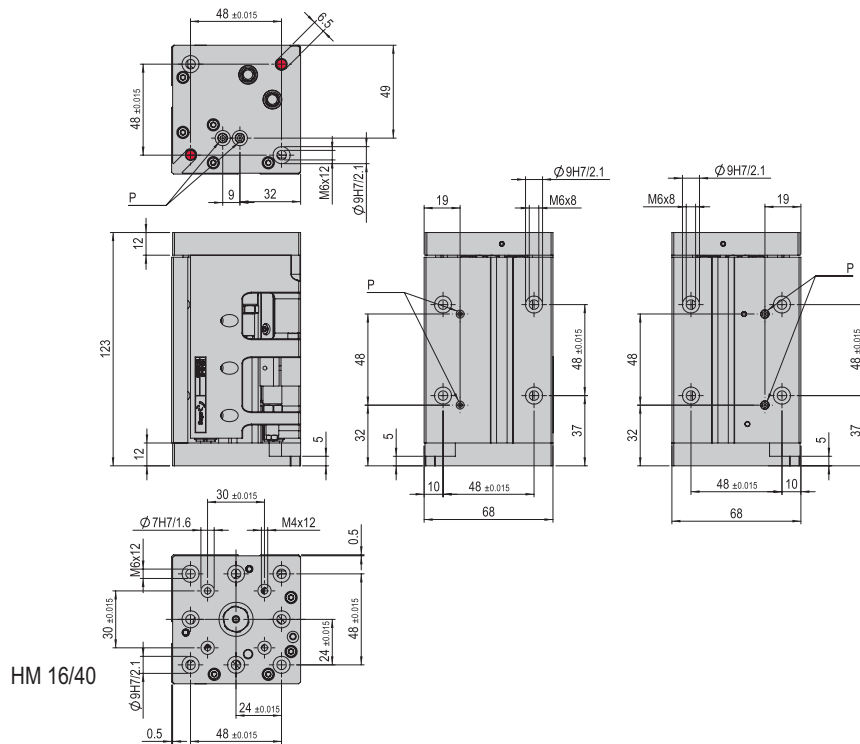
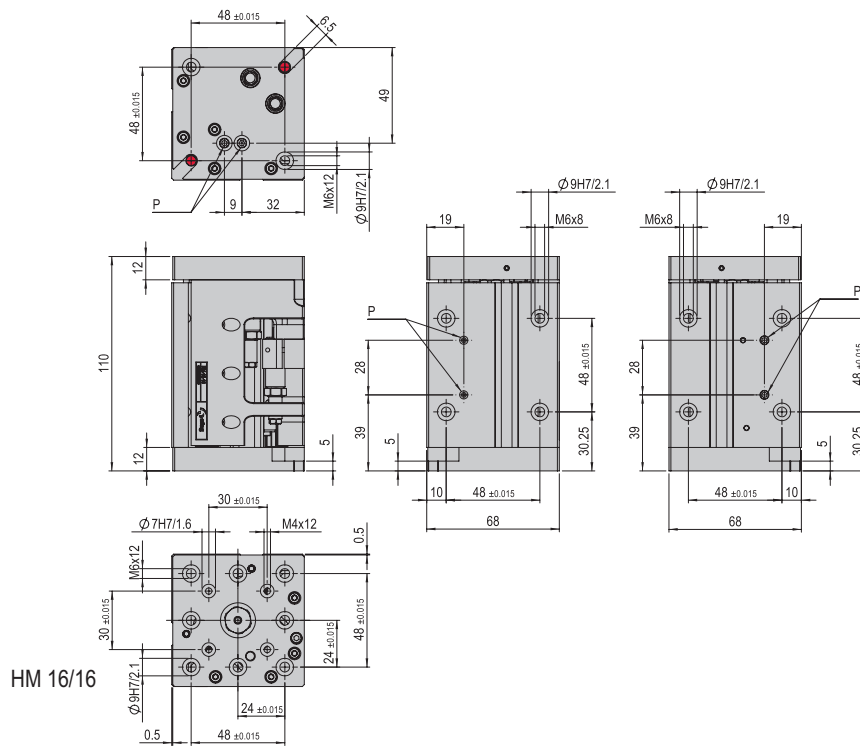

- Torsion-resistant
- Short build
- Simple table installation



 Bores can be screwed through

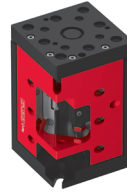

HM 16	
Attachment grid	30 x 30 mm
Attachment grid alternative	48 x 48 mm
Attachment thread	M4
Attachment thread alternative	M6
Operating pressure	6 +/- 2 bar
Air connection P	M5
Cylinder Ø	16 mm
Retract piston force	103 N
Extend piston force	120 N
Operating temperature	0 - 50 °C
Storage temperature	0 - 50 °C
Humidity	< 90 %
Medium filtered compressed air	10 - 40 µm

Type	HM 16/16	HM 16/40
Order number	50287742	50287743
Stroke H	16 mm	40 mm
Net weight	1.208 kg	1.321 kg
Max. payload	4 kg	3 kg
Air consumption/cycle	0.028 NL	0.069 NL
Noise level	< 65 dB (A)	< 65 dB (A)
Repeat accuracy	+/- 0.01 mm	+/- 0.01 mm
Load balance (LA)	30 N	25 N
Mounting position	✦	✦

The technical data refer to a nominal pressure of 6 bar under Afag standard test conditions.
 Note: The load balance supports the extension stroke and damps the retraction stroke.
 The module can be operated with lubricated or dry air.
 Cleanroom class ISO 14644-1, class ISO 7

Included in the delivery

(Catalogue HT accessories)

- 2x Centering bushing Ø9x4
- 2x Mounting screw M6x16
- 2x Washer M6
- 2x Stop sleeve ASH M10x1 -2
- 2x Shock absorber SD M8x1 -5

Accessories

(Catalogue HT accessories)

- INI c10x19.5-Em-PNP-NO-M8x1
- INI c10x28.5-Em-PNP-NO-M8x1

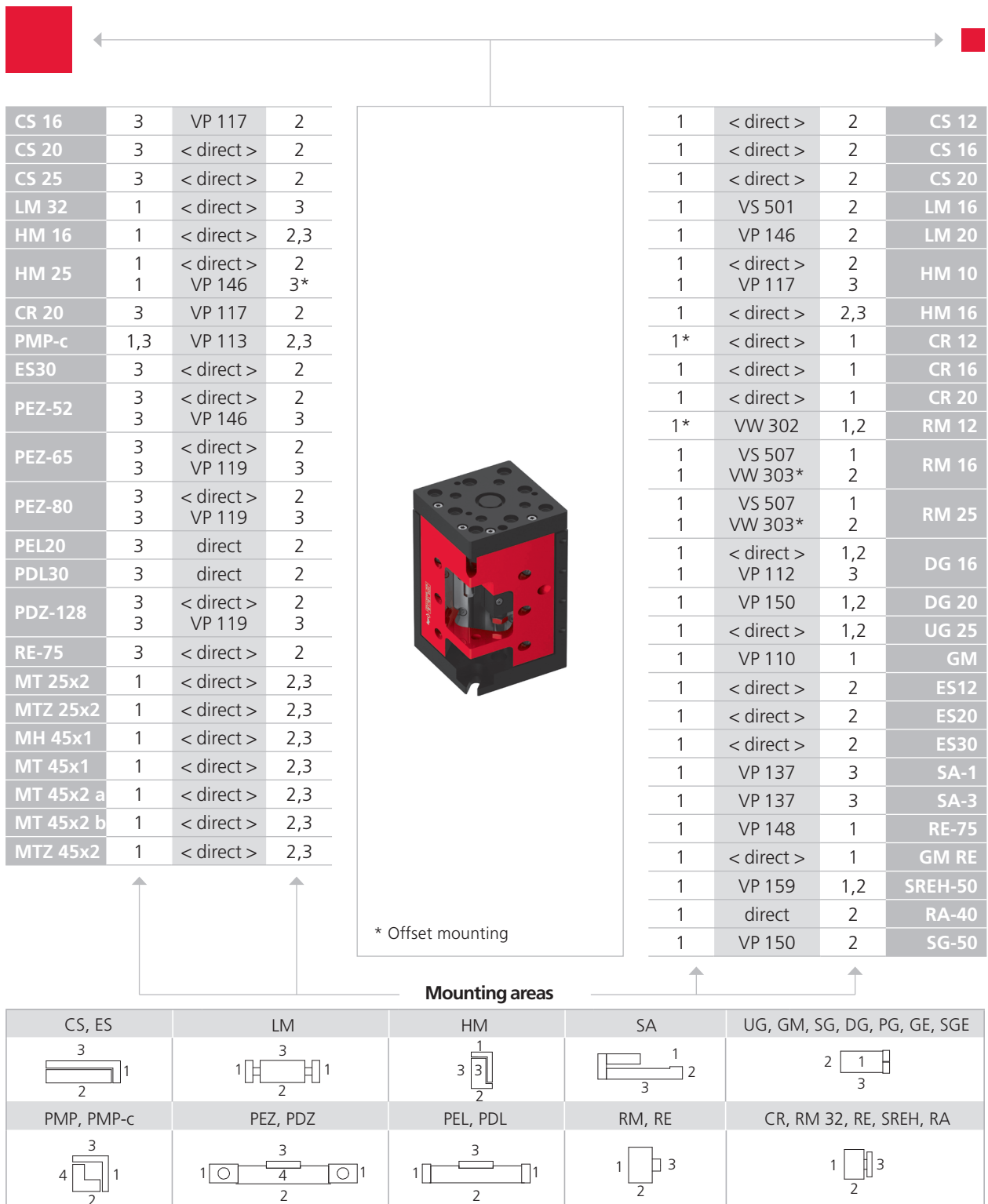

Note that there might be different mounting positions from one module to another one.
The required connection elements and the range of support columns are depicted in the catalogue HT accessories.

Type	HM 16/16	HM 16/40
Max. static torque M_x	30 Nm	30 Nm
Max. static torque M_y	20 Nm	22 Nm
Max. static torque M_z	20 Nm	22 Nm
Max. effective force F_y	380 N	420 N
Max. effective force F_z	380 N	420 N
Effective distance W_x	51.5 mm	51 mm

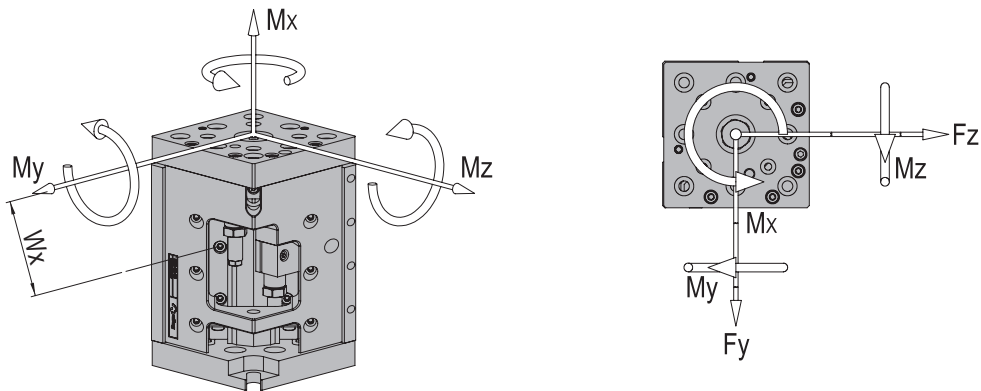

Operation time diagrams

Stroke times HM 16/16 extend vertically

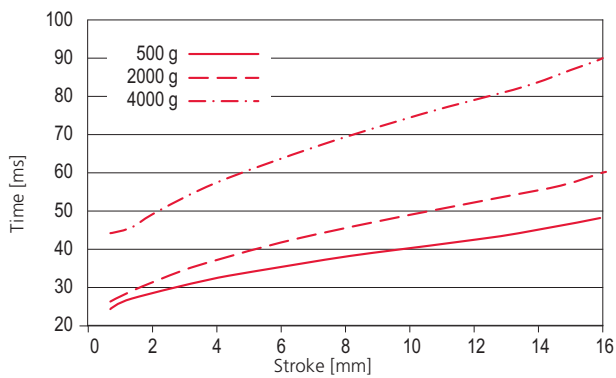

Stroke times HM 16/40 extend vertically

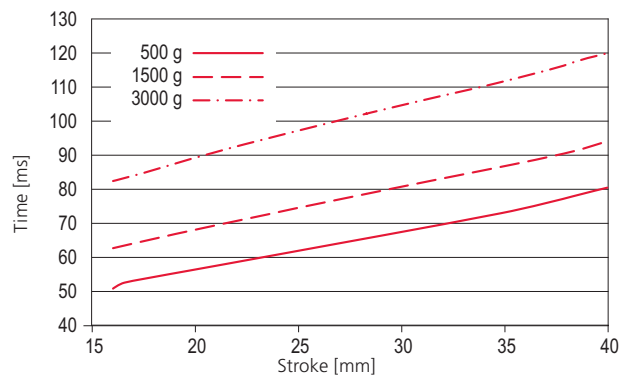

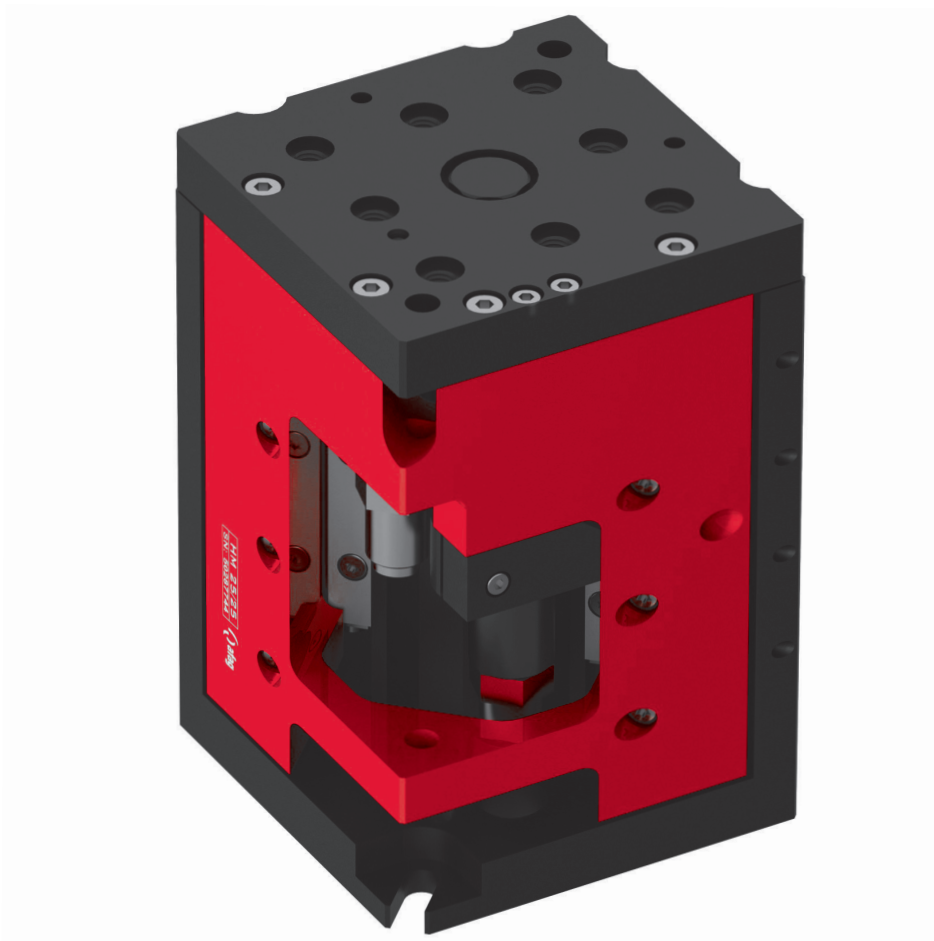

Lifting modules HM

HM 25

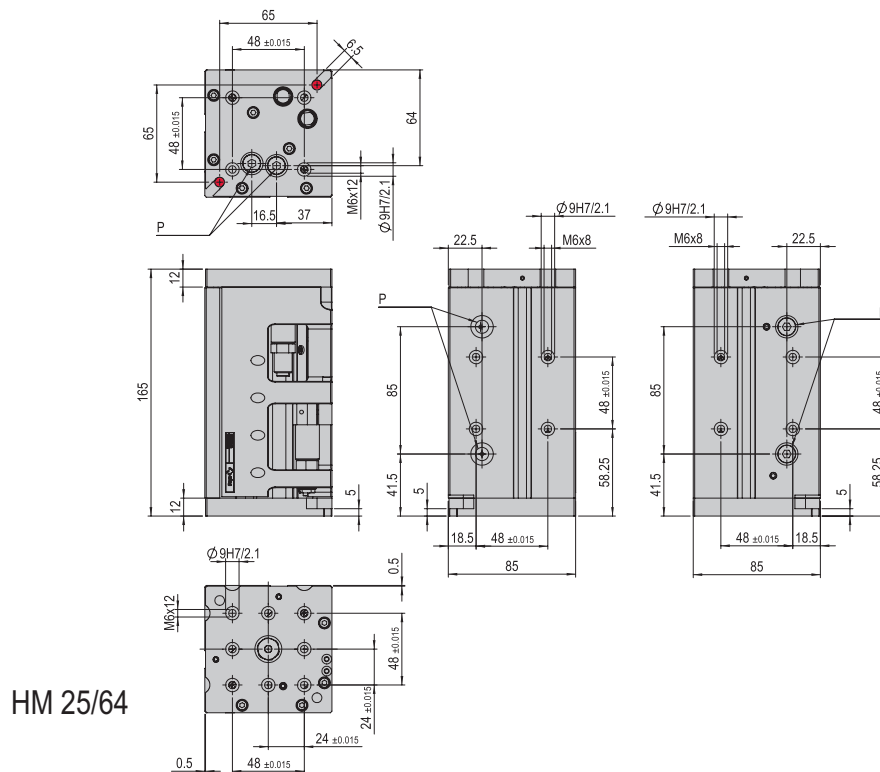
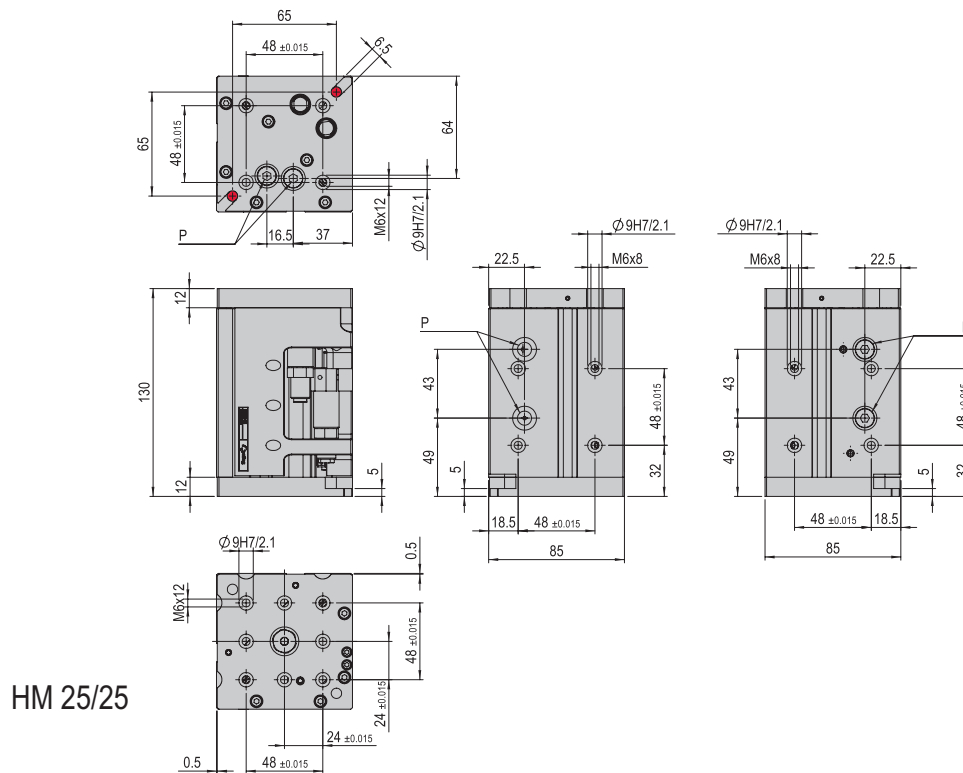

- Torsion-resistant
- Short build
- Simple table installation



 Bores can be screwed through

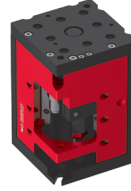

HM 25	
Attachment grid	48 x 48 mm
Attachment thread	M6
Operating pressure	6 +/- 2 bar
Air connection P	G 1/8 "
Cylinder Ø	25 mm
Retract piston force	247 N
Extend piston force	295 N
Operating temperature	0 - 50 °C
Storage temperature	0 - 50 °C
Humidity	< 90 %
Medium filtered compressed air	10 - 40 µm

Type	HM 25/25	HM 25/64
Order number	50287744	50287745
Stroke H	25 mm	64 mm
Net weight	2.168 kg	2.661 kg
Max. payload	10 kg	9 kg
Air consumption/cycle	0.104 NL	0.266 NL
Noise level	< 65 dB (A)	< 65 dB (A)
Repeat accuracy	+/- 0.01 mm	+/- 0.01 mm
Load balance (LA)	70 N	70 N
Mounting position	✦	✦

The technical data refer to a nominal pressure of 6 bar under Afag standard test conditions.
 Note: The load balance supports the extension stroke and damps the retraction stroke.
 The module can be operated with lubricated or dry air.
 Cleanroom class ISO 14644-1, class ISO 7

Included in the delivery (Catalogue HT accessories)

- 2x Centering bushing Ø9x4
- 2x Mounting screw M6x16
- 2x Stop sleeve ASH M16x1 -1
- 2x Washer M6
- 2x Shock absorber SD M12x1 -1

Accessories (Catalogue HT accessories)

- INI c10x28.5-Em-PNP-NO-M8x1

Alternative accessories (Catalogue HT accessories)

- INI c10x19.5-Em-PNP-NO-M8x1

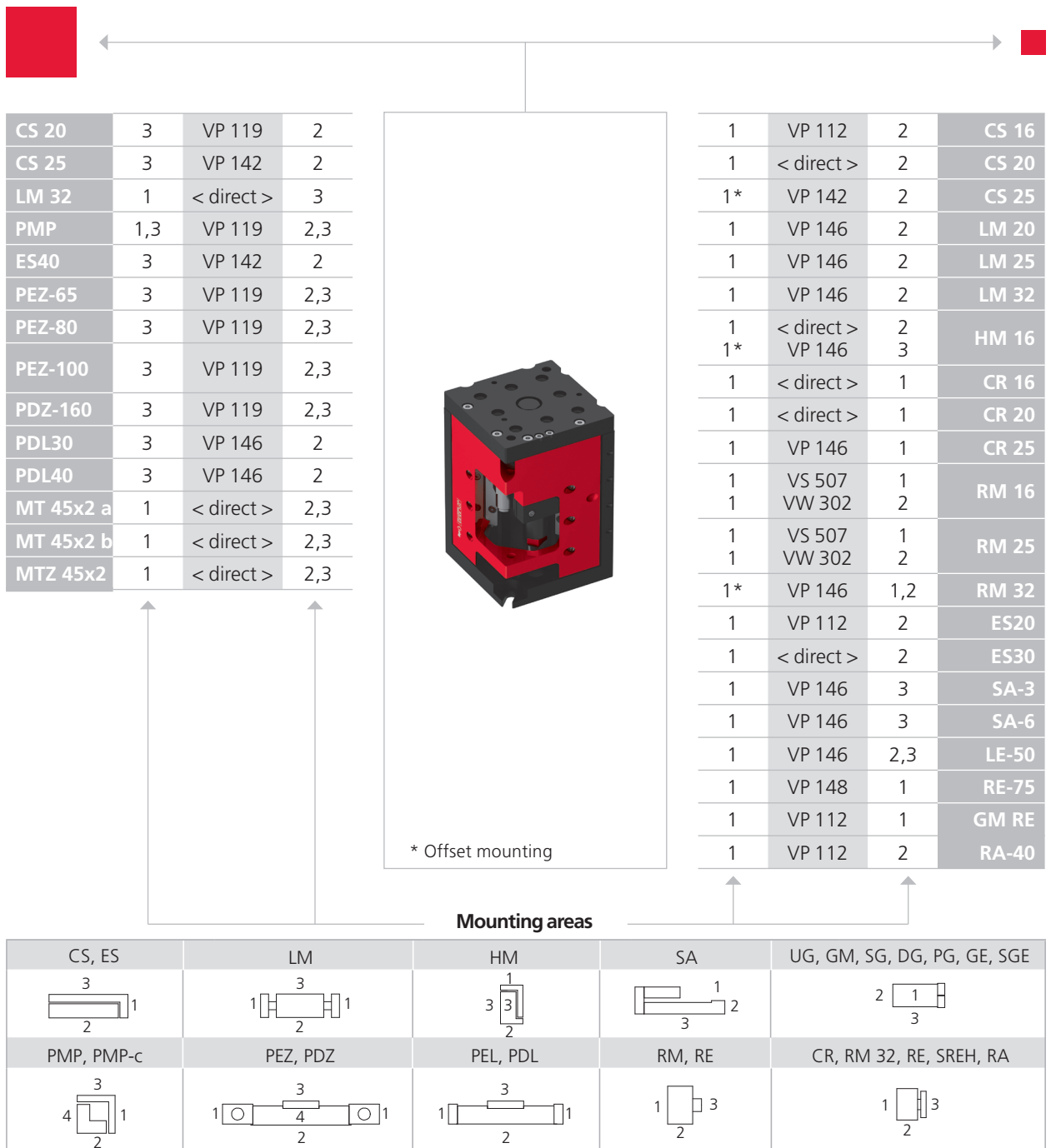

Note that there might be different mounting positions from one module to another one.

The required connection elements and the range of support columns are depicted in the catalogue HT accessories.

Type	HM 25/25	HM 25/64
Max. static torque M_x	50 Nm	56 Nm
Max. static torque M_y	25 Nm	27 Nm
Max. static torque M_z	25 Nm	27 Nm
Max. effective force F_y	410 N	400 N
Max. effective force F_z	410 N	400 N
Effective distance W_x	60 mm	66.5 mm

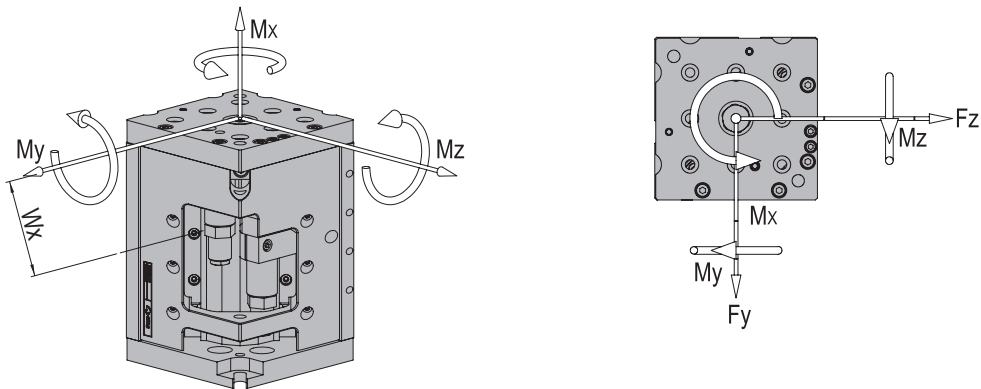

Operation time diagrams

Stroke times HM 25/25 extend vertically

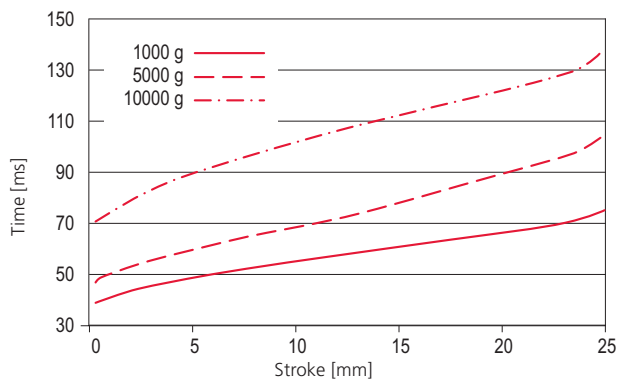

Stroke times HM 25/64 extend vertically

