

ASCO™ Solenoid Valves

single/dual solenoid (mono/bistable function) - pilot operated
aluminium body - 1/4" and 1/2" tapped

5/2 - 5/3
SERIES
551 - 553

Features

- The monostable spool valves in conformity with IEC 61508 Standard (2010 route 2_H version) have TÜV (551 series) and EXIDA (551-553 series) certified with integrity levels: SIL 2 for HFT = 0 / SIL 3 for HFT = 1
- The spool valves 5/2 and 5/3 have threaded port connections
- All the exhaust ports of the spool valve are connectable, providing better environmental protection. Particularly recommended for sensitive areas, such as clean rooms, and applications in the pharmaceutical and food processing sectors
- The valves offer environmental protection against the ingress of liquids, dusts or other foreign matter (environmentally-protected construction)
- Can be externally piloted (external air pilot supply) to convert valve to zero minimum operation by flipping a gasket
- The solenoid valves satisfy all relevant EU directives

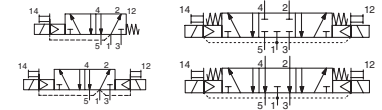

General

Differential pressure 2 - 10,4 bar [1 bar = 100 kPa]
Flow (Qv at 6 bar) 1/4" = 860 l/min (5/2) ; 760 l/min (5/3) (ANR)
1/2" = 3800 l/min (5/2, 5/3)

Fluids (*)	Temperature range (TS)	Seal materials (*)
air, inert gas, filtered	-25°C to +60°C	NBR (nitrile) + PUR (polyurethane)



Materials in contact with fluid

(*) Ensure that compatibility of materials in contact with fluids is verified.

Body	Aluminium, black anodised
End cover (spring return)	Glass-filled PA
Spool valve internal parts	Zamak, stainless steel, POM, aluminium
Pilot internal parts	Refer to specific solenoid catalogue pages
Pilot end covers	Aluminium
Core tube	Stainless steel
Core and plugnut	Stainless steel
Core spring	Stainless steel
Seals	NBR
Top disc	PA
Disc holder	POM
Cartridge (low power)	Welded, stainless steel or aluminium
Seat	Brass
Seat insert	POM
Shading coil	Copper
Rider rings (low power)	PTFE (NF/WSNF solenoids only)

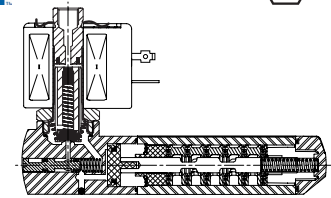

5/2 function, monostable

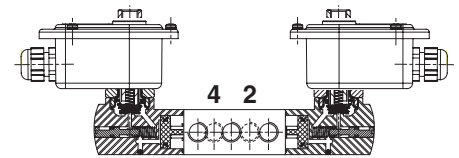

5/3 function

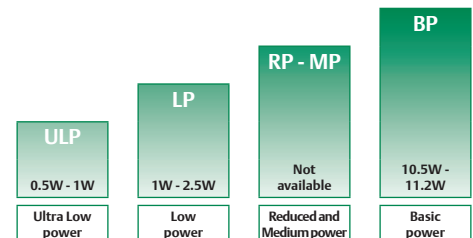

POWER LEVELS - cold electrical holding values (watt)

Specifications

Pipe size	Orifice size	Flow coefficient Kv		Operating pressure differential (bar)			Power level	Prefix optional solenoids							Basic catalogue number	
								Min. ⁽¹⁾	Max. (PS)		ATEX / IECEx					IP65
									Air (*)		NEMA	Ex db		Ex mb		
(*)	(mm)	(m ³ /h)	(l/min)	~	=	~/=	EF ⁽²⁾	LPKF	NF	EM	PV	LI	WSLI	SC		
5/2 - Solenoid air pilot operated - spring return (monostable)																
1/4"	6	0.75	12.5	0/2	10	10	BP	-	-	●	●	●	-	-	●	❖551B417 ⁽³⁾
							BP	●	-	-	-	-	-	-	-	❖551G417 ⁽³⁾
							LP	-	●	●	●	○	-	-	●	❖551B317 ⁽³⁾
							LP	○	-	-	-	-	-	-	-	❖551G317 ⁽³⁾
							ULP	-	○	-	-	-	-	○	○	-
1/2"	13	3.15	52.5	0/2	10	10	BP	-	-	●	●	●	-	-	●	❖553A417 ⁽³⁾
							BP	●	-	-	-	-	-	-	-	❖553G417 ⁽³⁾
							LP	-	●	●	●	○	○	○	●	❖553A317 ⁽³⁾
							LP	○	-	-	-	-	-	-	-	❖553G317 ⁽³⁾
							ULP	-	○	-	-	-	-	○	○	-
ULP	○	-	-	-	-	-	-	-	-	❖553H317 ⁽³⁾						

❖ Select 8 for NPT ANSI 1.20.3 or select G for ISO G (228/1) ● Available feature ○ Available feature in DC only. - Not available

⁽¹⁾ Zero minimum is only achieved if external pressure is applied.

⁽²⁾ UL CSA

⁽³⁾ Certified IEC 61508 Functional Safety data, use suffix "SL".

5/2 - 5/3
SERIES
551 - 553

Specifications

Pipe size	Orifice size	Flow coefficient Kv		Operating pressure differential (bar)			Power level	Prefix optional solenoids								Basic catalogue number	
								Min. ⁽¹⁾	Max. (PS)		NEMA	ATEX / IECEx					IP65
				~	=	7 & 9			Ex db	Ex emb		Ex mb	Ex ia	SC			
(*)	(mm)	(m ³ /h)	(l/min)				~/=	EF ⁽²⁾	LPKF	NF	EM	PV	LI	WSLI	SC		
5/2 - Solenoid air pilot operated and return (bistable)																	
1/4	6	0.75	12.5	0/2	10	10	BP	-	-	●	●	●	-	-	●	❖551B418	
							BP	●	-	-	-	-	-	-	-	-	❖551G418
							LP	-	-	●	●	○	-	-	●	❖551B318	
							LP	○	-	-	-	-	-	-	-	❖551G318	
							ULP	-	○	-	-	-	○	○	-	❖551B318	
							ULP	○	-	-	-	-	-	-	-	❖551H318	
1/2	13	3.15	52.5	0/2	10	10	BP	-	-	●	●	●	-	-	●	❖553A418	
							BP	●	-	-	-	-	-	-	-	❖553G418	
							LP	-	-	●	●	○	-	-	●	❖553A318	
							LP	○	-	-	-	-	-	-	-	❖553G318	
							ULP	-	○	-	-	-	○	○	-	❖553A318	
							ULP	○	-	-	-	-	-	-	-	❖553H318	
5/3 - W1 - pressure held, solenoid air pilot operated and return																	
1/4"	6	0.66	11	0/2	10	10	BP	-	-	●	●	●	-	-	●	❖551B467	
							LP	-	-	●	●	○	-	-	●	❖551B367	
							ULP	-	○	-	-	-	○	○	-	❖551B367	
1/2"	13	3.15	52.5	0/2	10	10	BP	-	-	●	●	●	-	-	●	❖553A467	
							LP	-	-	●	●	○	-	-	●	❖553A367	
							ULP	-	○	-	-	-	○	○	-	❖553A367	
5/3 - W3 - pressure release, solenoid air pilot operated and return																	
1/4"	6	0.66	11	0/2	10	10	BP	-	-	●	●	●	-	-	●	❖551B468	
							LP	-	-	●	●	○	-	-	●	❖551B368	
							ULP	-	○	-	-	-	○	○	-	❖551B368	
1/2"	13	3.15	52.5	0/2	10	10	BP	-	-	●	●	●	-	-	●	❖553A468	
							LP	-	-	●	●	○	-	-	●	❖553A368	
							ULP	-	○	-	-	-	○	○	-	❖553A368	

❖ Select 8 for NPT ANSI 1.20.3 or select G for ISO G (228/1) ● Available feature ○ Available feature in DC only. - Not available

⁽¹⁾ Zero minimum is only achieved if external pressure is applied.

⁽²⁾ UL CSA

Prefix table

Prefix							Description	Power level			
1	2	3	4	5	6	7		ULP	LP	MP	BP
E	F						Explosionproof - NEMA 7, 9 - Zinc plated steel conduit (18" continuous leads)	○	○	-	●
E	F	H	T				EF (18" continuous leads) + high temperature	○	○	-	●
E	F	H	T	L			EF + high temperature + 72" continuous leads	○	○	-	●
E	F	L					EF + 72" continuous leads	○	○	-	●
J	B	E	F				EF + Junction box (conduit in 1/2" NPT)	○	○	-	●
J	B	E	F	M	F		EF + Junction box (conduit in 1/2" NPT) + surge suppression coils	○	○	-	●
J	C	E	F				EF + Junction box (conduit in 3/4" NPT)	○	○	-	●
J	C	E	F	H	T		EF + Junction box (conduit in 3/4" NPT) + high temperature	○	○	-	●
E	M						Waterproof IP66/67 - Metal enclosure (EN/IEC 60079-7,-18 and -31)*	-	○	-	●
		E	T				Threaded conduit/hole (M20 x 1.5)	-	●	-	●
L	P	K	F				Flameproof - Aluminium (EN/IEC 60079-1, 60079-31)*	○	●	-	-
N	F						Flameproof - Aluminium (EN/IEC 60079-1, 60079-31)*	-	●	-	●
P	V						Encapsulated epoxy moulded (EN/IEC 60079-18)*	-	○	-	●
S	C						Solenoid with spade plug connector (EN/IEC 60730)	-	●	-	●
W	P						Waterproof IP67 - Metal enclosure	-	●	-	●
L	I						I.S. with Aluminium IP66/IP67 enclosure (EN/IEC 60079-11+31)*	○	-	-	-
W	S						Waterproof IP67 - 316 SS enclosure	-	●	-	●
W	S	L	P	K	F		Flameproof 316L SS (EN/IEC 60079-1, 60079-31)*	○	●	-	-
W	S	E	M				Waterproof IP66/67 - 316 SS enclosure (EN/IEC 60079-0+7+18+31)*	-	●	-	●
W	S			L	I		I.S. with 316L SS IP66/IP67 enclosure (EN/IEC 60079-11+31)*	○	-	-	-
W	S	N	F				Flameproof 316L SS (EN/IEC 60079-1, 60079-31)*	-	●	-	●
		T					Threaded conduit (1/2" NPT)	-	●	-	●
				H	T		Class H - High temperature, +80°C ambient temp.	-	-	-	●
						X	Other special constructions	-	●	-	●

Product selection guide

STEP 1

Select basic catalogue number, including pipe thread identification letter. Refer to the specifications table on page: 1 or 2

Example: G551A417

STEP 2

Select prefix (combination). Refer to the specifications table and the prefix table, respect the indicated power level.

Example: EM

STEP 3

Select suffix (combination) if required. Refer to the suffix table, respect the indicated power level.

Example: MO

STEP 4

Select voltage. Refer to standard voltages on page: 4

Example: 230V / 50Hz

STEP 5

Final catalogue / ordering number.

Example:

EM G551A417MO 230 V / 50 Hz

Suffix table

Suffix							Description	Power level			
1	2	3	4	5	6	7		ULP	LP	MP	BP
			M	O			Push type manual operator	○	○/●	-	●
S	L						Certified IEC 61508 Functional Safety data ⁽¹⁾	○	○/●	-	●

Options and Accessories

Series	Pipe size	Exhaust protector (stainless steel)		
		G	NPT	(M)
551-553	1/8"	34600418 ⁽²⁾	34600482 ⁽²⁾	-
551	1/4"	34600419 ⁽²⁾	34600483 ⁽²⁾	-
553	1/2"	34600479 ⁽²⁾	34600479 ⁽²⁾	-
551	M5	-	-	34600484 ⁽²⁾

● Available feature

○ Available feature in DC only

- Not available

* ATEX/IECEx valves using these solenoids are approved according to EN ISO 80079-36 (2016) and EN ISO 80079-37 (2016) [non electrical]

⁽¹⁾ Not to use with MO suffix

⁽²⁾ Provided with "SL" suffix

Ordering examples valves:

SC	G	551	B	417	230V / 50 Hz
SC	G	551	B	417	SL 230V / 50 Hz
SC	G	551	B	418	MO 230V / 50 Hz
SCHT	8	551	B	418	MO 230V / 50 Hz
LPKF	G	551	B	317	MO 24V / DC
LPKF	G	551	B	317	MO 230V / 50 Hz
WSLPKF	G	551	B	317	MO 24V / DC
LI	G	553	A	317	24V / DC
EM	8	553	A	418	MO 230V / 50 Hz
EF	G	551	G	417	MO 240V / 60 Hz

prefix — pipe thread — basic number — voltage — suffix

Explanation of temperature ranges of solenoid valves

Valve temperature range	The valve temperature range (TS) is determined by the selected seal material, the temperature range for proper operation of the valve and sometimes by the fluid (e.g. steam)
Operator ambient temperature range	The operator ambient temperature range is determined by the selected power level and the safety code
Total temperature range	The temperature range of the complete solenoid valve is determined by the limitations of both temperature ranges above

Electrical characteristics

Coil insulation class	F
Electrical safety	IEC 335
Standard voltages	DC (=) 24V - 48V AC (~) 24V - 48V - 115V - 230V ⁽¹⁾ /50Hz; other voltages and 60Hz are available on request

Prefix option	Power ratings			Operator ambient temperature range (TS) (C°) ⁽²⁾	Safety code	Electrical enclosure protection (EN 60529)	Replacement coil / Kit		Type ⁽³⁾	
	Inrush	Holding	Hot/Cold				~	=		
	(VA)	(VA)	(W)				230 V/50 Hz	24V/DC		
Basic power (BP)										
SC	55	23	10.5	9/11.2	-40 to +75	EN 60730	IP65, moulded	400425-117	400425-142	01
WP/WS	55	23	10.5	9/11.2	-40 to +75	EN 60730	IP67, steel /SS	400405-117	400405-142	03
NF/WSNF	55	23	10.5	-	-60 to +25/40/60	II2G Ex db IIC Gb T6/T5/T4, II2D Ex tb IIIC Db	IP66/67, alu./SS	400405-117	-	02
NF/WSNF	-	-	-	9/11.2	-60 to +40/60/75	II2G Ex db IIC Gb T6/T5/T4, II2D Ex tb IIIC Db	IP66/67, alu./SS	-	400405-142	02
EM/WSEM	55	23	10.5	9/11.2	-40 to +40	II2G Ex eb mb IIC Gb T3, II2D Ex tb IIIC Db	IP66/67, steel /SS	400909-117	400913-142	03
PV	55	23	10.5	9/11.2	-40 to +65	II2G Ex mb IIC Gb T3(~)/T4(=), II2D Ex mb IIIC Db	IP67, moulded	- ⁽⁴⁾	- ⁽⁴⁾	04
EF	55	23	10.5	9/11.2	-40 to +52/40	NEMA type 7 and 9	NEMA 4X	-	-	05
EFHT	55	23	10.5	9/11.2	-40 to +52/40	NEMA type 7 and 9	NEMA 4X	-	-	05
JBEF	55	23	10.5	9/11.2	-40 to +52/40	NEMA type 7 and 9	NEMA 4X	-	-	11
JBEFHT	55	23	10.5	9/11.2	-40 to +52/40	NEMA type 7 and 9	NEMA 4X	-	-	11
Low Power (LP)										
SC	1.5	1.5	1.5	1.7/1.7	-40 to +60	EN 60730	IP65, moulded	400925-097	400925-042	06
WP/WS	1.5	1.5	1.5	1.7/1.7	-40 to +60	EN 60730	IP67, steel /SS	400926-097	400926-042	08
LPKF/WSLPKF	2.4	2.4	2.4	-	-40 to +40/65/80	II2G Ex db IIB+H2 Gb T6/T5/T4, II2D Ex tb IIIC Db	IP66/67, alu./SS	- ⁽⁴⁾	- ⁽⁴⁾	12
LPKF/WSLPKF	-	-	-	2.1 ⁽⁵⁾	-40 to +40/80	II2G Ex db IIB+H2 Gb T6/T5/T4, II2D Ex tb IIIC Db	IP66/67, alu./SS	- ⁽⁴⁾	- ⁽⁴⁾	12
NF/WSNF	1.85	1.85	1.85	1.5/1.8	-60 to +75/80	II2G Ex db IIC Gb T6/T5, II2D Ex tb IIIC Db	IP66/67, alu./SS	- ⁽⁴⁾⁽¹⁾	- ⁽⁴⁾	07
EM/WSEM	1.5	1.5	1.5	1.7/1.7	-40 to +40/55	II2G Ex eb mb IIC Gb T6/T5, II2D Ex tb IIIC Db	IP66/67, steel /SS	- ⁽⁴⁾	- ⁽⁴⁾	08
PV	-	-	-	1.7/1.7	-40 to +65	II2G Ex mb IIC Gb T6, II2D Ex mb IIIC Db	IP67, moulded	-	- ⁽⁴⁾	09
EF	-	-	-	1.8/1.8	-40 to +60	NEMA type 7 and 9	NEMA 4X	-	-	10
EFHT	-	-	-	1.8/1.8	-40 to +60	NEMA type 7 and 9	NEMA 4X	-	-	10
JBEF	-	-	-	1.8/1.8	-40 to +60	NEMA type 7 and 9	NEMA 4X	-	-	11
JBEFHT	-	-	-	1.8/1.8	-40 to +60	NEMA type 7 and 9	NEMA 4X	-	-	11
Ultra Low Power (ULP)										
LPKF/WSLPKF	-	-	-	0.5/0.5 ⁽⁵⁾	-40 to +70/80	II2G Ex db IIB+H2 Gb T6/T5, II2D Ex tb IIIC Db	IP66/67, alu./SS	-	- ⁽⁴⁾	12
EF	-	-	-	0.55/0.7	-40 to +52/40	NEMA type 7 and 9	NEMA 4X	-	-	10
EFHT	-	-	-	0.55/0.7	-40 to +52/40	NEMA type 7 and 9	NEMA 4X	-	-	10
JBEF	-	-	-	0.55/0.7	-40 to +52/40	NEMA type 7 and 9	NEMA 4X	-	-	11
JBEFHT	-	-	-	0.55/0.7	-40 to +52/40	NEMA type 7 and 9	NEMA 4X	-	-	11
LI ⁽⁶⁾⁽⁷⁾	-	-	-	0.5/0.5	-40 to +60	II1G Ex ia IIC T6 Ga, II2D Ex tb IIIC Db ⁽⁷⁾	IP66/67, alu.	-	- ⁽⁴⁾	13
WSLI ⁽⁶⁾⁽⁷⁾	-	-	-	0.5/0.5	-40 to +60	II1G Ex ia IIC T6 Ga, II2D Ex tb IIIC Db ⁽⁷⁾	IP66/67, SS	-	- ⁽⁴⁾	13

Prefix option	Safety parameters				
	U _i = (DC)	I _i	P _i	L _i	C _i
	(V)	(mA)	(W)	(H)	(µF)
Ultra Low Power (ULP)					
LI/WSLI	32	500	1.5	0	0

⁽¹⁾ (WS)NF: Low Power, 230 V AC does not exist. Maximum voltage in AC is 115 V

⁽²⁾ Temperature range can be limited by sealings

⁽³⁾ Refer to the dimensional drawings on pages: 5 to 8

⁽⁴⁾ Multiple coil kits are available under ATEX/IECEx, contact us

⁽⁵⁾ LPKF/WSLPKF: 24 V DC (0,5 W)

⁽⁶⁾ LI/WSLI: Check the electrical characteristics in the corresponding catalogue pages

⁽⁷⁾ LI/WSLI: Ultra Low Power, 24 V DC only (LI: **For use in zone 0 locations, see the installation conditions given in the I&M instructions**)

- Not available

Electrical connections

Prefix	Connection
SC	Spade plug connector with cable gland EN175301-803A (ISO 4400) for cables with an outer diameter from 6 to 10 mm
WP, WS, EM, WSEM	M20 plastics cable gland for cables with an outer diameter from 7 to 12 mm.
NF, WSNF, LPKF, WSLPKF	1/2" NPT threaded cable entry. Enclosures are supplied without cable gland
PV	Moulded-in cable, standard length 2 m
LI, WSLI	1/2" NPT threaded cable entry. Enclosures are supplied without cable gland
EF	1/2" NPT conduits
JBEF	EF + Junction box

Additional options

- Valves configured for external pilot air supply, TPL 20547
- Other pipe threads are available on request
- Ex mb (prefix "PV") solenoid can be supplied with various cable lengths

Installation

- Multi language installation/maintenance instructions are included with each valve
- The solenoid valves can be mounted in any position without affecting operation
- Do not connect the pressure supply to the exhaust port 3. The "environmentally-protected" construction is not adapted for a "distributing" function or use in NO function. Contact us for functions available in specific versions
- IEC 61508 Functional Safety (suffix SL). Check temperature range of valve body and solenoid for suitability. For probability of failure, contact us
- It is necessary to connect pipes or fittings to the exhaust ports to protect the internal parts of the spool valve and its pneumatic operator if used outside or in harsh environments (dusts, liquids etc.)
- Threaded pipe connection identifier is 8 = NPT (ANSI 1.20.3); G = G (ISO 228/1)
- Ex db Prefix "NF/WSNF" enclosure is provided with a 1/2" NPT threaded entry hole, M20 x 1,5 (prefix "ET") is optional. These are supplied without cable gland

Dimensions (mm), Weight (kg)

551 Series

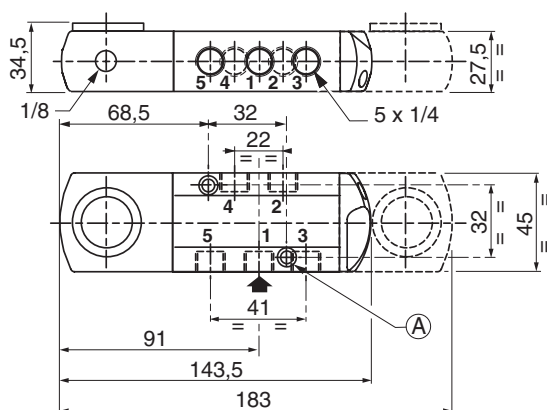

553 Series

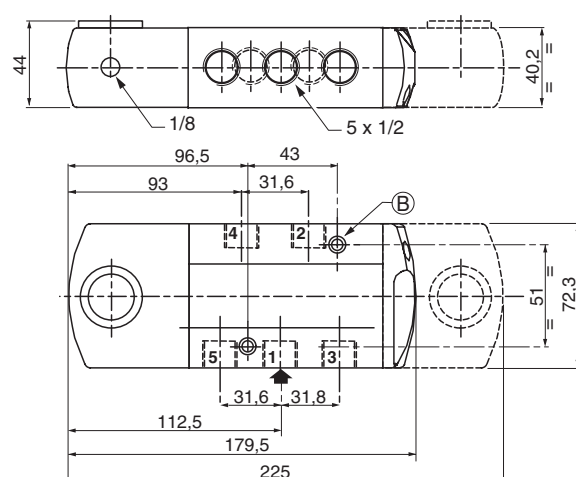

(A) 2 mounting holes: 5.3 mm dia.; Spotfacing: 9 mm dia., depth 5 mm

(B) 2 mounting holes: 6.5 mm dia.; Spotfacing: 11 mm dia., depth 6 mm

5/2 - 5/3
SERIES
551 - 553

Dimensions (mm), Weight (kg) 



TYPE 01:
Epoxy moulded
SC: IEC 335 / ISO 4400

551B417/B418/B417MO/B418MO/B467/B468/B467MO/B468MO
553A417/A418/A417MO/A418MO/A467/A468/A467MO/A468MO

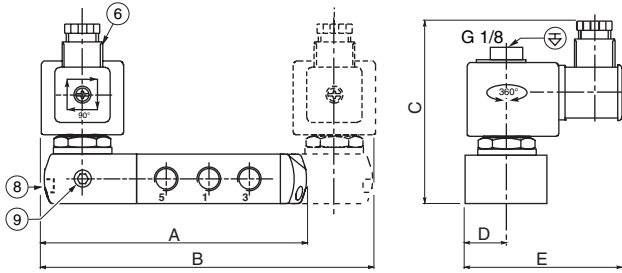

TYPE 02:
Aluminium, epoxy coated / AISI 316L SS
NF / WSNF: EN/IEC 60079-1, 60079-31

551B417/B418/B417MO/B418MO/B467/B468/B467MO/B468MO
553A417/A418/A417MO/A418MO/A467/A468/A467MO/A468MO

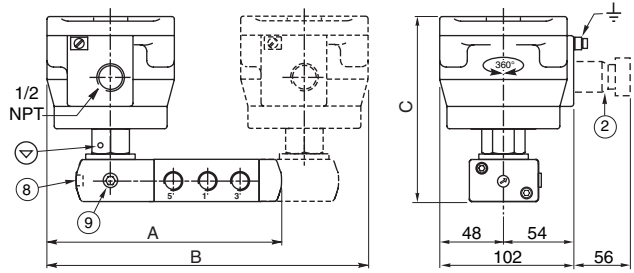

TYPE 03:
Metal, epoxy coated / AISI 316L SS
WP / WS: IEC 335
EM / WSEM: EN/IEC 60079-7+18+31

551B417/B418/B417MO/B418MO/B467/B468/B467MO/B468MO
553A417/A418/A417MO/A418MO/A467/A468/A467MO/A468MO

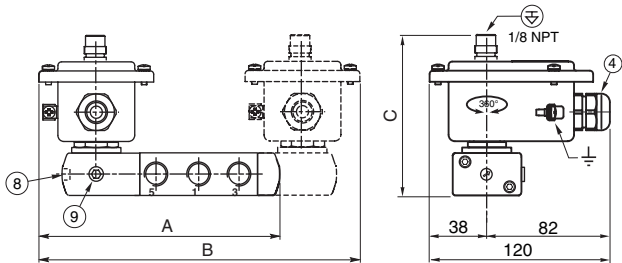

TYPE 04:
Epoxy encapsulated
PV: EN/IEC 60079-18

551B417/B418/B417MO/B418MO/B467/B468/B467MO/B468MO
553A417/A418/A417MO/A418MO/A467/A468/A467MO/A468MO

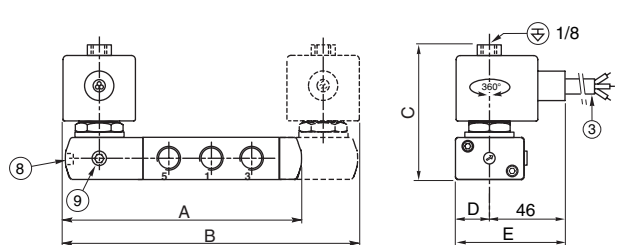

TYPE 05:
Epoxy encapsulated
EF: NEMA type 7, 9 / ICS-6 ANSI

551G417/G418/G417MO/G418MO/G467/G468/G467MO/G468MO
553G417/G418/G417MO/G418MO/G467/G468/G467MO/G468MO

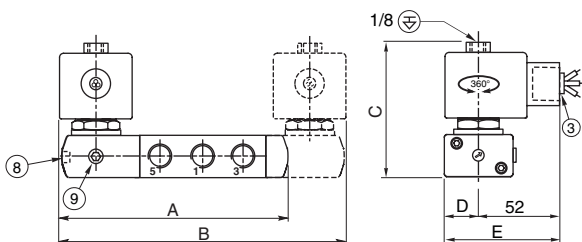

TYPE 06:
Epoxy moulded
SC: IEC 335 / ISO 4400

551B317/B318/B317MO/B318MO/B367/B368/B367MO/B368MO
553A317/A318/A317MO/A318MO/A367/A368/A367MO/A368MO

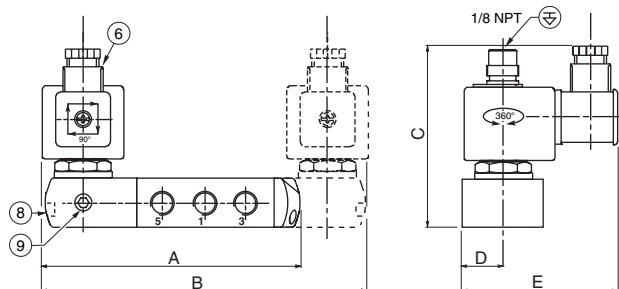

Dimensions (mm), Weight (kg) 



TYPE 07:
Aluminium, epoxy coated / AISI 316L SS
NF / WSNF: EN/IEC 60079-1, 60079-31

551B317/B318/B317MO/B318MO/B367/B368/B367MO/B368MO
553A317/A318/A317MO/A318MO/A367/A368/A367MO/A368MO

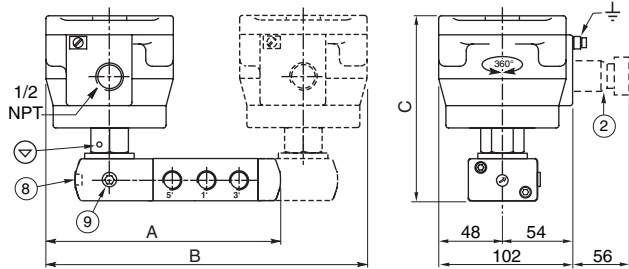

TYPE 08:
Metal, epoxy coated / AISI 316L SS
WP / WS: IEC 335
EM / WSEM: EN/IEC 60079-7+18+31

551B317/B318/B317MO/B318MO/B367/B368/B367MO/B368MO
553A317/A318/A317MO/A318MO/A367/A368/A367MO/A368MO

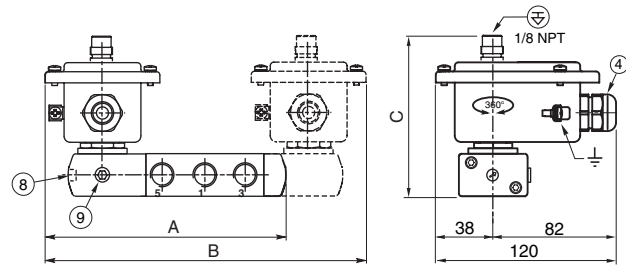

TYPE 09:
Epoxy encapsulated
PV: EN/IEC 60079-18

551B317/B318/B317MO/B318MO/B367/B368/B367MO/B368MO
553A317/A318/A317MO/A318MO/A367/A368/A367MO/A368MO

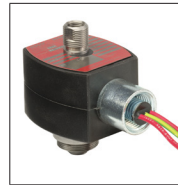
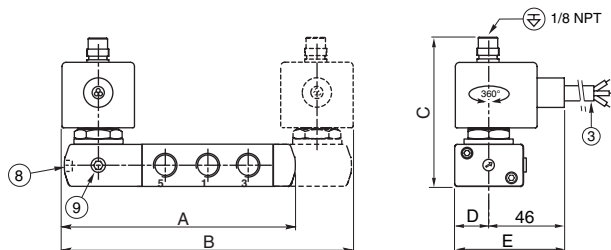

TYPE 10:
Epoxy encapsulated
EF: NEMA type 7, 9 / ICS-6 ANSI

551G317/H317/G318/H318/ G317MO/H317MO/G318MO/H318MO
553G317/H317/G318/H318/ G317MO/H317MO/G318MO/H318MO

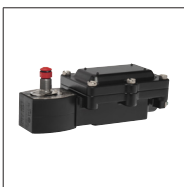
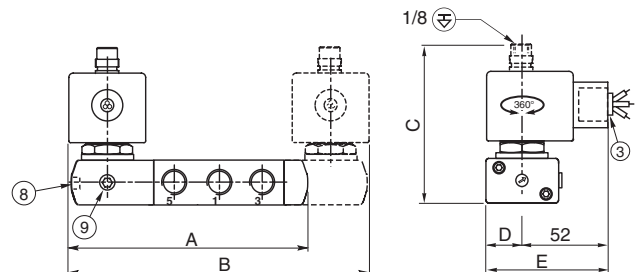

TYPE 11:
Epoxy encapsulated
JBEF: NEMA type 7, 9

551G317/H317/G318/H318/ G317MO/H317MO/G318MO/H318MO
553G317/H317/G318/H318/ G317MO/H317MO/G318MO/H318MO

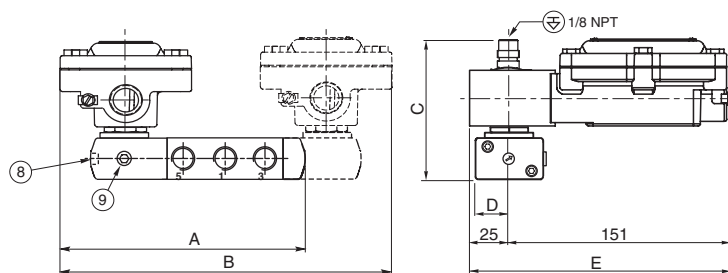

TYPE 12:
Aluminium, cataphoresis black painting / AISI 316L SS
LPKF/WSLPKF: EN/IEC 60079-1, 60079-31

551B317/B318/B317MO/B318MO/B367/B368/B367MO/B368MO
553A317/A318/A317MO/A318MO/A367/A368/A367MO/A368MO

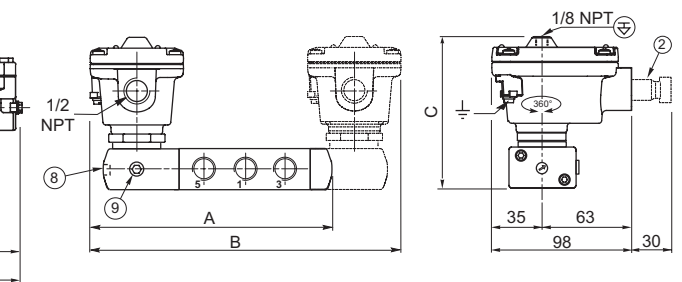

**5/2 - 5/3
SERIES
551 - 553**

Dimensions (mm), Weight (kg)



TYPE 13:
Aluminium, cataphoresis black painting / AISI 316L SS
LI / WSLI: EN/IEC 60079-11, 60079-31

551B317/B318/B317MO/B318MO/B367/B368/B367MO/B368MO
553A317/A318/A317MO/A318MO/A367/A368/A367MO/A368MO

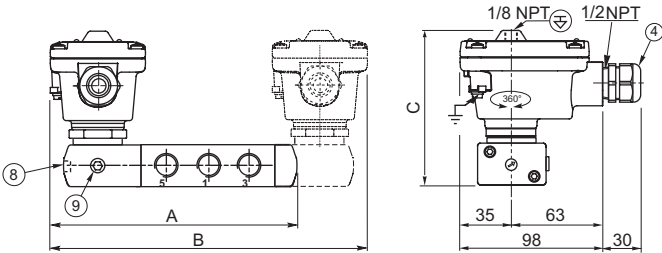

- ② Ex d certified cable gland (on request)
- ③ Three-core cable, length 2 m
- ④ Cable gland for unarmoured cable with 7 to 12 mm dia. sheath
- ⑥ Connector rotatable by 90° increments, cable Ø 6 - 10 mm
- ⑧ Manual operator location, suffix MO
- ⑨ External pilot air supply, 1/8" pipe size
- ⊕ Connectable pilot exhaust port
- ⊖ Non-connectable pilot exhaust port

Type	Prefix/Option	Power level	A		B		C		D		E		Weight ⁽¹⁾			
			551	553	551	553	551	553	551	553	551	553	Monostable		Bistable	
			551	553	551	553	551	553	551	553	551	553	551	553	551	553
01	SC	BP	144	179.5	182	225	102.7	112.2	22.5	36.15	86.5	100.2	0.79	1.50	1.37	2.06
02	NF / WSNF	BP	170	224.3	236	314.6	141.8	151.3	-	-	-	-	1.88	2.54	3.54	4.20
03	WP / WS	BP	160	196.2	216	253.3	103	112.5	-	-	-	-	0.87	1.51	1.52	2.08
03	(WS)EM	BP	160	196.2	216	253.3	103	112.5	-	-	-	-	0.87	1.51	1.52	2.08
04	PV	BP	144	179.5	184	225	88	97.5	22.5	36.15	67.5	81.2	0.85	1.51	1.48	2.07
05	EF	BP	144.5	183	185	232	85.5	95	22.5	36.15	74.5	88.2	0.67	1.51	1.32	2.08
06	SC	LP	144.5	180.5	185	227	101.5	111	22.5	36.15	87.5	101.2	1.00	1.71	1.58	2.27
07	NF / WSNF	LP	170	224.3	236	314.6	141.8	151.3	-	-	-	-	1.88	2.54	3.54	4.20
08	WP/WS/(WS)EM	LP	160	196.2	216	258.3	102.2	111.7	-	-	-	-	1.08	1.72	1.73	2.29
09	PV	LP	144	179.5	184	225	100.5	110	22.5	36.15	67.5	81.2	1.06	1.72	1.69	2.28
10	EF	LP	144.5	183	185	232	100.5	110	22.5	36.15	74.5	88.2	0.88	1.72	1.53	2.29
11	JBEF	BP / LP / ULP	165.5	200	230.5	267	100.5	110	22.5	36.15	176	187.16	1.32	1.84	2.44	2.88
12	LPKF	LP / ULP	153	191.5	204	249	113	122.5	-	-	-	-	0.93	1.91	1.65	2.36
12	WSLPKF	LP / ULP	153	191.5	204	249	113	122.5	-	-	-	-	1.54	2.92	2.85	3.43
13	LI	ULP	153	191.5	204	249	113	122.5	-	-	-	-	0.94	1.92	1.66	2.37
13	WSLI	ULP	153	191.5	204	249	113	122.5	-	-	-	-	1.55	2.53	2.86	3.57

⁽¹⁾ Incl. coil(s) and connector(s).

Accessories

Pilot exhaust protector
part number
276405-001

Pilot top exhaust low power
(ASCO solenoid interface)

ØA	M5	1/8	1/4	3/8	1/2
B	4.5	10	11	11	14

Exhaust protector
(stainless steel)

Availability, design and specifications are subject to change without notice. All rights reserved. 80088GB-2023/R01