

ASCO™ Solenoid Valves

Direct Operated, 1/8" or 1/4" tapped

3/2 NC-U-NO
Series 314

- Compact valve intended for single acting actuator control
- High operating speed
- Valve optimised for general 3-way piloting applications, only one spring and two moving parts
- RoHS compliance
- Valves do not require a minimum operating pressure
- Compliance with UL and CSA standards
- The solenoid valves satisfy all relevant EU directives

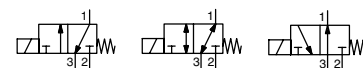

General

Differential pressure See «SPECIFICATIONS» [1 bar = 100 kPa]
Maximum viscosity 65 cSt (mm²/s)
Response time 5 - 25 ms

fluids (*)	temperature range (TS)	seal materials (*)
air, inert gas, water, oil	- 25°C to + 90°C	NBR (nitrile) FPM (fluoroelastomer)

Materials in contact with fluid

(*) Ensure that the compatibility of the fluids in contact with the materials is verified

Body Brass or Stainless steel, AISI 304
Shading coil Copper or Silver
Core tube Stainless steel, AISI 305
Core and plugnut Stainless steel, AISI 430F
Springs Stainless steel, AISI 302
Seals NBR
Disc NBR
Upper disc FPM
Core guide POM

Electrical characteristics

Coil insulation class F
Connector Spade plug (cable Ø 6-10 mm)
Connector specification ISO 4400 / EN 175301-803, form A
Electrical safety IEC 335
Electrical enclosure protection Moulded IP65 (EN 60529)
Standard voltages DC (=) : 24V - 48V
 (Other voltages and 60 Hz on request) AC (~) : 24V - 48V - 115V - 230V/50 Hz

operator ambient temperature range (TS) (°C)	power ratings			replacement coil ⁽¹⁾	
	inrush ~ (VA)	holding ~ (W)	hot/cold = (W)	~	=
-25 to +55	50	25	10,1	8,5/11,6	238613-059 238713-006

⁽¹⁾ All 238 basic numbers are UL & CSA approved and marked with the UR (recognised component) & CSA logos.

Options

- **Seals and disc (*)** (fluid temperature range) ⁽²⁾ FPM (fluoroelastomer):
-15°C to +120°C (AC)
-15°C to +90°C (DC)
- Oxygen service, FPM disc and seals, see "15-DIGIT PRODUCT CODE"
- Connector with visual indication and peak voltage suppression or with cable length of 2 m
- Explosionproof enclosures for use in zones 1/21-2/22, categories 2-3 to ATEX Directive 2014/34/EU (See page: 3)

(*) Vérifier la compatibilité du fluide avec les matériaux en contact.

⁽²⁾ The minimum ambient temperature of the solenoid valve is determined by the limitations of minimum temperature indicated.

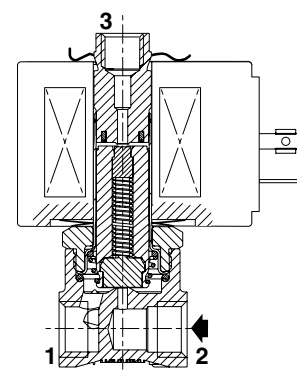

NC function (1/8)

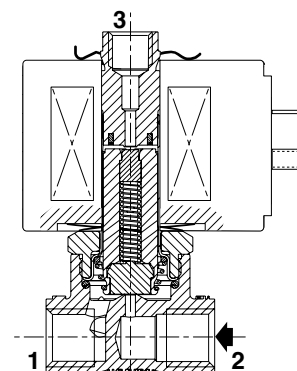

NC function (1/4)

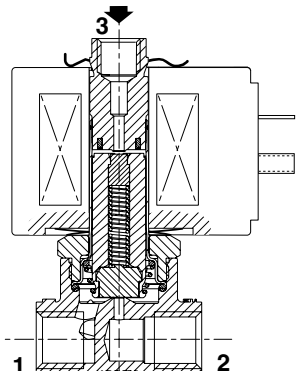

NO function (1/4)

Direct Operated, 1/8" or 1/4" tapped

Specifications

pipe size	orifice size	flow coefficient Kv		operating pressure differential (bar)						power coil (W)		thread type	dimensions / type (h)	15-DIGIT PRODUCT CODE		voltage code								
				2 → 1			1 → 3							max. (PS)			brass	stainless steel	24 V/50 Hz	48 V/50 Hz	115 V/50 Hz	230 V/50 Hz	24 V/DC	48 V/DC
		(mm)	(m³/h)	(l/min)	(m³/h)	(l/min)	min.	air (*)	water (*)	oil (*)	~			=	~	=	~	=	~	=	~	=	~	=
								~	=	~	=			~	=	~	=	~	=	~	=	~	=	~
Without manual operator																								
NC - Normally closed, NBR seal and disc																								
1/8	1,2	0,04	0,7	0,05	0,8	0	20	17	20	17	20	17	10,1	11,6	G	01	G314K031S1N00	G314K037S1N00						
	2,4	0,13	2,2	0,17	2,8	0	14	10	14	8	13	6	10,1	11,6	G	01	G314K032S1N00	G314K038S1N00						
	3,2	0,22	3,7	0,17	2,8	0	10	6	10	6	6,5	4,5	10,1	11,6	G	01	G314K033S1N00	G314K039S1N00						
1/4	1,2	0,04	0,7	0,05	0,8	0	20	17	20	17	20	17	10,1	11,6	G*	01	E314K034S1N00	E314K068S1N00						
	2,4	0,13	2,2	0,17	2,8	0	14	10	14	8	13	6	10,1	11,6	G*	01	E314K035S1N00	E314K121S1N00	FL	FR	FT	F8	F1	F9
	3,2	0,22	3,7	0,17	2,8	0	10	6	10	6	6,5	4,5	10,1	11,6	G*	01	E314K036S1N00	E314K126S1N00						
	4	0,43	7,1	0,17	2,8	0	5	3	5	3	5	3	10,1	11,6	G*	01	E314K130S1N00	E314K230S1N00						
	5,6	0,60	10	0,17	2,8	0	2,5	1,7	2,5	1,7	2,5	1,7	10,1	11,6	G*	01	E314K131S1N00	E314K231S1N00						
	7,1	0,73	12,1	0,17	2,8	0	1,7	1	1,7	1	1,7	1	10,1	11,6	G*	01	E314K132S1N00	E314K232S1N00						
U - Universal, NBR seal and disc																								
1/8	1,2	0,04	0,7	0,05	0,8	0	13	13	13	13	13	13	10,1	11,6	G	01	G314K041S1N00	G314K042S1N00						
	2,4	0,13	2,2	0,17	2,8	0	7	7	5,5	5,5	4	4	10,1	11,6	G	01	G314K043S1N00	G314K044S1N00						
	3,2	0,22	3,7	0,17	2,8	0	4,5	3,5	4,5	3	2,5	3	10,1	11,6	G	01	G314K045S1N00	G314K040S1N00						
1/4	1,2	0,04	0,7	0,05	0,8	0	13	13	13	13	13	13	10,1	11,6	G*	01	E314K006S1N00	E314K123S1N00						
	2,4	0,13	2,2	0,17	2,8	0	7	7	5,5	5,5	4	4	10,1	11,6	G*	01	E314K007S1N00	E314K120S1N00	FL	FR	FT	F8	F1	F9
	3,2	0,22	3,7	0,17	2,8	0	4,5	3,5	4,5	3	2,5	3	10,1	11,6	G*	01	E314K008S1N00	E314K124S1N00						
	4	0,43	7,1	0,17	2,8	0	2,5	1,7	2,5	1,7	2,5	1,7	10,1	11,6	G*	01	E314K127S1N00	E314K227S1N00						
	5,6	0,60	10	0,17	2,8	0	1,2	0,8	1,2	0,8	1,2	0,8	10,1	11,6	G*	01	E314K128S1N00	E314K228S1N00						
	7,1	0,73	12,1	0,17	2,8	0	0,68	0,55	0,68	0,55	0,68	0,55	10,1	11,6	G*	01	E314K129S1N00	E314K229S1N00						
NO - Normally open, NBR seal and disc																								
1/8	1,2	0,04	0,7	0,05	0,8	0	20	17	20	17	20	17	10,1	11,6	G	01	G314K049S1N00	G314K055S1N00						
	2,4	0,13	2,2	0,17	2,8	0	12	11	12	11	12	11	10,1	11,6	G	01	G314K050S1N00	G314K056S1N00						
	3,2	0,22	3,7	0,17	2,8	0	11	10	11	10	11	10	10,1	11,6	G	01	G314K051S1N00	G314K057S1N00						
1/4	1,2	0,04	0,7	0,05	0,8	0	20	17	20	17	20	17	10,1	11,6	G*	01	E314K052S1N00	E314K069S1N00						
	2,4	0,13	2,2	0,17	2,8	0	12	11	12	11	12	11	10,1	11,6	G*	01	E314K053S1N00	E314K122S1N00	FL	FR	FT	F8	F1	F9
	3,2	0,22	3,7	0,17	2,8	0	11	10	11	10	11	8	10,1	11,6	G*	01	E314K054S1N00	E314K070S1N00						
	4	0,43	7,1	0,17	2,8	0	10	4	10	4	10	4	10,1	11,6	G*	01	E314K133S1N00	E314K233S1N00						
	5,6	0,60	10	0,17	2,8	0	6,5	2,5	6,5	2,5	6,5	2,5	10,1	11,6	G*	01	E314K134S1N00	E314K234S1N00						
	7,1	0,73	12,1	0,17	2,8	0	4	1,7	4	1,7	4	1,7	10,1	11,6	G*	01	E314K135S1N00	E314K235S1N00						
With maintained manual operator																								
NC - Normally closed, NBR seal and disc																								
1/8	1,2	0,04	0,7	0,05	0,8	0	20	17	20	17	20	17	10,1	11,6	G	01	G314K031S1N01	G314K037S1N01						
	2,4	0,13	2,2	0,17	2,8	0	14	10	14	8	13	6	10,1	11,6	G	01	G314K032S1N01	G314K038S1N01						
	3,2	0,22	3,7	0,17	2,8	0	10	6	10	6	6,5	4,5	10,1	11,6	G	01	G314K033S1N01	G314K039S1N01						
1/4	1,2	0,04	0,7	0,05	0,8	0	20	17	20	17	20	17	10,1	11,6	G*	01	E314K034S1N01	E314K068S1N01						
	2,4	0,13	2,2	0,17	2,8	0	14	10	14	8	13	6	10,1	11,6	G*	01	E314K035S1N01	E314K121S1N01	FL	FR	FT	F8	F1	F9
	3,2	0,22	3,7	0,17	2,8	0	10	6	10	6	6,5	4,5	10,1	11,6	G*	01	E314K036S1N01	E314K126S1N01						
	4	0,43	7,1	0,17	2,8	0	5	3	5	3	5	3	10,1	11,6	G*	01	E314K130S1N01	E314K230S1N01						
	5,6	0,60	10	0,17	2,8	0	2,5	1,7	2,5	1,7	2,5	1,7	10,1	11,6	G*	01	E314K131S1N01	E314K231S1N01						
	7,1	0,73	12,1	0,17	2,8	0	1,7	1	1,7	1	1,7	1	10,1	11,6	G*	01	E314K132S1N01	E314K232S1N01						
U - Universal, NBR seal and disc																								
1/8	1,2	0,04	0,7	0,05	0,8	0	13	13	13	13	13	13	10,1	11,6	G	01	G314K041S1N01	G314K042S1N01						
	2,4	0,13	2,2	0,17	2,8	0	7	7	5,5	5,5	4	4	10,1	11,6	G	01	G314K043S1N01	G314K044S1N01						
	3,2	0,22	3,7	0,17	2,8	0	4,5	3,5	4,5	3	2,5	3	10,1	11,6	G	01	G314K045S1N01	G314K040S1N01						
1/4	1,2	0,04	0,7	0,05	0,8	0	13	13	13	13	13	13	10,1	11,6	G*	01	E314K006S1N01	E314K123S1N01						
	2,4	0,13	2,2	0,17	2,8	0	7	7	5,5	5,5	4	4	10,1	11,6	G*	01	E314K007S1N01	E314K120S1N01	FL	FR	FT	F8	F1	F9
	3,2	0,22	3,7	0,17	2,8	0	4,5	3,5	4,5	3	2,5	3	10,1	11,6	G*	01	E314K008S1N01	E314K124S1N01						
	4	0,43	7,1	0,17	2,8	0	2,5	1,7	2,5	1,7	2,5	1,7	10,1	11,6	G*	01	E314K127S1N01	E314K227S1N01						
	5,6	0,60	10	0,17	2,8	0	1,2	0,8	1,2	0,8	1,2	0,8	10,1	11,6	G*	01	E314K128S1N01	E314K228S1N01						
	7,1	0,73	12,1	0,17	2,8	0	0,68	0,55	0,68	0,55	0,68	0,55	10,1	11,6	G*	01	E314K129S1N01	E314K229S1N01						
NO - Normally open, NBR seal and disc																								
1/8	1,2	0,04	0,7	0,05	0,8	0	20	17	20	17	20	17	10,1	11,6	G	01	G314K049S1N01	G314K055S1N01						
	2,4	0,13	2,2	0,17	2,8	0	12	11	12	11	12	11	10,1	11,6	G	01	G314K050S1N01	G314K056S1N01						
	3,2	0,22	3,7	0,17	2,8	0	11	10	11	10	11	8	10,1	11,6	G	01	G314K051S1N01	G314K057S1N01						
1/4	1,2	0,04	0,7	0,05	0,8	0	20	17	20	17	20	17	10,1	11,6	G*	01	E314K052S1N01	E314K069S1N01						
	2,4	0,13	2,2	0,17	2,8	0	12	11	12	11	12	11	10,1	11,6	G*	01	E314K053S1N01	E314K122S1N01	FL	FR	FT	F8	F1	F9
	3,2	0,22	3,7	0,17	2,8	0	11	10	11	10	11	8	10,1	11,6	G*	01	E314K054S1N01	E314K070S1N01						
	4	0,43	7,1	0,17	2,8	0	10	4	10	4	10	4	10,1	11,6	G*	01	E314K133S1N01	E314K233S1N01						
	5,6	0,60	10	0,17	2,8	0	6,5	2,5	6,5	2,5	6,5	2,5	10,1	11,6	G*	01	E314K134S1N01	E314K234S1N01						
	7,1	0,7																						

Configurator - CAD Files

15-DIGIT PRODUCT CODE

E 314 K 034 S1 N00 F1

Thread connection

- G = ISO 228/1 (1/8)
- E = ISO 228/1 & ISO 7/1 (combination thread, G*)
- 8 = NPT (SAE 71051) [contact us]

Product series

314

Revision letter

K = Initial release

Valves version

Electrical interface & explosion proof options

- S1 = With spade plug connector
- MA= Steel enclosure, M20 cable gland, IP67 (equivalent to WP)
- MC= Steel enclosure, 1/2 NPT conduit, IP67 (equivalent to WPT)
- MD= Steel enclosure, M20 conduit, IP67 (equivalent to WPET)
- MF = Stainless Steel enclosure, M20 cable gland, IP67 (equivalent to WS)
- MG= Stainless Steel enclosure, 1/2 NPT conduit, IP67 (equivalent to WST)
- MH= Stainless Steel enclosure, M20 conduit, IP67 (equivalent to WSET)
- MV= Steel enclosure, M20 cable gland, IECEx/ATEX
II 2G Ex eb mb IIC Gb/II 2D Ex tb IIIC Db, zone 1-21 (equivalent to EM prefix)⁽¹⁾
- MT = Steel enclosure, 20 mm conduit, IECEx/ATEX
II 2G Ex eb mb IIC Gb/II 2D Ex tb IIIC Db, zone 1-21 (equivalent to EMET prefix)⁽¹⁾
- MN= Steel enclosure, 1/2 NPT conduit, IECEx/ATEX
II 2G Ex eb mb IIC Gb/II 2D Ex tb IIIC Db zone 1-21 (equivalent to EMT prefix)⁽¹⁾
- MW= AISI 316L enclosure, M20 cable gland, IECEx/ATEX
II 2G Ex eb mb IIC Gb/II 2D Ex tb IIIC Db, zone 1-21 (equivalent to WSEM prefix)⁽¹⁾
- MU= AISI 316L enclosure, 20 mm conduit, IECEx/ATEX
II 2G Ex eb mb IIC Gb/II 2D Ex tb IIIC Db, zone 1-21 (equivalent to WSEMET prefix)⁽¹⁾
- MS = AISI 316L enclosure, 1/2 NPT conduit, IECEx/ATEX
II 2G Ex eb mb IIC Gb/II 2D Ex tb IIIC Db, zone 1-21 (equivalent to WSEMT prefix)⁽¹⁾
- A7 = Moulded enclosure, epoxy encapsulated, integrated cable, IECEx/ATEX
II 2G Ex mb IIC Gb / II 2D Ex mb IIIC Db, zone 1-21 (equivalent to PV prefix)⁽¹⁾
- SG = Moulded coil with connector, epoxy encapsulated, ATEX
II 3GD Ex ec IIC Gc / II 3GD Ex tc IIIC Dc, zone 22 (equivalent to SG prefix)⁽¹⁾

Voltage - class

- FL = 24 V / 50 Hz - class F
- FR = 48 V / 50 Hz - class F
- FT = 115 V / 50 Hz - class F
- F8 = 230 V / 50 Hz - class F
- F1 = 24 V DC - class F
- F9 = 48 V DC - class F

Options

Without manual operator

- N00 = NBR disc and seals
- V00 = FPM disc and seals
- VN0 = FPM disc and seals for Oxygen service

With maintained manual operator

- N01 = NBR disc and seals
- V01 = FPM disc and seals
- VN1 = FPM disc and seals for Oxygen service

⁽¹⁾ Search prefix in asco.com to get detailed technical information.

Please note that the valve pressure ratings with some of the ATEX enclosures will be reduced.

To obtain the correct pressure rating please check the landing pages of the "3-Way Solenoid Valve DIN Configurator".

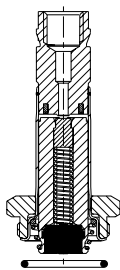
		Spare parts kits no. (*)							
		AC (~)				DC (=)			
		NBR	FPM	FPM (oxygen)		NBR	FPM	FPM (oxygen)	
	E314K006	M200074	N00	V00	VN0	M200074	N00	V00	VN0
	E314K007/008	M200078	N00	V00	VN0	M200075	N00	V00	VN0
	E314K034	M200070	N00	V00	VN0	M200066	N00	V00	VN0
	E314K035/036	M200071	N00	V00	VN0	M200067	N00	V00	VN0
	E314K052	M200080	N00	V00	VN0	M200080	N00	V00	VN0
	E314K053/054	M200081	N00	V00	VN0	M200081	N00	V00	VN0
	E314K068	M200072	N00	V00	VN0	M200068	N00	V00	VN0
	E314K069	M200082	N00	V00	VN0	M200082	N00	V00	VN0
	E314K070	M200083	N00	V00	VN0	M200083	N00	V00	VN0
	E314K120	M200079	N00	V00	VN0	M200077	N00	V00	VN0
	E314K121	M200073	N00	V00	VN0	M200069	N00	V00	VN0
	E314K122	M200083	N00	V00	VN0	M200083	N00	V00	VN0
	E314K123	M200076	N00	V00	VN0	M200076	N00	V00	VN0
	E314K124	M200079	N00	V00	VN0	M200077	N00	V00	VN0
	E314K126	M200073	N00	V00	VN0	M200069	N00	V00	VN0
	E314K127/128/129	M200078	N00	V00	VN0	M200075	N00	V00	VN0
	E314K130/131/132	M200071	N00	V00	VN0	M200067	N00	V00	VN0
	E314K133/134/135	M200081	N00	V00	VN0	M200081	N00	V00	VN0
	E314K227/228/229	M200079	N00	V00	VN0	M200077	N00	V00	VN0
	E314K230/231/232	M200073	N00	V00	VN0	M200069	N00	V00	VN0
	E314K233/234/235	M200083	N00	V00	VN0	M200083	N00	V00	VN0
	G314K031	M200070	N00	V00	VN0	M200066	N00	V00	VN0
	G314K032/033	M200071	N00	V00	VN0	M200067	N00	V00	VN0
	G314K037	M200072	N00	V00	VN0	M200068	N00	V00	VN0
	G314K038/039	M200073	N00	V00	VN0	M200069	N00	V00	VN0
	G314K040	M200079	N00	V00	VN0	M200077	N00	V00	VN0
	G314K041	M200074	N00	V00	VN0	M200074	N00	V00	VN0
	G314K042	M200076	N00	V00	VN0	M200076	N00	V00	VN0
	G314K043	M200078	N00	V00	VN0	M200075	N00	V00	VN0
	G314K044	M200079	N00	V00	VN0	M200077	N00	V00	VN0
	G314K045	M200078	N00	V00	VN0	M200075	N00	V00	VN0
	G314K049	M200080	N00	V00	VN0	M200080	N00	V00	VN0
	G314K050/051	M200081	N00	V00	VN0	M200081	N00	V00	VN0
	G314K055	M200082	N00	V00	VN0	M200082	N00	V00	VN0
	G314K056/057	M200083	N00	V00	VN0	M200083	N00	V00	VN0

* Vérifier la compatibilité du fluide avec les matériaux en contact.

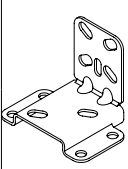
		Accessories code
	Mounting bracket Steel version (AISI 1010 / 1.1121)	M200094A00
	Mounting bracket Stainless steel version (AISI 304 / 1.4301)	M200095A00

Installation

- The solenoid valves can be mounted in any position without affecting operation
- Solenoid valves have 2 mounting holes in body
- Thread connection "E" applicable for 1/4 have standard thread according to ISO 228/1 and ISO 7/1. Thread connection "G" applicable for 1/8, have standard thread according to ISO 228/1
- Thread connection "8" have standard thread = NPT (SAE 71051) (contact us)
- Installation/maintenance instructions are included with each valve

Dimensions (mm), Weight (kg)

Configurator - CAD Files



TYPE 01
Electrical interface "S1"
Epoxy moulded
IEC 335 / ISO 4400
IP65

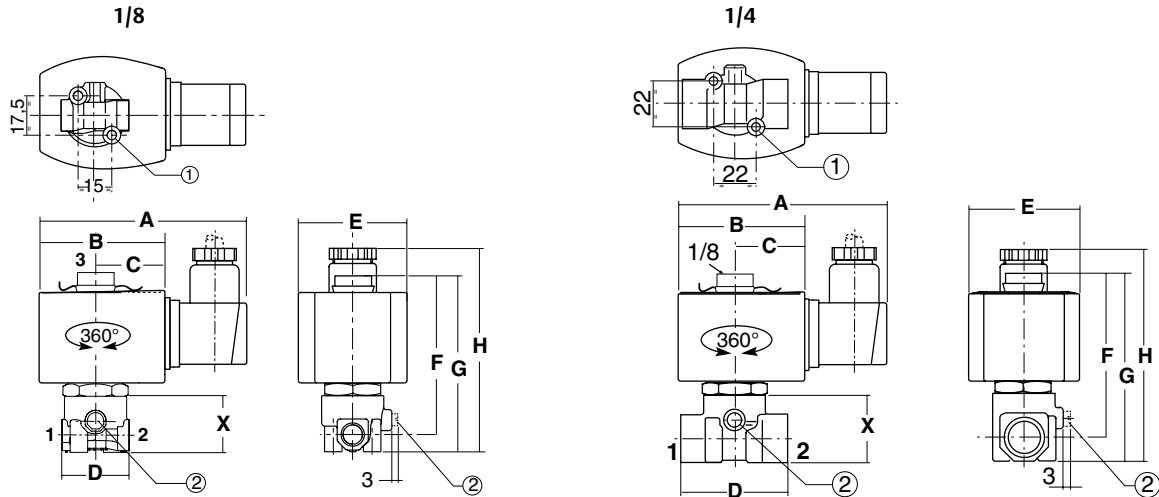

type	pipe size	A	B	C	D	E	F	G	H	X	weight ⁽¹⁾
01	1/8	95	57	33	31	50	71	79	90	26	0,30
	1/4	95	57	33	40	50	73	82	96	30	0,59

- ① 2 mounting holes M5 dia., depth 6 mm.
- ② Manual operator location.

⁽¹⁾ Incl. coil(s) and connector(s).

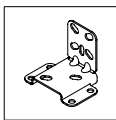

Mounting bracket
Steel or stainless steel

M200094A00 / M200095A00

