

ASCO™ MINIATURE SOLENOID VALVES

FLAPPER FLUID ISOLATION VALVES, 16mm

- Flapper isolation valves are designed for use with neutral or highly aggressive liquids in analytical and medical systems
- Special Flapper mechanism results in no pumping or sticking effects
- Reduced heat transfer between control mechanism and fluid make them ideal for use with heat-sensitive reagents and biological samples
- Hermetic separation of control mechanism prevents particulate contamination caused by friction of moving parts, assuring maximum purity of liquid samples
- Excellent self-draining capability and easy-to-flush low-volume internal cavity make these valves ideal in application where cross-contamination must be minimized
- Meets all relevant CE directives, and is RoHS compliant
- Typical applications include:
 - In-vitro Diagnostics
 - Hematology
 - DNA Sequencing
 - Industrial Liquid Analyzers

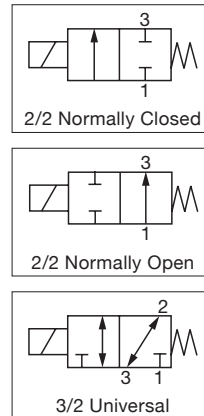

Fluids*	Temperature Range	Seal Materials*
Liquids or Gases ¹	5 °C to 50 °C (41 °F to 122 °F)	FFKM
		FKM
		EPDM

¹ Filtration: 50µm

* Ensure that the compatibility of the materials in contact with the fluids is verified

General Valve Information	
Body	PEEK
Others	Stainless Steel
Response Time	< 20ms
Internal Volume	75µl
Max. Viscosity	20 cSt (mm ² /s)

Electrical Characteristics	
Coil Insulation Class	F
Connector	Spade terminals or lead wires ²
Connector Specification	Spade terminals: DIN 46340, lead wires: 24 AWG
Electrical Safety	IEC 335
Electrical Enclosure Protection	Molded IP65 spade terminals (EN 60529) Molded IP66 lead wires (EN 60529)
Standard Voltages*	12 VDC, 24 VDC (-5%/+10%)

Electrical Connection	Power Ratings			Ambient Temperature Range	Type1
	Inrush VA	Holding VA	Hot/Cold W		
S0	-	-	-	5 to 50 (41 to 122)	01
L0	-	-	-		02

* Other voltages or coil with red LED for power supply signal on request

¹ Refer to the drawings on following pages

² 0.5m (19.7in) lead wires

Functional Principle

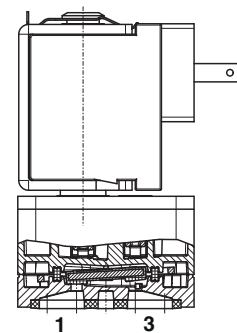

Function 2/2 NC

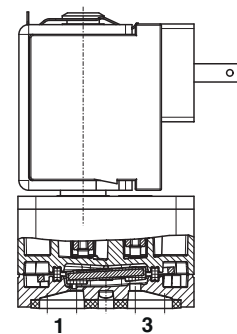

Function 2/2 NO

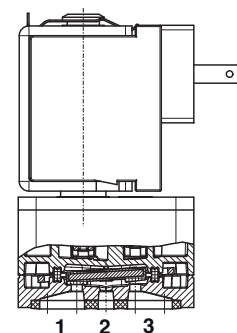

Function 3/2 U

01044GB-2019-R01

Specifications						
Connection	Orifice Size	Flow Coefficient		Operating Pressure bar (psi)		Power Rating (W)
				min.	max. gases or liquids	
	mm (inches)	Kv (m³/h)	Cv			
Pad Mounting ¹	0.8 (0.031)	0.021	0.024	-0.9 (-13)	8 (116)	4
	1.2 (0.047)	0.036	0.042	-0.9 (-13)	4 (58)	4
	1.6 (0.063)	0.042	0.049	-0.9 (-13)	2 (29)	4
1/4-28 UNF	0.8 (0.031)	0.021	0.024	-0.9 (-13)	8 (116)	4
	1.2 (0.047)	0.036	0.042	-0.9 (-13)	4 (58)	4
	1.6 (0.063)	0.042	0.049	-0.9 (-13)	2 (29)	4
Push-in Hose Connection	0.8 (0.031)	0.021	0.024	-0.9 (-13)	8 (116)	4
	1.2 (0.047)	0.036	0.042	-0.9 (-13)	4 (58)	4
	1.6 (0.063)	0.042	0.049	-0.9 (-13)	2 (29)	4

¹ 2 hexagon socket head cap mounting screws M2.5, stainless steel, supplied

How to Order

R 068A 2 1 2 SO V 00 F1

Prefix
R = Pad Mount
0 = 1/4-28 UNF
6 = Push-in hose connection

Series and release

Mounting width
2 = 16mm

Function
1 = 2/2 NC
2 = 2/2 NO
3 = 3/2 U

Voltage
F1 = 24 VDC
F3 = 12 VDC

Valve type
00 = On/off valve

Seal material
V = FKM
1 = FFKM
E = EPDM

Electrical connection
SO = DIN spade plug
LO = Leaded coil

Orifice size
2 = 0.8mm
4 = 1.2mm
6 = 1.6mm

Options

Description	Catalog Number
Push-in-Hose Barb Kit 3/2	
Subbase Qty: 1	534662-001
Hex nut Qty: 2	
Push-in-Hose Barb Kit 2/2 Codification	
Subbase Qty: 1	534662-002
Hex nut Qty: 2	
1/4-28 Threaded Kit 3/2	
Subbase Qty: 1	534661-001
Hex nut Qty: 2	
1/4-28 Threaded Kit 2/2	
Subbase Qty: 1	534661-002
Hex nut Qty: 2	

Subbases available on request

Installation

- The solenoid valves can be mounted in any position without affecting operation
- Pad-mounting solenoid valve supplied with seal

01044GB-2019-R01

ASCO™ MINIATURE SOLENOID VALVES

FLAPPER FLUID ISOLATION VALVES, 16mm

Dimensions: mm (inches)

Type 01

Solenoid with spade terminals (S0)
DIN 46340
IP40

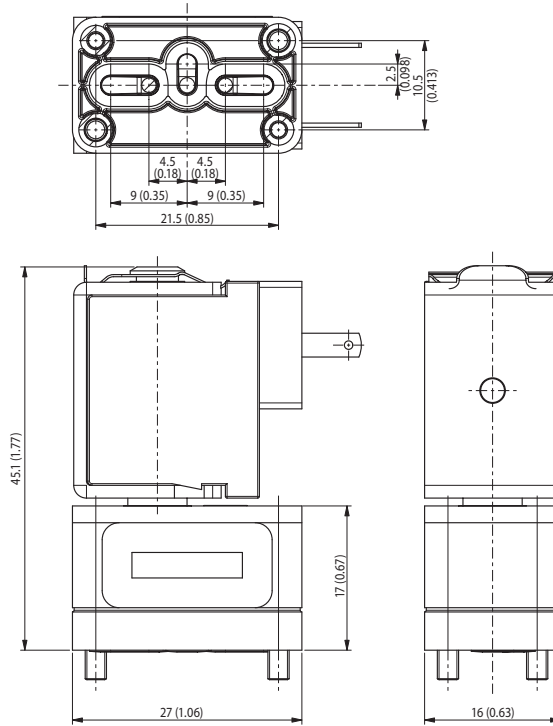

Type 02

Leaded coil (L0)
24 AWG, lead wires:
500mm (19.7in) long
IP66

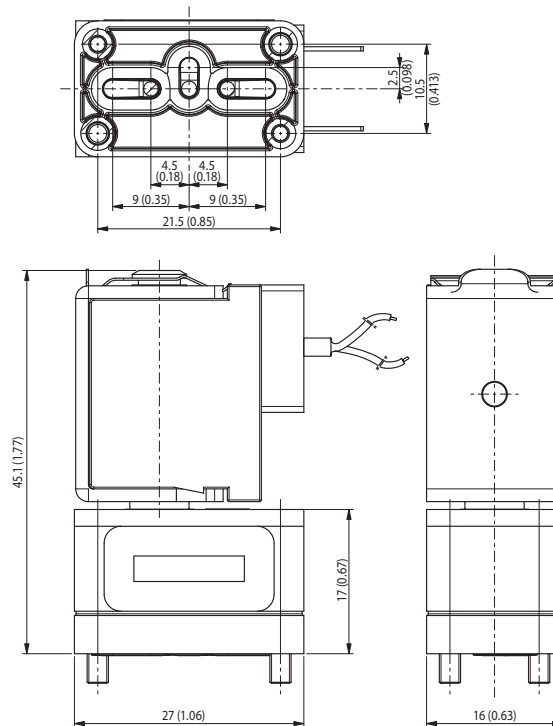

01044GB-2019-R01

Dimensions: mm (inches)

Subbase Mounting Pattern

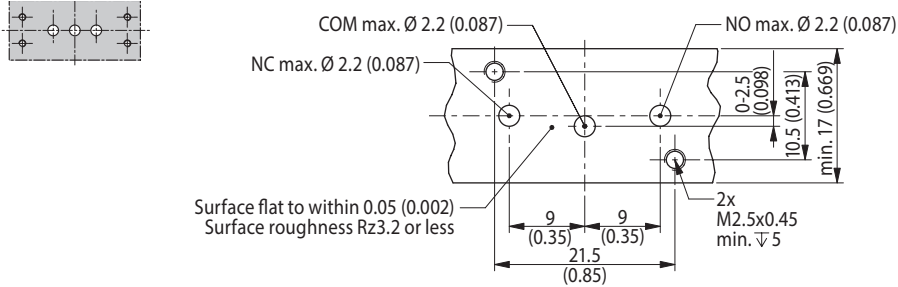

1/4 - 28 UNF Version

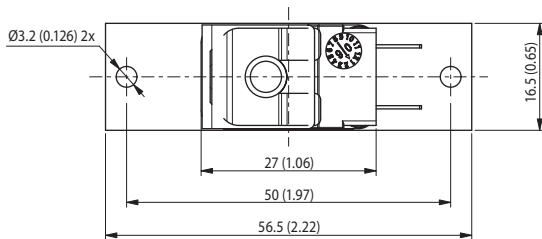
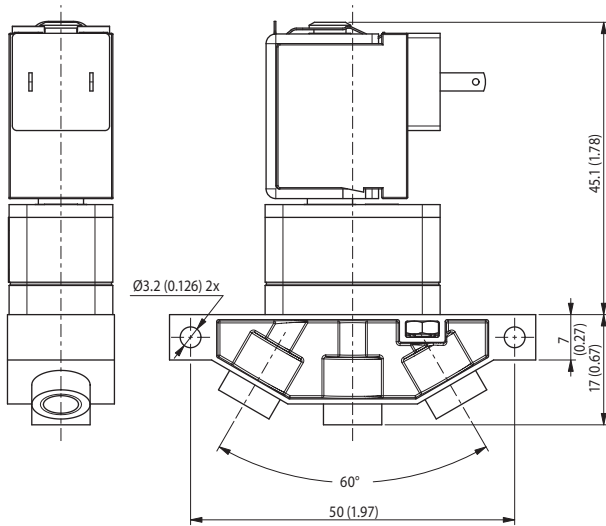

Version with Push-in Hose Connection

