

**Improve your network efficiency,
reliability and safety**

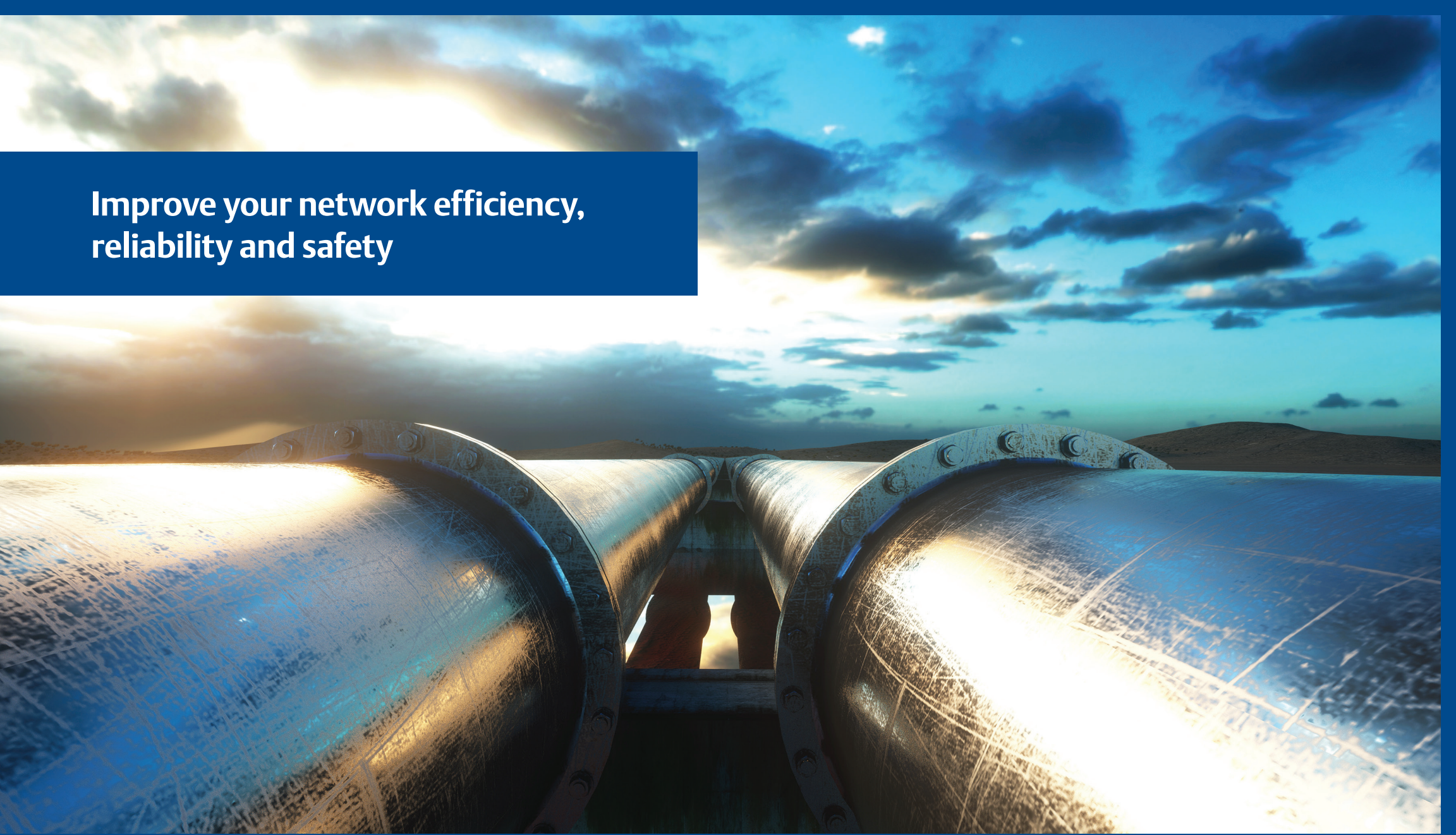

Natural Gas Smart Grid Management

Proven solutions to help you overcome your toughest challenges for process efficiency in your pressure reducing and metering stations





A smart grid management can raise key performance parameters to world-class levels.

Gain full control of your natural gas transmission and distribution network and improve efficiency, reliability, and safety

Managing entire natural gas grids includes diversifying gas sources and expanding the customer base while balancing both ends to ensure reliable, safe and efficient operations. To satisfy this, transmission and distribution companies design redundant safety layers and oversized grids while operating them at the highest pressure levels which increases gas leaks.

Frequent on-site interventions are necessary to perform regular checks and set up pressure reducing equipment to accommodate seasonal service condition changes which is a challenge as valuable field engineering resources are scarce. This impacts gas utilities' financial bottom line while exposing them to environmental fines.

“Some pipelines are in transient operations over 60% of the time.”

– *Pipeline & Gas Journal, 2004*



“In process plants, 50% of all maintenance work is not necessary and 10% is actually harmful.”

– *Gartner Group study, Expertune Inc., 2011*



“Spending on HSE alone in the global O&G industry will jump 60% to hit \$56 billion in 2030.”

– *Lux Research, 2013*



Emerson's solutions for natural gas grid operational certainty

Remotely and automatically controlling your entire operations, from pressure reducing equipment up to your gas transmission and distribution network, would allow you to have a safer and more productive management of your operations while reducing your costs.

Emerson expertise and smart grid management solutions can help you achieve top quartile operational certainty.

Increase the entire grid integrity and personnel safety by reducing pipeline constrains and reaction time

- Avoid working at stress limits to satisfy worst operating conditions
- Real-time diagnostics of the grid and the interconnected stations
- Active monitoring of safety devices

Increase your financial bottom line by adapting production to your real-time customer needs

- Centralize data control to balance multiple injection and delivery points
- Pressure and flow control
- Increase metering accuracy, service quality and customer satisfaction



Avoid on-site regular checks, seasonal pressure balancing adjustments and emergency shut down

- Continuous equipment health monitoring to avoid unexpected failures
- Evolve from unplanned and planned to predictive maintenance
- Emergency gas odorization backup

Reduce unneeded natural gas injection, self-consumption and loss through leakage to the atmosphere

- Optimize grid pressure to accommodate real customer needs
- Reduce leaks and gas losses, in compliance with European legislation
- Reduce noise pollution

Remote Automated Flow system at the core of smart grid management



As in many industries, most innovation in natural gas production, transmission and distribution is aimed towards smarter management.

The Emerson Remote Automated Flow (RAF) allows such smart management.

Incorporating a control unit, customizable touch screen interface and smart software, it is highly scalable with the ability to automatically manage individual equipment, a complete pressure reducing and metering station and an entire grid. To facilitate this, it includes an extensive range of communication modes to allow all kinds of local and remote connections. The programmable logic developed by true industry experts offers a variety of features which simplify, optimize and secure the management of any natural gas installation.

RAF customization capabilities allows to manage any natural gas installation		
<p>Integrated Architecture</p> <p>Main elements are a control unit, a touchscreen panel with I/O ports to communicate with a set of solenoid actuators, pressure, flow and temperature transducers.</p>	<p>Communication Capabilities</p> <p>Local & remote communication: webserver, USB, Ethernet, GPRS, RS485 / Possibility to interface with existing SCADA system through MODBUS TCP protocol.</p>	<p>Scalable Integration</p> <p>Ability to control single equipment, a complete pressure reducing and metering station and to assist in entire grid management.</p>
RAF core functionalities		
<p>Pressure & Flow Control</p> <p>Full control and monitoring of an entire pressure reducing and metering station. Allows the use of a regulator as a flow control valve.</p>	<p>Custody Transfer</p> <p>In flow control mode, the RAF can be set to limit the capacity within the meter range to improve the invoicing accuracy.</p>	<p>Gas Heating Optimization</p> <p>Optimization of the gas heating temperature by controlling the pre-heating boiler thermostat.</p>
<p>Odorant Injection</p> <p>Control of the entire odorant injection system, from odorant ratio to odorant level monitoring.</p>	<p>Biomethane Injection</p> <p>Ensure injected quality by monitoring the gas analysis results and redirecting the gas flow prior to injection, if necessary.</p>	<p>Pressure Profiling</p> <p>Optimize downstream pressure to provide only the required gas quantity thus reducing leaks to the atmosphere.</p>

Emerson's technology for Smart Grid Management

Pressure and capacity management

RAF is a scalable modular system that can be used in natural gas transmission and distribution infrastructure to provide full control and monitoring of an entire pressure reducing and metering station (PRMS). Acting directly on the pilot loading pressure, the RAF system can manage one or all the regulating lines based on customer logic requirements. The RAF system provides also smart modulation of distribution pressure based on real daily consumption profiles, allowing a reduction in the average distribution pressure. To put this into context, an average reduction of 3mabr in the outlet pressure of a low pressure distribution grid can bring up to 30% reduction of technical grid natural gas losses. The operators will be able to select from different operating logics such as:

- Outlet pressure remote control for grid balancing, seasonal adjustments, etc.
- On demand outlet pressure profiling to automatically adapt outlet pressure to daily consumption profile
- Reducing lines operating mode management (full range, split range, remote shutdowns, etc.)
- PRMS flow limitation, low flow management
- Monitoring of all the operating parameters, such as inlet/outlet/loading pressure and flow rates

Benefits

- Overcomes mechanical adjustment limitations
- Easy retrofit into existing stations
- Real-time diagnostics of the grid and interconnected district stations performance
- Correct balance of the grid pressure level
- Decreased noise level
- No impact on existing safety systems
- Zero bleed to atmosphere

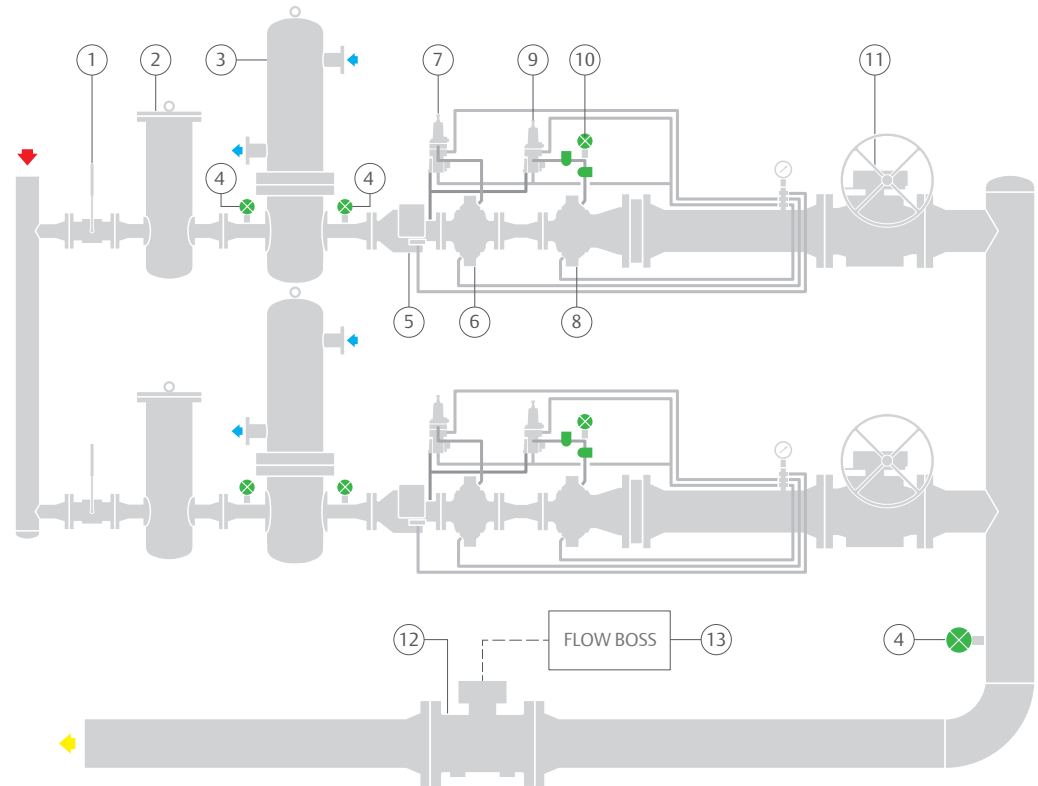

Legend

- | | | |
|--|--------------------------------|--|
| 1. Inlet valve | 5. Slam shut valve | 10. Solenoid valves and pressure transmitter for RAF control |
| 2. Filter | 6. Monitor regulator | 11. Outlet valve |
| 3. Heat exchanger | 7. Pilot for monitor regulator | 12. Flow meter |
| 4. Gas temperature transmitter for RAF control | 8. Regulator | 13. Flow computer |
| | 9. Pilot for regulator | |

"Methane is accountable for the 16% of global greenhouse gases and, thus is shorter-lived than CO₂, it has a much more powerful warming effect."

- IPCC, 2014

Emerson's technology for Smart Grid Management

Custody transfer applications

Flow meters do not have the same accuracy level across the entire capacity range.

A typical accuracy range between 20% and 100% of the flow rate is acceptable. Lower flow rates do not fall into this accuracy range and therefore are unacceptable.

In custody transfer applications the high level of accuracy required across the entire range can be problematic.

RAF can control these types of situations by limiting the capacity to a minimum value to guarantee an acceptable level of accuracy.

RAF also permits meter protection in the case of overflow/overspeed situations.

Benefits

- On-going accuracy and repeatability
- Compliance to regulations
- Reduced internal/external audits

Typical accuracy curve of a gas flow meter

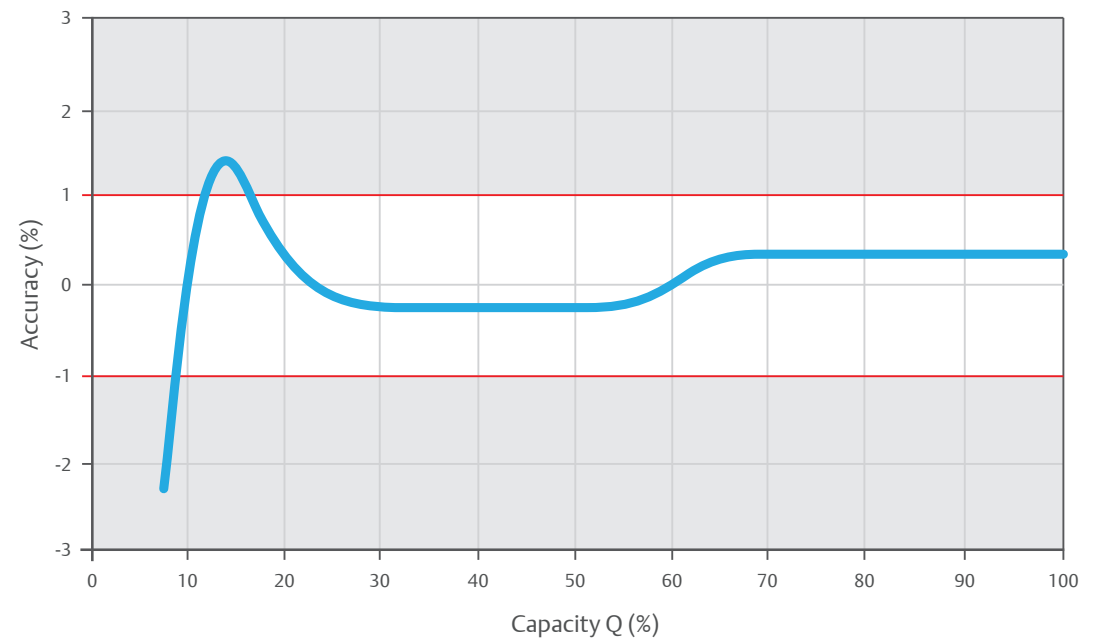

“A very large custody transfer system can meter \$2.2 billion of NG per year. A measurement error of 0.25% would potentially result in \$ 5.5 million of lost revenue.”
- *Control Engineering, 2010*

Emerson's technology for Smart Grid Management

Gas heating management

Another strong feature of the RAF system is the optimization of the gas heating system, used when necessary to increase the gas temperature. This will allow considerable savings in terms of energy consumption, as well as reducing GHG emissions.

The electronic control unit receives the gas and water inlet/outlet temperatures and, by acting on the thermostats of the pre-heating boilers, the system maintains the gas temperature at the minimum requested value.

RAF heating system control can be used with other heating media or electric heaters.

It also provides direct control of circulating pumps or any other device included in the heating system loop.

Substantial energy savings occur when these operations are used, allowing a return on investment for the complete system within 18 to 24 months.

Benefits

- Reduce energy consumption
- Optimize gas outlet temperature

For a City Gate supplying 5 MScm/year, RAF heating system control can save a minimum of 17,500 € per year. This corresponds to a ROI from 18 to 24 months.

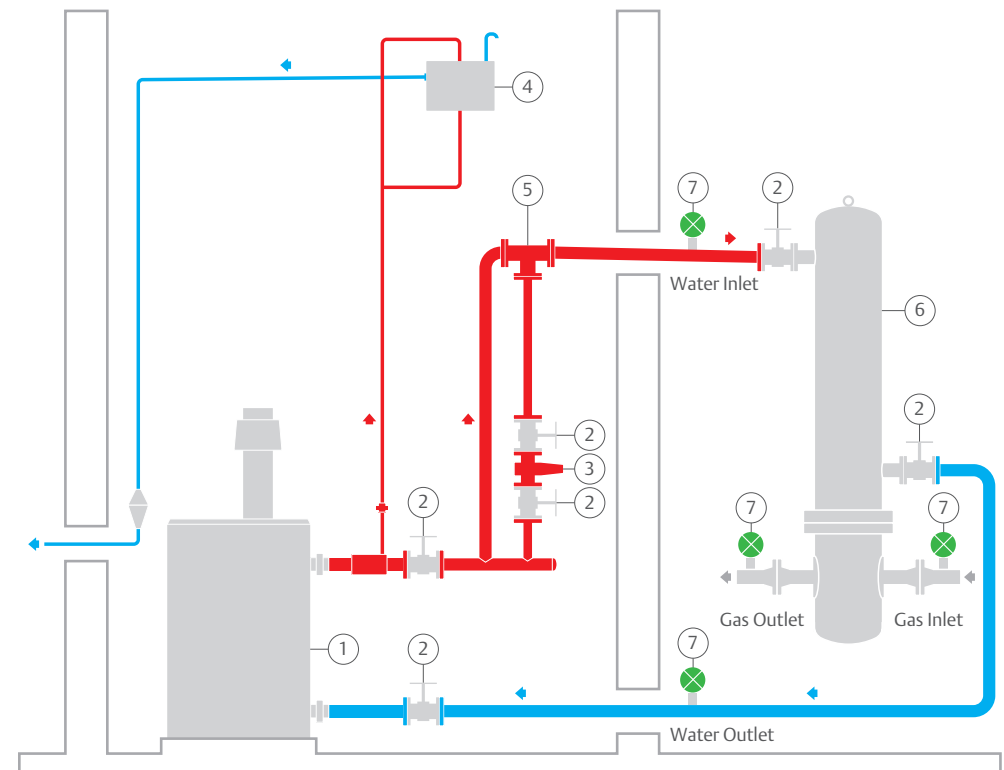

Legend

1. Boiler with temperature probe
2. On-off valve
3. Pump
4. Expansion tank
5. Three way non-return water valve
6. Heat exchanger
7. Gas temperature transmitter for RAF control
8. Water temperature transmitter for RAF control

Emerson's technology for Smart Grid Management

Odorant injection

National energy authorities take odorization into consideration when performing quality of service evaluations and they conclude that poor odorization can have a significant impact on operational costs. Traditional technologies, such as absorption and pump systems, produce several issues including uneven odorant distribution, unplanned downtime, and a subsequent increase in the time maintenance engineers must spend visiting units that are often located remotely.

The RAF control panel manages the odorant injection system, which is configured with solenoid valves, thus keeping track of the quantity of liquid injected and automatically adjusts the injection rate to maintain the odorant concentration ratio constant. This results in increased ease of use, reduced maintenance and remote access and control facility. The solenoid injectors maintain accuracy over the entire flow range of the system, approaching infinite turn down.

The RAF continually monitors the odorant level in the tank, reducing system complexity and probability of errors during tank refilling and odorant injection.

Benefits

- Ease of use and reduced maintenance
- Reduced system complexity and possibility of failures
- Increased system accuracy and reliability
- Decreased operating costs

“Odorant injection is considered the easiest form of leak detection.”
- PHMSA, 2002

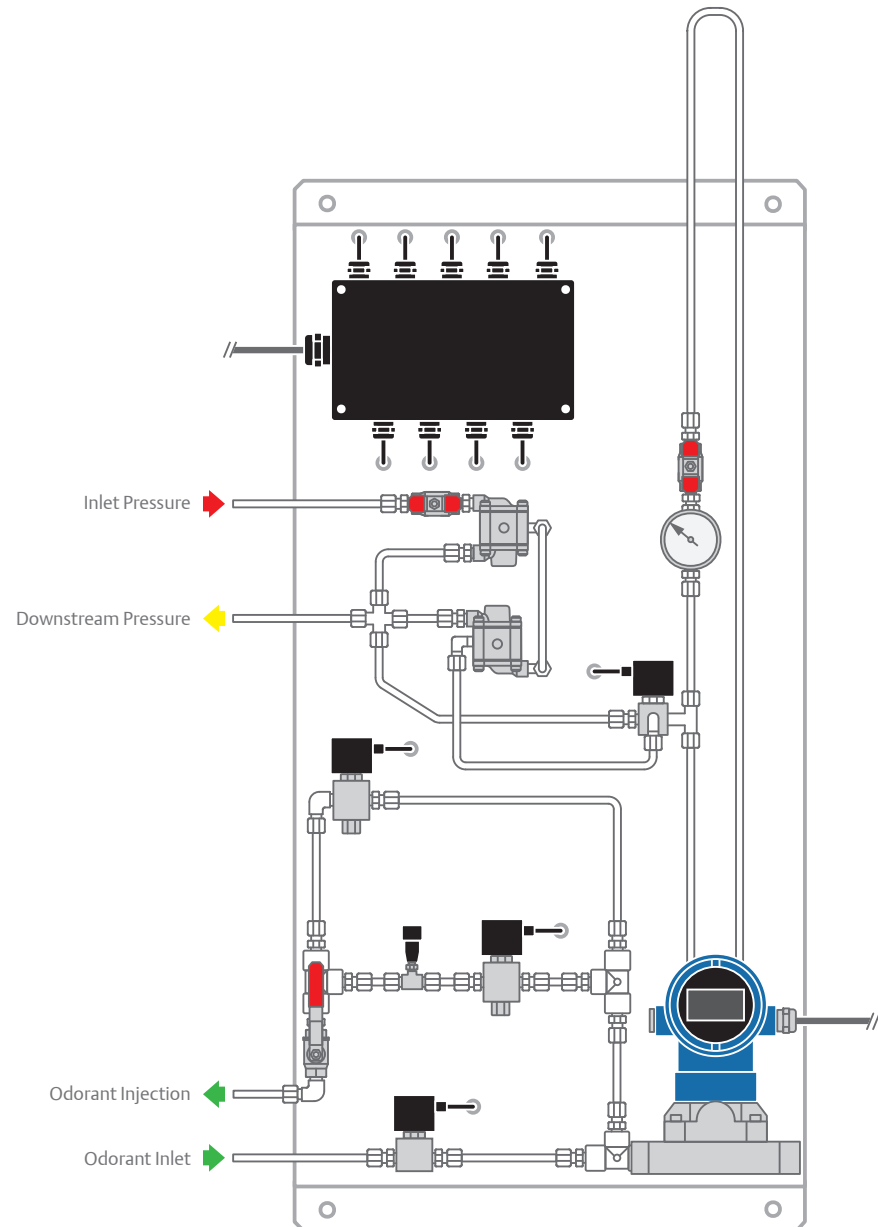

Emerson's technology for Smart Grid Management

Biomethane applications

Biomethane presents a great new opportunity for Europe in terms of a low cost, eco-friendly form of energy and the market for this product is growing rapidly. New regulations within many European countries not only enables biomethane to be added to natural gas networks, but also incentivizes the increase in the amount of biomethane added to the grid.

In order to inject biomethane into the natural gas grid, dedicated injection skids are built. They consist of several sections: gas analysis, a 3-way valve, filtration, metering, pressure reducing and odorization.

All these sections must work together seamlessly to ensure the optimum performance of the system. The RAF system can manage all of these devices, gather feedback from them, and take the necessary actions to safely inject into the grid a precise quantity of biomethane of the required quality.

Benefits

- Manage all the components and system from a single source
- Ensure compliance to standards and regulations
- Deliver continued, reliable, efficient, and safe operations

“Europe has a potential of biomethane production of between 151 and 246 billions of cubic meters per year; by 2025 new biogas plant will be built across the world to produce approximately 2.600 MW.”

- *Biofuels Digest, 2016*

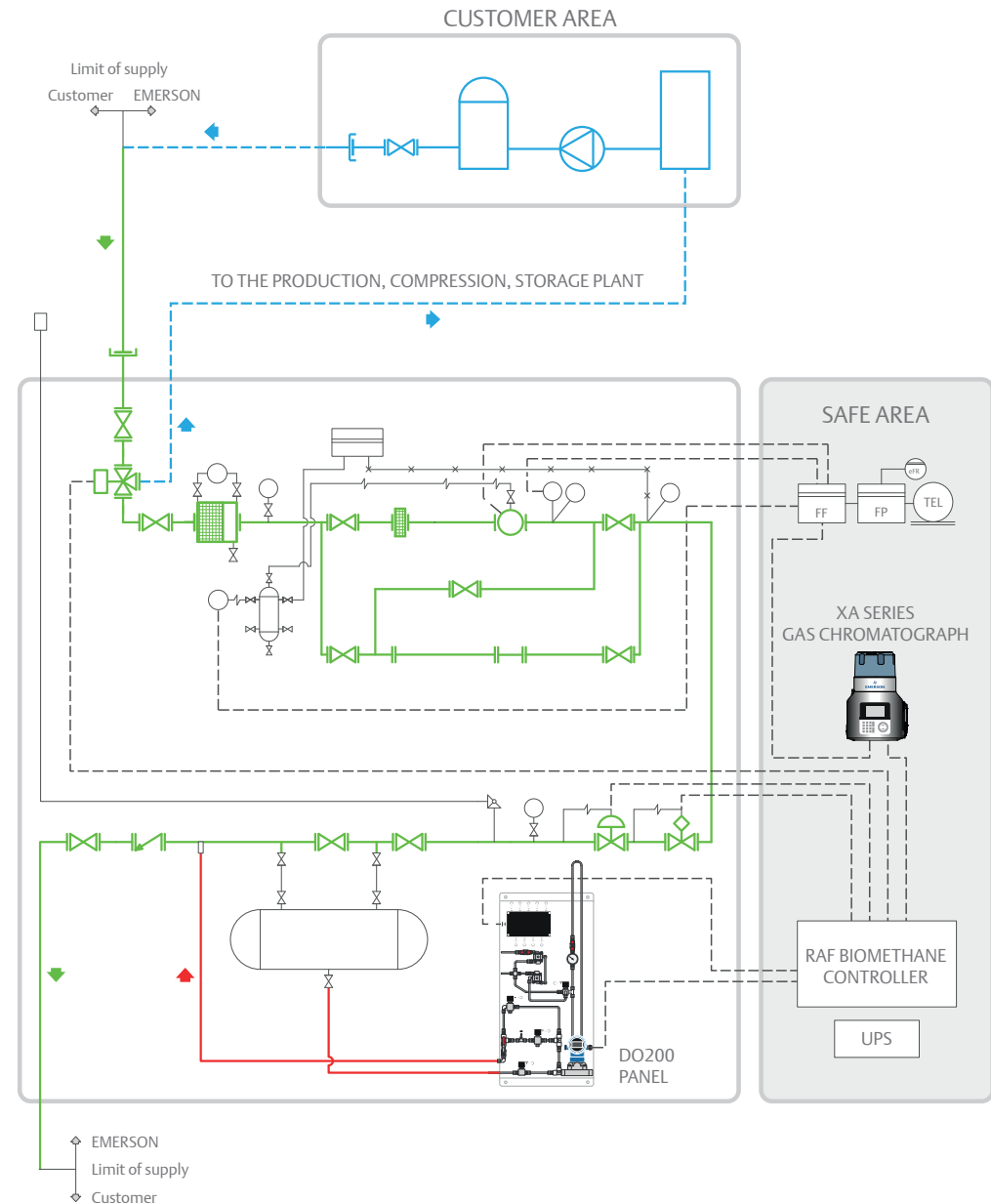

Emerson's technology for Smart Grid Management

Distribution network: Energy Harvesting Systems

One of the main challenges that have slowed down the adoption of the Smart technologies in the distribution network is that no electric power is usually available on site to feed the devices. Even in sites where electric power is available, the cost of connection and operating management has caused the proliferation of battery fed RTUs, that do not allow real time monitoring of what is happening in the grid, nor handling complex logics, commands and actuators that need various amounts of energy.

It is now possible to overcome this obstacle with the use of micro expanders and their correct integration into the pressure reducing stations. The micro expanders are miniaturized and portable energy generators that, taking inspiration from turbo machinery, use available pressure drop and transform it into electric power. The integration of the 'energy harvesting' system designed by Emerson, that foresees the supply of a pneumatic line in parallel to the regulating lines and independent from them, allows the correct deployment of this 'free of charge' energy source, together with an easy operation and maintenance. The available power levels, up to 30 W and up to 150 W, allow to adopt a wide variety of 'Smart' solutions for remote control of the outlet pressure, flow rate limitation, energy efficiency, monitoring of operating parameters and many additional functionalities (most of them already described in this brochure), for a modern and more efficient management of the distribution grid.

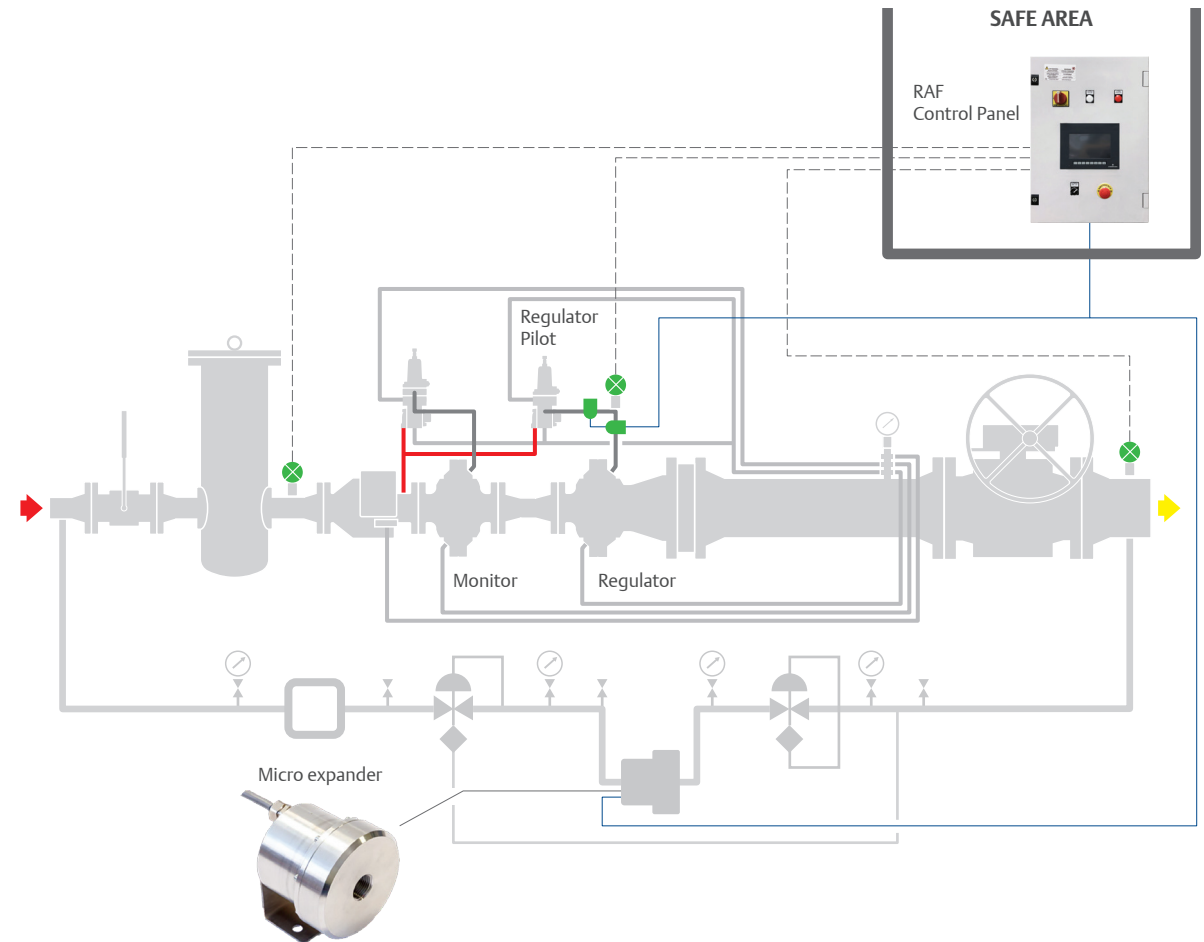

Benefits

- Have the ability to remotely control your pressure regulators
- Automatically adjust your station to the real needs of the end user
- Avoid trips on site, decreasing costs and improving safety

"Digital transformation is no longer just an option that some companies choose to pursue: it is rapidly becoming impossible to operate without adequate strategies in this regard."

- *Oil & Gas IQ Editor, 2019*

Emerson solutions

RAF Technology

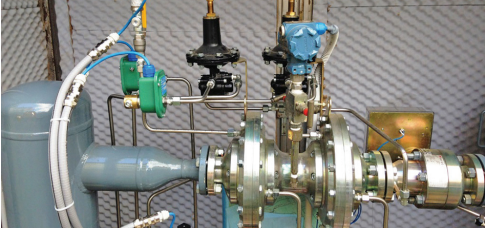

“One box” solution for ‘Smart’ PRMS and grid management applications.

- Applicable to all existing pilot operated regulators
- Open/Expandable modular architecture
- Low installation impact (does not affect existing installation layout)
- Online troubleshooting

Pressure Control

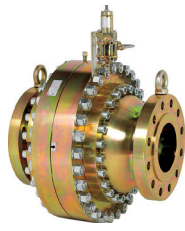

Regulators, valves and systems ensure accurate, safe and reliable pressure control operations.

- Pressure and backpressure regulators for precise pressure reducing operations

ASCO® Solenoid Valves



Where flow control meets pneumatics to create fluid automation solutions that maximize efficiencies, optimize applications, and enable customers to fulfill their true potential.

FISHER™ 4320



The Fisher 4320 wireless position monitor eliminates the need for wiring to an on/off, pneumatically actuated valve. It provides a precise wireless feedback signal to indicate equipment position with a percent of span plus on/off indication.

Systems and data management

Odorant Injection



Automatic and completely configurable system that ensures very high dosing accuracy and safe operations.

- Improve HSE performance
- Meet regulatory requirements
- Reduced maintenance and operating costs

Control & Data Management

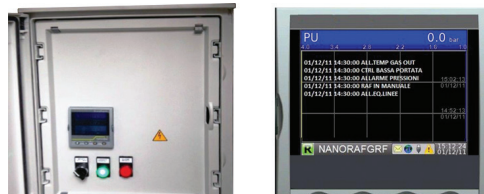

Devices and systems to completely overlook and control your system.

- Flow Computers, RTU, SCADA system
- Seamless integration with centralized control networks
- Intuitive/configurable platforms and application software

Pressure, Flow and Temperature Transmitters



Pressure, flow, and temperature transmitters with industry-leading performance help improve operations in a wide range of applications. Instrumentation provide solutions for critical measurement challenges even in the harshest environments.

Complete Systems



Complete pressure reducing and metering systems for optimized and cost effective solutions for each application.

- Compliance to local/global regulations standards
- Reduce vendor complexity and unclear responsibilities



For more information visit: www.Emerson.com

Solving the process industry's challenges, with predictable success, any time, any place

Emerson Automation Solutions Regulator Technologies

Americas

T +1 800 558 5853
T +1 972 548 3574

 webadmin.regulators@emerson.com

 EmersonProcess.com

Europe

T +39 051 419 0611

 Facebook.com/EmersonAutomationSolutions

 LinkedIn.com/company/emerson-automation-solutions

Asia Pacific

T +65 6770 8337

 Twitter.com/emr_automation

Middle East / Africa

T +971 4811 8100

Emerson Process Management s.r.l.

Emerson Automation Solutions - Stabilimento di/Site of: Castel Maggiore - Bologna

Sede Legale/Legal Entity: Piazza Meda 5, 20121 Milano, Italy

Sede Amministrativa/Administrative Headquarters: OMT Tartarini, Via Clodoveo Bonazzi 43,

40013 Castel Maggiore (Bologna), Italy

C.F. - P.I. e R.I. di MI 13186130152 - REA di MI/n.1622916

Direz. e Coord. (art. 2497 bis CC): EMERSON ELECTRIC CO. St. Louis (USA) Socio Unico

D352667X012 © 2017, 2021 Emerson Process Management Regulator Technologies, Inc. All rights reserved. 11/21.
The Emerson logo is a trademark and service mark of Emerson Electric Co. All other marks are the property of their prospective owners.



EMERSON. CONSIDER IT SOLVED.™