



**Multi-Component Gas Analysis with  
Speed, Repeatability, and Reliability**

**Rosemount™ Quantum Cascade Laser Analyzers**

Achieve unmatched gas monitoring performance and realize cost savings with the most advanced analysis technology in the industry.



# Expand Insight and Optimize Performance

Improve productivity, manage emissions, and ensure quality are daily challenges for operators – and areas of focus for regulators. Changes in processes, regulations, and workforce are pushing engineers, specialists, and technicians in every industry to seek out powerful but easy-to-use technologies that reduce the burden of gas analysis and improve overall operations.

## What if you could...

### **Improve Process Control with Fast, Reliable, Real-time Data**

- Multi-component analyzer delivers real-time measurement for greater and faster insight into the process.
- Analysis of up to twelve different gases – in a single instrument – provides broad application flexibility and process insight.
- Solid-state components and unique device package offer unmatched measurement reliability and decades of laser life for improved quality and increased uptime.

### **Lower Cost with Easy Installation, Operation, and Maintenance**

- Modular, simplified design improves reliability, enables easy upgrades, reduces plant maintenance, and simplifies technician's procedures.
- Future-proof analyzer inventory with easy in-field upgrades and maintenance.
- Installation and commissioning ease including one-day technician training and startup.
- Avoid costly shelters and enclosures to reduce install cost and avoid additional field maintenance.

### **Ensure Safety and Compliance with Superior Reliability**

- Sub-second measurements ensure operators can make adjustments to avoid upsets that can develop into emergencies.
- Accurate, reliable measurement of complex gases and emissions ensure regulatory compliance and avoid fines.
- Compact and rugged architecture module and field-tested devices for extreme operating environments in regulated industrial markets.

# Quantum Cascade & Tunable Diode Laser Analyzers

Emerson's advanced CT5000 Series Analyzers incorporate both Quantum Cascade Laser (QCL) and Tunable Diode Laser (TDL) technology to deliver the most sophisticated industrial gas sensing, analysis, and emission monitoring solution.

Features	Benefits
First hybrid QCL and TDL analyzer	Realize true savings from a more powerful device that gives greater process insight and analysis.
Multiple component measurement in a single device	Detect, analyze, and monitor up to twelve different gases and eliminate the need for multiple analyzers and sample handling systems.
Simple field service and upgrades	Simplify installation, commissioning, upgrades, and any required maintenance with intuitive user interface and all solid-state components.
Fully autonomous operation	Improve uptime with embedded ARM processor, rugged design for extreme environments, and 374 °F (190 °C) maximum sample cell operating temperature.
No consumables	Avoid expense and hassle of high amounts of gas consumables in daily operation.
No costly shelters or enclosures	Lower installation costs with in-the-field wall mount or rack mount configurations.
Calibrations seldom required	Reduce the need for validation/calibration frequency with Inherent calibration stability.

## Process Industries

- Chemical
- Petrochemical
- Refining
- Power
- Industrial Energy
- Gas Processing
- Marine

## Typical Applications

- Ethylene Production / Purity
- Continuous Emissions Monitoring
- NO<sub>x</sub> Reduction / Ammonia Slip
- Natural Gas Quality
- Combustion Control



CT5100 Continuous Gas Analyzer



CT5800 Continuous Gas Analyzer

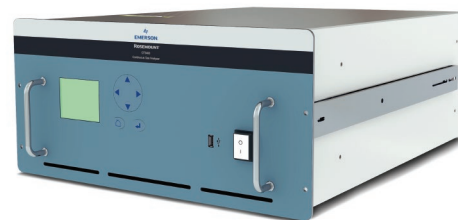

CT5400 Continuous Gas Analyzer

# Quantum Cascade Laser Technology

Emerson's Quantum Cascade Laser technology offers fast, high resolution spectroscopy to detect and identify a range of molecules in the mid-infrared wavelength range. Coupled with Tunable Diode Laser (TDL) spectroscopy, a single instrument is now able to broaden insight and monitor both the near and mid-infrared range of spectroscopic light.

The Rosemount QCL is a semiconductor laser that enables the emission of multiple photons by a single electron as the electron tunnels through a series of quantum wells. With careful design and attention to detail in production, QCL laser wavelengths can be tuned to excite a specific molecule or set of molecules in a precise 1–3 wavenumber range.

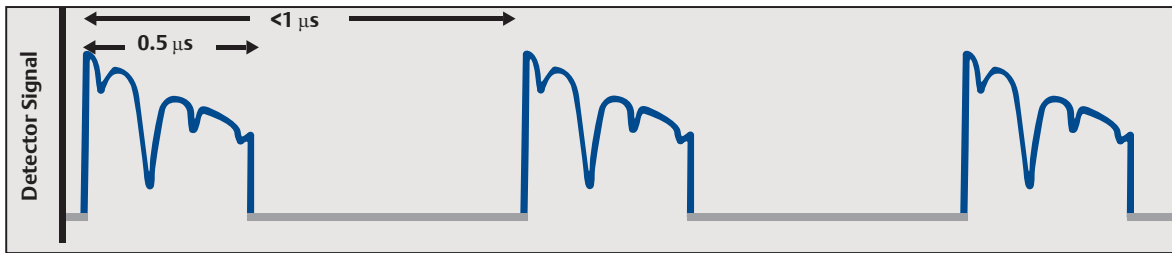

When power is applied, the QCL heats up and as the temperature rises, laser wavelengths begin to increase. The QCL then sweeps the wavelength frequencies to detect each component of interest before cooling the device to its original temperature. This patented laser chirp process occurs in under one microsecond, enabling thousands of spectra to be recorded each second.

QCL systems include up to six high-resolution lasers to measure both the near- and mid-infrared spectral regions for real-time, optimal gas measurement and analysis down to sub ppm concentrations.

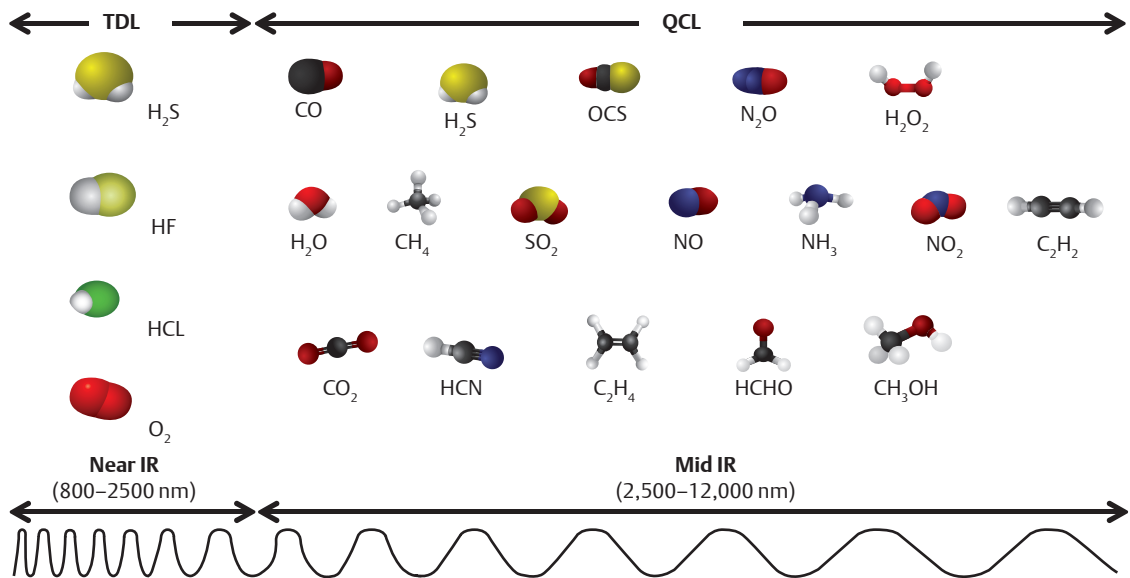

Using Rosemount QCL/TDL technology with patented laser chirp technique expands gas analysis to both the near and mid-infrared range to enhance process insight, improve overall gas analysis sensitivity and selectivity, remove cross interference, and increase response time.

### Simultaneous Gas Analysis

Up to six laser modules and patented laser chirp data capture technique isolates and analyzes up to twelve unique gas components.

1. **Optical bench base plate** – superior rigidity for continuous, high accuracy measurement that is immune to vibration and temperature changes
2. **Smart laser modules** – unique and sequenced laser chirp for fast, multi-component measurement
3. **Optical path mirrors** – direct light, rigid connection to base plate to ensure alignment
4. **Flow Cell** - designed to extend optical path length for greater resolution of low component (or analyte) concentrations
5. **Detector** - ultrafast detection of emitted light

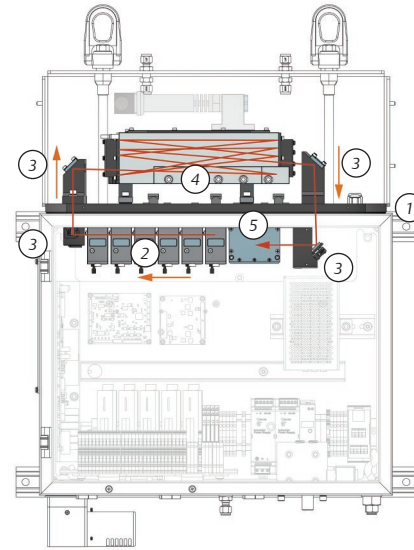

CT5100 Optical Bench

### Unmatched Component Detection and Analysis

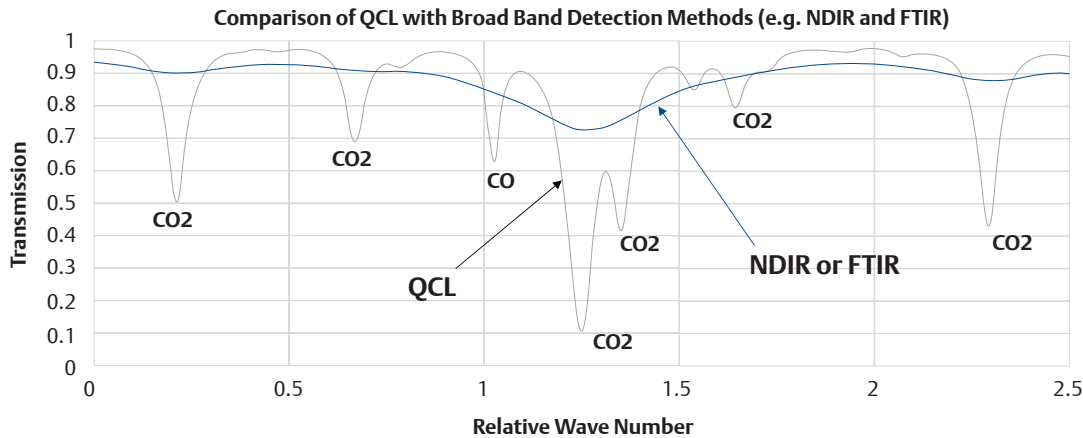

QCL and TDL narrow line width allow scanning of individual peaks of identified components with minimum interference and without filtration, reference cells, or chemometric manipulations.

### Rugged, Reliable QCL Laser Module

- Modular architecture easily serviceable and upgradeable in the field
- Packaged lasers are housed in rugged modules that can be repeatedly mounted/un-mounted to the optical bench without losing alignment
- Module is preconfigured with its unique characteristics for the QCL device
- Stable dowel mount with two screws and one ribbon cable ensure reliable operation in process environments
- Expert laser light alignment is factory set with no field alignment required



# Ethylene Production - Purity



Ethylene, one of the most valuable and in-demand olefins today, has stringent purity requirements that must be verified during production and at the point of custody transfer. Impurities can affect the molecule chain, may poison catalysts, and will always reduce the quality of the ethylene gas. To ensure high-quality ethylene production and purity, operators require ultrafast and precise detection and analysis of the concentrations of water, acetylene, and ammonia molecules during the manufacturing process.

## What's your challenge?



The presence of impurities can poison or oxidize valuable catalysts, form carbamates or carbonates that clog gas lines, and can often lead to costly repairs and downtime.

## What's your opportunity?



Precision detection of gas impurities is critical, regardless of how challenging an application. Rosemount QCL/TDL technology can detect even the smallest gaseous molecule with ultrafast speed and down to sub ppm concentrations.

## Typical Ethylene Process

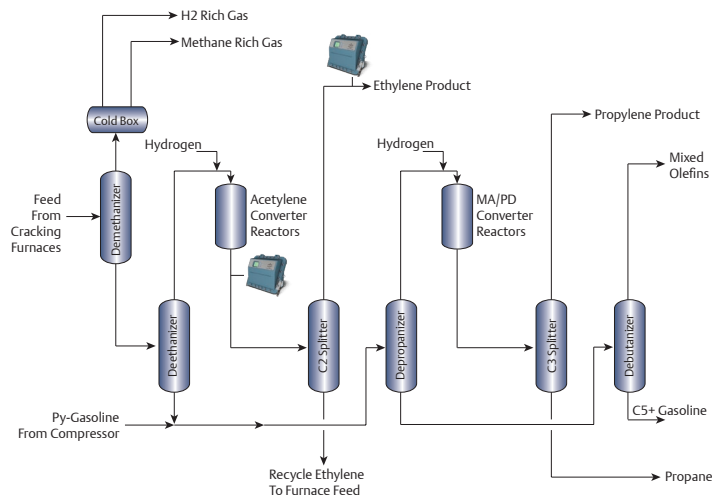

## Measurement Ranges

Component	Measurement Range		
	Range	LOD	Repeatability*
H <sub>2</sub> O	0–1 ppm	0.1	±1 %
CO <sub>2</sub>	0–1 ppm	0.05	±1 %
CO	0–1 ppm	0.05	±1 %
C <sub>2</sub> H <sub>2</sub>	0–10 ppm	0.2	±1 %
CH <sub>3</sub> OH	0–100 ppm	1.0	±1 %
NH <sub>3</sub>	0–10 ppm	0.2	±1 %
CH <sub>4</sub>	0–100 ppm	0.5	±1 %

\*Repeatability is ±1 % of reading or the Limit of Detection (LOD), whichever is greater.

## QCL Benefits for Ethylene Production and Purity

Rosemount Quantum Cascade Lasers deliver fast, reliable gas analysis that thoroughly monitors the presence of contaminants, including acetylene, CO, CO<sub>2</sub>, and moisture, to ensure the integrity of the ethylene process stream.

- Real-time monitoring helps avoid production upsets, process damage, and downtime
- High specificity and speed-of-response accurately identify the presence of elusive acetylene
- Patented laser chirp technique and sub-ppm analysis detect a range of impurities
- Thousands of scans every second calculate component measurement and ensures ethylene feedstock meet specifications
- No consumables, no calibration, and no in-field enclosure or shelters reduce installation issues and reduce cost
- Internal, solid-state, and modular design offers no moving parts to minimize maintenance and simplify upgrades
- Easy-to-use instrumentation and fast technician training

## Recommended Technology



### Rosemount™ CT5800 Continuous Gas Analyzer

- Unique cell design delivers highly accurate measurement of low concentrations of impurities in gas streams
- Designed for up to six Quantum Cascade Lasers
- Multi-component and simultaneous measurement in a single gas analyzer
- Ideal for ethylene purity application
- Flameproof enclosure for hazardous area applications

# Continuous Emissions Monitoring



Regulatory requirements to monitor and report emissions are a responsible practice for global industries. However, understanding evolving regulatory standards changes and options about technologies to control the emission of gaseous and particle pollutants can be a challenge. Continuous emissions monitoring systems (CEMS) help ensure compliance and, with highly accurate and reliable instrumentation, can even further improve the overall performance and insight into an operation.

## What's your challenge?



Environmental legislation continues to evolve and set stricter limits on a range of atmospheric pollutants. Operators are challenged to ensure CEMS analyzers are reporting accurately to prevent costly fines or unexpected shutdowns.

## What's your opportunity?



Rosemount's QCL/TDL technology delivers superior emissions monitoring coverage with high reliability and low maintenance that assure greater analyzer availability.



## Typical CEMS Process

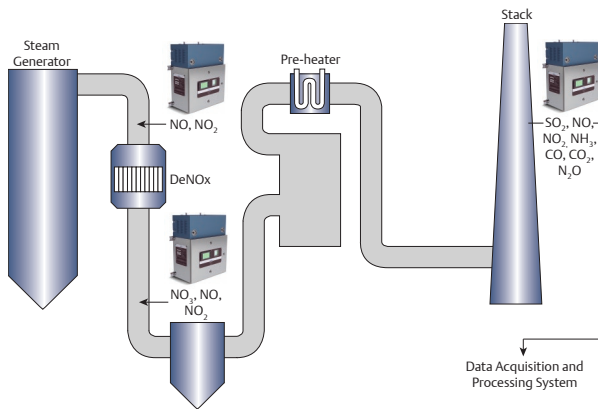

## Measurement Ranges

Component	Measurement Range				
	Range	LOD	Range	LOD	Repeatability*
NO	0–10 ppmv	0.1 ppmv	0–15 mg/Nm <sup>3</sup>	0.2 mg/Nm <sup>3</sup>	±1 %
NO <sub>2</sub>	0–10 ppmv	0.04 ppmv	0.04 mg/Nm <sup>3</sup>	0.1 mg/Nm <sup>3</sup>	±1 %
O <sub>2</sub>	0–25 %	0.03 %	0–25 %	0.03 %	±1 %
CO	0–50 ppmv	0.04 ppmv	0–60 mg/Nm <sup>3</sup>	0.05 mg/Nm <sup>3</sup>	±1 %
CO <sub>2</sub>	0–12 %	0–12 %	0–12 %	0.01 %	±1 %
SO <sub>2</sub>	0–200 ppm	0.2 ppmv	0–600 mg/Nm <sup>3</sup>	0.6 mg/Nm <sup>3</sup>	±1 %

\*Repeatability is ±1 % of reading or the Limit of Detection (LOD), whichever is greater.

## QCL Benefits for Continuous Emission Monitoring Systems (CEMS)

Rosemount QCL/TDL-based CEMS offers a unique and field-proven system to monitor up to twelve critical components gases and potential pollutants to ensure compliance and improved, overall operations.

- Robust, accurate CEMS delivers the speed and reliability operators demand to ensure global, national, state, and local level compliance
- Hybrid, multi-component QCL/TDL system offers the most comprehensive analysis available for detecting a range of components in both the near and mid-infrared spectral range
- Patented laser chirp technique used to identify and record thousands of measurements every second and ensures repeatable monitoring of emissions
- Unmatched reliability and accuracy of emissions
- No consumables and no in-field enclosure reduces cost and simplifies installation
- Easy and infrequent maintenance with auto validation and/or calibration
- Sample temperature up to 374 °F (190 °C) to keep hot/wet sample above acid dew point when required

## Recommended Technology



### Rosemount™ CT5100 Continuous Gas Analyzer

or

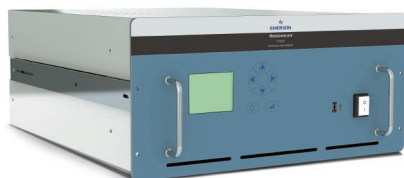

### Rosemount™ CT5400 Continuous Gas Analyzer

- Measure up to twelve components simultaneously
- Accurate and sensitive gas measurements
- Excellent linearity of response and repeatability
- Low, long term drift, extends calibration intervals
- Low maintenance and low lifetime costs
- Continuous health diagnostic reporting
- Embedded ARM processor for fully autonomous operation
- Intuitive, simple front panel user interface allows access to all instrument functions

# NO<sub>x</sub> Reduction – Fertilizer / Ammonia Slip



Nitrogen oxides (NO<sub>x</sub>) result from the combustion process in turbines, crackers, combustion engines, boilers, and other locations within a plant. As a powerful pollutant, it is important to control and contain NO<sub>x</sub> emissions. Both Selective catalytic/non-catalytic reduction (SCR and SNCR) are techniques used worldwide to remove NO<sub>x</sub>. However, this process can result in a byproduct of unreacted ammonia or ammonia slip. Continuous measurement and monitoring of ammonia slip can be a challenge to ensure sample integrity is maintained, especially in high dust, high-temperature applications.

## What's your challenge?



To adhere to environmental guidelines, operators must balance using the precise amount of ammonia – not enough results in waste, too much can lead to emissions.

## What's your opportunity?



Capable, fast Rosemount QCL/TDL technology delivers the needed measurement precision (0–100 ppm) to ensure production is at its optimum and avoid overdosing issues that result in both economic and environmental problems and cost.

## Typical NO<sub>x</sub> Reduction Process

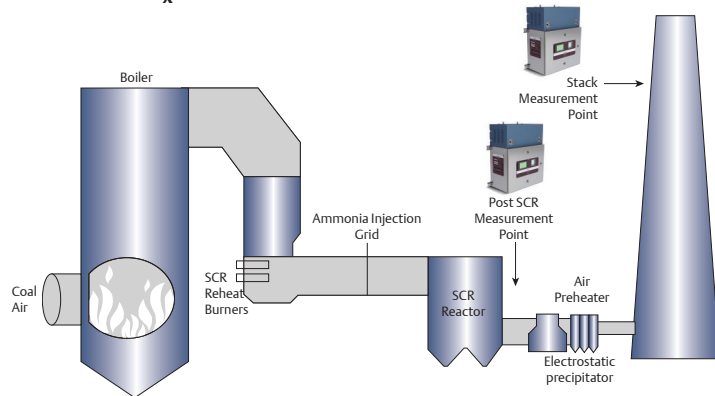

## Measurement Ranges

Component	Measurement Range				
	Range	LOD	Range	LOD	Repeatability*
NO	0–200 ppmv	0.2 ppmv	0–250 mg/Nm <sup>3</sup>	0.3 mg/Nm <sup>3</sup>	±1 %
NO <sub>2</sub>	0–100 ppmv	0.05 ppmv	0–200 mg/Nm <sup>3</sup>	0.1 mg/Nm <sup>3</sup>	±1 %
N <sub>2</sub> O	0–200 ppmv	0.2 ppmv	0–400 mg/Nm <sup>3</sup>	0.4 mg/Nm <sup>3</sup>	±1 %
NH <sub>3</sub>	0–100 ppmv	0.1 ppmv	0–75 mg/Nm <sup>3</sup>	0.1 mg/Nm <sup>3</sup>	±1 %

\*Repeatability is ±1 % of reading or the Limit of Detection (LOD), whichever is greater.

## QCL Benefits for NO<sub>x</sub> Reduction and Ammonia Slip Detection

Rosemount Quantum Cascade Lasers monitor ammonia slip to avoid the formation of damaging ammonia salts downstream or emission of ammonium chloride or gaseous ammonia, and the regulator fines and penalties that result.

- Interference-free monitoring of the presence of ammonia slip in the toughest environments
- Thousands of measurements per second are recorded using patented laser chirp technique ensures identification of even trace levels of ammonia
- Ammonia slip detection and insight into the efficiency of the plant's NO<sub>x</sub> reduction system resulting from real-time measurement and analysis
- Rugged, modular design delivers outstanding reliability and measurement stability in extreme operations
- Monitor up to twelve critical component gases for all industrial applications, toxic gas detection, and plant-wide emissions monitoring
- No consumables, no calibration, and no in-field enclosure or shelters reduce cost and simplify maintenance and upgrades

## Recommended Technology



### Rosemount™ CT5100 Continuous Gas Analyzer

or

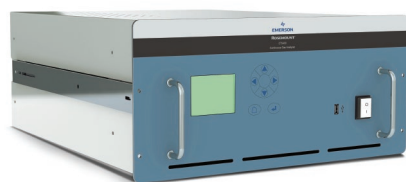

### Rosemount™ CT5400 Continuous Gas Analyzer

- Measure up to twelve components simultaneously
- Accurate and sensitive gas measurements
- Excellent linearity of response and repeatability
- Low, long term drift, extends calibration intervals
- Low maintenance and low lifetime costs
- Continuous health diagnostic reporting
- Embedded ARM processor for fully autonomous operation
- Intuitive, simple front panel user interface allows access to all instrument functions

# Natural Gas Quality



Natural gas is principally composed of methane but also includes amounts of higher value hydrocarbons, additional gases, water, and other impurities. The identification and removal of impurities are critical as contaminants can degrade process efficiency, raise cost, encourage corrosion damage, and increase risk. The ample supply of natural gas, and resulting transportation and storage demands, magnify the challenges operators face in the natural gas quality process.

## What's your challenge?



Operators must be able to ensure the composition of gas delivered – and received – is of sufficient quality per contractual fiscal agreements, pipeline requirements, and safety considerations.

## What's your opportunity?



Rosemount QCL/TDL provides rapid, reliable, high accurate measurement to ensure natural gas meets quality standards and specifications, does not contain impurities that react and can corrode pipelines, and avoids any combustion or safety concerns downstream.

## Typical Natural Gas Quality Process

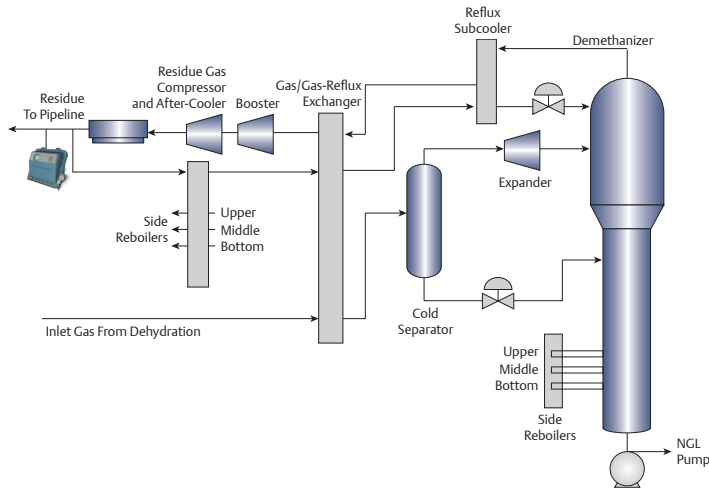

## Measurement Ranges

Component	Measurement Range		
	Range	LOD	Repeatability*
H <sub>2</sub> O	0–2500 ppm	5.0	±1 %
CO <sub>2</sub>	0–20 %	0.04	±1 %
H <sub>2</sub> S (coming soon)	0–100 ppm	0.5	±1 %

\*Repeatability is ±1 % of reading or the Limit of Detection (LOD), whichever is greater.

## QCL Benefits for Natural Gas Quality

Natural gas is required to meet stringent quality controls to satisfy fiscal and contractual obligations and ensure safe transportation. Rosemount Quantum Cascade Lasers offer fast and reliable monitoring of natural gas impurities to ensure quality standards are met and to avoid problems within the process or downstream.

- Rapid, indirect, and interference-free surveillance and detection of H<sub>2</sub>O, H<sub>2</sub>S, and CO<sub>2</sub> in the natural gas stream
- Unmatched sensitivity and real-time measurement detect a variety of components and impurities, including complex mixtures and changes in methane levels
- Patented laser chirp technique analyzes natural gas continuously down to low ppm concentrations, to provide sub-second measurements
- Outstanding reliability and stability in the most extreme of conditions and operations
- No consumables, no calibration, and no in-field enclosure or shelters reduce cost and simplify maintenance and upgrades
- Easy-to-use instrumentation and fast technician training

## Recommended Technology

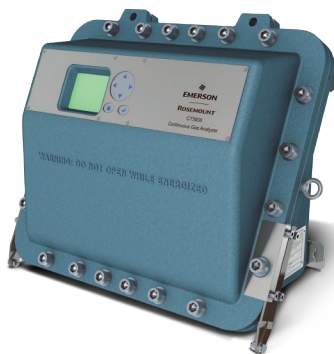

### Rosemount™ CT5800 Continuous Gas Analyzer

- Unique cell design delivers highly accurate measurement of low concentrations of impurities in gas streams
- Designed for up to six Quantum Cascade Lasers
- Multi-component and simultaneous measurement in a single gas analyzer
- Ideal for nitrogen stream and hydrogen stream purity applications
- Flameproof enclosure for hazardous area applications

# Hydrogen / Nitrogen Purity



Assuring hydrogen and nitrogen gas purity is critical across multiple processing industries and applications. For several key processes, the purity of the gas must be precisely monitored and controlled to ensure the product is within specification and avoid damage to equipment or process line. The purity of these gases also plays an important role in controlling reactions and reactor performance, avoiding contaminating valuable catalysts, and ensuring the efficiency of the synthesis process and resulting product quality.

## What's your challenge?



The success and profitability of many gas processing industries and applications relies on the accurate and reliable detection and removal of gas impurities in each stage of the reaction process.

## What's your opportunity?



Rosemount QCL/TDL technology delivers extremely fast and highly accurate measurement identification and analysis of gas impurities in a single analyzer instrument.

## Typical H<sub>2</sub> / N<sub>2</sub> Purity Process

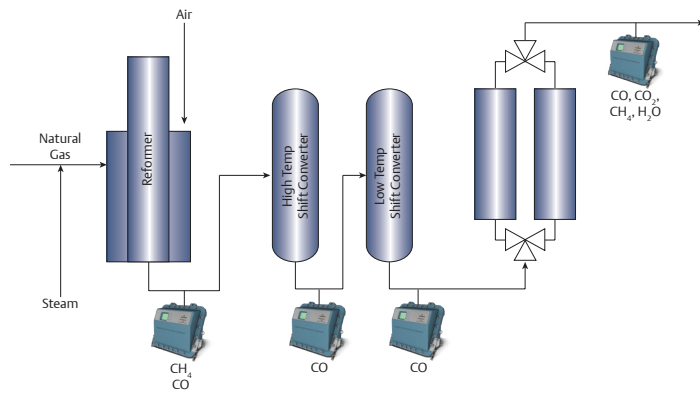

## Measurement Ranges

Component	Measurement Range		
	Range	LOD	Repeatability*
CO	0–5 ppm	0.05	±1 %
CO <sub>2</sub>	0–5 ppm	0.02	±1 %
H <sub>2</sub> O	0–10 ppm	0.1	±1 %
CH <sub>4</sub>	0–50 ppm	0.5	±1 %
NH <sub>3</sub>	0–10 ppm	0.05	±1 %

\*Repeatability is ±1 % of reading or the Limit of Detection (LOD), whichever is greater.

## QCL Benefits for Hydrogen / Nitrogen Purity

The use of high-purity hydrogen and nitrogen gases is vital to avoid equipment plugging and resulting damage, ensure proper catalyst integrity and reactions, and achieve improved process performance. Rosemount QCL/TDL lasers deliver real-time monitoring performance using a single analyzer device for increased process efficiency and minimized cost.

- Multiple QCL/TDL lasers in a single analyzer for ultrafast detection and analysis of NH<sub>3</sub>, CO, and CO<sub>2</sub>, Methane, and moisture
- Analysis time of <1 second delivers critical purity monitoring and identification performance
- Unmatched sensitivity and real-time measurement detect a variety of components and impurities, even in complex mixtures
- Patented laser chirp technique analyzes natural gas continuously down to low ppm concentrations, to provide sub-second measurements
- No consumables, no calibration, and no in-field enclosure or shelters reduce cost and simplify maintenance and upgrades
- Easy-to-install instrumentation and fast technician training

## Recommended Technology



### Rosemount™ CT5800 Continuous Gas Analyzer

- Unique cell design delivers highly accurate measurement of low concentrations of impurities in gas streams
- Designed for up to six Quantum Cascade Lasers
- Multi-component and simultaneous measurement in a single gas analyzer
- Ideal for nitrogen stream and hydrogen stream purity applications
- Flameproof enclosure for hazardous area applications

# Rosemount™ CT5000 QCL Series Analyzers

## Rosemount™ CT5100 Continuous Gas Analyzer

The Rosemount CT5100 continuous gas analyzer is the first Quantum Cascade Laser (QCL) system developed for process gas analysis and emissions monitoring. The CT5100 is available in two variants: a certified system, housed in a purged and pressurized enclosure for hazardous area installations (illustrated); and a non-certified system for use in non-hazardous areas. Both can house up to six lasers to measure multiple components in the gas stream simultaneously. The laser arrangement consolidates the measurement requirements into a single gas analyzer.



## Rosemount™ CT5400 Continuous Gas Analyzer

The Rosemount CT5400 is a multi-component QCL/TDL analyzer designed for laboratory and gas processing applications. Extremely versatile and configurable, it can hold up to six laser modules and measure up to twelve components simultaneously with an enhanced dynamic range from sub ppm to % levels.

The CT5400 is ideal for environmental monitoring and can detect NO<sub>x</sub>, SO<sub>x</sub>, CO, CO<sub>2</sub>, CH<sub>4</sub>, NH<sub>3</sub>, O<sub>2</sub>, HF and HCl.



## Applications

- Process Gas Analysis
- Continuous Emissions Monitoring Systems (CEMS)
- Ammonia Slip

## Features & Benefits

### Multi-component QCL/TDL analyzer

- Measure up to twelve components simultaneously
- Accurate and sensitive gas measurements
- Excellent linearity of response and repeatability
- Low, long term drift, extends calibration intervals
- Low maintenance and low lifetime costs
- Continuous health diagnostic reporting
- Embedded ARM processor for fully autonomous operation
- Intuitive, simple front panel user interface allows access to all instrument functions

### Field serviceable and field configurable

- Interchangeable modular configuration for up to six lasers

## Applications

### Sample cell and simple handling configurable to suit your application needs:

- Processor monitoring
- Continuous Emissions Monitoring Systems (CEMS)
- Continuous Ambient Monitoring Systems (CAMS)
- DeNO<sub>x</sub>/SCR
- Ammonium nitrate precursors
- Other applications available on request

## Features & Benefits

### Multi-component QCL/TDL analyzer for laboratory and process analytics

- Measure up to twelve components simultaneously
- Low maintenance and low lifetime cost
- Enhanced dynamic range from sub ppm to %
- Embedded ARM processor for fully autonomous intelligent operation
- Intuitive, simple front panel user interface allows access to all instrument functions

### Field serviceable and field configurable

- Interchangeable modular configuration for up to six lasers



## Rosemount™ CT5800 Continuous Gas Analyzer

A unique cell design enables the CT5800 to deliver highly accurate measurement of low concentrations of impurities in gas streams. The device can have up to six Quantum Cascade Lasers to measure multiple components simultaneously in a single gas analyzer and is ideal for nitrogen stream and hydrogen stream purity applications. The CT5800 is designed for hazardous areas with a flameproof enclosure.



## Engineered Sample Handling Systems

A process gas analyzer is only as good as the quality of the sample it measures, which is why Emerson provides custom-engineered sample handling systems designed to meet the application's specifications and is rigorously tested before it ships to the customer.

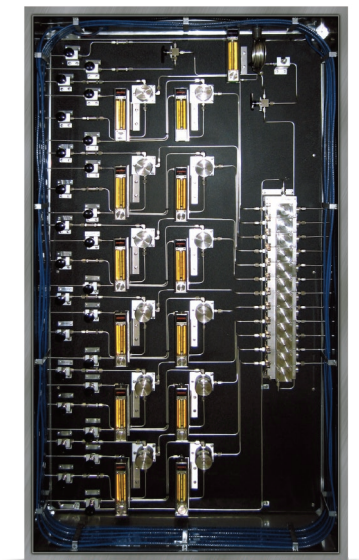

## Applications

**Process gas stream purity applications including:**

- Hydrogen purity
- Nitrogen purity
- Ethylene purity

## Features & Benefits

**Multi-component QCL analyzer**

- Measure up to twelve components simultaneously
- Accurate and sensitive gas measurements
- Excellent linearity of response and repeatability
- Low, long term drift, extends calibration intervals
- Low maintenance and low lifetime costs
- Continuous health diagnostic reporting
- Embedded ARM processor for fully autonomous operation
- Intuitive, simple front panel user interface allows access to all instrument functions

**Field serviceable and field configurable**

- Interchangeable modular configuration for up to six lasers

## Features & Benefits

**Typical features include**

- Heated and open-panel designs
- All components rated for the area classification
- Automatic calibration/validation available as an option
- Variety of sample probes to extract a reliable and stable sample from the process
- Other specifications and custom engineered as needed

# Rosemount™ CT5000 QCL Series Specifications

Specifications	CT5100	CT5400	CT5800
----------------	--------	--------	--------

For a complete list of product specifications, please refer to the individual Product Data Sheet.

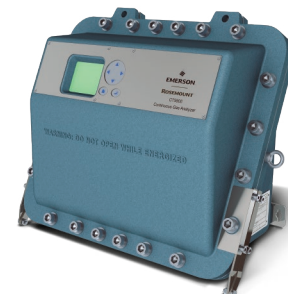
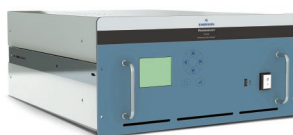

<b>Area Certification</b>	North America: Class I, Division 2 Groups A, B, C, D, T3 Europe: ATEX II 3G Ex p Group IIC T3	General purpose – safe area analyzer	North America: Class I, Division 2 Groups B, C, D, T4 Europe: ATEX II 2G Ex IIB + H <sub>2</sub> T4
<b>Performance</b>			
Repeatability	±1 % of reading	±1 % of reading	±1 % of reading
Linearity	R <sup>2</sup> > 0.999	R <sup>2</sup> > 0.999	R <sup>2</sup> > 0.999
Measurement Rate*	1 Hz (up to 10 Hz on request)	1 Hz (up to 10 Hz on request)	1 Hz (up to 10 Hz on request)
<b>Environmental</b>			
Ambient Temperature*	-20 °C to 55 °C (-4 °F to 131 °F)	0 °C to 45 °C (32 °F to 113 °F)	-20 °C to 55 °C (-4 °F to 131 °F)
Sample Gas Temperature	Up to 374 °F (190 °C) factory set	Up to 374 °F (190 °C) factory set	Ambient
Humidity Range	Max. 95 % RH	Max. 95 % RH	Max. 95 % RH
Protection Class	IP66/NEMA 4X (main enclosure)	n/a	IP66/NEMA 4X
<b>Communications</b>			
Analog Signal Out*	4–20 mA (1 per measurement)	4–20 mA (1 per measurement)	4–20 mA (1 per measurement)
Protocols	Modbus (over Ethernet TCP/IP, RS-232 or RS485)	Modbus (over Ethernet TCP/IP, RS-232 or RS485)	Modbus (over Ethernet TCP/IP, RS-232 or RS485)
Inlet Gas Connector**	¼ in. (6 mm) Swagelok type	¼ in. (6 mm) Swagelok type	¼ in. (6 mm) Swagelok type
Outlet Gas Connector**	¼ in. (6 mm) Swagelok type	¼ in. (6 mm) Swagelok type	¼ in. (6 mm) Swagelok type
<b>Utilities</b>			
Power Supply	110 VAC 60 Hz / 240 VAC 50 Hz	110 VAC 60 Hz / 240 VAC 50 Hz	110 VAC 60 Hz / 240 VAC 50 Hz
<b>Mechanical</b>			
Size	50.8 x 25.4 x 61 cm [L x W x H] 20 x 10 x 24 in	48.26 x 65.32 x 22.15 cm [L x W x H] 19 x 26 x 9 in	61 x 29.21 x 51.20 cm [L x W x H] 24 x 11-½ x 20 in
Weight	53 kg (116.8 lbs.)	30 kg (66 lbs.)	73 kg (160 lbs.)
Installation	Wall Mount	19" Rack Mount	Wall Mount or Rack Mount

# Service and Support

## Lifecycle Services & Support

Our team of trained and certified field experts know and understand the requirements needed to develop a customized service program to suit your application. We provide complete turn-key services and problem solving to assist you every step of the way. From pre-installation services to on-going maintenance and support long after commissioning, we have the expertise to ensure your Rosemount analyzers runs at ideal operating conditions during its lifecycle.

Field services include, but are not limited to the following:

- Startup and commissioning
- Scheduled maintenance
- On-site support
- Field retrofits
- Training



## Training Services

Whether your goal is to reduce maintenance costs, or maximize up-time, or reduce lost and unaccounted for gas running through the pipeline, Emerson offers a complete list of training courses and continuous support programs to ensure your technicians know how to properly operate and maintain the analyzer during its lifecycle.

Our certified instructors offer two types of training courses:

**Standard Training** programs are scheduled periodically throughout the year at one of our four training facilities. Each course varies in length, typically lasting between four to eight hours a day for a period of four days, depending on the course level and student knowledge and experience. These classes are designed to expand a student's knowledge, covering such topics as how to properly configure the instruments to meet the plant's monitoring and control needs, how to properly calibrate and care for them, and how to use diagnostic variables to troubleshoot problems and schedule routine maintenance.

**Private Training** classes can also be arranged at an off-site location depending on availability and training location requested. Training is conducted in both a formal classroom setting and a hands-on instructional approach to give customers a complete training program customized to their specific needs and interests.

All standard and private training courses are taught by Emerson certified instructors who work with each student to provide the necessary hands-on training, theory, and conceptual knowledge needed to perform on-the-job functions safely and accurately.

The instructor will prepare a course curriculum designed around the student's skill level and expertise, often covering everything from installation and startup, all the way through commissioning and long-term maintenance within the same class. For the more experienced student, advanced training courses are available. Typical students who attend our training program include plant personnel, analytical technicians, and field service engineers.

# Rosemount™ Quantum Cascade Laser Analyzers

Achieve unmatched gas monitoring performance and realize cost savings with the most advanced analysis technology in the industry.

## EmersonProcess.com/GasAnalysis

 [Analyticexpert.com](http://Analyticexpert.com)

 [Twitter.com/Rosemount\\_News](https://twitter.com/Rosemount_News)

 [YouTube.com/user/RosemountAnalytical](https://www.youtube.com/user/RosemountAnalytical)

 [Facebook.com/Rosemount](https://www.facebook.com/Rosemount)

©2016 Emerson Process Management. All rights reserved.

### Emerson Process Management

Cascade Technologies  
Glendevon House  
Castle Business Park  
Stirling, FK9 4TZ  
Scotland  
T + 44 1786 447 721  
F + 44 1786 475 822  
[QCL.CSC@Emerson.com](mailto:QCL.CSC@Emerson.com)

The Emerson logo is a trademark and service mark of Emerson Electric Co. Rosemount and the Rosemount logotype are registered trademarks of Rosemount Inc. All other marks are the property of their respective owners.

The contents of this publication are presented for information purposes only, and while effort has been made to ensure their accuracy, they are not to be construed as warranties or guarantees, express or implied, regarding the products or services described herein or their use or applicability. All sales are governed by our terms and conditions, which are available on request. We reserve the right to modify or improve the designs or specifications of our products at any time without notice.

**ROSEMOUNT™**

  
**EMERSON™**  
Process Management