

APPVL INST CDM100 IECEX
EB-20023139
Revision: AA
Number of Pages: 13
Comments:

THIS COMPONENT MUST COMPLY WITH REGULATORY AGENCY REQUIREMENTS. NO CHANGES ARE ALLOWED WITHOUT PRIOR AUTHORIZATION FROM APPROVALS ENGINEERING.

Originator: RCS 10/05/12

Approved: RCS 10/05/12

Rev	ECN	Description	Approval	Date
AA	1049085	Release to Approvals	RCS	10/9/12



Equipment type **Meter type CDM100 *****(E or I)*******

Manufactured and submitted for examination **Micro Motion, Inc.**

Address **Boulder, Co. 80301, USA**

Standard basis IEC 60079-0:2011 General requirements
IEC 60079-1:2007 Flameproof enclosure 'd'
IEC 60079-11:2011 Intrinsic safety 'i'

Code for type of protection **Ex ib IIC T1-T4/T6 Gb IP66**
or
Ex d [ib] IIC T1-T6 Gb IP66

IECEX Certificate of Conformity **IECEX BVS 13.0041 X**



1) Subject and Type

Meter type CDM100*****

Instead of the *** letters and numerals will be inserted which characterize the following modifications:

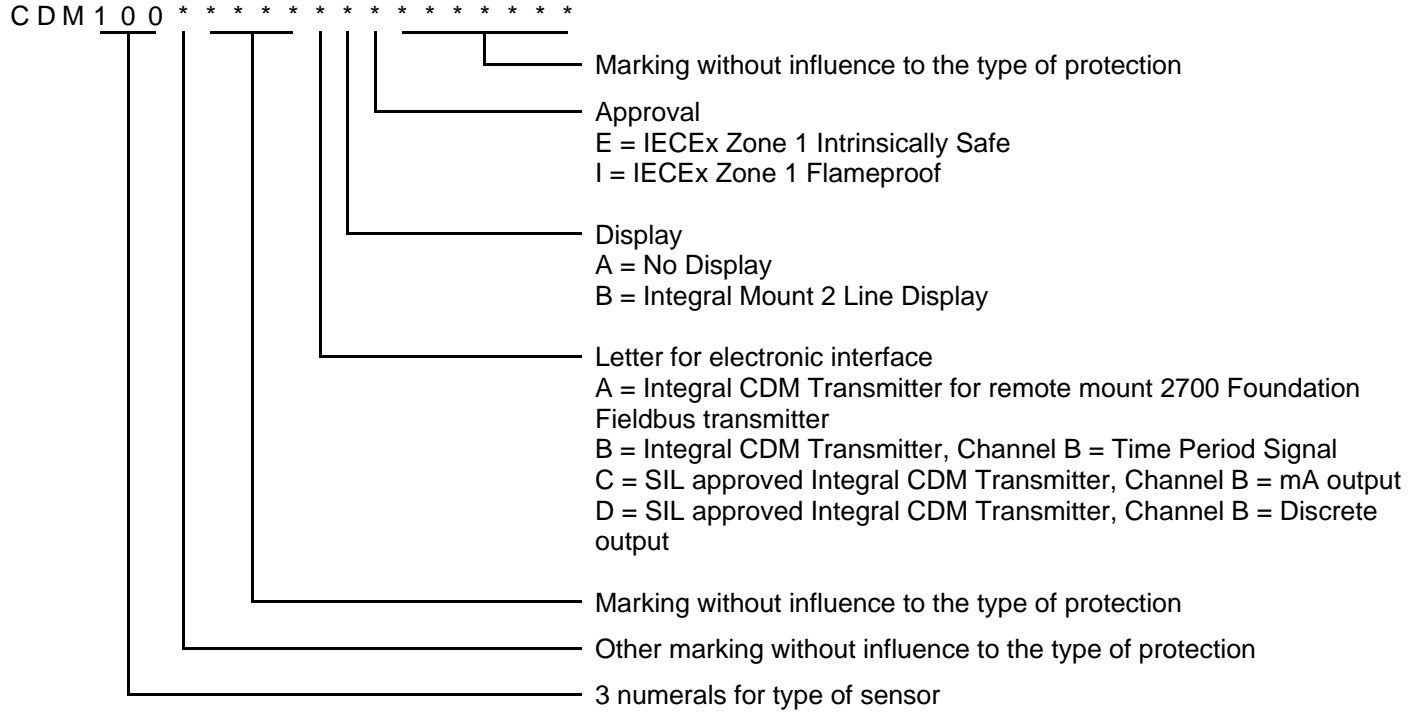

2) Description

The CDM100 flow sensor is used in combination with the CDM Density transmitter for Density measurement, forming a Liquid Density Meter.

The flow sensor, which consists of magnetically excited oscillating tubes, contains as electrical components coils, resistors, temperature sensors and terminals and connectors.

The CDM Density transmitter has its own certificate IECEX BVS 13.0009 X.

When used with an integral CDM Density transmitter, the variation gets the denomination type CDM100*****.



Meter type	
CDM100*****(B,C,D)AI*****	Ex d [ib] IIC T1-T6 Gb
CDM100*****(A,B,C,D)AE*****	Ex ib IIC T1-T6 Gb
CDM100*****(B,C,D)BE*****	Ex ib IIC T1-T4 Gb

Modifications to the design which have impact on the electrical parameters are indicated by a Construction Identification Code (CIC). This code consists out of two digits, starting with an A and followed by a sequence number; for example A4. The CIC can be found on the approval label, see picture below:

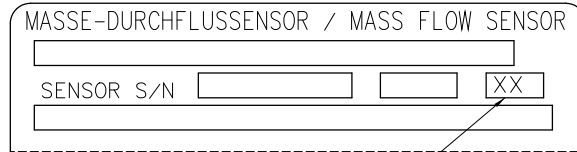

CONSTRUCTION
IDENTIFICATION CODE (CIC)
(SHOWN APPROXIMATELY
WHERE SHOWN)

3) Parameters

3.1. Type CDM100***** with integral CDM Density Transmitter

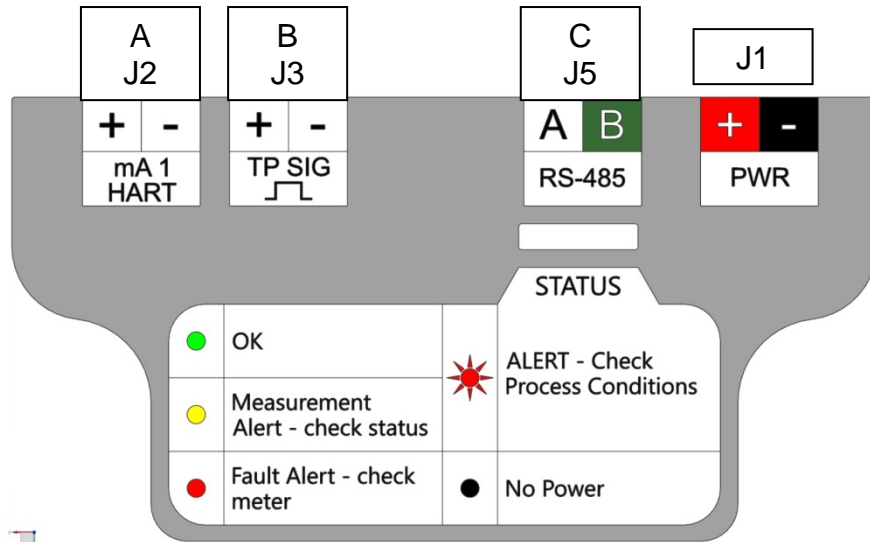

3.1.1. Electrical parameters CDM100*****(B,C,D)AI*****.

3.1.1.1 Non intrinsically safe main power supply (connector J1) :

Nominal voltage		DC	24V + 10 %
Maximum voltage	Um	AC/DC	250 V

3.1.1.2 Non intrinsically safe mA passive output with HART (Channel A, J2):

Nominal voltage		DC	24V +10%
Maximum voltage	Um	AC/DC	250 V

3.1.1.3 Non intrinsically safe configurable passive output; mA or DO or Time Period Signal Output (Channel B, J3)

Nominal voltage		DC	24V +10%
Maximum voltage	Um	AC/DC	250 V

3.1.1.4 Non intrinsically safe RS485 communication port (Channel C, J5)

Nominal voltage		DC	24V +10%
Maximum voltage	Um	AC/DC	250 V

3.1.1.5 Intrinsically Safe circuits [ib]: Drive-, Left Pick-Off-, Right Pick-Off- and Temperature element circuits.

3.1.2 Electrical parameters CDM100*****AAI*****, connected to Remote 2700 transmitter IECEX BVS 04.0006X.

When connected to a Micro Motion 2700 Transmitter, connectors J2 and J3 are not utilized.

3.1.2.1 Intrinsically safe main power supply (connector J1) :

Level of protection Ex ib IIC or Ex ib IIIC

voltage	Ui	DC	17,22	V
current	Ii		484	mA
power	Pi		2,05	W
max. internal capacitance	Ci			negligible
max. internal inductance	Li			negligible

3.1.2.2 Intrinsically safe RS485 communication port (connector J5)

Level of protection Ex ib IIC or Ex ib IIIC

3.1.2.2.1 for connection of an intrinsically safe circuit (linear) with the following values

voltage	Ui	DC	17,22	V
current	Ii		484	mA
max. internal capacitance	Ci		1	nF
max. internal inductance	Li			negligible

3.1.2.2.2 Level of protection Ex ib IIC or Ex ib IIIC

voltage	Uo	DC	9,51	V
current (instantaneous)	Io		480	mA
current (steady state)	I		106	mA
power	Po		786	mW
internal resistance	Ri		19,8	Ω

for group IIC

max. external capacitance	Co		85	nF
max. external inductance	Lo		25	μ H
max. external inductance/resistance ratio	Lo/Ro		31,1	μ H/ Ω

for group IIIC

max. external capacitance	Co		660	nF
max. external inductance	Lo		260	μ H
max. external inductance/resistance ratio	Lo/Ro		124,4	μ H/ Ω

3.1.3. Electrical parameters CDM100*****(B,C,D)(A,B)E*****

3.1.3.1 Intrinsically safe main power supply (connector J1) :

voltage	U _i	DC	30	V
current	I _i		484	mA
power	P _i		2,05	W
max. internal capacitance	C _i		0	μF
max. internal inductance	L _i		0	H

3.1.3.2 Intrinsically safe mA output with HART (Channel A, J2):

voltage	U _i	DC	30	V
current	I _i		484	mA
power	P _i		2,05	W
max. internal capacitance	C _i		0	μF
max. internal inductance	L _i		0	H

3.1.3.3 Intrinsically safe configurable output; mA or DO or Time Period Signal Output (Channel B, J3)

voltage	U _i	DC	30	V
current	I _i		484	mA
power	P _i		2,05	W
max. internal capacitance	C _i		0	μF
max. internal inductance	L _i		0	H

3.1.3.4 Intrinsically safe RS485 communication port (Channel C, J5)

3.1.3.4.1 for connection of an intrinsically safe circuit (linear) with the following values

voltage	U _i	DC	18	V
current	I _i		100	mA
max. internal capacitance	C _i		1	nF
max. internal inductance	L _i		negligible	

Level of protection Ex ib IIC

voltage	U _o	DC	9,51	V
current (instantaneous)	I _o		480	mA
current (steady state)	I		106	mA
power	P _o		786	mW
internal resistance	R _i		19,8	Ω

for group IIC

max. external capacitance	C _o		85	nF
max. external inductance	L _o		154	μH
max. external inductance/resistance ratio	L _o /R _o		31,1	μH/Ω

3.1.3.4.2 for connection of an intrinsically safe circuit (linear) with the following values

voltage	U _i	DC	17,22	V
current	I _i		484	mA
max. internal capacitance	C _i		1	nF
max. internal inductance	L _i		negligible	

Level of protection Ex ib IIC

voltage	U _o	DC	9,51	V
current (instantaneous)	I _o		480	mA
current (steady state)	I		106	mA
power	P _o		786	mW
internal resistance	R _i		19,8	Ω

for group IIC

max. external capacitance	C _o		85	nF
max. external inductance	L _o		25	μH
max. external inductance/resistance ratio	L _o /R _o		31,1	μH/Ω

3.1.4. Temperature class/ maximum surface temperature T.

The classification into a temperature class/determination of the maximum surface temperature T depends on the temperature of the medium taking into account the maximum operating temperature of the sensor and is shown in the following graphs:

3.1.4.1.

Meter type	
CDM100*****(B,C,D)AI*****	(IIC)

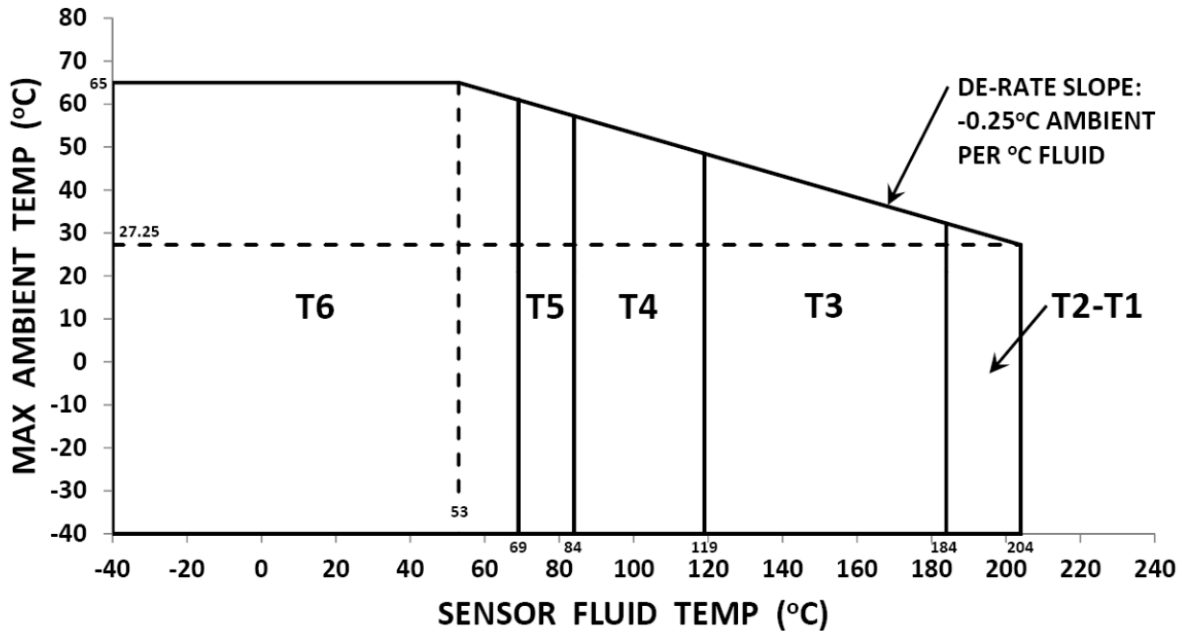

Note 1: Use the above graph to determine the temperature class for a given fluid and ambient temperature.

Ambient temperature range: Ta -40°C to +65°C.

3.1.4.2.

Meter type	
CDM100*****(A,B,C,D)AE*****	(IIC)

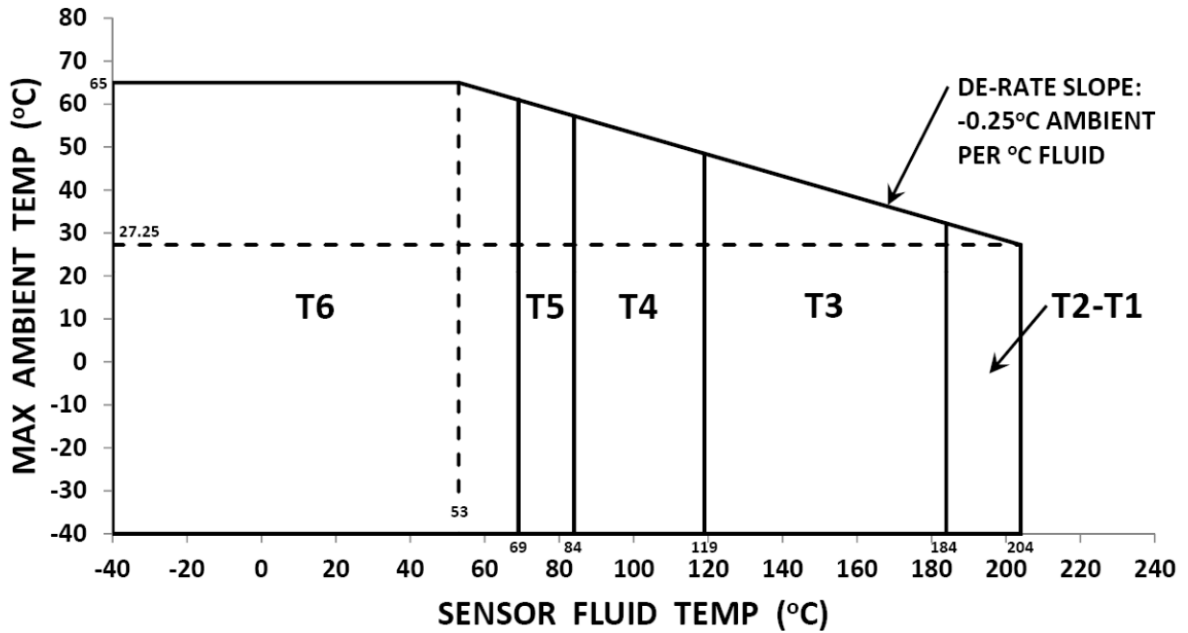

Note 1: Use the above graph to determine the temperature class for a given fluid and ambient temperature.

Ambient temperature range: Ta -40°C to +65°C.

3.1.4.3.

Meter type	
CDM100***** (B,C,D)BE*****	(IIC)

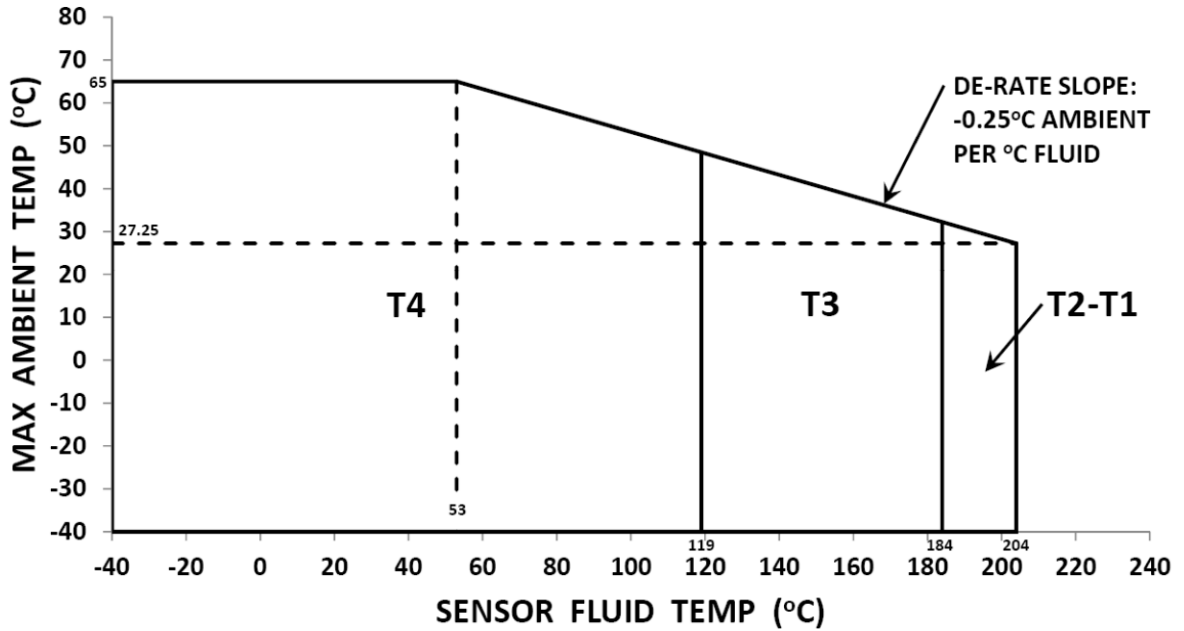

Note 1: Use the above graph to determine the temperature class for a given fluid and ambient temperature.

Ambient temperature range: Ta -40°C to +65°C.

4) Marking

The marking of the equipment shall include the following:

Type	Type of protection
CDM100*****(B,C,D)AI*****	Ex d [ib] IIC T1-T6 Gb
CDM100*****(A,B,C,D)AE*****	Ex ib IIC T1-T6 Gb
CDM100*****(B,C,D)BE*****	Ex ib IIC T1-T4 Gb

Ambient temperature range -40°C up to 65°C

5) Special conditions for safe use / Installation instructions

- 5.1 The permissible ambient temperature range is -40°C to +65°C. The use of the meter at an ambient temperature lower than -20°C is only admissible, if the cables are suitable and the cable entries resp. blanking plugs are certified for that temperature and use.
- 5.2 If certified conduit entries are used for the connection of the transmitter enclosure, the associated stopping boxes shall be installed immediately at the enclosure.
- 5.3 User Interface option is not allowed with model CDM100*****(A,B,C,D)AI*****; only with model CDM100*****(B,C,D)BE*****.