

Rosemount 3490 Series 4–20 mA + HART Compatible Controller

Quick Start Guide for Installation



HART
COMMUNICATION PROTOCOL

WARNING

Failure to follow safe installation guidelines could result in death or serious injury

- The Rosemount 3490 Series control unit (“control unit”) must not be installed in a hazardous area. The control unit can be connected to transmitters that are installed in a hazardous area
- Use the control unit only as specified in this guide and the product reference manual. Refer to the Rosemount 3490 Series Reference Manual (Document 00809-0100-4841) and Rosemount3490 Series Safety Manual (Document 00825-0200-4841) for more instructions
- The control unit must be installed, connected, commissioned, operated, and maintained by suitably qualified personnel only, observing national and local requirements that may apply

Electrical shock could cause death or serious injury

- Make sure that the control unit is not powered when removing the terminal cover and making terminal connections
- If the control unit is installed in a high voltage environment and a fault condition or installation error occurs, high voltage may be present on leads and terminals

Symbols used in this guide

Document Number

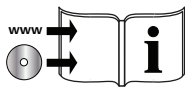

- Refer to numbered document on the supplied CD-ROM or on www.rosemount.com for further information.
- An electronic device with Adobe Acrobat software installed is needed to view the document contents.



- A default configuration for a control unit as shipped from the factory.



- Switch on/off power only to the control unit.

Required equipment

Standard tools e.g. screwdrivers and wire strippers/cutters.

Contents

Installation: Wall-mount (IP65) Unitpage 3
 Installation: Wall-mount (NEMA 4X) Unitpage 7
 Installation: Panel-mount Unit page 11

Installation: Wall-mount (IP65) Unit

Note

- The control unit must only be installed in a non-hazardous area (ordinary location), but it can be connected to transmitters installed in hazardous (classified) areas.

Mounting the (IP65) control unit

- The **wall-mount** control unit (IP65 box) is for inside or outside, but requires protection from direct sunlight, flooding, and heavy rain.



For safety, the wall or other mounting structure should support four times the 1.4 kg (mains power) or 1.0 kg (DC power) mass of the unit

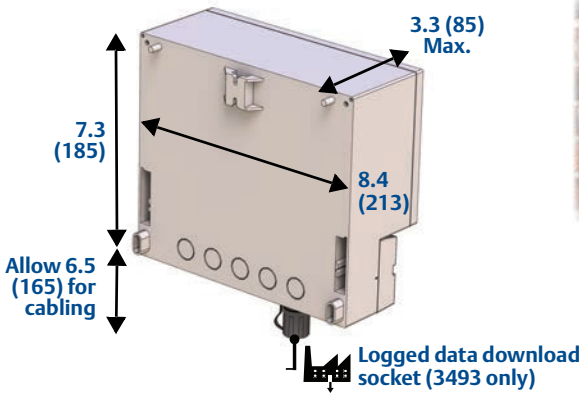

The cabinet and wall fixings are not supplied

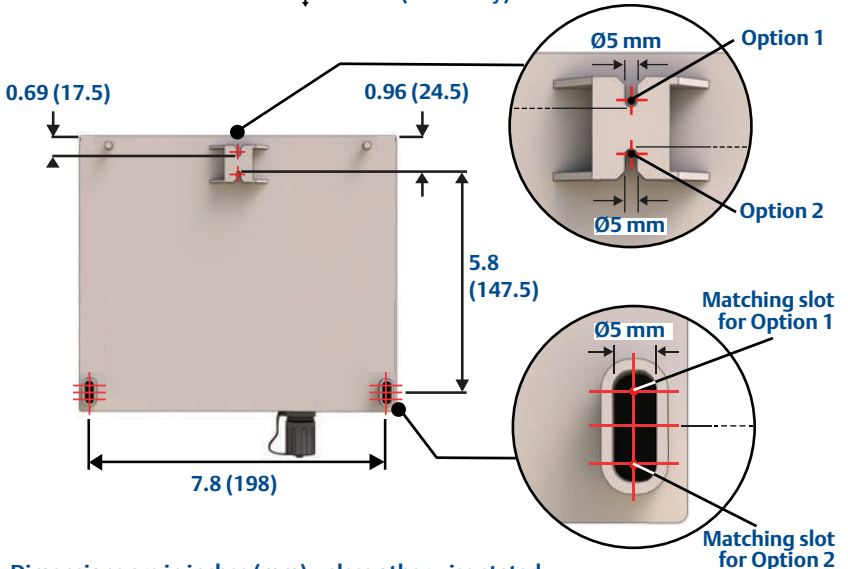

Note: Dimensions are in inches (mm) unless otherwise stated

Make the electrical connections

Wall-mount (IP65 box) cable glands and blanking/stopping plugs

1. Remove the terminal cover



3491/2



3493



Remove all transit caps if they are fitted

Do not remove the pre-fitted RS232 socket

Undo 2 x terminal cover screws

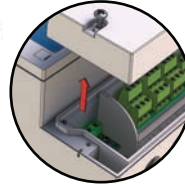
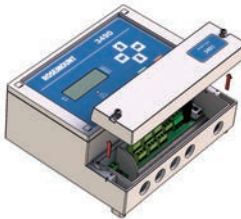
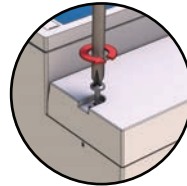
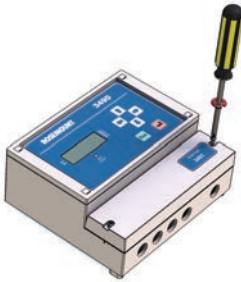

2. Fit cable glands (*supplied*) in the pre-drilled holes ready for cabling
3. Fit blanking/stopping plugs (*supplied*) in the unused holes

Cable glands (as supplied)



Blanking/stopping plugs (as supplied)



Wall-mount (IP65 box) power supply connections

1. Connect the mains 115/230 Vac or 24 Vdc supply (depending on the control unit):



Always switch off the power when doing these connections



Terminal 30 must be connected to an Intrinsically Safe Earth/Ground if the transmitter (wired to Terminals 1 and 2) is in a hazardous area

On a mains-powered unit:

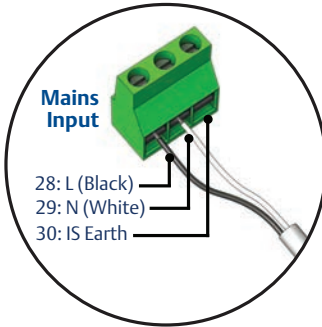

Set the voltage selection switch to 115 or 230 Vac



On a 24 Vdc-powered unit:

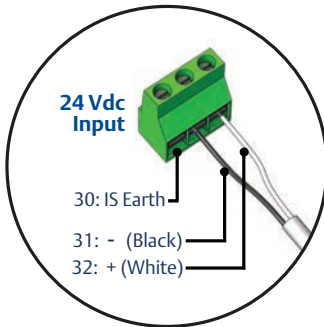

Note

- Laws and standards for electrical wiring vary from country to country. The colors shown for the flexible cable wiring shown in this QIG are for the United States of America. It is very important to check the local regulations for electrical wiring involving mains/wall power. If you have any doubts at all, get help from a qualified electrician.

Wall-mount (IP65 box) current input (transmitter) connections

1. Connect the *single* 4–20 mA or HART transmitter (to a Rosemount 3491 or 3493) or the *first* of two HART transmitters (to a Rosemount 3492 only):

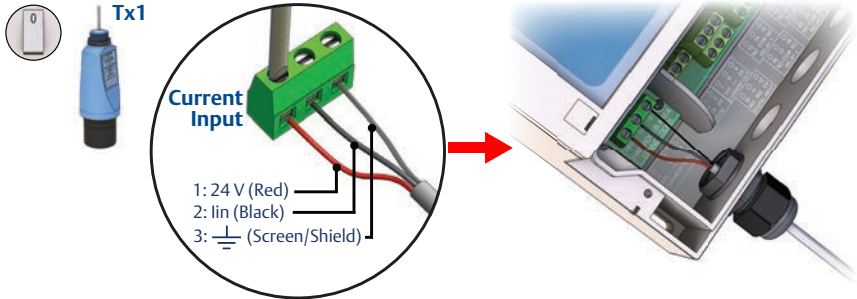

2. Power on, and respond to on-screen prompts until a measurement is displayed.
3. Connect the *second* HART transmitter (to a Rosemount 3492 only):

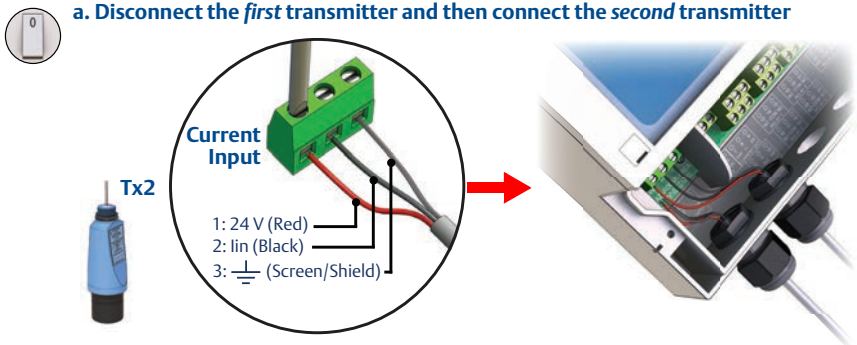

- a. **Disconnect the first transmitter and then connect the second transmitter**
- b. **Power on, and respond to on-screen prompts until a measurement is displayed.**

4. Re-connect the *first* HART transmitter (to a Rosemount 3492 only):

- a. **Connect the first transmitter again (do not disconnect the second transmitter).**

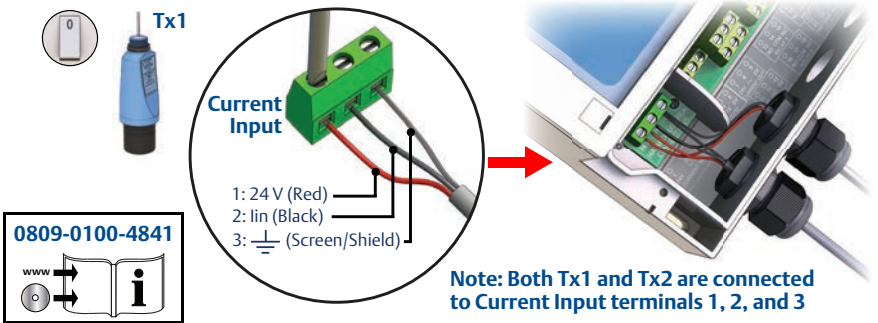

Note: Both Tx1 and Tx2 are connected to Current Input terminals 1, 2, and 3

- b. **Power on, and respond to on-screen prompts until a measurement is displayed.**

Installation: Wall-mount (NEMA 4X) Unit

Note

- The control unit must only be installed in a non-hazardous area (ordinary location), but it can be connected to transmitters installed in hazardous (classified) areas.

Mounting the (NEMA 4X) control unit

- The **wall-mount** control unit (NEMA 4X box) is for inside or outside, but requires protection from direct sunlight, flooding, and heavy rain.

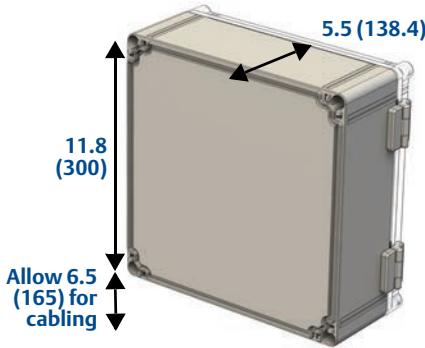

Note: Dimensions are in inches (mm) unless otherwise stated



For safety reasons, the wall or other mounting structure should support four times the 3.5 kg (mains power) or 3.1 kg (DC power) mass of the unit.

Select a screw length that is suitable for the type of mounting surface.

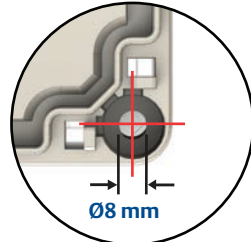
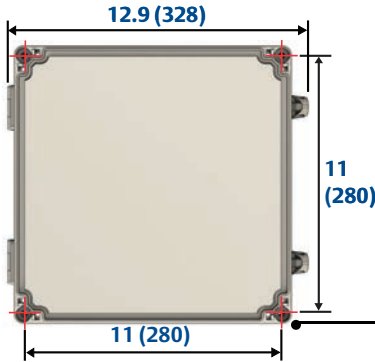

4 mounting holes

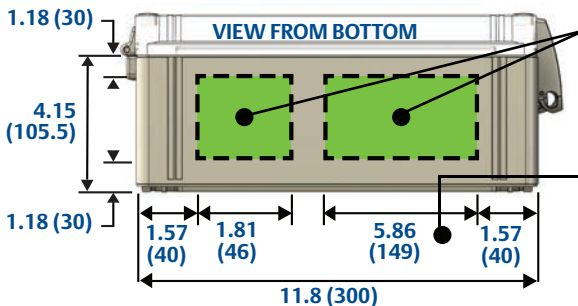

Holes can be drilled within these areas for cable glands (not supplied) to be fitted

This dimension is reduced to 3.9 in. (100 mm) on the 3493 because of the fitted RS232 data logging socket (see page 8)

Make the electrical connections

Wall-mount (NEMA 4X box) cable glands

1. Remove the terminal cover



Do not remove the factory pre-fitted RS232 data-download socket from the Rosemount 3493

Undo 4 x terminal cover screws



Carefully lift the terminal cover away from the enclosure. An Earth lead connects the terminal cover to the enclosure.

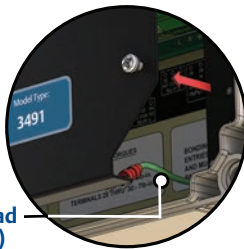

Earth lead (green)

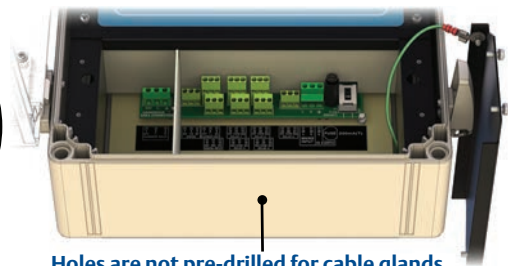

Holes are not pre-drilled for cable glands

2. If not already done so, drill holes for cable glands (see [page 7](#)).

Make an allowance for the factory pre-fitted RS232 data-download socket on the Rosemount 3493 control unit.

3. Fit cable glands (*not supplied*) in the new drilled holes, ready for cabling.



Wall-mount (NEMA 4X box) power supply connections

1. Connect the mains 115/230 Vac or 24 Vdc supply (depending on the control unit):



Always switch off the power when doing these connections



Terminal 30 must be connected to an Intrinsically Safe Earth/Ground if the transmitter (wired to Terminals 1 and 2) is in a hazardous area

On a mains-powered unit:

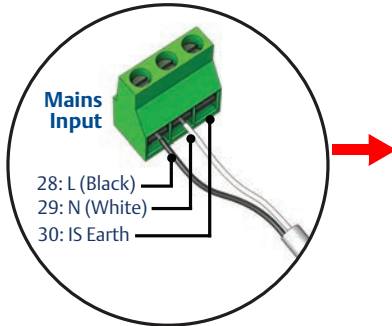

Set the voltage selection switch to 115 or 230 Vac

On a 24 Vdc-powered unit:

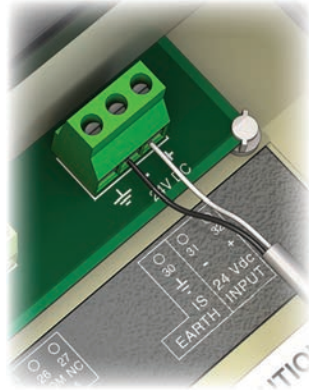
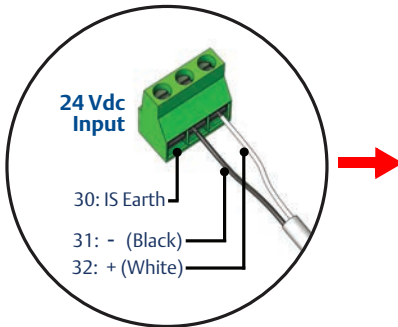

Note

- Laws and standards for electrical wiring vary from country to country. The colors shown for the flexible cable wiring shown in this QIG are for the United States of America. It is very important to check the local regulations for electrical wiring involving mains/wall power. If you have any doubts at all, get help from a qualified electrician.

Wall-mount (NEMA 4X box) current input (transmitter) connections

1. Connect the *single* 4–20 mA or HART transmitter (to a Rosemount 3491 or 3493) or the *first* of two HART transmitters (to a Rosemount 3492 only):

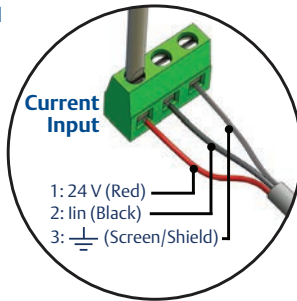

2. Power on, and respond to on-screen prompts until a measurement is displayed.
3. Connect the *second* HART transmitter (**to a Rosemount 3492 only**):



a. Disconnect the *first* transmitter and then connect the *second* transmitter.

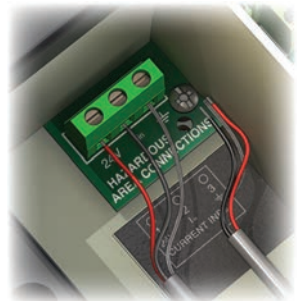
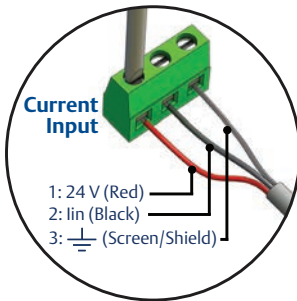

b. Power on, and respond to on-screen prompts until a measurement is displayed.

4. Re-connect the *first* HART transmitter (**to a Rosemount 3492 only**):



a. Connect the first transmitter again (do not disconnect the second transmitter).

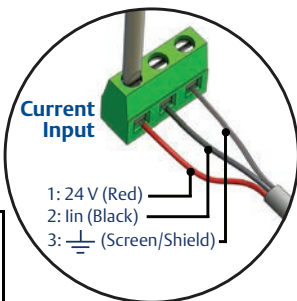

Note: Both Tx1 and Tx2 are connected to Current Input terminals 1, 2, and 3.

b. Power on, and respond to on-screen prompts until a measurement is displayed.

Installation: Panel-mount Unit

Mounting the control unit in a panel

- The **panel-mount** control unit is a standard DIN size, designed for direct mounting in a control room panel. It requires a weatherproof environment



For safety, the panel should be strong enough to support the 1.2 kg (mains power) or 0.8 kg (DC power) mass of the unit.

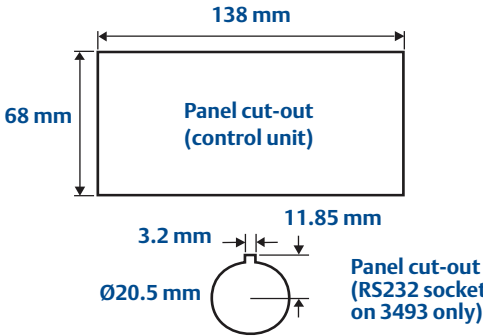

The panel (not supplied) can have a thickness of 1.5 to 10 mm

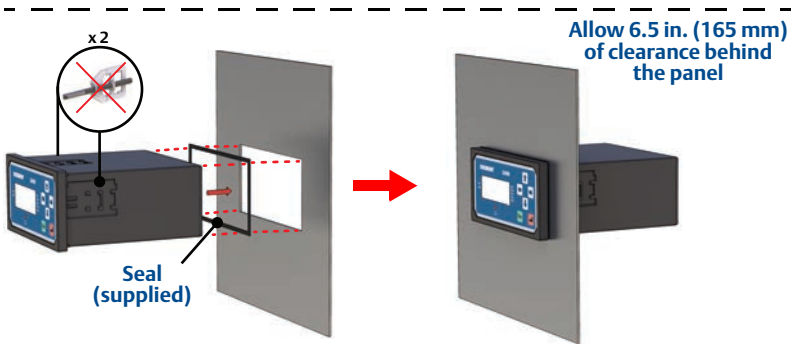

Attach a screw clip to each side of the control unit

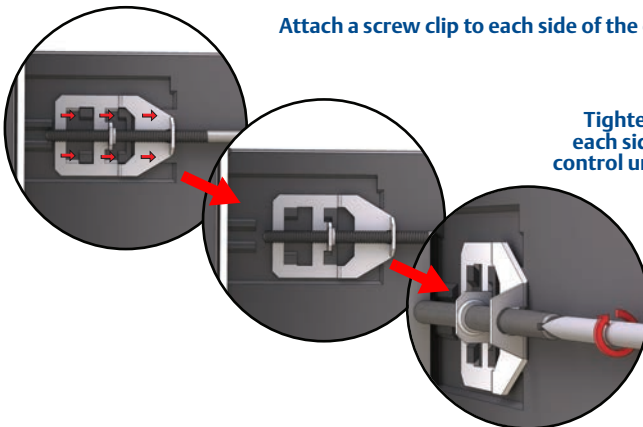

Make the electrical connections

- A logged data download (RS232) socket is supplied with the Rosemount 3493 panel-mount unit. (The socket is factory-fitted and pre-wired on wall-mount units)

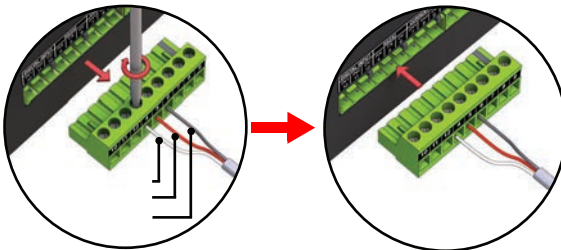
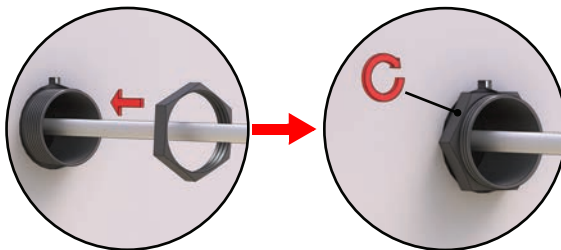
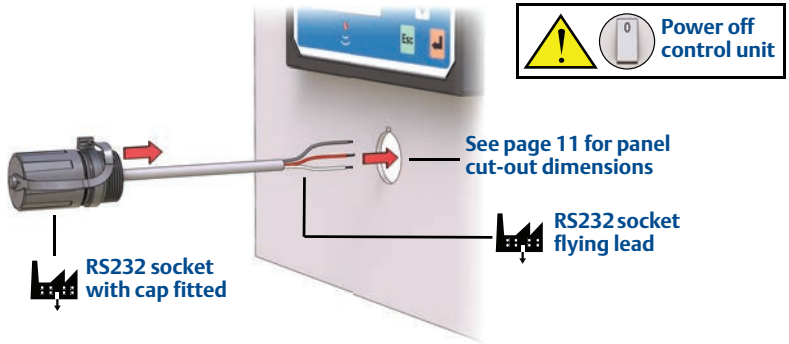

0809-0100-4841

- When there is data to be downloaded using Rosemount Logview or other software, connect the RS232 cable supplied with the socket

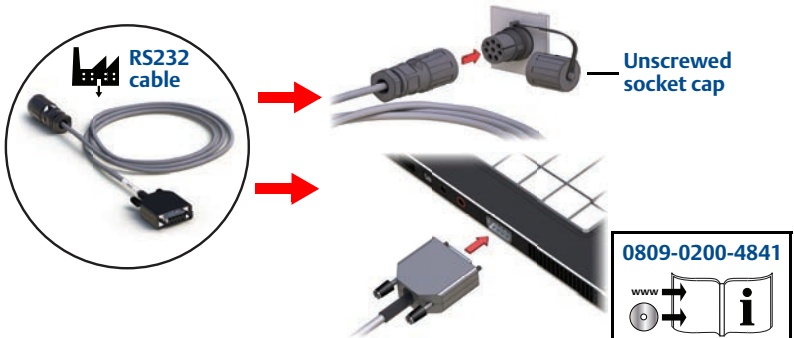

Panel-mount power supply connections

1. Connect the mains 115/230 Vac or 24 Vdc supply (depending on the control unit):

  **Always switch off the power when making these connections**

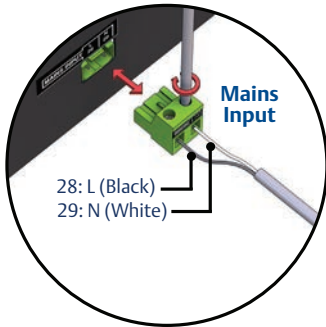

 **On a mains-powered unit, set the voltage selection switch to 115 or 230 Vac**

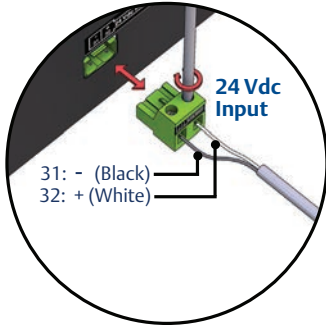
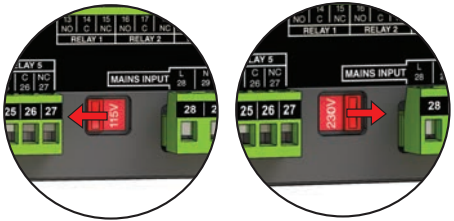

 **Terminal 30 must be connected to an Intrinsically Safe Earth/Ground if the transmitter (wired to Terminals 1 and 2) is in a hazardous area**

Note

- Laws and standards for electrical wiring vary from country to country. The colors shown for the flexible cable wiring shown in this QIG are for the United States of America. It is very important to check the local regulations for electrical wiring involving mains/wall power. If you have any doubts at all, get help from a qualified electrician.

Panel-mount current input (transmitter) connections

1. Connect the *single* 4–20 mA or HART transmitter (to a Rosemount 3491 or 3493) or the *first* of two HART transmitters (to a Rosemount 3492 only):

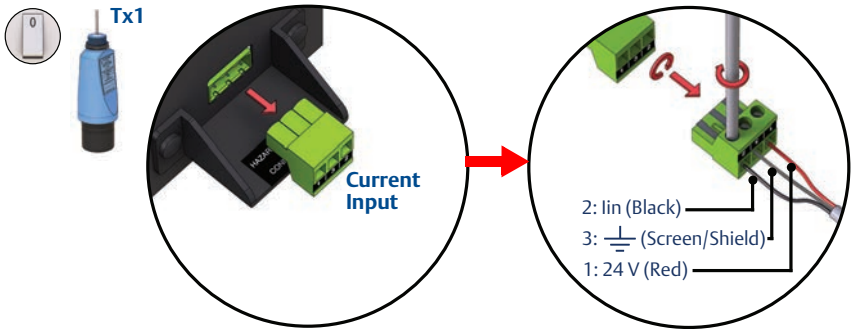

2. Power on, and respond to on-screen prompts until a measurement is displayed.
3. Connect the *second* HART transmitter (to a Rosemount 3492 only):

a. Disconnect the *first* transmitter.

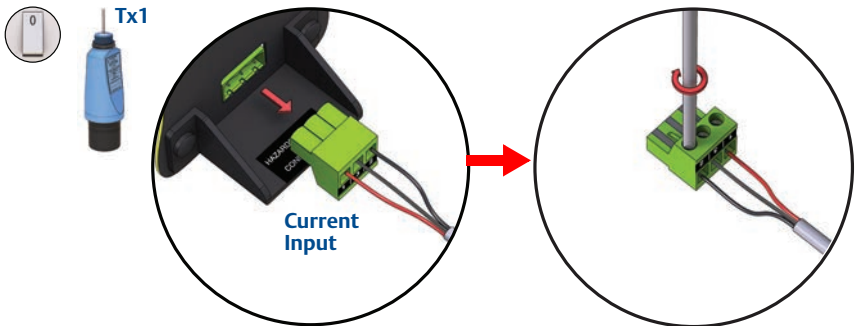

b. Connect the *second* transmitter.

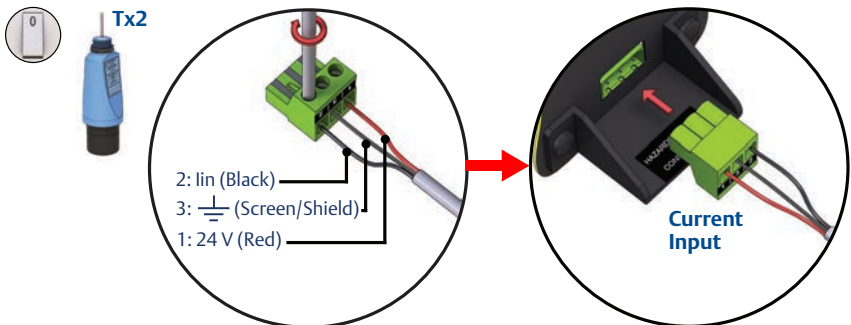

- c. Power on, and respond to on-screen prompts until a measurement is displayed.

4. Re-connect the *first* HART transmitter (to a Rosemount 3492 only):

a. Connect the *first* transmitter again (do not disconnect the second transmitter).

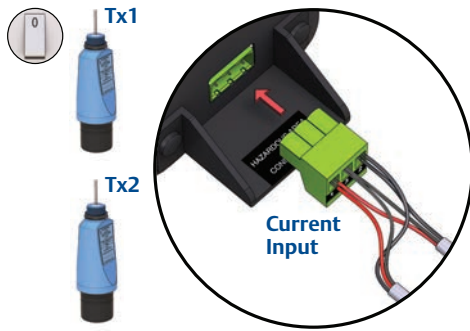
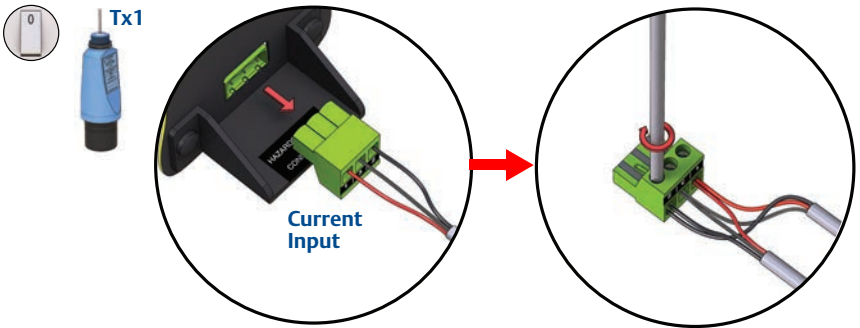

b. Power on, and respond to on-screen prompts until a measurement is displayed.

**Emerson Process Management
Rosemount Inc.**

8200 Market Boulevard
Chanhassen, MN USA 55317
T (US) (800) 999-9307
T (Intl) (952) 906-8888
F (952) 906-8889

**Emerson Process Management
Latin America**

1300 Concord Terrace, Suite 400
Sunrise Florida 33323 USA
T + 1 954 846 5030

**Emerson Process Management
Asia Pacific Private Limited**

1 Pandan Crescent
Singapore 128461
T (65) 6777 8211
F (65) 6777 0947/65 6777 0743

**Emerson Process Management
GmbH & Co. OHG**

Argelsrieder Feld 3
82234 Wessling Germany
T 49 (8153) 9390, F49 (8153) 939172

**Beijing Rosemount Far East
Instrument Co., Limited**

No. 6 North Street, Hepingli,
Dong Cheng District
Beijing 100013, China
T (86) (10) 6428 2233
F (86) (10) 6422 8586

© 2014 Rosemount Inc. All rights reserved. All marks property of owner.
The Emerson logo is a trade mark and service mark of Emerson Electric Co
Rosemount and the Rosemount logotype are registered trademarks of Rosemount Inc.